

DPU 2000R UCA TECHNICAL GUIDE

TG 7.11.1.7-52

Version 2.0

01 / 2004

b1

The following are trademarks of AEG Schneider Automation Inc.

Modbus® Modbus Plus®
Modicon®

IBM® , OS 2®, and IBM PC® are registered trademarks of International Business Machines Corporation.

The following are registered trademarks of the Microsoft Corporation:

Windows NT® Windows 3.1®
Windows 95® Windows 98®
Hyperterminal® MS-DOS®
Microsoft ®

USDATA® is a registered trademark of the USDATA Corporation.

PRICOM® and Power RICH® are registered trademarks of Asea Brown Boveri Incorporated.

LINUX©, is a copyright of its respective entity.

UNIX® is a trademark of its respective entity.

UCA® is a trademark of the Electric Power Research Institute EPRI.

Contents

Section 1 – Introduction

Introduction6

Section 2 – Communication Card Identification and Physical Port Characteristics

Communication Identification and Physical Port Characteristics9
 Communication Card Part Number Options11
 Unit Communication Card Verification.....14

Section 3 – DPU2000R Device Connectivity for Configuration and UCA Ethernet Ports

RS 232 Interface Connectivity16
 Port Isolation.....16
 RS 232 Handshaking Defined17
 RS 232 Cable Connectivity.....18
 Ethernet Connectivity.....20
 Fiber Optic Specifications21
 Copper Ethernet Specifications21

Section 4 – DPU2000R Device Parameterization

DPU2000R Device Parameterization22
 COM 0 Port (Front Port Configuration).....22
 COM Port 1 Options Settings (DPU2000R Only) [Catalog 587XXX00-XXX0 or 587XXX50-XXX0].....25
 Ethernet Protocol Parameter Visualizaion and Parameterization Procedure.....26
 Goose Messages.....28
 Verification of Communication29

Section 5 – UCA Object Description

Objected Modelled in the DPU2000R.....31
 Monitoring Objects32
 Device Identity (DI)32
 Global Values (GLOBE)32
 Metering – Polyphase Measurement Unit (MMXU).....33
 Metering – Sequence and Imbalance Metering (MSQI)33
 Metering – Polyphase Meter Unit (MMTR)35
 Metering – Demand Metering (MDMD)37
 Status.....38
 Instantaneous Overcurrent39
 Ground Time Overcurrent.....41
 Directional Overcurrent.....42
 Phase Balance Current Relay42
 Directional Power Relay43
 Under Voltage Relay44
 Over Voltage Relay.....44
 Control Objects45
 Circuit Breakers (XCBR).....45
 Reset Front Panel Fault Indicators / Reset of Sealed Outputs46
 Network Time Synchronization.....46
 GOOSE – Peer to Peer Communication46
 Post Fault Indication Objects.....46
 Last Fault Indication (FIND).....46
 Oscillographic Record Retrieval47
 Fault Record Retrieval.....50
 Operation Records.....51
 Appendix A - DPU Standard 10 Byte Protocol Document.....56

Tables

Section 1 – Introduction

Table 1-1. Protocol Capabilities Listed by Product Type.....8

Section 2 – Communication Card Identification and Physical Port Characteristics

Table 2-1. DPU2000 Communication Options12
 Table 2-2. DPU2000R Communication Card Matrix for Unit 587XXXXYZ-XXXXQ13
 Table 2-3. DPU2000R Communication Card Matrix14

Section 3 – DPU2000R Device Connectivity for Configuration and UCA Ethernet Ports

Table 3-1. Physical Interface Options.....16

Section 4 – DPU2000R Device Parameterization

Table 4-1. DPU2000R COM Port 0 Front Panel Interface Parameters.....22
 Table 4-2. WINECP Communication Port Settings25
 Table 4-3. COM Port 1 and COM Port 2 WINECP Port Setting Options25

Section 5 – UCA Object Description

Table 5-1. Device Identity Object Model Definition32
 Table 5-2. Global Variable Object Model Definition32
 Table 5-3. Polyphase Measurement Unit Object Model Definition.....33
 Table 5-4. Polyphase Meter Unit Object Model Definition35
 Table 5-5. Sequence and Imbalance Metering Object Model Definition36
 Table 5-6. Demand Metering Object Model Definition37
 Table 5-7. Instantaneous Overcurrent Object Model Definition39
 Table 5-8. Ground Overcurrent Object Model Definition41
 Table 5-9. Directional Overcurrent Object Model Definition42
 Table 5-10. Phase Balance Current Object Model Definition.....42
 Table 5-11. Directional Power Element Object Model Definition43
 Table 5-12. Under Voltage Element Object Model Definition.....44
 Table 5-13. Over Voltage Element Object Model Definition.....44
 Table 5-14. XCBR Control Object Model Definition45
 Table 5-15. Fault Indication Object Model Definition Supported in the DPU 2000R Ethernet UCA Board.....47
 Table 5-16. Operation Record Data51

Figures

Section 1 – Introduction

Figure 1-1. Distribution Protection Unit Product Family7

Section 2 – Communication Card Identification and Physical Port Characteristics

Figure 2-1. COM 0 Port Location.....9
 Figure 2-2. Physical Optional Communication Card Port Locations9
 Figure 2-3. DPU2000R Communication Cards10
 Figure 2-4. Physical Communication Card Location for the DPU2000R.....10

Section 3 – DPU2000R Device Connectivity for Configuration and UCA Ethernet Ports

Figure 3-1. Point to Point Architecture Using RS23217
 Figure 3-2. Multi-Drop Topology Using RS23218
 Figure 3-3. Classic DPU 2000R DB 9 RS 232 Cable Diagram18
 Figure 3-4. Enhanced OCI DPU 2000R DB 9 RS 232 Cable Diagram19
 Figure 3-5. Connection of a DB 25 Connector to a DPU 2000 or a DPU 2000R Classic Interface20
 Figure 3-6. Connection Diagram for Copper/Fiber Interfaces20
 Figure 3-7. Typical Hub/Switch Connection Using Fiber or Copper Ethernet21

Section 4 – DPU2000R Device Parameterization

Figure 4-1. Initial WINECP Communication Configuration Screen24
 Figure 4-2. Communication Port Setup Screen.....24
 Figure 4-3. COM Port 1 WIN ECP Setting Screen26
 Figure 4-4. WIN ECP Start Up Screen for Direct Access Attachment27
 Figure 4-5. Windows Settings Screen for Upload/Download of Settings27
 Figure 4-6. UCA Card Communication Parameter Screen28

Section 5 – UCA Object Description

Figure 5-1. UCA Object Implementation in an IED.....30
 Figure 5-2. UCA Object Philosophy.....30
 Figure 5-3. FTP COMTRADE File Upload48
 Figure 5-4. FTP Screen for Access of Fault, Oscillographic, and Operation Files Analysis48
 Figure 5-5. Oscillographic COMTRADE File Subdirectories49
 Figure 5-6. COMTRADE Files Available Using a Browser Utility49
 Figure 5-7. FTP Fault Record Archive in the UCA Server.....50
 Figure 5-8. Example Fault Record Text File Contents50
 Figure 5-9. Operation Record File Archival51
 Figure 5-10. Example Text File Illustrating the Operation Record Contents.....55

Section 1 - Introduction

With the introduction of a microprocessor based protective relay, today's relay protection engineer must be familiar with topics outside of traditional relaying schemes. It is intended that the production of this manual will enable the relay engineer to understand the principles of a microprocessor-based relay's inclusion in a substation automation project.

Substation automation is heavily dependent upon integration of the appropriate components to allow reporting of metering and event data. The foundation of a successful automation solution is thorough engineering of a communication system. The Distribution Protection Unit (DPU) is the culmination of intensive design efforts and relaying experience, which combine protective relaying and communication capabilities at an economical price. Through the evolution of protective relays, it was decided that a special manual needed to serve today's power automation specialist.

This manual is intended to give the reader an in-depth explanation of the communication interfaces available with the Distribution Protection Unit. Successful integration of microprocessor based relays like the DPU depends on not just understanding the bits and bytes of a particular protocol. It is the inherent understanding and application of such esoteric topics as physical interfaces, real time control, manufacturer independent device integration, throughput vs. speed of communication, ... which influences the success of an automation project.

In many cases the individual performing the SCADA integration is not a relay protection engineer. This manual departs from the standard type of relay manual in that each data type is explained and each bit, byte and word meaning is explained. Several application examples are given within each section. A description of each protocol command is illustrated for the benefit of the user. Appendices are included detailing application notes, which augment the text. An explanation of the product's physical interfaces and the connectivity required is explored in depth. Explanations of register's uses to increase overall throughput are also explored. Throughput is always an issue when the system is commissioned. Understanding ways to improve the system data update is explained.

Several steps are required to permit successful communication between devices:

1. Identification of the hardware components (Section 2).
2. Correct physical connection between devices (Section 3).
3. Correct device configuration of port protocol and operation parameters (Section 4).
4. Generation and interpretation of the protocol command strings (Section 5).

The following sections shall explore the following procedures in depth when establishing a communication automation system, utilizing the DPU 2000R.

The DPU, DPU 2000 and DPU 2000R all have networking capabilities. The DPU has the most limited network capabilities whereas the DPU 2000R has the most expansive of connectivity options and array of protocols. Figure 1-1 shows the general look of the units as viewed from the front.

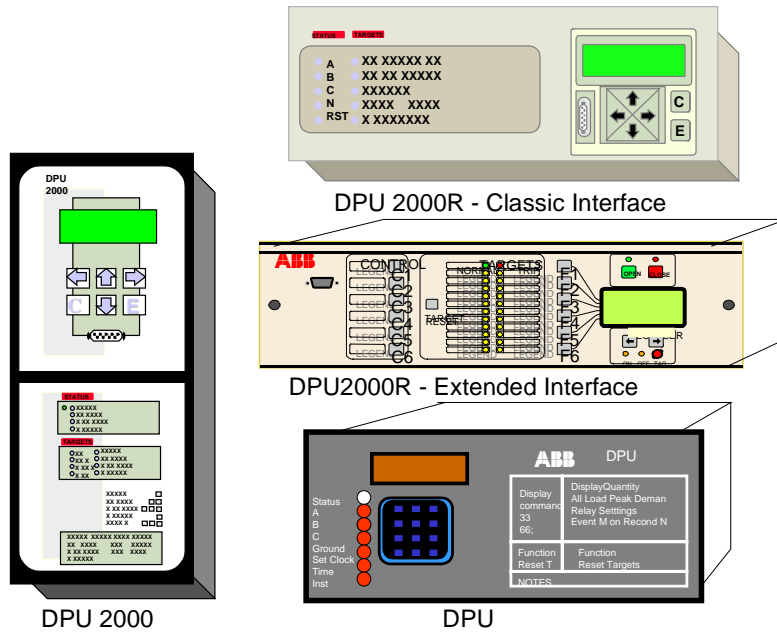

Figure 1-1. Distribution Protection Unit Product Family

The products differentiate themselves as listed in Table 1-1. Table 1-1 lists the available protocols within the relays. Standard Ten Byte is an ABB protocol which is within each of the protective relays. Standard Ten Byte is an asynchronous byte oriented protocol. The programming software (ECP [DOS External Communication Program] and WIN ECP [Windows External Communication Program]) allows configuration of the relay through a port on the units. Standard Ten Byte is available through an RS 232 or RS 485 port on the DPU.

INCOM is an ABB protocol, which is a derivative of Standard Ten Byte. It is a modulated synchronous bit stream using the same commands as in the Standard Ten Byte protocol. INCOM is available on each of the protective relays as indicated within Table 1-1. Its physical interface is proprietary in that the DPU node expects a modulated signal.

Serial Modbus is an industrial de-facto standard protocol, which has been widely embraced by the utility industry. Modbus has two emulation's, RTU, which is a synchronous protocol and ASCII which is an asynchronous protocol. Modbus uses only one command set, but two emulation's. Modbus strengths are that it uses a standard RS 232 or RS 485 interface to interconnect nodes on a network.

Network Modbus is an evolution of Serial Modbus in that it uses Ethernet as the mechanism to transfer the Modbus Serial packets across an Ethernet LAN. It is gaining in popularity in that several protocols and network transmissions may peaceably coexist on a single network cable. Network Modbus (or TCP/IP Modbus) has its own protocol conventions and is not merely initiation of an Ethernet TELNET session over the Local Area Network (LAN).

Modbus Plus is a hybrid protocol refinement of Modbus. Modbus Plus has a proprietary physical interface which is available to device manufacturers through a connectivity program with Groupe Schneider. The interface offers greater speed and communication features than Modbus.

DNP 3.0 is a protocol, which has its roots deep in the utility industry. It is an asynchronous protocol that allows connectivity through a standard RS 232 or RS 485 port. It includes such defined capabilities as file transfer, and timestamping as part of the protocol, which makes it desirable for a utility implementation. UCA is a newly emerging protocol based upon an object oriented device structure. UCA stand for Utility Communication Architecture. Instead of the traditional mindset of data access using address, index terminology, data is retrieved or modified by using predefined "names" to access or modify data. The hardware topology employed for this new protocol is Ethernet (just as that for Network Modbus), however the messaging structure and data access definitions are markedly different. Later sections shall explore the UCA construction from a hardware topology and a software access/control standpoint.

Table 1-1. Protocol Capabilities Listed by Product Type

Product	Protocol	Notes
DPU	TEXT ASCII COMMAND SCRIPT	Not Addressable RS 232 Only
DPU 2000	Standard Ten Byte	Addressable Front Com, Com 1 and Aux Com
	INCOM	2 Wire (AND SHIELD) Current Injection Physical Interface
	Modbus	RS 232 or RS 485
	DNP 3.0	RS 232 or RS 485
DPU 2000R	Standard Ten Byte	RS 232 or RS 485
	INCOM	2 Wire (AND SHIELD) Current Injection Physical Interface
	Serial Modbus	RS 232 or RS 485
	Modbus Plus	Proprietary Current Injection Physical Interface
	Network Modbus	Ethernet Interface Copper or Fiber Optic
	DNP 3.0	RS 232 or RS 485
	UCA	Ethernet Interface Copper or Fiber Optic

Within this document, only **UCA** protocol shall be covered in depth. Modbus Plus, Modbus (Serial and Network Protocols) Standard 10 Byte, INCOM and DNP 3.0 shall be explained superficially. If one would need to reference the specific details of Standard Ten Byte or INCOM protocols, please reference the engineering specifications concerning these topics in Appendix A of this document.

Section 2 – Communication Card Identification and Physical Port Characteristics

The communication connector at the front of the unit (near the target LED's) communicates to the WIN ECP configuration program. This communication port is referred to as COM 0 in DPU 2000R. The protocol emulated through this front port is an addressable emulation of STANDARD 10 BYTE PROTOCOL. With the addition of a communication card option, the unit emulates the protocols described in Table 1-1. The inclusion of optional communication boards enables the rear ports (as shown in Figure 2-2) of their respective units. ONLY THE DPU 2000R SUPPORTS THE UCA COMMUNICATIONS BOARD.

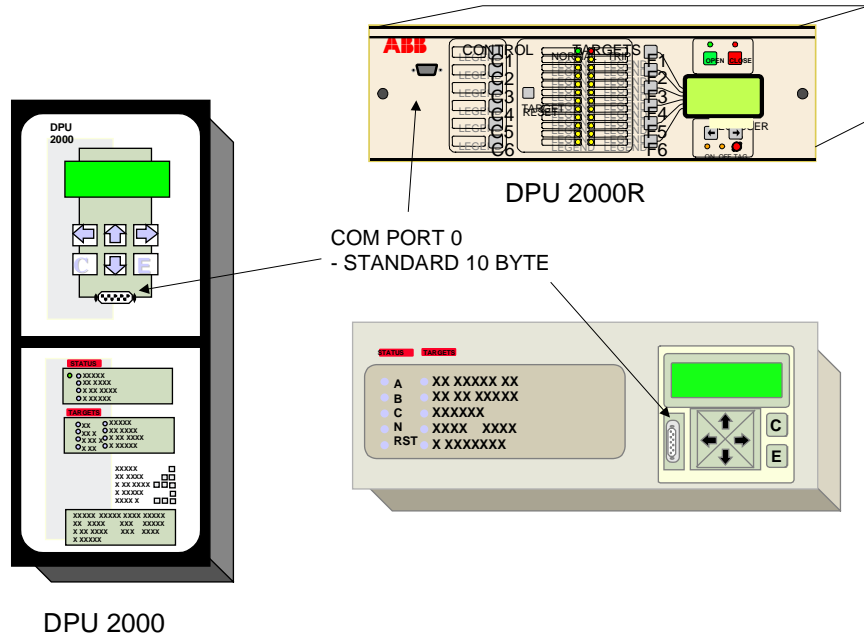

Figure 2-1. COM 0 Port Location

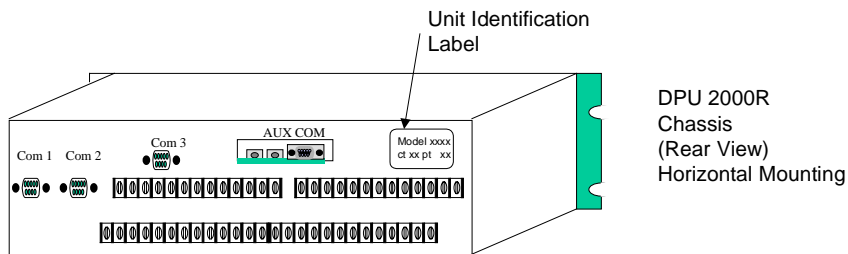
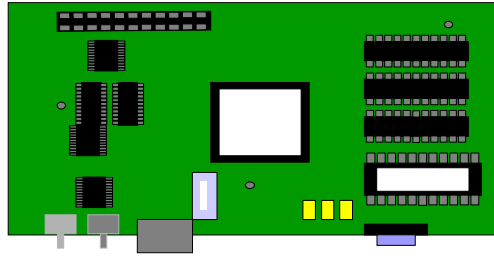

Figure 2-2. Physical Optional Communication Card Port Locations



DPU 2000 R COMMUNICATION CARD (TYPICAL)

Figure 2-3. DPU 2000R Communication Cards

The DPU 2000R mates with the unit's main board to enable/disable Com Ports 1, 2, 3, and AUX COM. The communication cards physical interfaces protrude through the sheet metal back plate housing of the unit and allow for access to the physical connection ports. Figure 2-4 illustrates the location of the communication board assembly.

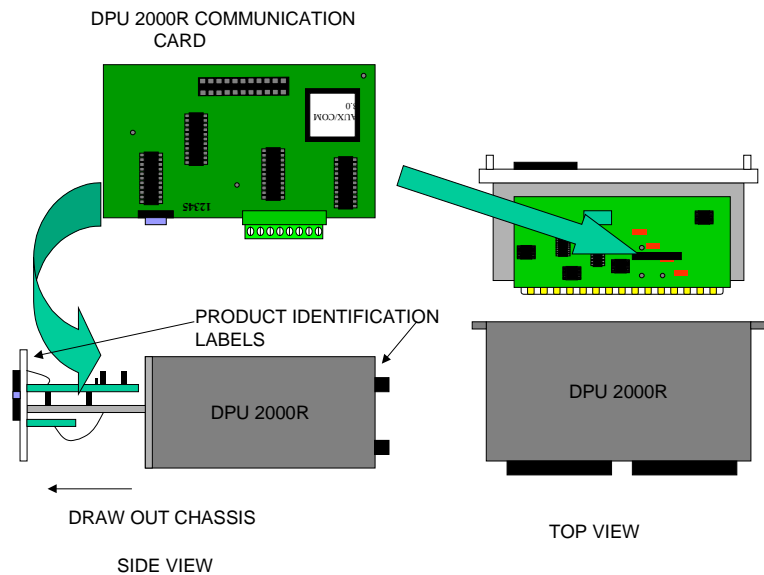

Figure 2-4. Physical Communication Card Location for the DPU 2000R

CAUTION: REMOVAL OF THE DRAW OUT CHASSIS COMPONENTS WILL DE-ENERGIZE THE ELECTRONICS OF THE UNIT THEREBY PREVENTING SYSTEM PROTECTION. EXTREME CARE MUST BE TAKEN WHEN REMOVING THE ELECTRONIC DRAWER FROM THE CHASSIS SINCE ALL PROTECTIVE RELAY FUNCTIONALITY WILL BE TERMINATED.

CAUTION: IF THE UNIT IS UNDER POWER- THE CT's ARE SHORTED INTERNALLY THROUGH THE CHASSIS INTERNAL CONNECTORS. HOWEVER, EXTREME CAUTION MUST BE EXERCISED WHEN REMOVING THE DRAW OUT CASE FROM AN ENERGIZED UNIT. ABB TAKES NO RESPONSIBILITY FOR ACTIONS RESULTING FROM AVOIDANCE OF THIS WARNING AND CAUTION NOTICE.

CAUTION: Sensitive electronic components are contained within the DPU 2000 and DPU 2000R units. The individual removing the component boards from the fixed chassis must be grounded to the same potential as the unit. IF THE OPERATOR AND THE CASE ARE NOT CONNECTED TO THE SAME GROUND POTENTIAL, STATIC ELECTRICITY MAY BE CONDUCTED FROM THE OPERATOR TO THE INTERNAL COMPONENTS RESULTING IN DAMAGE TO THE UNIT.

Communication Card Part Number Options

The DPU 2000R may be ordered with a variety of communication options as listed in Table 2-1. The communication option card installed in the unit is identified by the part number located on the unit or identified through the WIN ECP or Front Panel (LCD) interfaces.

The protocols available are:

- ❑ **STANDARD TEN BYTE** – This is an ABB specific ASCII encoded (asynchronous) 10 byte communication protocol. It allows attainment of all relay parameters. It is the base unit protocol in which configuration programs such as ECP, and WIN ECP communicate to the DPU 2000 or DPU 2000R. It is the protocol standard for the COM 0 communication port of the DPU 2000 and DPU 2000R. STANDARD 10 BYTE does not utilize a proprietary hardware physical interface. APPENDIX A includes the DPU 2000 and DPU 2000R STANDARD 10 BYTE Protocol Document.
- ❑ **INCOM** – This is an ABB Specific bit oriented (synchronous) protocol. INCOM uses the same commands as STANDARD TEN BYTE, but its inherent bandwidth utilization is far greater than STANDARD TEN BYTE is in that no data encoding is required. INCOM only defined two baud rates 9600 and 1200. INCOM is a proprietary interface in that its physical presentation to the communication medium is dependent upon the baud rate selected. 1200 Baud uses current injection baseband signal presentation, whereas 9600-Baud implements a phase shift frequency in its representation of digital 1 and 0 values. Appendix A includes the DPU 2000 and DPU 2000R STANDARD TEN BYTE Protocol document which describes INCOM in further detail.
- ❑ **SPACOM** – This is an ABB Specific byte oriented (asynchronous) protocol common in Europe. It is a Master-Slave protocol which is implemented on a variety of physical interfaces. SPACOM protocol is not covered within this document.
- ❑ **DNP 3.0** - This is a Utility industry standard protocol allowing communication between a host and slave devices. DNP 3.0 is a byte oriented (asynchronous) protocol which is physical interface device independent. The protocol allows for time synchronization, and unsolicited event reporting. It is a very popular protocol in utility installations.
- ❑ **SERIAL MODBUS**- This protocol is an industrial standard. The protocol allows a single master device to communicate with several slave devices. It has gained wide acceptance in that a great majority of utility devices incorporate Modbus protocol. Modbus Protocol is physical interface independent. Modbus Protocol has two emulation's RTU (a synchronous bit oriented emulation) and ASCII (an asynchronous byte oriented emulation). The DPU 2000 and DPU 2000R may be configured for both emulations.
- ❑ **MODBUS PLUS** – This protocol is also an industrial standard. Modbus Plus allows up to 64 devices to communicate among each using token passing techniques. The Modbus Plus protocol is fast (1 megabaud) and uses several advanced techniques to maximize bandwidth. The physical interface to Modbus Plus is proprietary and regulated by Groupe Schneider. Modbus Plus is the incorporation of Modbus commands on a HDLC- like protocol using a current injection interface.
- ❑ **NETWORK MODBUS** – This protocol is derived from the Modbus protocol and is an extension of the protocol on an Ethernet MMS Transport Layer. It is also gaining wide acceptance since it is used frequently with Programmable Logic controllers found commonly in Industrial and Utility applications.
- ❑ **PG&E** – This protocol is a bit oriented asynchronous protocol allowing a Master Device to communicate with several slave devices. PG&E protocol is a Utility protocol. The protocol is not described in this document.
- ❑ **UCA** – This evolving protocol is based upon an Ethernet standard in which each of the elements within the protocol are object oriented. This next step in network protocol architecture allows the device to be self reporting with regard to the protocol objects defined in the device. This automation manual covers all aspects of the ABB DPU 2000R's implementation of the protocol.

The device configuration for the DPU 2000R is illustrated in Tables 2-1 and 2-2 illustrating the configuration options. The generic part number for the DPU 2000 is 587 X X X Y Z – X X X X Q. Deciphering the part numbers: found on the labels of the unit or obtained through ECP or the FRONT PANEL LCD INTERFACE, allows easy identification of the communication options found on the unit.

Table 2-1. DPU 2000R Communication Options

IF PART NUMBER POSITION “Y” IS	THE DPU 2000R HAS AN INSTALLED OPTION For unit 587 X X X Y Z – X X X X Q (X = Don’t Care) (FRONT PANEL INTERFACE OPTION)
0	Horizontal Unit Mounting – NO FRONT PANEL LCD INTERFACE
1	Horizontal Unit Mounting – FRONT PANEL LCD INTERFACE IS INCLUDED
2	Horizontal Enhanced OCI – FRONT PANEL LCD AND PUSHBUTTON INTERFACE INCLUDED
3	Horizontal Enhanced OCI – FRONT PANEL LCD AND PUSHBUTTON INTERFACE INCLUDED with Hot Line Tagging.
5	Vertical Unit Mounting – NO FRONT PANEL LCD INTERFACE
6	Vertical Unit Mounting – FRONT PANEL LCD INTERFACE IS INCLUDED
7	Vertical Enhanced OCI – FRONT PANEL LCD AND PUSHBUTTON INTERFACE INCLUDED
8	Vertical Enhanced OCI – FRONT PANEL LCD AND PUSHBUTTON INTERFACE INCLUDED with Hot Line Tagging.
IF PART NUMBER POSITION “Z” IS	THE DPU 2000R HAS AN INSTALLED OPTION For unit 587 X X X Y Z – X X X X Q (X = Don’t Care) (COMMUNICATION PHYSICAL INTERFACE OPTION)
0	RS 232 (COM 1) Non-isolated Port is active on the unit
1	RS 232 (COM 2) Isolated Port Only is active on the unit (SEE NOTE)
2	RS 485 (AUX COM PORT) and RS 232 (COM 3) Ports on Option Card.
3	INCOM (AUX COM PORT) and RS 485 (AUX COM PORT) Ports on Option Card
4	INCOM (AUX COM PORT) and RS 485 (AUX COM PORT) Ports on Option Card
5	RS 485 (AUX COM PORT) Port On Option Card
6	Modbus Plus Port (COM 3) on the Option Card
7	Modbus Plus (COM 3) and RS 485 (AUX COM PORT) on the Option Card
8	RS 485 (COM 3) and RS 485 (AUX COM PORT) Ports on the Option Card
E	Ethernet Fiber Optic and Copper Option Card
	NOTE: * = If the option denoted in part number position “Y” is a 0 or 5, the COM 2 port is enabled, If the option denoted in part number position “Y” is a 1 or 5 the COM 2 Port is enabled.
IF PART NUMBER POSITION “Q” IS	THE DPU 2000R HAS AN INSTALLED OPTION For unit 587 X X X Y Z – X X X X Q (X = Don’t Care) (COMMUNICATION PHYSICAL INTERFACE OPTION)
0	STANDARD TEN BYTE
1	DNP 3.0
2	SPACOM
3	PG&E
4	SERIAL MODBUS /NETWORK MODBUS PLUS/MODBUS PLUS (Depending on hardware interface selected in Position Z)
6	UCA
7	NETWORK MODBUS AND UCA

Table 2-2. DPU 2000R Communication Card Matrix for Unit 587 X X X Y Z – X X X X Q

“Z” Digit	“Q” Digit	COM 1 RS 232	COM 2 RS 232	COM 3	AUX COM	INCOM	IRIG B
0	0	Note 1	Standard 10 Byte				
1	0	Note 1		Standard 10 Byte RS 232			
2	0	Note 1		Standard 10 Byte RS 232	Standard 10 Byte RS 485		AVAILABLE
2	1	Note 1		Standard 10 Byte or DNP 3.0 RS 232	Standard 10 Byte or DNP 3.0 RS 485		
2	2	Note 1		Standard 10 Byte RS 232	SPACOM RS 485		
2	4	Note 1		Standard 10 Byte or Modbus RS 232	Standard 10 Byte or Modbus RS 485		AVAILABLE
3	0	Note 1				AVAILABLE	AVAILABLE
4	0	Note 1			Standard 10 Byte RS 484	AVAILABLE	AVAILABLE
4	1	Note 1			DNP 3.0 RS 485	AVAILABLE	AVAILABLE
4	2	Note 1			SPACOM RS 485		
4	4	Note 1			Modbus RS 485	AVAILABLE	AVAILABLE
5	0	Note 1			Standard 10 Byte RS 485		
6	4	Note 1	Standard 10 Byte	Modbus Plus			
7	4	Note 1		Modbus Plus	Standard 10 Byte RS 485		
8	0	Note 1		Standard 10 Byte RS 485	Standard 10 Byte RS 485		AVAILABLE
8	1	Note 1		Standard 10 Byte or DNP 3.0 RS 485	Standard 10 Byte or DNP 3.0 RS 485		
8	4	Note 1		Standard 10 Byte or Modbus RS 485	Standard 10 Byte or Modbus RS 485		AVAILABLE
E	4	Note 1			Network Modbus Ethernet Copper or Ethernet Fiber Optic		
E	6	Note 1			UCA Ethernet Copper or Ethernet Fiber Optic		
E	7	Note 1			UCA or Network Modbus Ethernet Copper or Ethernet Fiber Optic Note 2		

NOTE 1: Enabled Standard 10 Byte if Digit “Y” is 0 or 5. Front Panel Interface not included Unavailable if Digit “Y” is 1, 2, 3, 4, 6, 7, or 8.

NOTE 2: Only one port Copper or Fiber Optic is enabled, both protocols co-exist on the same medium.

The visual identification of a DPU 2000R communication card is completed through visual inspection of the card component location and of the part number of the base printed circuit board as illustrated in Table 2-3.

Table 2-3. DPU 2000R Communication Card Matrix

“Z” Digit	Raw Circuit Board Part Number	Components To Look For
1	COMM 485 PCB 613709-005 REV0	Parts near black 9 pin 232 connector are populated
2	2000R AUX COM 613708-005 REV0	Parts in middle of board are not populated –2 DC/DC Converters (U1 & U8)
3	AUX COM 613708-005 REV0	Only parts in middle of board – no DC/DC Converters, has Transformer T2
4	AUX COM 613708-005 REV0	Parts near black 9 pin 232 connector are not populated – only 1 DC/DC Converter (U1)
5	COMM 485 PCB 613709-005 REV0	Parts near green connector are populated
6	MODBUS COMM PCB 613720-002 REV1	RS-485 option parts NOT populated (area inside dotted border)
7	MODBUS COMM PCB 613720-002 REV1	Fully populated
8	AUX & AUX 613755-002 REV0	Fully populated
E	TO BE DETERMINED	-----

Unit Communication Card Verification

There are several ways to identify the communication cards inserted in the DPU 2000R units. Some of the methods require the unit to be powered up. Other methods require the unit to be taken out of service.

To identify the unit part number of the present DPU 2000R, the following steps may be executed to facilitate unit identification.

1. With the unit energized:
 - If the unit has a Front Panel LCD (Refer to Tables 2-1 through 2-3 inclusive for identification) Interface
 1. Depress the “E” Key.
 2. Depress the Arrow Down Key “↓” once to highlight the SETTINGS field. Depress the “E” Key.
 3. Depress the Arrow Down Key “↓” twice to highlight the UNIT INFORMATION field. Depress the “E” key.
 4. The Serial Number and Catalog Number shall be displayed. Fill in Table 2-1 with the required data.
 - If the Unit does not have a Front Panel LCD Interface (Refer to Tables 2-1 through 2-3 inclusive for identification) and the user has DOS ECP or if the user wishes not to use the unit’s Front Panel LCD Interface.
 1. Start ECP.
 2. Select the appropriate communication parameters so that the personal computer attached to the DPU 2000 or DPU 2000(R) will communicate via the null modem cable connection. (See Figures 3-3 and 3-4, pages 16 and 17).
 3. Depress enter to allow attachment of the unit.
 4. The Serial Number and Catalog Number shall be displayed.
 - If the unit has an Enhanced Front Panel Interface (Refer to Tables 2-1 through 2-3 inclusive for identification) and the user wishes to obtain the information via the front panel interface, the following procedure must be followed to identify the board type present in the protective relay.
 1. From the metering screen displayed on the front panel interface, depress F1.

2. From the displayed submenu, depress the selection associated with F2- MAIN MENU.
 3. The selection of submenus will be displayed, depress the key F6 associated with the submenu, PAGE DOWN.
 4. Depress the key F4 to display the submenu selection UNIT INFO.
 5. This selection shall display the part number, serial number of the unit and the associated software versions for the CPU, DSP (Digital Signal Processor) and the Communication firmware present in the unit.
- If the Unit does not have a Front Panel LCD (Refer to Tables 2-1 through 2-3 inclusive for identification) Interface and the user has WINECP or if the user wishes not to use the unit's Front Panel Interface.
1. Connect WIN ECP to the COM 0 port and attach the unit using the correct cable which varies whether the unit is a "CLASSIC " or Enhanced Front Panel Interface Version.
 2. Start WIN ECP.
 3. Depress the "DIRECT ACCESS" selection button presented in the pop-up window.
 4. Depress the "CONNECT" option selection presented within the pop-up window.
 5. Select the "HELP" menu option at the top right-hand section of the menu bar.
 6. Select the Drag-Down menu item "UNIT INFORMATION".
 7. A pop-up window shall appear with the Serial Number and Catalog Number.
2. At the back of the DPU 2000R chassis, in the left-hand lower section of the unit, a label shall appear indicating the serial number and model number of the unit. It should match the data presented in the, WIN ECP or Front Panel Interface (FPI) menus. If it does not, please contact the factory.
 3. As a final check, if the DPU 2000R can be powered-down or if protection can be interrupted, loosen the front panel screws at the front of the unit. Remove the product component drawer from the chassis. Face the front panel interface, and rotate the board so that the semiconductor components are directly visible. On the backside of the metal panel supporting the Front Panel Interface, a label shall be available indicating the serial number and model number. These numbers should match those obtained in steps 1 and 2. If they do not, please contact the factory.

Section 3 - DPU 2000R Device Connectivity for Configuration and UCA Ethernet Ports

Communication between devices is only possible through connectivity of the units through a physical media interface. There are three physical interface types on a DPU 2000R when a UCA Ethernet card is inserted in the device. Those physical interfaces are:

- ❑ RS 232 (isolated and non-isolated)
- ❑ Ethernet – 10 Base T interface
- ❑ Ethernet – 10 Base FL interface

Table 3-1 lists the characteristics for each of the port types.

Table 3-1. Physical Interface Options

	DPU 2000R	Notes
COM 0	RS 232 NON ISOLATED	Front Port Standard 10 Byte
COM 1	RS 232 NON ISOLATED	Standard 10 Byte Only (Not used for UCA Card)
COM 2	RS 232 NON ISOLATED	Standard 10 Byte Only (Not used for UCA Card)
COM 3	RS 232 Isolated/RS 485 Isolated or Modbus Plus	NONE – INTERNAL DIAGNOSTIC PORT ON UCA CARD
AUX COM	10 Base FL Port and Ethernet Copper Connection	Only one port is operational depending upon the slide switch position on the card.

RS 232 Interface Connectivity

RS 232 is perhaps the most utilized and least understood communication interface in use. RS 232 is sometimes misinterpreted to be a protocol; it is in fact a physical interface. A physical interface is the hardware and network physical media used to propagate a signal between devices. Examples of physical interfaces are RS 232 serial link, printer parallel port, current loop, V. 24, IEEE Bus... Examples of network media are, twisted copper pair, coaxial cable, free air...

RS 232 gained widespread acceptance due to its ability to connect to another RS 232 device or modem. A modem is a device, which takes a communication signal and modulates it into another form. Common forms of modems include telephone, fiber optic, microwave, and radio frequency. Modem connectivity allows attachment of multiple devices on a communication network or allows extension of communication distances in a network with two nodes. Physical connection of two devices or more than two devices require differing approaches. Figure 3-1 illustrates a topology using two devices (point to point topology). Figure 3-2 illustrates a multi-drop topology between many nodes. RS 232 was designed to allow two devices to communicate without using intermediate devices.

Port Isolation

Network installation within a substation requires special considerations. A substation environment is harsh in that high levels of electromagnetic interference are present. Additional ground currents are present in such installations. RS 232 is an unbalanced network in that all signals are referenced to a common ground. On longer cable runs, the potential of the signals at the sending device can be significantly lower than at the receiving end due to electrical interference and induced ground current. This increases with long runs of cable and use of unshielded cable. ABB's Substation Automation and Protection recommends the length of RS 232 cable be less than 10 feet (3 meters) for an un-isolated port and that the cable be shielded. Internal to a typical device, the RS 232 transceivers are referenced to the electronic components internal ground. Any electrical interference could be coupled through the chip set and fed back to the device. Typical isolation ratings of a non-isolated port could be as low as 1 volt. Such a port could allow electrical feedback of noise to the electronics for any signal interference over 1 volt.

Coms 0 through 2 on DPU/TPU/GPU units are non – isolated. However an RS 232 implementation on Com 3 uses opto-isolation technology which increases electrical isolation from the port to the devices internal circuitry to 2.3 kV. It is highly desirable to utilize this port in connection to devices in longer cable runs and dedicated communication networks. RS 232 isolated ports are limited in connection distance for a maximum of fifty feet.

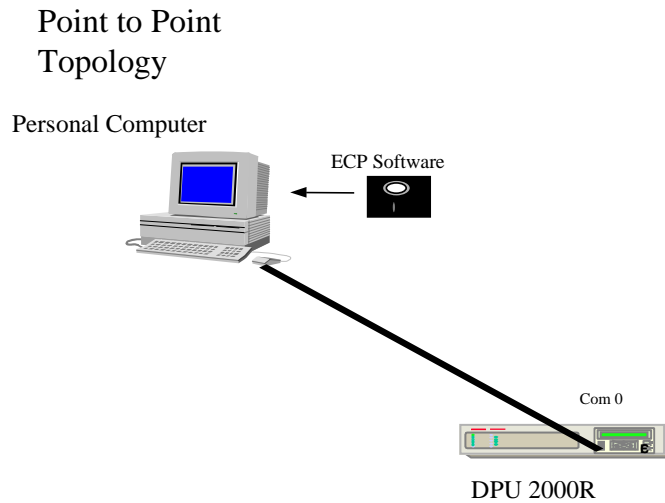

Figure 3-1. Point to Point Architecture Using RS 232

RS 232 Handshaking Defined

Handshaking is the ability of the device to control the flow of data between devices. There are two types of “handshaking”, hardware and software. Hardware handshaking involves the manipulation of the RTS (Request to Send) and CTS (Clear to Send) card control signal lines allowing data communication direction and data flow rates to be controlled by the DTE device. Also the flow is controlled by the DTR (Data Terminal Ready) signal which allows the DCE operation.

Software handshaking involves the data flow control by sending specific characters in the data streams. To enable transmission, the XON character is transmitted. To disable reception of data, the transmitting device sends an XOFF character. If the XOFF character is imbedded within the data stream as information, the receiving node automatically turns off. This is the main weakness of software handshaking, inadvertent operation due to control characters being imbedded within data streams. Software handshaking is usually used in printer control.

The DPU/TPU/GPU devices do not incorporate handshaking, therefore, the control lines may be ignored as illustrated in Figure 3-1. However, some PC software utilizes handshaking, thus the port on the personal computer may require a special hardware configuration of the cable to the port. Consult with the software vendor to determine RS 232 control and buffering requirements and the need for signal jumpers required in RS 232 cabling.

The ports on the DPU/TPU/GPU have been tested for operation up to a speed of 19,200 baud. 19,200 baud is the typical data rate applicable for the operation of an asynchronous communication connection over RS 232 without the use of additional timing lines.

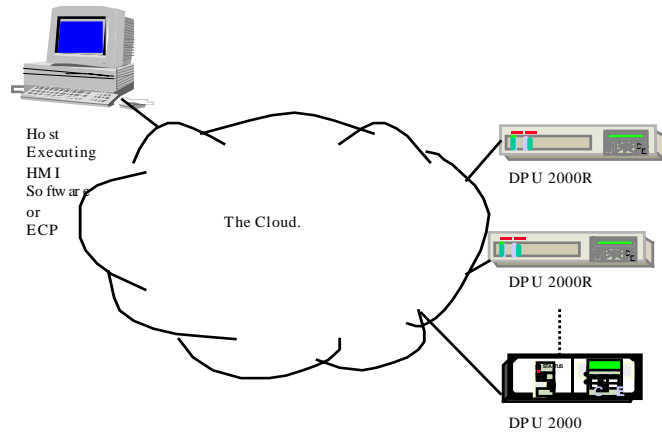
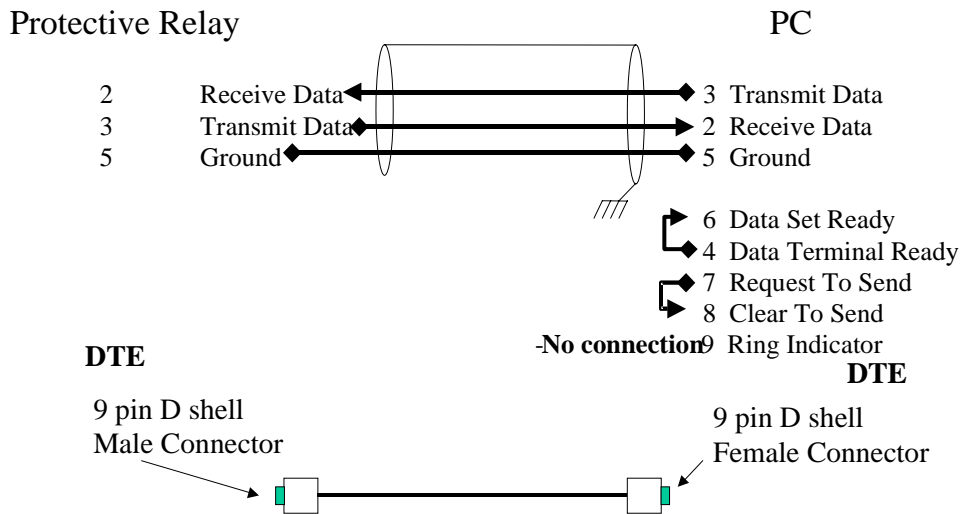

Figure 3-2. Multi-Drop Topology Using RS 232

RS 232 Cable Connectivity

A cable diagram is illustrated in Figure 3-3 and 3-4. Figure 3-3 shows the direction of communication signal transmission and the gender of the connectors used in constructing a communication cable. IT IS IMPORTANT TO REALIZE THAT THE ENHANCED PANEL OCI COM 0 INTERFACE OFFERS A DCE CONNECTION WHEREAS THE TRADITIONAL FRONT PANEL INTERFACE OFFERS A DTE CONNECTION. IT IS ALSO IMPORTANT TO REALIZE THAT BOTH MODELS OFFER COM.



CLASSIC INTERFACE DPU 2000R CABLE
to PC Cable 9 to 9 Pin-out

Figure 3-3. Classic DPU 2000R DB9 RS 232 Cable Diagram

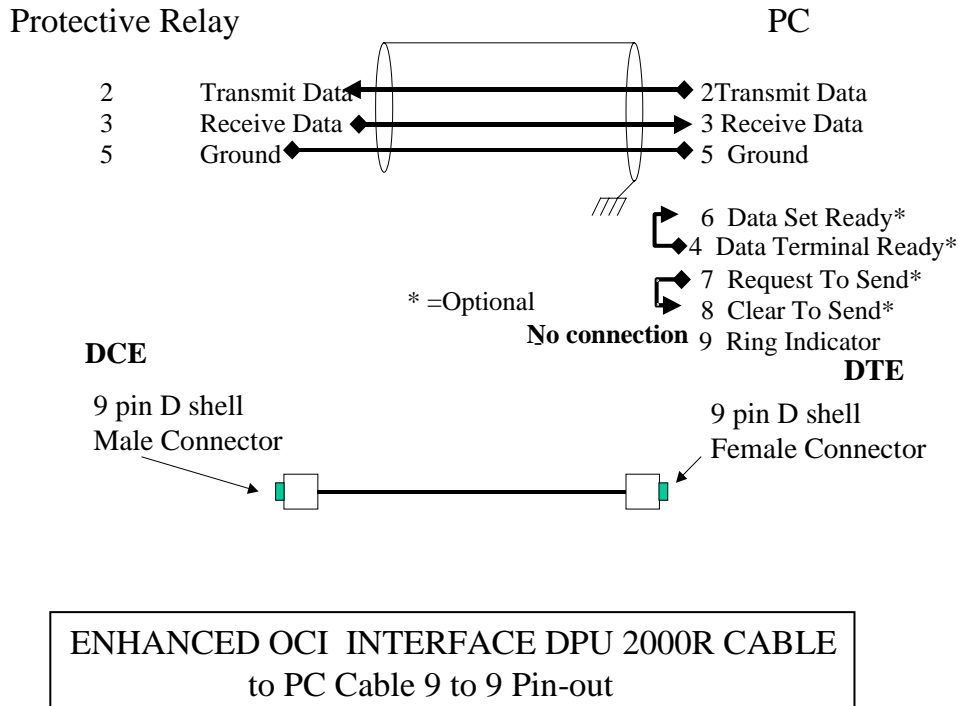

Figure 3-4. Enhanced OCI DPU 2000R DB 9 RS 232 Cable Diagram

An RS 232 interface was designed to simplify the interconnection of devices. Definition of terms may demystify issues concerning RS 232 interconnection. Two types of RS 232 devices are available, DTE and DCE. DTE stands for **Data Terminal Equipment** whereas DCE stands for **Data Communication Equipment**. These definitions categorize whether the device originates/receives the data (DTE) or electrically modifies and transfers data from location to location (DCE). Personal Computers are generally DTE devices while line drivers/modems/converters are DCE devices. DPU/TPU/GPU devices have RS 232 DTE implementation. Generally, with a few exceptions, a "straight through cable" (a cable with each pin being passed through the cable without jumpering or modification) will allow a DTE device to communicate to a DCE device.

Connection of a PC to a DPU2000 or DPU 2000R requires cable modification since the interconnected devices are both DTE. The same cabling would be utilized if one would connect two DCE devices. The classifications of DTE/DCE devices allow the implementers to determine which device generates the signal and which device receives the signal. Studying Figure 3-4, Pins 2 and 3 are data signals, pin 5 is ground whereas pins 1, 6, 7, 8, 9 are control signals. The arrows illustrate signal direction in a DTE device. The DPU 2000 and DPU 2000R series of protective devices do not incorporate hardware or software "handshaking".

If a host device has an RS 232 physical interface with a DB 25 connector, reference Figure 3-5 for the correct wiring interconnection.

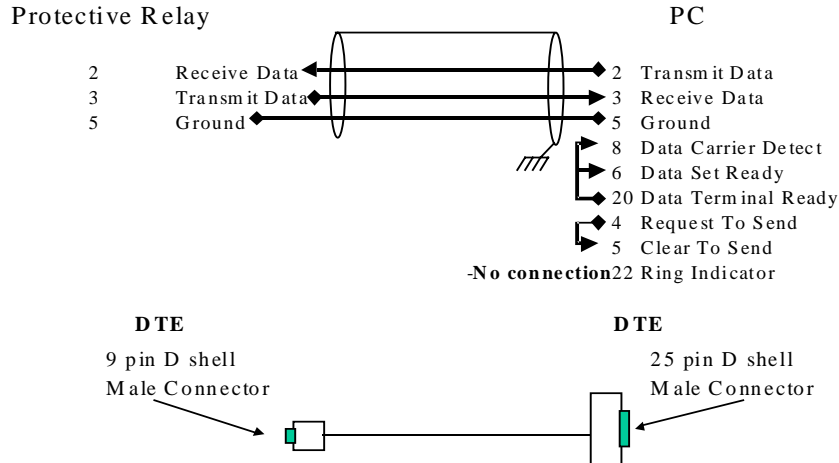

Figure 3-5. Connection of a DB 25 Connector to a DPU 2000 or DPU 2000R Classic Interface

It must be noted that the RS 232 port resident on the COM 3 interface port is not operational. It is used only for internal diagnostics and factory testing. Only COM 0 (Front Panel Interface Port) is operational when the UCA card is inserted in the device.

Ethernet Connectivity

There are two interfaces on the Ethernet UCA card when it is inserted in the unit. The two interfaces are available on the device are a 10 BASE T copper interface and a 10 BASE FL fiber optic interface. As illustrated in Figure 3-6 a slide switch is available to enable one of the two interfaces on the card. Slide the switch towards the card edge connectors to enable the FIBER OPTIC interface, slide the switch away from the card edge connector to enable the COPPER interface.

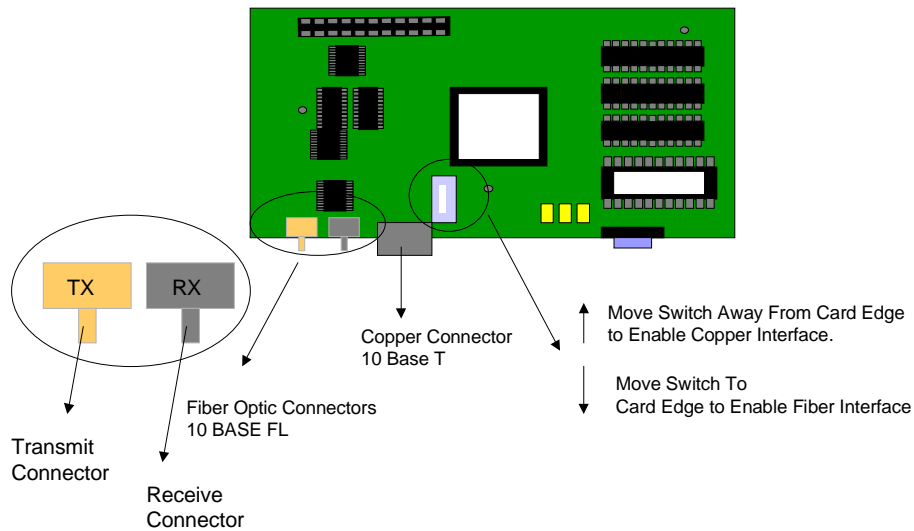

Figure 3-6. Connection Diagram for Copper/Fiber Interfaces

Ethernet connectivity is based upon a star topology connection. The Ethernet card operates with an Ethernet Hub or Switch to effectuate operation. The topology diagrams are illustrated in Figure 3-7 of this document illustrating the topology of the device.

If an Ethernet switch is used, reference the manufacturer's documentation for setup of the device.

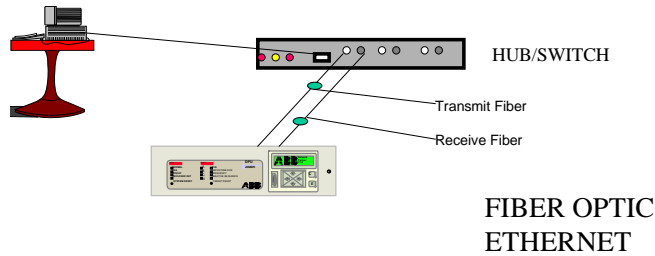
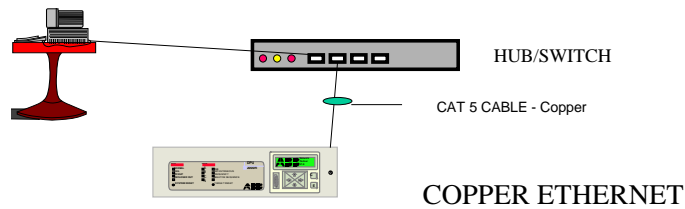

Figure 3-7. Typical Hub/Switch Connection Using Fiber or Copper Ethernet

Fiber Optic Specifications

THE COPPER PORT IS NOT ISOLATED. IT IS ONLY RECOMMENDED THAT THIS PORT BE USED FOR LABORATORY USES AND IN CASES WHERE ISOLATION OF THE RELAY IS NOT AN ISSUE.

The recommended cable type is an 890 nanometer (nm)/62.5 micrometer (μM) multimode cable with an ST connector on the DPU 2000R Ethernet card connector end must be used for the application. The other end must have an end connector corresponding to the connector style used on the hub/switch module.

The chipset used in the Fiber Optic section of the Ethernet card uses an Agilent HFBR-1414T for Transmission and an Agilent HFBR2416 for reception of the message.

Copper Ethernet Specifications

Copper Twisted Pair can be used to interconnect the DPU 2000R with the hub or switch. The cable must be a CAT-5 Cable with an RJ45 cable. The cable is commonly referred to as a "STRAIGHT THROUGH CABLE". DO NOT USE A "CROSS PINNED" CAT 5 copper cable.

Section 4 - DPU 2000R Device Parameterization

Establishing DPU 2000R communication depends upon correct parameterization of the communication menus within the unit. Parameterization may occur via the unit's front panel interface or through ECP (External Communication Program) or WIN ECP (WINDOWS External Communication Program). Modbus, Modbus Plus and DNP require certain parameterizations. Even COM 0 requires certain parameterization to communication with the configuration program.

COM 0 Port (Front Port Configuration)

In order to attach a configuration program to the DPU 2000R, the correct parameters must be set up within the unit. The supported parameters are listed in Table 4-1 below. The protocol for the unit is addressable Standard 10 Byte. To view the communication port parameters it is advised that they should be viewed via the unit's front panel interface. If the DPU 2000R does not have a front panel interface, the parameters should be marked on the front panel sticker with the port's parameters.

The keystrokes required for visualizing the communication port parameters from the metering display are:

1. Depress the "E" pushbutton.
2. Depress the "↓" key once to select the SETTINGS menu and then depress the "E" pushbutton.
3. Depress the "E" pushbutton to select the SHOW SETTINGS menu selection.
4. Depress the "↓" key six times to select the COMMUNICATIONS menu and then depress the "E" pushbutton.
5. Under the SHOW COM SETTINGS MENU, the following shall be displayed for the Front Panel RS 232 port (FP).
 - Unit Node Address (Address displayed in HEX)
 - FP RS 232 Baud
 - FP RS 232 Frame

Other parameters shall be shown. The parameters listed shall vary in accordance with the communication card inserted within the unit. However, the FP displayed parameters must match with the parameters configured in the Standard Ten Byte section of the ECP package.

One may change parameters via the front panel interface. The selections for each parameter required in Front Panel Port configuration is shown in Table 4-1.

Table 4-1. DPU 2000R Com Port 0 Front Panel Interface Parameters

Option	Selection	Notes
Unit Node Address	1 to FFF (1 = default setting)	1 to 2048 decimal node address
FP RS 232 Baud	300	Selectable Baud Rates for the Standard Ten Byte Front Panel Port.
	1200	
	2400	
	4800	
	9600 (default setting)	
FP RS 232 Frame	N – 8 – 1 (default setting)	No Parity 8 Data Bits 1 Stop Bit
	N – 8 – 2	No Parity 8 Data Bits 2 Stop Bits

Modification of the Front Panel Parameters for a CLASSIC DPU 2000R, change of the settings is accomplished via the following keystrokes:

1. From the metering menu depress the "E" key.
2. Depress the "↓" key once to select the SETTINGS menu and then depress the "E" pushbutton.
3. Depress the "↓" key once to select the SHOW SETTINGS menu selection. Depress the "E" pushbutton.
4. Depress the "↓" key seven times to select the COMMUNICATIONS menu and then depress the "E" pushbutton.
5. Enter the unit's password, one digit at a time. The default password is four spaces. Depress the "E" pushbutton once.

6. The CHANGE COMMUNICATION SETTINGS menu shall be displayed. With the cursor at the Unit Address field, depress "E". The unit address can be modified. The address selected in this field will configure the address for the entire node. Use the "↓" and "↑" arrow keys to select the password digit entry. Use the "→" and "←" keys to select the digit to configure. Depress "E" to save the digits. Depress "C" to return to the root menu.
7. Once returned to the main menu, depress the "↓" key once to select the FRONT RS 232 BAUD RATE menu and then depress the "E" pushbutton. The selections for the menu are listed in Table 4-1. Use the "→" and "←" keys to select the baud rates for the port. Depress "E" to select the entry. Depress "C" to return to the root menu.
8. Once returned to the main menu, depress the "↓" key once to select the FRONT RS 232 FRAME menu and then depress the "E" pushbutton. The selections for the menu are listed in Table 4-1. Use the "→" and "←" keys to select the baud rates for the port. Depress "E" to select the entry. Depress "C" to return to the root menu.
9. To Save the selections configured in the previous steps depress the "C" pushbutton. A query will be presented to the operator "Enter YES to save settings <NO>". Use the "→" and "←" keys to select the option YES and depress "E" to save the settings.

If one has an Enhanced Operator Interface on a DPU 2000R, the following procedure allows for the modification and the viewing of the COM 0 port parameters.

1. Depress F1 <MENU>
2. Depress F2 <MAIN MENU>
3. Depress F3 <SHOW SETTINGS MENU>
4. Depress F6 <PAGE DOWN>
5. Depress F4 <COMMUNICATION MENU>
6. The selections for UNIT ADDRESS, and FP RS 232 Baud, as well as FP RS 232 Framing is visible.

To change the settings for the front panel port, follow the following keystroke sequence for the Enhanced Version of the DPU 2000R.

1. Depress F1 <MENU>
2. Depress F2 <MAIN MENU>
3. Depress F4 <CHANGE SETTINGS MENU>
4. Depress F6 <PAGE DOWN>
5. Depress F5 <COMMUNICATION MENU>
6. Enter the PASSWORD using the F2, F3, and F4 keys . The default password is four spaces.
7. Depress F6 to enter the password. If it is accepted, one shall be able to change the following parameters:
 - F2 UNIT ADDRESS
 - F3 FP RS 232 BAUD
 - F4 FR RS 232 FRAME
8. Once the appropriate parameters have been entered for the DPU 2000R, then depress F6 END OF COMM to enter the screen to save the parameters.
9. Depress F1 <ESC>. One shall be prompted for SAVE SETTINGS? Depressing F4 – YES, F5 NO.

If the unit does not have a front panel interface, it is advisable that the communication port parameters be marked on the front of the unit. If the parameters are not known, please contact ABB Technical Support to obtain the procedure to determine the parameters or take the unit out of service and reset the port parameters.

Figure 4-1 illustrates the parameterization screen in WIN ECP which must be parameterized allowing communication between the configuration unit and the DPU 2000R. The WIN ECP VERSION for parameterization of the UCA board must be version 4.3 or greater.

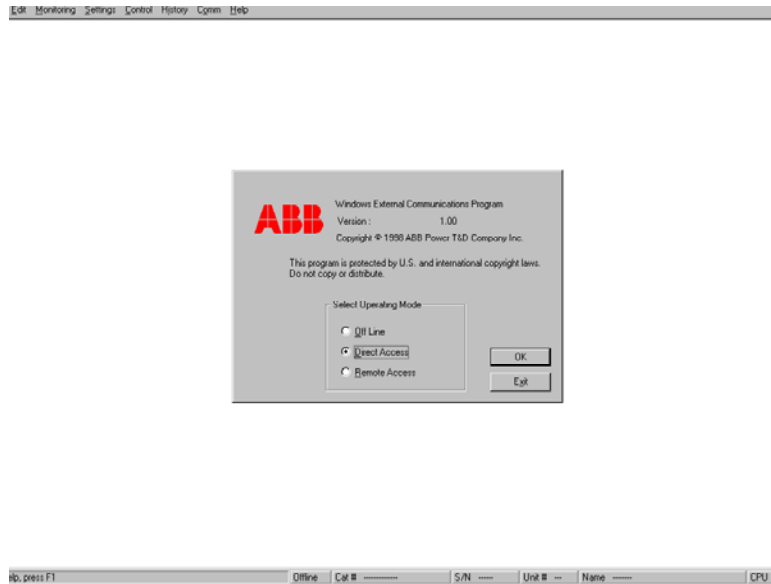

Figure 4-1. Initial WIN ECP Communication Configuration Screen

A direct connect is selected in this instance allowing retrieval and configuration of the relay parameters. Once the OK button is depressed, the screen shown in Figure 4-2 is presented to the operator.

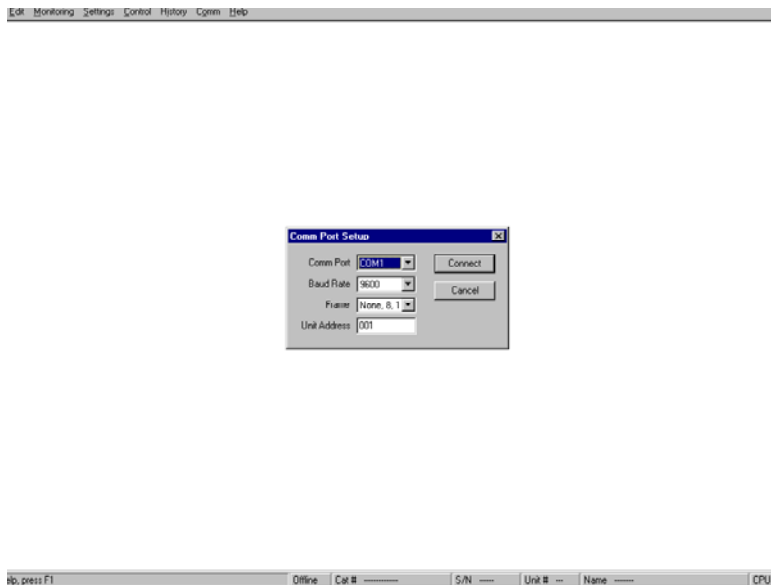

Figure 4-2. Communication Port Setup Screen

The selections in WIN ECP are illustrated in Table 4-2. The settings must agree with those configured in the DPU 2000 and DPU 2000R.

Table 4-2. WIN ECP Communication Port Settings

Option	Selection	Notes
COM PORT	COM 1	Personal Computer Port Selection for ECP to DPU 2000R connection.
	COM 2	
	COM 3	
	COM 4	
BAUD RATE	300	Baud Rates Offered for DPU 2000R connection to the WIN ECP RS 232 port connection
	1200	
	2400	
	4800	
	9600 (default setting)	
	19200	
Frame	None – 8 – 1 (default setting)	No Parity 8 Data Bits 1 Stop Bit
	None– 8 – 2	No Parity 8 Data Bits 2 Stop Bits
	Even – 8 – 1	Even Parity 8 Data Bits 1 Stop Bit
	Odd – 8 - 1	Odd Parity 8 Data Bits 1 Stop Bit
	Even – 7- 1	Even Parity 7 Data Bits 1 Stop Bit
	None – 7 – 2	Even Parity 7 Data Bits 2 Stop Bits
	Odd – 7 - 1	Odd Parity 7 Data Bits 1 Stop Bit
Unit Address	1 – FFF (1 = Default)	Unit Address in HEX
NOTE : Bold indicates Selections Supported by WIN ECP AND DPU 2000 / DPU 2000R		

COM Port 1 Option Settings (DPU 2000R ONLY) [Catalog 587 XXX00-XXX0 or 587 XXX50-XXX0]

If the unit does not have a front panel interface, the rear port is on the DPU 2000R is active. The Configuration screens through WIN ECP are shown in Figure 4-3 for reference. The communication options may not be configured via the front panel interface since this port is only active if the unit does not have a front panel communication port interface (see Section 3 of this document for further information). The communication protocol supported on this port is Standard Ten Byte Only.

Table 4-3 illustrates the port configuration options available for this COM PORT 1. Figure 4-3 illustrates the WIN ECP screen used to configure Communication Port 1 in the DPU 2000R.

Table 4-3. COM Port 1 and COM Port 2 WIN ECP Port Settings

Option	Selection	Notes
BAUD RATE	300	Com Port Baud Rate Selections Via WIN ECP
	1200	
	2400	
	4800	
	9600 (default setting)	
	19200	
	38400	
Frame	None – 8 – 1 (default setting)	No Parity 8 Data Bits 1 Stop Bit
	None– 8 – 2	No Parity 8 Data Bits 2 Stop Bits
	Even – 8 – 1	Even Parity 8 Data Bits 1 Stop Bit
	Odd – 8 - 1	Odd Parity 8 Data Bits 1 Stop Bit
	Even – 7- 1	Even Parity 7 Data Bits 1 Stop Bit
	None – 7 – 2	Even Parity 7 Data Bits 2 Stop Bits
	Odd – 7 - 1	Odd Parity 7 Data Bits 1 Stop Bit

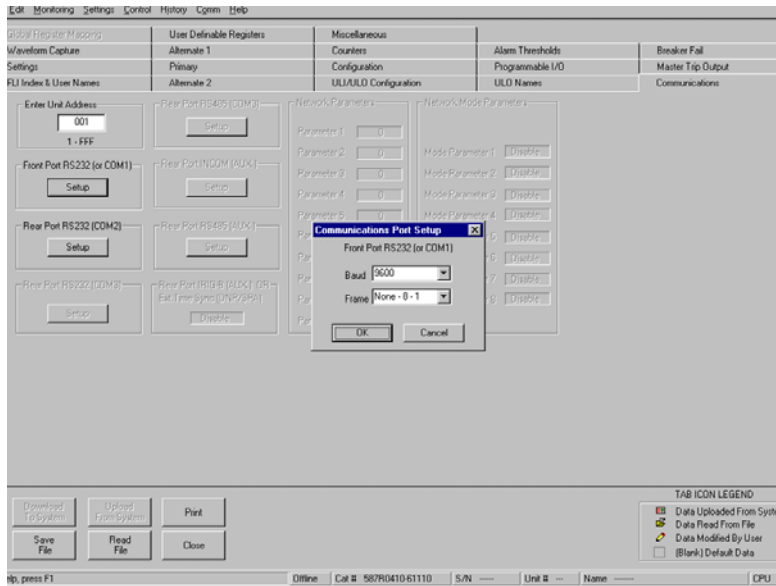

Figure 4-3. COM PORT 1 WIN ECP Setting Screen

Ethernet Protocol Parameter Visualization and Parameterization Procedure (DPU2000R Only)

The TCP/IP Modbus Ethernet Communication Port Settings can only be viewed from the FRONT PANEL INTERFACE. Version 4.3 of the WIN ECP program is the only method to change the UCA Ethernet Card settings. However, one can view the UCA Ethernet Card settings by executing the following procedure, if an “enhanced” front panel interface unit parameters are viewed:

1. Depress F1 <MENU>
2. Depress F2 <MAIN MENU>
3. Depress F3 <SHOW SETTINGS MENU>
4. Depress F6 <PAGE DOWN>
5. Depress F4 <COMMUNICATION MENU>
6. The selections resident in this Submenu selection are:
 - Unit Address
 - FP RS 232 BAUD
 - FP RS 232 FRAME
 - MAC ADDRESS HI
 - MAC ADDRESS MID
 - MAC ADDRESS LO
 - TCP/IP/0
 - TCP/IP/1
 - TCP/IP/2
 - TCP/IP/3
 - NSAP 1 H
 - NSAP 1 L
 - NSAP 2 H
 - NSAP 2 L
 - TP ACK H
 - TP ACK L
 - TP InACT H
 - TP InACT L

To Parameterize the UCA CARD, one can only change the settings by using the WIN ECP program version 4.3 or greater. The procedure to access the settings is as follows:

1. Start WIN ECP Ver 4.3 from the Windows operating system icon.
2. The screen as illustrated in Figure 4-4 shall be visible. Select Direct Access for the DPU 2000R attached.

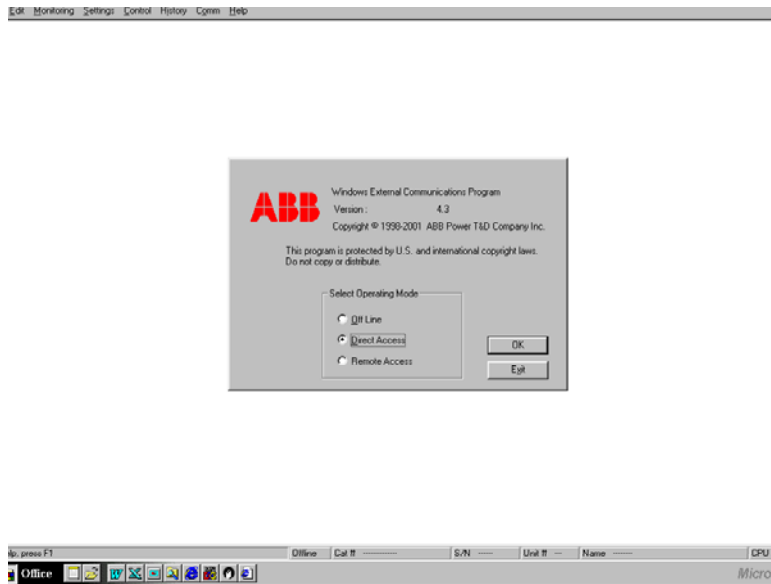

Figure 4-4. WIN ECP Start Up Screen for Direct Access Attachment

3. Select the “OK” Button Selection. Enter the proper COM 0 Port Parameters as illustrated in Section 4 of this document.
4. From the WINDOWS MENU selection bar, select the Settings menu revealing the Settings Submenu. Within the viewable screen area, a dialog box shall be visible as illustrated in Figure 4-5.
5. Depress the Select ALL Button to select all settings to be uploaded from the DPU 2000R. As illustrated in Figure 4-5, a separate tab is available for the UCA COMMUNICATIONS option resident in the DPU 2000R.

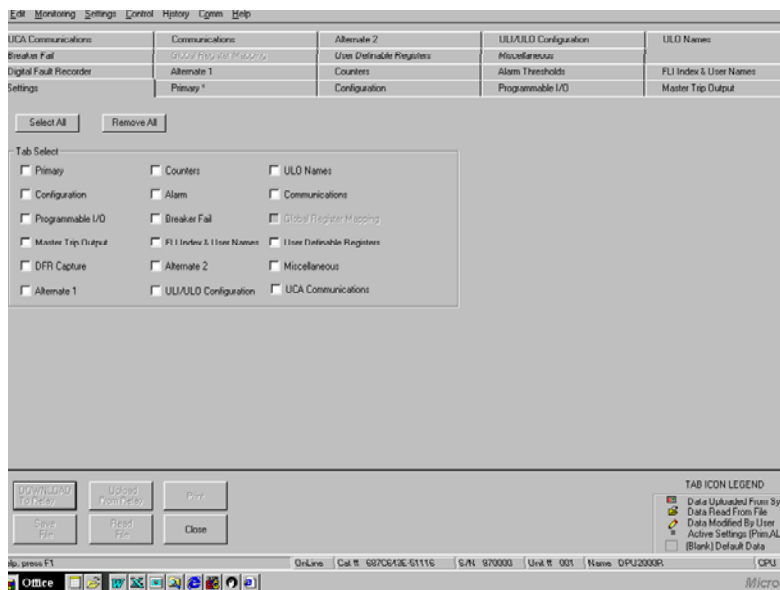

Figure 4-5. Windows Settings Screen for Upload/Download of Settings

6. Depress the UPLOAD FROM RELAY pushbutton. All settings shall be uploaded from the DPU 2000R. A “FLAG” icon shall be visible on each of the tabs on the screen to indicate that the settings on the screen area

match those in the relay. A windows dialog box will indicate that the “UPLOAD FROM RELAY IS SUCCESSFUL”. When the dialog box appears, depress OK to confirm.

7. Depress the UCA COMMUNICATIONS tab to reveal the configuration screen for the UCA CARD. The screen is illustrated in Figure 4-6.

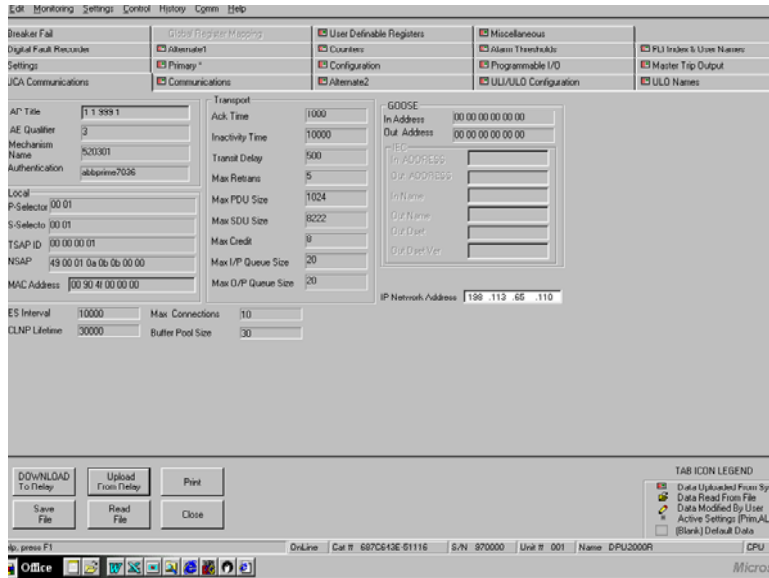

Figure 4-6. UCA Card Communication Parameter Screen

8. If one places the Windows cursor over the parameters boxes and mouse clicks over that area, an additional dialog box shall be visible to change the parameter.
9. Once parameters have been modified, Depress the “DOWNLOAD TO RELAY” pushbutton to send the new UCA CARD parameters to the relay.

IT IS IMPORTANT TO NOTE THAT WHEN UCA CARD PARAMETERS ARE CHANGED, THE CARD REBOOTS ITSELF AND IS UNABLE TO COMMUNICATE ON THE ETHERNET NETWORK FOR A SHORT PERIOD OF TIME (2 MINUTES).

Although only the IP (Internet Protocol Address) is the only protocol parameter to be configured, other parameters are available (but grey-ed out) for configuration.

The following screens illustrate the parameters available for configuration:

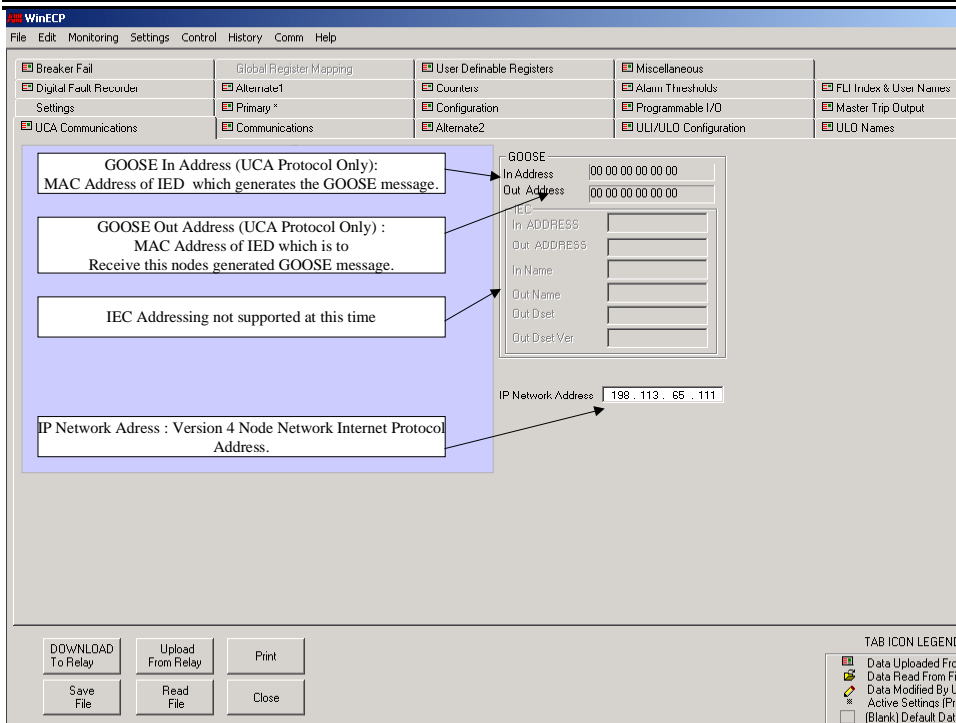

FIGURE 4-A Configuration Parameters for the Modbus Ethernet Type “E” card.

Since the Type “E” Ethernet board is a foundation platform for the Ethernet Modbus, and UCA protocol offerings, the configuration screen contains elements common to both protocols. Some of the fields are not valid for Modbus TCP/IP configuration.

The following Figures 4-B through 4-E explain the parameters available for “fine tuning” the Ethernet Port Interface. It is not recommended to modify the parameters listed, however the figures are given for reference only.

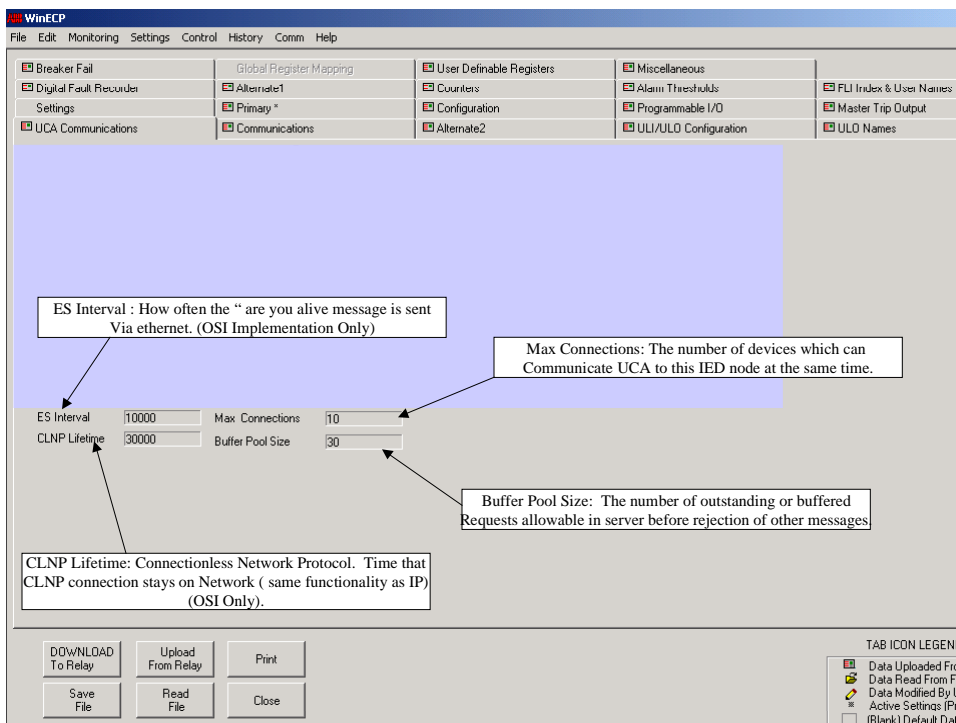

FIGURE 4-B : Modbus TCP/IP Ethernet Port Parameter Defintions.

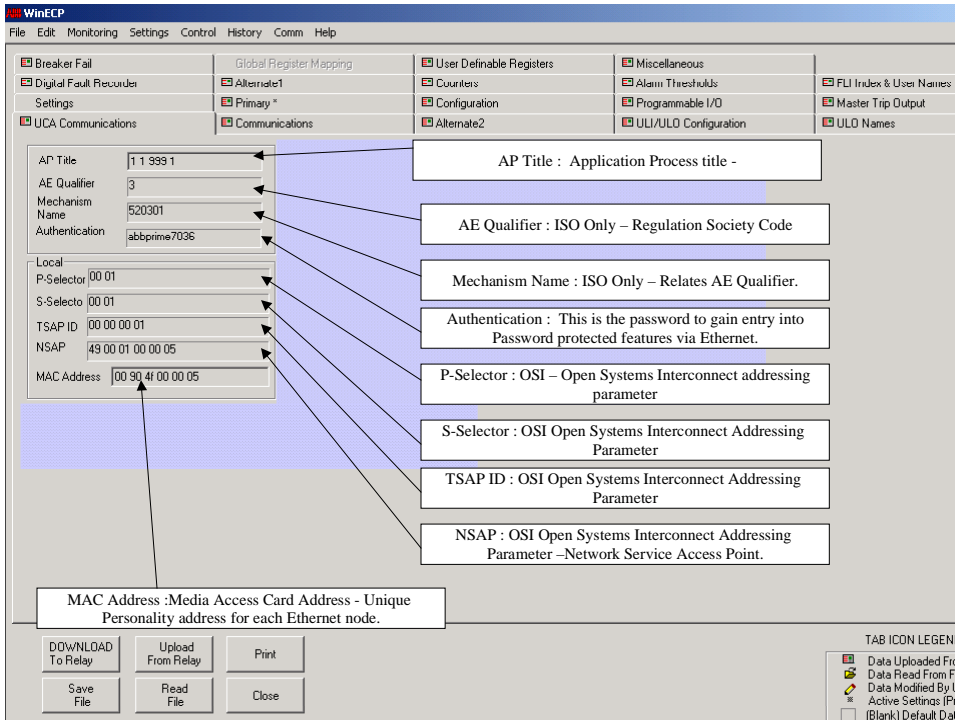

FIGURE 4-C: Modbus TCP/IP Ethernet Port Parameter Definitions.

Figure 4-C has one parameter which should be modified “Authentication”. The Modbus TCP/IP board has the capability to become a FTP client. The client capability allows upload of Fault, Operation and Comtrade Oscillographic files from the DPU 2000R. To allow access of the DPU 2000R from a browser, one must provide a password for authentication. The desired password is configured in the “Authentication” entry window as illustrated in Figure 4-C.

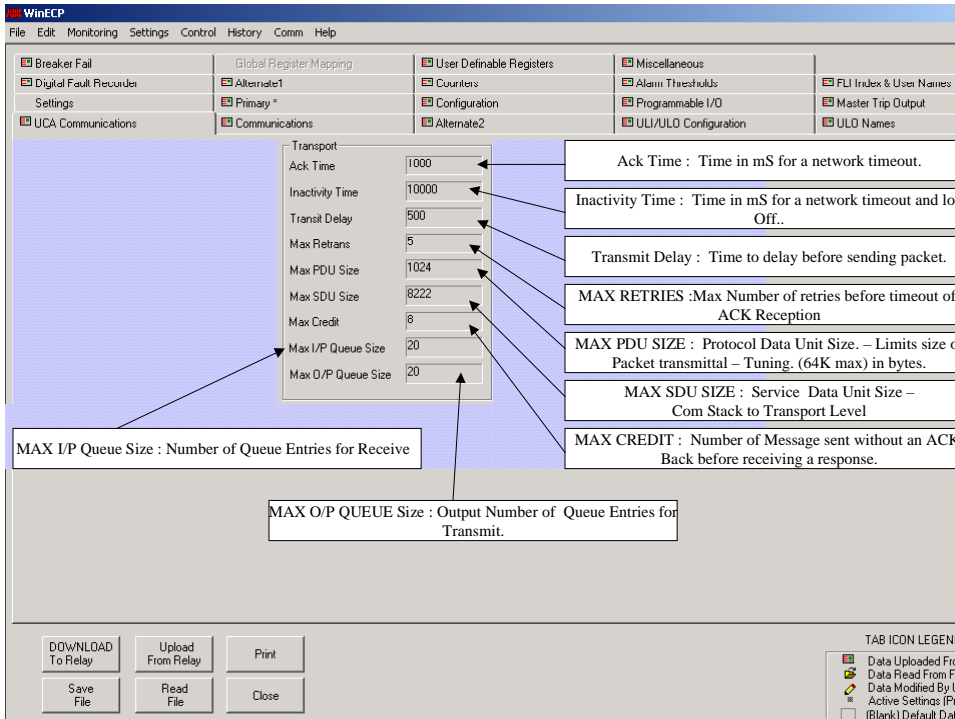

FIGURE 4-D: Modbus TCP/IP Ethernet Port Configuration Screen

Verification of Communication

Once cable connection, and device parameterization has been accomplished, a simple method to determine that communications is occurring between a host and the IED is to perform a single communications to the relay.

What follows is the procedure to confirm that all steps have been executed correctly.

1. From within WINDOWS, bring up the DOS WINDOW.
2. Type from the DOS command line:
Ping 198.113.65.110
3. Depress the Enter key on the keyboard. One should see the returned response that communications has occurred.

Section 5 - UCA Object Description

UCA (UTILITY COMMUNICATION ARCHITECTURE), is an Ethernet based object oriented protocol. The philosophy of the UCA, is that each manufacturer of device “models” each internal IED information type to a pre-defined object type. To simplify the discussion, one could think of an IED, traditionally with information scattered within the relay. This is illustrated in Figure 5-1. Within a relay, Fault Records, Identity Information, Diagnostics, Metering Information is resident.

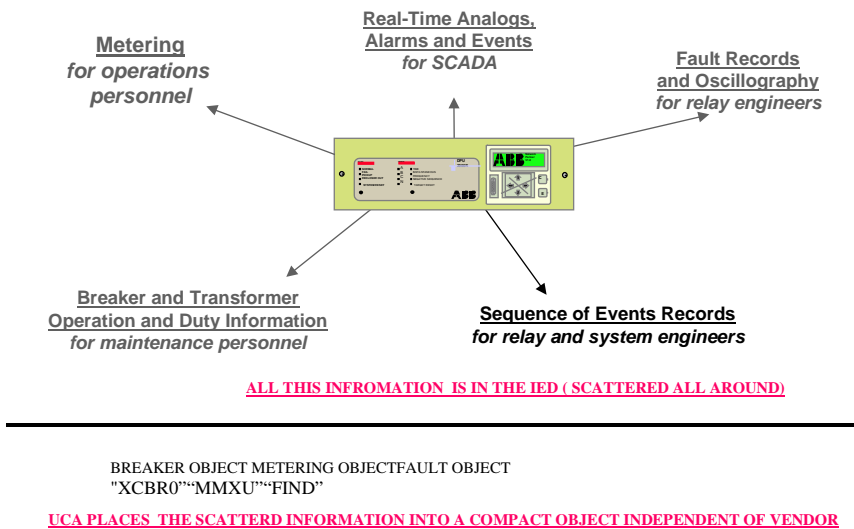

Figure 5-1. UCA Object Model Implementation in an IED

Within the definition of the UCA protocol, several “OBJECTS” have been defined which identify various capabilities in the relay, for example MMXU (Metering Information), or FIND (FAULT INDICATION).

UCA is a self-identifying protocol in that when the relay is first queried, each “object” contained within the IED is reported to the server requesting the information. Each “object” contains a variety of additional information. This information is referred to as a “Brick”. If one was to express this as an all encompassing picture, one could then express it as in Figure 5-2.

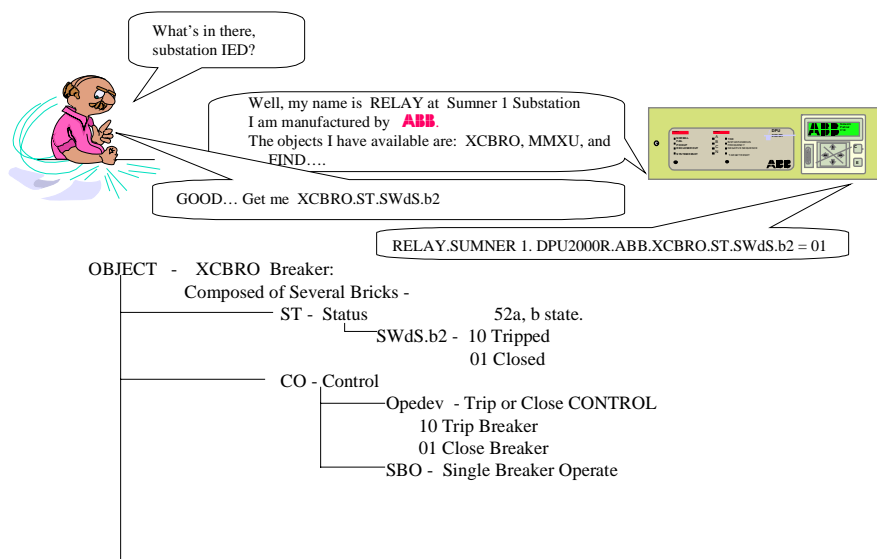

Figure 5-2. UCA Object Philosophy

Numerous volumes have been written describing the construction of UCA Objects. Section 5 of this Automation Document lists the capabilities of the UCA card within the DPU 2000R with respect to object implementation. For further information, please reference the UCA Documentation titled “Utility Communication Architecture 2.0, Generic Object Models for Substation & Feeder Equipment (GOMSFE) Version 0.92”

Please reference this document for the complete explanation of UCA. What follows is a listing of the UCA objects contained in Version 1.0 of the UCA Ethernet implementation for the DPU 2000R.

Objects Modelled in the DPU 2000R

Three “feature groups” are implemented in the DPU 2000R UCA card, These groups are: Monitoring, Control and Post Fault. Within the Monitoring and Control “Feature Groups”, UCA objects are modeled within the device. However within the Post Fault “Feature Group”, objects are modeled as well as Ethernet features such as File Transfer. Within the explanation of the Post Fault Data which can be obtained from the relay, the concepts of Client and Server are explained as well as the concept of obtaining COMTRADE FILES, FAULT RECORDS, and OPERATION RECORDS in a file format.

Monitoring Objects

Within the DPU 2000R are elements which are customarily monitored such as: metering data access, device identity. What follows is a listing of the UCA Monitoring Objects available:

- DEVICE IDENTITY (DI)
- GLOBAL VALUES (GLOBE)
- METERING
- METERING – MMXU (POLYPHASE MEASUREMENT UNIT)
- METERING – MMTR (POLYPHASE METER UNIT)
- METERING – MSQI (SEQUENCE AND IMBALANCE METERING)
- METERING – MDMD (DEMAND METERING)
- STATUS
- STATUS – INSTANTANEOUS OVERCURRENT ELEMENT OBJECT - PBRO
- STATUS – GROUND TIME OVERCURRENT ELEMENT OBJECT - PBRO
- STATUS – DIRECTIONAL OVERCURRENT ELEMENT OBJECT - PBRO
- STATUS – PHASE BALANCE CURRENT ELEMENT OBJECT - PBRO
- STATUS – DIRECTIONAL POWER RELAY ELEMENT OBJECT - PBRO
- STATUS – UNDER VOLTAGE ELEMENT OBJECT - PBRO

STATUS – OVERVOLTAGE ELEMENT OBJECT - PBRO

The list of the UCA OBJECTS supported in the DPU 2000R as defined in the UCA 0.92 specification follows:

Device Identity (DI)

Every device has a unique identity that describes the device, its nameplate data, location, and other data that seldom changes.

Table 5-1. Device Identity Object Model Definition

Logical Device/Object Name	Data Type	o/m	Supported	Description String or Comment
DI\$Class	VSTR32	o	no	
DI\$CommID\$CommAdr	VSTR16	m	yes	
DI\$CommID\$CommRev	VSTR8	o	yes	
DI\$CommID\$Pro	ENUM8	o	yes	1 (MMS)
DI\$CommID\$Med	ENUM8	o	no	
DI\$CommID\$MAC	INT8U	o	yes	
DI\$d	VSTR64	o	no	"DPU 2000R"
DI\$Loc	VSTR128	o	no	
DI\$Name	VSTR32	m	yes	Get device name from Config values
DI\$Own	VSTR32	o	no	
DI\$VndID\$DevMdl	VSTR128	o	yes	"DPU 2000R"
DI\$VndID\$HwRev	VSTR8	o	yes	
DI\$VndID\$Mdl	VSTR32	o	yes	
DI\$VndID\$SerNum	VSTR32	m	yes	"(catalog number) serial number"
DI\$VndID\$SftRev	VSTR8	o	yes	
DI\$VndID\$Vnd	VSTR32	m	yes	"ABB"

Global Values (GLOBE)

GLOBE is a logical device level block that is used to model attributes that are global to the Logical Device.

Table 5-2. Global Variable Object Model Definition

Logical Device/Object Name	Data Type	o/m	Supported	Description String or Comment
GLOBE\$CF\$ClockTOD	BTIME6	o	yes	
GLOBE\$CF\$Img	VSTR128	o	no	
GLOBE\$CF\$NeutRef	BOOL	o	no	
GLOBE\$CF\$SelInDNA	DNA	o	no	
GLOBE\$CF\$SelOutDNA	DNA	o	no	
GLOBE\$CO\$ActSG	INT8U	o	no	

GLOBE\$CO\$AuxOut<n>	BOOL16	o	no	
GLOBE\$CO\$CopySG	INT8U	o	no	
GLOBE\$CO\$IndRs	BOOL	o	yes	Resets Indicators, Targets & LEDs
GLOBE\$CO\$SaveSG	INT8U	o	no	
GLOBE\$DC\$ModeDS\$d	VSTR64	o	yes	"Device Status"
GLOBE\$DC\$LocRemDS\$d	VSTR64	o	yes	"Control Mode"
GLOBE\$RP\$brcbMX		o	no	
GLOBE\$RP\$brcbST		o	no	
GLOBE\$RP\$GOOSE		o	no	
GLOBE\$SP\$DefDNA		o	no	
GLOBE\$SP\$ForDNA		o	no	
GLOBE\$SP\$PreSetDna		o	no	
GLOBE\$ST\$ActSG	INT8U	o	no	
GLOBE\$ST\$AuxIn<n>	BOOL<n>	o	no	
GLOBE\$ST\$EditSG	INT8U	o	no	
GLOBE\$ST\$ModeDS\$b2	BSTR2	m	yes	Device is: off-line/avail/unhealthy
GLOBE\$ST\$ModeDS\$q	BSTR16	m	yes	
GLOBE\$ST\$ModeDS\$t	BTIME6	m	yes	
GLOBE\$ST\$LocRemDS\$b2	BSTR2	m	yes	Mode of Control: local/remote
GLOBE\$ST\$LocRemDS\$q	BSTR16	m	yes	
GLOBE\$ST\$LocRemDS\$t	BTIME6	m	yes	
GLOBE\$DC\$FaultDS\$d	VSTR64	o	yes	"New Fault Indication"
GLOBE\$DC\$OperDS\$d	VSTR64	o	yes	"New Operation Indication"
GLOBE\$DC\$OscDS\$d	VSTR64	o	yes	"New Oscillography Indication"
GLOBE\$ST\$FaultDS\$b2	BSTR2	o	yes	Fault Indication: new/no new
GLOBE\$ST\$FaultDS\$q	BSTR16	o	yes	
GLOBE\$ST\$FaultDS\$t	BTIME6	o	yes	
GLOBE\$ST\$OperDS\$b2	BSTR2	o	yes	Operations Indication: new/no new
GLOBE\$ST\$OperDS\$q	BSTR16	o	yes	
GLOBE\$ST\$OperDS\$t	BTIME6	o	yes	
GLOBE\$ST\$OscDS\$b2	BSTR2	o	yes	Oscillography Indication: new/no new
GLOBE\$ST\$OscDS\$q	BSTR16	o	yes	
GLOBE\$ST\$OscDS\$t	BTIME6	o	yes	

Metering – Polyphase Measurement Unit (MMXU)

Polyphase Measurement Unit provides for measurement of single phase or polyphase analog values (including neutral), pertaining to a wye or delta connected field device or circuit.

Table 5-3. Polyphase Measurement Unit Object Model Definition

Logical Device/Object Name	Data Type	o/m	Supported	Description String or Comment
DPU/MMXU0\$CF\$A\$s	INT32U	o	yes	
DPU/MMXU0\$CF\$A\$u	ENUM8	o	yes	5 (ampere)
DPU/MMXU0\$CF\$AvgPF\$s	INT32U	o	yes	
DPU/MMXU0\$CF\$AvgPF\$u	ENUM8	o	yes	1 (dimensionless)
DPU/MMXU0\$CF\$Hz\$s	INT32U	o	yes	
DPU/MMXU0\$CF\$Hz\$u	ENUM8	o	yes	33 (hertz)
DPU/MMXU0\$CF\$PPV\$s	INT32U	o	yes	
DPU/MMXU0\$CF\$PPV\$u	ENUM8	o	yes	29 (volt)
DPU/MMXU0\$CF\$TotVA\$s	INT32U	o	yes	
DPU/MMXU0\$CF\$TotVA\$u	ENUM8	o	yes	61 (volt ampere)
DPU/MMXU0\$CF\$TotVAr\$s	INT32U	o	yes	
DPU/MMXU0\$CF\$TotVAr\$u	ENUM8	o	yes	63 (volt ampere reactive)
DPU/MMXU0\$CF\$TotW\$s	INT32U	o	yes	

DPU 2000R UCA TECHNICAL GUIDE

DPU/MMXU0\$CF\$TotW\$u	ENUM8	o	yes	62 (watts)
DPU/MMXU0\$CF\$V\$s	INT32U	o	yes	
DPU/MMXU0\$CF\$V\$u	ENUM8	o	yes	29 (volt)
DPU/MMXU0\$CF\$VAr\$s	INT32U	o	yes	
DPU/MMXU0\$CF\$VAr\$u	ENUM8	o	yes	63 (volt ampere reactive)
DPU/MMXU0\$CF\$W\$s	INT32U	o	yes	
DPU/MMXU0\$CF\$W\$u	ENUM8	o	yes	62 (watts)
DPU/MMXU0\$DC\$A\$d	VSTR64	o	yes	"Current in Phase A, B, C, N"
DPU/MMXU0\$DC\$AvgPF\$d	VSTR64	o	yes	"Average Power Factor, all 3 phases"
DPU/MMXU0\$DC\$Hz\$d	VSTR64	o	yes	"Frequency"
DPU/MMXU0\$DC\$PPV\$d	VSTR64	o	yes	"Voltage Phase AB, BC, CA"
DPU/MMXU0\$DC\$TotVA\$d	VSTR64	o	yes	"Total VA, all 3 phases"
DPU/MMXU0\$DC\$TotVAr\$d	VSTR64	o	yes	"Total VAr, all 3 phases"
DPU/MMXU0\$DC\$TotW\$d	VSTR64	o	yes	"Total Watts, all 3 phases"
DPU/MMXU0\$DC\$V\$d	VSTR64	o	yes	"Voltage on phase A, B, C to G"
DPU/MMXU0\$DC\$VAr\$d	VSTR64	o	yes	"VAr, in phase A, B, C"
DPU/MMXU0\$DC\$W\$d	VSTR64	o	yes	"Watts in phase A, B, C"
DPU/MMXU0\$MX\$V\$PhsAi	INT16S	o	yes	
DPU/MMXU0\$MX\$V\$PhsAAngi	INT16S	o	yes	
DPU/MMXU0\$MX\$V\$PhsAq	BSTR16	o	yes	
DPU/MMXU0\$MX\$V\$PhsAt	BTIME6	o	yes	
DPU/MMXU0\$MX\$V\$PhsBi	INT16S	o	yes	
DPU/MMXU0\$MX\$V\$PhsBAngi	INT16S	o	yes	
DPU/MMXU0\$MX\$V\$PhsBq	BSTR16	o	yes	
DPU/MMXU0\$MX\$V\$PhsBt	BTIME6	o	yes	
DPU/MMXU0\$MX\$V\$PhsCi	INT16S	o	yes	
DPU/MMXU0\$MX\$V\$PhsCAngi	INT16S	o	yes	
DPU/MMXU0\$MX\$V\$PhsCq	BSTR16	o	yes	
DPU/MMXU0\$MX\$V\$PhsCt	BTIME6	o	yes	
DPU/MMXU0\$MX\$PPV\$PhsABi	INT16S	o	yes	
DPU/MMXU0\$MX\$PPV\$PhsBCi	INT16S	o	yes	
DPU/MMXU0\$MX\$PPV\$PhsCAi	INT16S	o	yes	
DPU/MMXU0\$MX\$PPV\$q	BSTR16	o	yes	
DPU/MMXU0\$MX\$PPV\$t	BTIME6	o	yes	
DPU/MMXU0\$MX\$A\$Neuti	INT16S	o	yes	
DPU/MMXU0\$MX\$A\$PhsNAngi	INT16S	o	yes	
DPU/MMXU0\$MX\$A\$Neutq	BSTR16	o	yes	
DPU/MMXU0\$MX\$A\$Neutt	BTIME6	o	yes	
DPU/MMXU0\$MX\$A\$PhsAi	INT16S	o	yes	
DPU/MMXU0\$MX\$A\$PhsAAngi	INT16S	o	yes	
DPU/MMXU0\$MX\$A\$PhsAq	BSTR16	o	yes	
DPU/MMXU0\$MX\$A\$PhsAt	BTIME6	o	yes	
DPU/MMXU0\$MX\$A\$PhsBi	INT16S	o	yes	
DPU/MMXU0\$MX\$A\$PhsBAngi	INT16S	o	yes	
DPU/MMXU0\$MX\$A\$PhsBq	BSTR16	o	yes	
DPU/MMXU0\$MX\$A\$PhsBt	BTIME6	o	yes	
DPU/MMXU0\$MX\$A\$PhsCi	INT16S	o	yes	
DPU/MMXU0\$MX\$A\$PhsCAngi	INT16S	o	yes	
DPU/MMXU0\$MX\$A\$PhsCq	BSTR16	o	yes	
DPU/MMXU0\$MX\$A\$PhsCt	BTIME6	o	yes	
DPU/MMXU0\$MX\$W\$PhsAi	INT16S	o	yes	
DPU/MMXU0\$MX\$W\$PhsAq	BSTR16	o	yes	
DPU/MMXU0\$MX\$W\$PhsAt	BTIME6	o	yes	
DPU/MMXU0\$MX\$W\$PhsBi	INT16S	o	yes	
DPU/MMXU0\$MX\$W\$PhsBq	BSTR16	o	yes	

DPU/MMXU0\$MX\$W\$PhsBt	BTIME6	o	yes	
DPU/MMXU0\$MX\$W\$PhsCi	INT16S	o	yes	
DPU/MMXU0\$MX\$W\$PhsCq	BSTR16	o	yes	
DPU/MMXU0\$MX\$W\$PhsCt	BTIME6	o	yes	
DPU/MMXU0\$MX\$TotW\$i	INT16S	o	yes	
DPU/MMXU0\$MX\$TotW\$q	BSTR16	o	yes	
DPU/MMXU0\$MX\$TotW\$t	BTIME6	o	yes	
DPU/MMXU0\$MX\$VAr\$PhsAi	INT16S	o	yes	
DPU/MMXU0\$MX\$VAr\$PhsAq	BSTR16	o	yes	
DPU/MMXU0\$MX\$VAr\$PhsAt	BTIME6	o	yes	
DPU/MMXU0\$MX\$VAr\$PhsBi	INT16S	o	yes	
DPU/MMXU0\$MX\$VAr\$PhsBq	BSTR16	o	yes	
DPU/MMXU0\$MX\$VAr\$PhsBt	BTIME6	o	yes	
DPU/MMXU0\$MX\$VAr\$PhsCi	INT16S	o	yes	
DPU/MMXU0\$MX\$VAr\$PhsCq	BSTR16	o	yes	
DPU/MMXU0\$MX\$VAr\$PhsCt	BTIME6	o	yes	
DPU/MMXU0\$MX\$TotVAr\$i	INT16S	o	yes	
DPU/MMXU0\$MX\$TotVAr\$q	BSTR16	o	yes	
DPU/MMXU0\$MX\$TotVAr\$t	BTIME6	o	yes	
DPU/MMXU0\$MX\$TotVA\$i	INT16S	o	yes	
DPU/MMXU0\$MX\$TotVA\$q	BSTR16	o	yes	
DPU/MMXU0\$MX\$TotVA\$t	BTIME6	o	yes	
DPU/MMXU0\$MX\$AvgPF\$i	INT16S	o	yes	
DPU/MMXU0\$MX\$AvgPF\$q	BSTR16	o	yes	
DPU/MMXU0\$MX\$AvgPF\$t	BTIME6	o	yes	
DPU/MMXU0\$MX\$Hz\$i	INT16S	o	yes	
DPU/MMXU0\$MX\$Hz\$q	BSTR16	o	yes	
DPU/MMXU0\$MX\$Hz\$t	BTIME6	o	yes	
DPU/MMXU0\$MX\$VA		o	no	
DPU/MMXU0\$MX\$FltMagA		o	no	
DPU/MMXU0\$MX\$Amps		o	no	
DPU/MMXU0\$MX\$Volts		o	no	
DPU/MMXU0\$MX\$Watts		o	no	
DPU/MMXU0\$MX\$VoltAmpR		o	no	
DPU/MMXU0\$MX\$PwrFact		o	no	
DPU/MMXU0\$RP\$brcbMX\$RptEna	BOOL	m	yes	set to "disabled"
DPU/MMXU0\$RP\$brcbMX\$RptID	VSTR32	m	yes	set to 0
DPU/MMXU0\$RP\$brcbMX\$OptFlds	BSTR8	m	yes	set to 0
DPU/MMXU0\$RP\$brcbMX\$BufTim	INT32U	m	yes	set to 0
DPU/MMXU0\$RP\$brcbMX\$Trgs	INT16U	m	yes	set to 0
DPU/MMXU0\$RP\$brcbMX\$SqNum	INT8U	m	yes	set to 0
DPU/MMXU0\$RP\$brcbMX\$TrgOps	BSTR8	m	yes	set to 0
DPU/MMXU0\$RP\$brcbMX\$RBEPd	INT32U	m	yes	set to 0
DPU/MMXU0\$RP\$brcbMX\$IntgPd	INT32U	m	yes	set to 0

Metering – Polyphase Meter Unit (MMTR)

Polyphase Meter provides for acquiring of single phase or polyphase metering values, pertaining to a field device or circuit.

Table 5-4. Polyphase Meter Unit Model Object Definition

Logical Device/Object Name	Data Type	o/m	Supported	Description String or Comment
DPU/MMTR0\$CF\$VArHr\$s	INT32U	o	yes	
DPU/MMTR0\$CF\$VArHr\$u	ENUM8	o	yes	73 (volt ampere reactive hours)

DPU/MMTR0\$CF\$TotVArHr\$s	INT32U	o	yes	
DPU/MMTR0\$CF\$TotVArHr\$u	ENUM8	o	yes	73 (volt ampere reactive hours)
DPU/MMTR0\$CF\$WHR\$s	INT32U	o	yes	
DPU/MMTR0\$CF\$WHR\$u	ENUM8	o	yes	72 (watt hours)
DPU/MMTR0\$CF\$TotWHR\$s	INT32U	o	yes	
DPU/MMTR0\$CF\$TotWHR\$u	ENUM8	o	yes	72 (watt hours)
DPU/MMTR0\$DC\$VArHr\$d	VSTR64	o	yes	"Volt Ampere Hours, Phase A, B, C"
DPU/MMTR0\$DC\$TotVArHr\$d	VSTR64	o	yes	"Volt Ampere Hours, all 3 phases"
DPU/MMTR0\$DC\$WHR\$d	VSTR64	o	yes	"Watt Hours, Phase A, B, C"
DPU/MMTR0\$DC\$TotWHR\$d	VSTR64	o	yes	"Watt Hours, all 3 phases"
DPU/MMTR0\$MX\$WHR\$PhsAr	INT32U	o	yes	
DPU/MMTR0\$MX\$WHR\$PhsBr	INT32U	o	yes	
DPU/MMTR0\$MX\$WHR\$PhsCr	INT32U	o	yes	
DPU/MMTR0\$MX\$WHR\$qr	BSTR16	o	yes	
DPU/MMTR0\$MX\$WHR\$tr	BTIME6	o	yes	
DPU/MMTR0\$MX\$TotWHR\$r	INT32U	o	yes	
DPU/MMTR0\$MX\$TotWHR\$q	BSTR16	o	yes	
DPU/MMTR0\$MX\$TotWHR\$ft	BTIME6	o	yes	
DPU/MMTR0\$MX\$VArHr\$PhsAr	INT32U	o	yes	
DPU/MMTR0\$MX\$VArHr\$PhsBr	INT32U	o	yes	
DPU/MMTR0\$MX\$VArHr\$PhsCr	INT32U	o	yes	
DPU/MMTR0\$MX\$VArHr\$qr	BSTR16	o	yes	
DPU/MMTR0\$MX\$VArHr\$tr	BTIME6	o	yes	
DPU/MMTR0\$MX\$TotVArHr\$r	INT32U	o	yes	
DPU/MMTR0\$MX\$TotVArHr\$q	BSTR16	o	yes	
DPU/MMTR0\$MX\$TotVArHr\$ft	BTIME6	o	yes	
DPU/MMTR0\$MX\$VAHr		o	no	
DPU/MMTR0\$MX\$TotVAHr		o	no	
DPU/MMTR0\$RP\$brcbMX\$RptEna	BOOL	m	yes	set to "disabled"
DPU/MMTR0\$RP\$brcbMX\$RptID	VSTR32	m	yes	set to 0
DPU/MMTR0\$RP\$brcbMX\$OptFlds	BSTR8	m	yes	set to 0
DPU/MMTR0\$RP\$brcbMX\$BufTim	INT32U	m	yes	set to 0
DPU/MMTR0\$RP\$brcbMX\$Trgs	INT16U	m	yes	set to 0
DPU/MMTR0\$RP\$brcbMX\$SqNum	INT8U	m	yes	set to 0
DPU/MMTR0\$RP\$brcbMX\$TrgOps	BSTR8	m	yes	set to 0
DPU/MMTR0\$RP\$brcbMX\$RBEPd	INT32U	m	yes	set to 0
DPU/MMTR0\$RP\$brcbMX\$IntgPd	INT32U	m	yes	set to 0

Metering – Sequence and Imbalance Metering (MSQI)

MSQI provides for measurement of single phase or polyphase analog values representing sequence component and imbalance, pertaining to a wye or delta connected field device or circuit.

Table 5-5. Sequence and Imbalance Metering Object Model Definition

Logical Device/Object Name	Data Type	o/m	Supported	Description String or Comment
DPU/MSQI0\$CF\$SeqA\$s	INT32U	o	yes	
DPU/MSQI0\$CF\$SeqA\$u	ENUM8	o	yes	5 (ampere)
DPU/MSQI0\$CF\$SeqV\$s	INT32U	o	yes	
DPU/MSQI0\$CF\$SeqV\$u	ENUM8	o	yes	29 (volt)
DPU/MSQI0\$DC\$SeqA\$d	VSTR64	o	yes	"Pos, Neg and Zero Seq Current"
DPU/MSQI0\$DC\$SeqV\$d	VSTR64	o	yes	"Pos and Neg Seq Voltage"
DPU/MSQI0\$MX\$SeqA\$Posi	INT16S	o	yes	
DPU/MSQI0\$MX\$SeqA\$Negi	INT16S	o	yes	
DPU/MSQI0\$MX\$SeqA\$Zeroi	INT16S	o	yes	

DPU/MSQI0\$MX\$SeqA\$q	BSTR16	o	yes	
DPU/MSQI0\$MX\$SeqA\$t	BTIME6	o	yes	
DPU/MSQI0\$MX\$SeqV\$Posii	INT16S	o	yes	
DPU/MSQI0\$MX\$SeqV\$Negi	INT16S	o	yes	
DPU/MSQI0\$MX\$SeqV\$q	BSTR16	o	yes	
DPU/MSQI0\$MX\$SeqV\$t	BTIME6	o	yes	
DPU/MSQI0\$ImbA		o	no	
DPU/MSQI0\$ImbNegA		o	no	
DPU/MSQI0\$ImbNegV		o	no	
DPU/MSQI0\$ImbPPV		o	no	
DPU/MSQI0\$ImbV		o	no	
DPU/MSQI0\$ImbZroA		o	no	
DPU/MSQI0\$ImbZroV		o	no	
DPU/MSQI0\$MaxImbA		o	no	
DPU/MSQI0\$MaxImbV		o	no	
DPU/MSQI0\$RP\$brcbMX\$RptEna	BOOL	m	yes	set to "disabled"
DPU/MSQI0\$RP\$brcbMX\$RptID	VSTR32	m	yes	set to 0
DPU/MSQI0\$RP\$brcbMX\$OptFlds	BSTR8	m	yes	set to 0
DPU/MSQI0\$RP\$brcbMX\$BufTim	INT32U	m	yes	set to 0
DPU/MSQI0\$RP\$brcbMX\$Trgs	INT16U	m	yes	set to 0
DPU/MSQI0\$RP\$brcbMX\$SqNum	INT8U	m	yes	set to 0
DPU/MSQI0\$RP\$brcbMX\$TrgOps	BSTR8	m	yes	set to 0
DPU/MSQI0\$RP\$brcbMX\$RBEPd	INT32U	m	yes	set to 0
DPU/MSQI0\$RP\$brcbMX\$IntgPd	INT32U	m	yes	set to 0

Metering – Demand Metering (MDMD)

MDMD provides for measurement of single phase or polyphase analog values representing current and power demands, pertaining to a wye or delta connected field device or circuit.

Table 5-6. Demand Metering Object Model Definition

Logical Device/Object Name	Data Type	o/m	Supported	Description String or Comment
DPU/MDMD0\$CF\$A\$s	INT32U	o	yes	
DPU/MDMD0\$CF\$A\$u	ENUM8	o	yes	5 (ampere)
DPU/MDMD0\$CF\$VAr\$s	INT32U	o	yes	
DPU/MDMD0\$CF\$VAr\$u	ENUM8	o	yes	63 (volt ampere reactive)
DPU/MDMD0\$CF\$TotVAr\$s	INT32U	o	yes	
DPU/MDMD0\$CF\$TotVAr\$u	ENUM8	o	yes	63 (volt ampere reactive)
DPU/MDMD0\$CF\$W\$s	INT32U	o	yes	
DPU/MDMD0\$CF\$W\$u	ENUM8	o	yes	62 (watts)
DPU/MDMD0\$CF\$TotW\$s	INT32U	o	yes	
DPU/MDMD0\$CF\$TotW\$u	ENUM8	o	yes	62 (watts)
DPU/MDMD0\$DC\$A\$d	VSTR64	o	phase 1	"Present Phase Current Demand"
DPU/MDMD0\$DC\$VAr\$d	VSTR64	o	phase 1	"Present Reactive Power Demand"
DPU/MDMD0\$DC\$TotVAr\$d	VSTR64	o	phase 1	"Reactive Pwr Demand, 3-Ph Total"
DPU/MDMD0\$DC\$W\$d	VSTR64	o	phase 1	"Present Power Demand"
DPU/MDMD0\$DC\$TotW\$d	VSTR64	o	phase 1	"Power Demand, 3-Ph Total"
DPU/MDMD0\$MX\$A\$Neuti	INT16S	o	yes	
DPU/MDMD0\$MX\$A\$PhsAi	INT16S	o	yes	
DPU/MDMD0\$MX\$A\$PhsBi	INT16S	o	yes	
DPU/MDMD0\$MX\$A\$PhsCi	INT16S	o	yes	
DPU/MDMD0\$MX\$A\$q	BSTR16	o	yes	
DPU/MDMD0\$MX\$A\$t	BTIME6	o	yes	
DPU/MDMD0\$MX\$TotVAr\$i	INT16S	o	yes	

DPU 2000R UCA TECHNICAL GUIDE

DPU/MDMD0\$MX\$TotVAr\$q	BSTR16	o	yes	
DPU/MDMD0\$MX\$TotVAr\$t	BTIME6	o	yes	
DPU/MDMD0\$MX\$TotW\$I	INT16S	o	yes	
DPU/MDMD0\$MX\$TotW\$q	BSTR16	o	yes	
DPU/MDMD0\$MX\$TotW\$t	BTIME6	o	yes	
DPU/MDMD0\$MX\$VAr\$PhsAi	INT16S	o	yes	ABB Extentions to GOMSFE
DPU/MDMD0\$MX\$VAr\$PhsAq	BSTR16	o	yes	"
DPU/MDMD0\$MX\$VAr\$PhsAt	BTIME6	o	yes	"
DPU/MDMD0\$MX\$VAr\$PhsBi	INT16S	o	yes	"
DPU/MDMD0\$MX\$VAr\$PhsBq	BSTR16	o	yes	"
DPU/MDMD0\$MX\$VAr\$PhsBt	BTIME6	o	yes	"
DPU/MDMD0\$MX\$VAr\$PhsCi	INT16S	o	yes	"
DPU/MDMD0\$MX\$VAr\$PhsCq	BSTR16	o	yes	"
DPU/MDMD0\$MX\$VAr\$PhsCt	BTIME6	o	yes	"
DPU/MDMD0\$MX\$W\$PhsAi	INT16S	o	yes	"
DPU/MDMD0\$MX\$W\$PhsAq	BSTR16	o	yes	"
DPU/MDMD0\$MX\$W\$PhsAt	BTIME6	o	yes	"
DPU/MDMD0\$MX\$W\$PhsBi	INT16S	o	yes	"
DPU/MDMD0\$MX\$W\$PhsBq	BSTR16	o	yes	"
DPU/MDMD0\$MX\$W\$PhsBt	BTIME6	o	yes	"
DPU/MDMD0\$MX\$W\$PhsCi	INT16S	o	yes	"
DPU/MDMD0\$MX\$W\$PhsCq	BSTR16	o	yes	"
DPU/MDMD0\$MX\$W\$PhsCt	BTIME6	o	yes	"
DPU/MDMD0\$MX\$AvgA		o	no	
DPU/MDMD0\$MX\$AvgPF		o	no	
DPU/MDMD0\$MX\$CoVAAvgPF		o	no	
DPU/MDMD0\$MX\$CoVArAvgPF		o	no	
DPU/MDMD0\$MX\$CoVArVA		o	no	
DPU/MDMD0\$MX\$CoVArW		o	no	
DPU/MDMD0\$MX\$CoWVAvgPF		o	no	
DPU/MDMD0\$MX\$CoWVA		o	no	
DPU/MDMD0\$MX\$CoWVAr		o	no	
DPU/MDMD0\$MX\$CoVArW		o	no	
DPU/MDMD0\$MX\$PkA		o	no	
DPU/MDMD0\$MX\$PkAvgA		o	no	
DPU/MDMD0\$MX\$PkTotVA		o	no	
DPU/MDMD0\$MX\$PkTotVAr		o	no	
DPU/MDMD0\$MX\$PkTotW		o	no	
DPU/MDMD0\$MX\$PrdTotVA		o	no	
DPU/MDMD0\$MX\$PrdTotVAr		o	no	
DPU/MDMD0\$MX\$PrdTotW		o	no	
DPU/MDMD0\$MX\$TotVA		o	no	
DPU/MDMD0\$MX\$TotVAr		o	no	
DPU/MDMD0\$MX\$TotW		o	no	
DPU/MDMD0\$RP\$brcbMX\$RptEna	BOOL	m	yes	set to "disabled"
DPU/MDMD0\$RP\$brcbMX\$RptID	VSTR32	m	yes	set to 0
DPU/MDMD0\$RP\$brcbMX\$OptFlds	BSTR8	m	yes	set to 0
DPU/MDMD0\$RP\$brcbMX\$BufTim	INT32U	m	yes	set to 0
DPU/MDMD0\$RP\$brcbMX\$Trgs	INT16U	m	yes	set to 0
DPU/MDMD0\$RP\$brcbMX\$SqNum	INT8U	m	yes	set to 0
DPU/MDMD0\$RP\$brcbMX\$TrgOps	BSTR8	m	yes	set to 0
DPU/MDMD0\$RP\$brcbMX\$RBEPd	INT32U	m	yes	set to 0
DPU/MDMD0\$RP\$brcbMX\$IntgPd	INT32U	m	yes	set to 0

Status

The protection status is represented with GOMSFE bricks of the PBRO base class. With client software, the user can monitor logical output status, phase targets and the enabled/disabled state of the protection functions.

- Out - Present output status of the element
- Tar - Front panel targets since last reset
- FctDS - Function is enabled / disabled
- PuGrp - Settings PuGroup selected for use

The following is a list of possible DPU2000R protective functions that can be monitored:

Instantaneous Overcurrent

Table 5-7. Instantaneous Overcurrent Object Model Definition

Logical Device/Object Name	Data Type	o/m	Supported	Description String or Comment
DPU/PIOC1\$DC\$Out\$d	VSTR64	o	yes	"50P-1 Output Status"
DPU/PIOC1\$DC\$Tar\$d	VSTR64	o	yes	"50P-1 Targets since last reset"
DPU/PIOC1\$DC\$FctDS\$d	VSTR64	o	yes	"50P-1 is Enabled/Disabled"
DPU/PIOC1\$DC\$PuGrp\$d	VSTR64	o	yes	"50P-1 PuGroup Selected"
DPU/PIOC1\$ST\$Out	ENUM8	o	yes	
DPU/PIOC1\$ST\$Tar	ENUM8	o	yes	
DPU/PIOC1\$ST\$FctDS\$b2	BSTR2	o	yes	
DPU/PIOC1\$ST\$FctDS\$q	BSTR16	o	yes	
DPU/PIOC1\$ST\$FctDS\$t	BTIME6	o	yes	
DPU/PIOC1\$ST\$PuGrp	INT8U	o	yes	
DPU/PIOC1\$ST\$AuxIn<n>		o	no	
DPU/PIOC1\$CO\$EnaDisFct		o	no	
DPU/PIOC1\$CO\$RsTar		o	no	
DPU/PIOC1\$CO\$RsLat		o	no	
DPU/PIOC1\$CO\$EnaLatRs		o	no	
DPU/PIOC1\$CO\$AuxOut<n>		o	no	
DPU/PIOC1\$SG\$Pu		o	no	
DPU/PIOC1\$SG\$PuDelTim		o	no	
DPU/PIOC1\$SG\$DODelTim		o	no	
DPU/PIOC2\$DC\$Out\$d	VSTR64	o	yes	"50P-2 Output Status"
DPU/PIOC2\$DC\$Tar\$d	VSTR64	o	yes	"50P-2 Targets since last reset"
DPU/PIOC2\$DC\$FctDS\$d	VSTR64	o	yes	"50P-2 is Enabled/Disabled"
DPU/PIOC2\$DC\$PuGrp\$d	VSTR64	o	yes	"50P-2 PuGroup Selected"
DPU/PIOC2\$ST\$Out	ENUM8	o	yes	
DPU/PIOC2\$ST\$Tar	ENUM8	o	yes	
DPU/PIOC2\$ST\$FctDS\$b2	BSTR2	o	yes	
DPU/PIOC2\$ST\$FctDS\$q	BSTR16	o	yes	

DPU 2000R UCA TECHNICAL GUIDE

DPU/PIOC2\$ST\$FctDS\$t	BTIME6	0	yes	
DPU/PIOC2\$ST\$PuGrp	INT8U	0	yes	
DPU/PIOC2\$ST\$AuxIn<n>		0	no	
DPU/PIOC2\$CO\$EnaDisFct		0	no	
DPU/PIOC2\$CO\$RsTar		0	no	
DPU/PIOC2\$CO\$RsLat		0	no	
DPU/PIOC2\$CO\$EnaLatRs		0	no	
DPU/PIOC2\$CO\$AuxOut<n>		0	no	
DPU/PIOC2\$SG\$Pu		0	no	
DPU/PIOC2\$SG\$PuDelTim		0	no	
DPU/PIOC2\$SG\$DODelTim		0	no	
DPU/PIOC3\$DC\$Out\$d	VSTR64	0	yes	"50P-3 Output Status"
DPU/PIOC3\$DC\$Tar\$d	VSTR64	0	yes	"50P-3 Targets since last reset"
DPU/PIOC3\$DC\$FctDS\$d	VSTR64	0	yes	"50P-3 is Enabled/Disabled"
DPU/PIOC3\$DC\$PuGrp\$d	VSTR64	0	yes	"50P-3 PuGroup Selected"
DPU/PIOC3\$ST\$Out	ENUM8	0	yes	
DPU/PIOC3\$ST\$Tar	ENUM8	0	yes	
DPU/PIOC3\$ST\$FctDS\$b2	BSTR2	0	yes	
DPU/PIOC3\$ST\$FctDS\$q	BSTR16	0	yes	
DPU/PIOC3\$ST\$FctDS\$t	BTIME6	0	yes	
DPU/PIOC3\$ST\$PuGrp	INT8U	0	yes	
DPU/PIOC3\$ST\$AuxIn<n>		0	no	
DPU/PIOC3\$CO\$EnaDisFct		0	no	
DPU/PIOC3\$CO\$RsTar		0	no	
DPU/PIOC3\$CO\$RsLat		0	no	
DPU/PIOC3\$CO\$EnaLatRs		0	no	
DPU/PIOC3\$CO\$AuxOut<n>		0	no	
DPU/PIOC3\$SG\$Pu		0	no	
DPU/PIOC3\$SG\$PuDelTim		0	no	
DPU/PIOC3\$SG\$DODelTim		0	no	
DPU/PIOC4\$DC\$Out\$d	VSTR64	0	yes	"50N-1 Output Status"
DPU/PIOC4\$DC\$Tar\$d	VSTR64	0	yes	"50N-1 Targets since last reset"
DPU/PIOC4\$DC\$FctDS\$d	VSTR64	0	yes	"50N-1 is Enabled/Disabled"
DPU/PIOC4\$DC\$PuGrp\$d	VSTR64	0	yes	"50N-1 PuGroup Selected"
DPU/PIOC4\$ST\$Out	ENUM8	0	yes	
DPU/PIOC4\$ST\$Tar	ENUM8	0	yes	
DPU/PIOC4\$ST\$FctDS\$b2	BSTR2	0	yes	
DPU/PIOC4\$ST\$FctDS\$q	BSTR16	0	yes	
DPU/PIOC4\$ST\$FctDS\$t	BTIME6	0	yes	
DPU/PIOC4\$ST\$PuGrp	INT8U	0	yes	
DPU/PIOC4\$ST\$AuxIn<n>		0	no	
DPU/PIOC4\$CO\$EnaDisFct		0	no	
DPU/PIOC4\$CO\$RsTar		0	no	
DPU/PIOC4\$CO\$RsLat		0	no	
DPU/PIOC4\$CO\$EnaLatRs		0	no	
DPU/PIOC4\$CO\$AuxOut<n>		0	no	
DPU/PIOC4\$SG\$Pu		0	no	
DPU/PIOC4\$SG\$PuDelTim		0	no	
DPU/PIOC4\$SG\$DODelTim		0	no	
DPU/PIOC5\$DC\$Out\$d	VSTR64	0	yes	"50N-2 Output Status"
DPU/PIOC5\$DC\$Tar\$d	VSTR64	0	yes	"50N-2 Targets since last reset"
DPU/PIOC5\$DC\$FctDS\$d	VSTR64	0	yes	"50N-2 is Enabled/Disabled"
DPU/PIOC5\$DC\$PuGrp\$d	VSTR64	0	yes	"50N-2 PuGroup Selected"
DPU/PIOC5\$ST\$Out	ENUM8	0	yes	
DPU/PIOC5\$ST\$Tar	ENUM8	0	yes	

DPU/PIOC5\$ST\$FctDS\$b2	BSTR2	o	yes	
DPU/PIOC5\$ST\$FctDS\$q	BSTR16	o	yes	
DPU/PIOC5\$ST\$FctDS\$t	BTIME6	o	yes	
DPU/PIOC5\$ST\$PuGrp	INT8U	o	yes	
DPU/PIOC5\$ST\$AuxIn<n>		o	no	
DPU/PIOC5\$CO\$EnaDisFct		o	no	
DPU/PIOC5\$CO\$RsTar		o	no	
DPU/PIOC5\$CO\$RsLat		o	no	
DPU/PIOC5\$CO\$EnaLatRs		o	no	
DPU/PIOC5\$CO\$AuxOut<n>		o	no	
DPU/PIOC5\$SG\$Pu		o	no	
DPU/PIOC5\$SG\$PuDelTim		o	no	
DPU/PIOC5\$SG\$DODelTim		o	no	
DPU/PIOC6\$DC\$Out\$d	VSTR64	o	yes	"50N-3 Output Status"
DPU/PIOC6\$DC\$Tar\$d	VSTR64	o	yes	"50N-3 Targets since last reset"
DPU/PIOC6\$DC\$FctDS\$d	VSTR64	o	yes	"50N-3 is Enabled/Disabled"
DPU/PIOC6\$DC\$PuGrp\$d	VSTR64	o	yes	"50N-3 PuGroup Selected"
DPU/PIOC6\$ST\$Out	ENUM8	o	yes	
DPU/PIOC6\$ST\$Tar	ENUM8	o	yes	
DPU/PIOC6\$ST\$FctDS\$b2	BSTR2	o	yes	
DPU/PIOC6\$ST\$FctDS\$q	BSTR16	o	yes	
DPU/PIOC6\$ST\$FctDS\$t	BTIME6	o	yes	
DPU/PIOC6\$ST\$PuGrp	INT8U	o	yes	
DPU/PIOC6\$ST\$AuxIn<n>		o	no	
DPU/PIOC6\$CO\$EnaDisFct		o	no	
DPU/PIOC6\$CO\$RsTar		o	no	
DPU/PIOC6\$CO\$RsLat		o	no	
DPU/PIOC6\$CO\$EnaLatRs		o	no	
DPU/PIOC6\$CO\$AuxOut<n>		o	no	
DPU/PIOC6\$SG\$Pu		o	no	
DPU/PIOC6\$SG\$PuDelTim		o	no	
DPU/PIOC6\$SG\$DODelTim		o	no	

Ground Time Overcurrent

Table 5-8. Ground Overcurrent Object Model Definition

Logical Device/Object Name	Data Type	o/m	Supported	Description String or Comment
DPU/PTOC1\$DC\$Out\$d	VSTR64	o	yes	"51P Output Status"
DPU/PTOC1\$DC\$Tar\$d	VSTR64	o	yes	"51P Targets since last reset"
DPU/PTOC1\$DC\$FctDS\$d	VSTR64	o	yes	"51P is Enabled/Disabled"
DPU/PTOC1\$DC\$PuGrp\$d	VSTR64	o	yes	"51P PuGroup Selected"
DPU/PTOC1\$ST\$Out	ENUM8	o	yes	
DPU/PTOC1\$ST\$Tar	ENUM8	o	yes	
DPU/PTOC1\$ST\$FctDS\$b2	BSTR2	o	yes	
DPU/PTOC1\$ST\$FctDS\$q	BSTR16	o	yes	
DPU/PTOC1\$ST\$FctDS\$t	BTIME6	o	yes	
DPU/PTOC1\$ST\$PuGrp	INT8U	o	yes	
DPU/PTOC1\$ST\$AuxIn<n>		o	no	
DPU/PTOC1\$CO\$EnaDisFct		o	no	
DPU/PTOC1\$CO\$RsTar		o	no	
DPU/PTOC1\$CO\$RsLat		o	no	
DPU/PTOC1\$CO\$EnaLatRs		o	no	
DPU/PTOC1\$CO\$AuxOut<n>		o	no	
DPU/PTOC1\$SG\$Pu		o	no	

DPU/PTOC1\$SG\$PuDelTim		o	no	
DPU/PTOC1\$SG\$DODelTim		o	no	
DPU/PTOC2\$DC\$Out\$d	VSTR64	o	yes	"51N Output Status"
DPU/PTOC2\$DC\$Tar\$d	VSTR64	o	yes	"51N Targets since last reset"
DPU/PTOC2\$DC\$FctDS\$d	VSTR64	o	yes	"51N is Enabled/Disabled"
DPU/PTOC2\$DC\$PuGrp\$d	VSTR64	o	yes	"51N PuGroup Selected"
DPU/PTOC2\$ST\$Out	ENUM8	o	yes	
DPU/PTOC2\$ST\$Tar	ENUM8	o	yes	
DPU/PTOC2\$ST\$FctDS\$b2	BSTR2	o	yes	
DPU/PTOC2\$ST\$FctDS\$q	BSTR16	o	yes	
DPU/PTOC2\$ST\$FctDS\$t	BTIME6	o	yes	
DPU/PTOC2\$ST\$PuGrp	INT8U	o	yes	
DPU/PTOC2\$ST\$AuxIn<n>		o	no	
DPU/PTOC2\$CO\$EnaDisFct		o	no	
DPU/PTOC2\$CO\$RsTar		o	no	
DPU/PTOC2\$CO\$RsLat		o	no	
DPU/PTOC2\$CO\$EnaLatRs		o	no	
DPU/PTOC2\$CO\$AuxOut<n>		o	no	
DPU/PTOC2\$SG\$Pu		o	no	
DPU/PTOC2\$SG\$PuDelTim		o	no	
DPU/PTOC2\$SG\$DODelTim		o	no	

Directional Overcurrent

Table 5-9. Directional Overcurrent Object Model Definition

Logical Device/Object Name	Data Type	o/m	Supported	Description String or Comment
DPU/PDOC1\$DC\$Out\$d	VSTR64	o	yes	"67P Output Status"
DPU/PDOC1\$DC\$Tar\$d	VSTR64	o	yes	"67P Targets since last reset"
DPU/PDOC1\$DC\$FctDS\$d	VSTR64	o	yes	"67P is Enabled/Disabled"
DPU/PDOC1\$DC\$PuGrp\$d	VSTR64	o	yes	"67P PuGroup Selected"
DPU/PDOC1\$ST\$Out	ENUM8	o	yes	
DPU/PDOC1\$ST\$Tar	ENUM8	o	yes	
DPU/PDOC1\$ST\$FctDS\$b2	BSTR2	o	yes	
DPU/PDOC1\$ST\$FctDS\$q	BSTR16	o	yes	
DPU/PDOC1\$ST\$FctDS\$t	BTIME6	o	yes	
DPU/PDOC1\$ST\$PuGrp	INT8U	o	yes	
DPU/PDOC1\$ST\$AuxIn<n>		o	no	
DPU/PDOC1\$CO\$EnaDisFct		o	no	
DPU/PDOC1\$CO\$RsTar		o	no	
DPU/PDOC1\$CO\$RsLat		o	no	
DPU/PDOC1\$CO\$EnaLatRs		o	no	
DPU/PDOC1\$CO\$AuxOut<n>		o	no	
DPU/PDOC1\$SG\$Pu		o	no	
DPU/PDOC1\$SG\$PuDelTim		o	no	
DPU/PDOC1\$SG\$DODelTim		o	no	
DPU/PDOC2\$DC\$Out\$d	VSTR64	o	yes	"67N Output Status"
DPU/PDOC2\$DC\$Tar\$d	VSTR64	o	yes	"67N Targets since last reset"
DPU/PDOC2\$DC\$FctDS\$d	VSTR64	o	yes	"67N is Enabled/Disabled"
DPU/PDOC2\$DC\$PuGrp\$d	VSTR64	o	yes	"67N PuGroup Selected"
DPU/PDOC2\$ST\$Out	ENUM8	o	yes	
DPU/PDOC2\$ST\$Tar	ENUM8	o	yes	
DPU/PDOC2\$ST\$FctDS\$b2	BSTR2	o	yes	
DPU/PDOC2\$ST\$FctDS\$q	BSTR16	o	yes	
DPU/PDOC2\$ST\$FctDS\$t	BTIME6	o	yes	

DPU/PDOC2\$ST\$PuGrp	INT8U	o	yes	
DPU/PDOC2\$ST\$AuxIn<n>		o	no	
DPU/PDOC2\$CO\$EnaDisFct		o	no	
DPU/PDOC2\$CO\$RsTar		o	no	
DPU/PDOC2\$CO\$RsLat		o	no	
DPU/PDOC2\$CO\$EnaLatRs		o	no	
DPU/PDOC2\$CO\$AuxOut<n>		o	no	
DPU/PDOC2\$SG\$Pu		o	no	
DPU/PDOC2\$SG\$PuDelTim		o	no	
DPU/PDOC2\$SG\$DODelTim		o	no	

Phase Balance Current Relay

Table 5-10. Phase Balance Current Object Model Definition

Logical Device/Object Name	Data Type	o/m	Supported	Description String or Comment
DPU/PBRL1\$DC\$Out\$d	VSTR64	o	yes	"46P Output Status"
DPU/PBRL1\$DC\$Tar\$d	VSTR64	o	yes	"46P Targets since last reset"
DPU/PBRL1\$DC\$FctDS\$d	VSTR64	o	yes	"46P is Enabled/Disabled"
DPU/PBRL1\$DC\$PuGrp\$d	VSTR64	o	yes	"46P PuGroup Selected"
DPU/PBRL1\$ST\$Out	ENUM8	o	yes	
DPU/PBRL1\$ST\$Tar	ENUM8	o	yes	
DPU/PBRL1\$ST\$FctDS\$b2	BSTR2	o	yes	
DPU/PBRL1\$ST\$FctDS\$q	BSTR16	o	yes	
DPU/PBRL1\$ST\$FctDS\$t	BTIME6	o	yes	
DPU/PBRL1\$ST\$PuGrp	INT8U	o	yes	
DPU/PBRL1\$ST\$AuxIn<n>		o	no	
DPU/PBRL1\$CO\$EnaDisFct		o	no	
DPU/PBRL1\$CO\$RsTar		o	no	
DPU/PBRL1\$CO\$RsLat		o	no	
DPU/PBRL1\$CO\$EnaLatRs		o	no	
DPU/PBRL1\$CO\$AuxOut<n>		o	no	
DPU/PBRL1\$SG\$Pu		o	no	
DPU/PBRL1\$SG\$PuDelTim		o	no	
DPU/PBRL1\$SG\$DODelTim		o	no	

Directional Power Relay

Table 5-11. Directional Power Element Object Model Definition

Logical Device/Object Name	Data Type	o/m	Supported	Description String or Comment
DPU/PDPR1\$DC\$Out\$d	VSTR64	o	yes	"32P Output Status"
DPU/PDPR1\$DC\$Tar\$d	VSTR64	o	yes	"32P Targets since last reset"
DPU/PDPR1\$DC\$FctDS\$d	VSTR64	o	yes	"32P is Enabled/Disabled"
DPU/PDPR1\$DC\$PuGrp\$d	VSTR64	o	yes	"32P PuGroup Selected"
DPU/PDPR1\$ST\$Out	ENUM8	o	yes	
DPU/PDPR1\$ST\$Tar	ENUM8	o	yes	
DPU/PDPR1\$ST\$FctDS\$b2	BSTR2	o	yes	
DPU/PDPR1\$ST\$FctDS\$q	BSTR16	o	yes	
DPU/PDPR1\$ST\$FctDS\$t	BTIME6	o	yes	
DPU/PDPR1\$ST\$PuGrp	INT8U	o	yes	
DPU/PDPR1\$ST\$AuxIn<n>		o	no	
DPU/PDPR1\$CO\$EnaDisFct		o	no	
DPU/PDPR1\$CO\$RsTar		o	no	
DPU/PDPR1\$CO\$RsLat		o	no	

DPU/PDPR1\$CO\$EnaLatRs		o	no	
DPU/PDPR1\$CO\$AuxOut<n>		o	no	
DPU/PDPR1\$SG\$Pu		o	no	
DPU/PDPR1\$SG\$PuDelTim		o	no	
DPU/PDPR1\$SG\$DODelTim		o	no	
DPU/PDPR2\$DC\$Out\$d	VSTR64	o	yes	"32N Output Status"
DPU/PDPR2\$DC\$Tar\$d	VSTR64	o	yes	"32N Targets since last reset"
DPU/PDPR2\$DC\$FctDS\$d	VSTR64	o	yes	"32N is Enabled/Disabled"
DPU/PDPR2\$DC\$PuGrp\$d	VSTR64	o	yes	"32N PuGroup Selected"
DPU/PDPR2\$ST\$Out	ENUM8	o	yes	
DPU/PDPR2\$ST\$Tar	ENUM8	o	yes	
DPU/PDPR2\$ST\$FctDS\$b2	BSTR2	o	yes	
DPU/PDPR2\$ST\$FctDS\$q	BSTR16	o	yes	
DPU/PDPR2\$ST\$FctDS\$t	BTIME6	o	yes	
DPU/PDPR2\$ST\$PuGrp	INT8U	o	yes	
DPU/PDPR2\$ST\$AuxIn<n>		o	no	
DPU/PDPR2\$CO\$EnaDisFct		o	no	
DPU/PDPR2\$CO\$RsTar		o	no	
DPU/PDPR2\$CO\$RsLat		o	no	
DPU/PDPR2\$CO\$EnaLatRs		o	no	
DPU/PDPR2\$CO\$AuxOut<n>		o	no	
DPU/PDPR2\$SG\$Pu		o	no	
DPU/PDPR2\$SG\$PuDelTim		o	no	
DPU/PDPR2\$SG\$DODelTim		o	no	

Under Voltage Relay

Table 5-12. Under Voltage Element Object Model Definition

Logical Device/Object Name	Data Type	o/m	Supported	Description String or Comment
DPU/PUVR1\$DC\$Out\$d	VSTR64	o	yes	"27 Output Status"
DPU/PUVR1\$DC\$Tar\$d	VSTR64	o	yes	"27 Targets since last reset"
DPU/PUVR1\$DC\$FctDS\$d	VSTR64	o	yes	"27 is Enabled/Disabled"
DPU/PUVR1\$DC\$PuGrp\$d	VSTR64	o	yes	"27 PuGroup Selected"
DPU/PUVR1\$ST\$Out	ENUM8	o	yes	
DPU/PUVR1\$ST\$Tar	ENUM8	o	yes	
DPU/PUVR1\$ST\$FctDS\$b2	BSTR2	o	yes	
DPU/PUVR1\$ST\$FctDS\$q	BSTR16	o	yes	
DPU/PUVR1\$ST\$FctDS\$t	BTIME6	o	yes	
DPU/PUVR1\$ST\$PuGrp	INT8U	o	yes	
DPU/PUVR1\$ST\$AuxIn<n>		o	no	
DPU/PUVR1\$CO\$EnaDisFct		o	no	
DPU/PUVR1\$CO\$RsTar		o	no	
DPU/PUVR1\$CO\$RsLat		o	no	
DPU/PUVR1\$CO\$EnaLatRs		o	no	
DPU/PUVR1\$CO\$AuxOut<n>		o	no	
DPU/PUVR1\$SG\$Pu		o	no	
DPU/PUVR1\$SG\$PuDelTim		o	no	
DPU/PUVR1\$SG\$DODelTim		o	no	

Over Voltage Relay

Table 5-13. Over Voltage Element Object Model Definition

Logical Device/Object Name	Data Type	o/m	Supported	Description String or Comment
----------------------------	-----------	-----	-----------	-------------------------------

DPU/POVR1\$DC\$Out\$d	VSTR64	o	yes	"59 Output Status"
DPU/POVR1\$DC\$Tar\$d	VSTR64	o	yes	"59 Targets since last reset"
DPU/POVR1\$DC\$FctDS\$d	VSTR64	o	yes	"59 is Enabled/Disabled"
DPU/POVR1\$DC\$PuGrp\$d	VSTR64	o	yes	"59 PuGroup Selected"
DPU/POVR1\$ST\$Out	ENUM8	o	yes	
DPU/POVR1\$ST\$Tar	ENUM8	o	yes	
DPU/POVR1\$ST\$FctDS\$b2	BSTR2	o	yes	
DPU/POVR1\$ST\$FctDS\$q	BSTR16	o	yes	
DPU/POVR1\$ST\$FctDS\$t	BTIME6	o	yes	
DPU/POVR1\$ST\$PuGrp	INT8U	o	yes	
DPU/POVR1\$ST\$AuxIn<n>		o	no	
DPU/POVR1\$CO\$EnaDisFct		o	no	
DPU/POVR1\$CO\$RsTar		o	no	
DPU/POVR1\$CO\$RsLat		o	no	
DPU/POVR1\$CO\$EnaLatRs		o	no	
DPU/POVR1\$CO\$AuxOut<n>		o	no	
DPU/POVR1\$SG\$Pu		o	no	
DPU/POVR1\$SG\$PuDelTim		o	no	
DPU/POVR1\$SG\$DODelTim		o	no	

Control Objects

Within the object modeling, Circuit Breaker Control and various reset of counters is implemented on the UCA Board. GOOSE is present, however all DNA bits are not supported, only those related to breaker open and breaker close control features.

Circuit Breaker (XCBR)

Monitoring of Breaker Status as well as manual control of the Breaker is accomplished with the XCBR brick.

Table 5-14. XCBR Control Object Model Definition

Logical Device/Object Name	Data Type	o/m	Supported	Description String or Comment
DPU/XCBR0\$CF\$ODSw\$OnDur	INT32U	m	yes	
DPU/XCBR0\$CF\$ODSw\$OffDur	INT32U	m	yes	
DPU/XCBR0\$CF\$BkrCntRs\$OnDur	INT32U	o	yes	Extension to XCBR for DPU
DPU/XCBR0\$CF\$BkrCntRs\$OffDur	INT32U	o	yes	Extension to XCBR for DPU
DPU/XCBR0\$CO\$ODSw\$b2	BSTR2	m	yes	
DPU/XCBR0\$CO\$ODSw\$SBO	IDENT	m	yes	
DPU/XCBR0\$CO\$BkrCntRs\$b1	BSTR1	o	yes	Extension to XCBR for DPU
DPU/XCBR0\$DC\$ODSw\$d	VSTR64	o	yes	"Breaker Open/Close Command"
DPU/XCBR0\$DC\$SwD\$d	VSTR64	o	yes	"Breaker State"
DPU/XCBR0\$DC\$BkrCnt\$d	VSTR64	o	yes	"Breaker Operations Count"
DPU/XCBR0\$DC\$BkrCnt\$d	VSTR64	o	yes	"Breaker Operations Count Reset"
DPU/XCBR0\$MX\$BkrCnt\$I	INT32U		yes	ABB Extension to XCBR
DPU/XCBR0\$MX\$BkrCnt\$q	BSTR16		yes	"
DPU/XCBR0\$MX\$BkrCnt\$t	BTIME6		yes	"
DPU/XCBR0\$SP\$LoPresAlm		o	no	
DPU/XCBR0\$SP\$LoPresLO		o	no	
DPU/XCBR0\$SP\$HiPresAlm		o	no	
DPU/XCBR0\$SP\$LoDenAlm		o	no	
DPU/XCBR0\$SP\$LoDenLO		o	no	
DPU/XCBR0\$SP\$HiDenAlm		o	no	
DPU/XCBR0\$SP\$LoLevAlm		o	no	
DPU/XCBR0\$SP\$LoLevLO		o	no	

DPU/XCBR0\$SP\$HiLevAlm		o	no	
DPU/XCBR0\$SP\$PoleDiscTim		o	no	
DPU/XCBR0\$ST\$SwDs\$b2	BSTR2	o	yes	
DPU/XCBR0\$ST\$SwDs\$q	BSTR16	o	yes	
DPU/XCBR0\$ST\$SwDs\$t	BTIME6	o	yes	
DPU/XCBR0\$ST\$SwPoleDS		o	no	
DPU/XCBR0\$ST\$UneqPoleDS		o	no	
DPU/XCBR0\$ST\$PwrSupSt		o	no	
DPU/XCBR0\$ST\$PresSt		o	no	
DPU/XCBR0\$ST\$Den		o	no	
DPU/XCBR0\$ST\$LevSt		o	no	
DPU/XCBR0\$ST\$PmpMotSt		o	no	
DPU/XCBR0\$ST\$PoleDiscSt		o	no	
DPU/XCBR0\$ST\$BlkSwSt		o	no	
DPU/XCBR0\$ST\$TrpCoil\$b1	BSTR1	o	no	
DPU/XCBR0\$ST\$TrpCoil\$q	BSTR16	o	no	
DPU/XCBR0\$ST\$TrpCoil\$t	BTIME6	o	no	

Reset Front Panel Fault Indicators / Reset of Sealed Outputs

The DPU2000R's front panel fault indicators, demands, counters, and ULO's will have read / write reset capability via a standard UCA test client. A list of the reset parameters is listed below:

Reset of All Fault Indicators

This function resets ALL front panel targets and ALL sealed alarms.

DPU/GLOBE\$CO\$IndRs\$b1

Reset Demand Counters

Currently this function resets the min / max demand values, not the currently running sums of the demand voltages and currents. Should these min / max values be available via client software?

The UCA spec also states the counters can be reset to a predefined value of 0.

DPU/MDMD0\$CO\$RsAll\$b1

Reset Circuit Breaker Counters

The UCA spec also states the counters should be able to be reset to a predefined value of 0. The function to perform the reset is:

DPU/XCBR0\$CO\$RsBkrCntr\$b1

Reset New Fault Indication, New Oscillographic Record Indication or New Operation Record Indication

The above indications will be automatically reset when the user retrieves Fault, Oscillographic or Operation Records via FTP file transfer protocol over Ethernet. No User reset of these indications is available.

Network Time Synchronization

The purpose of network time synchronisation is to ensure that all IED's on the ethernet have the same time. Network time synchronisation will be provided via the Tamarack test client or Base software package. When the 2000R boots, it sets the time on the ethernet card to its own time. When a network time synchronisation signal is sent across the network, all UCA compliant devices will have the same time.

GOOSE – Peer to Peer Communication

GOOSE messaging structure is supported within the DPU 2000R UCA Ethernet card. However only two bits are supported in the card. The functions are "hard coded" in the UCA messaging structure and are not configurable.

Circuit Breaker Trip / Close

Circuit Breaker Status

Post Fault Indication Objects

Within the DPU 2000R, several methods to obtain Fault Indication are present. One method is to obtain the aggregate fault record using the FIND object. The following structure and supported bricks within the UCA object implementation is as follows:

Last Fault Indication (FIND)

Information about the last fault recorded by the DPU may be found in the GOMSFE FIND brick.

Table 5-15. Fault Indication Object Model Definition Supported in the DPU2000R Ethernet UCA Board

Logical Device/Object Name	Data Type	o/m	Supported	Description String or Comment
DPU/FIND0\$CF\$FltMagA\$s	INT32U	o	yes	
DPU/FIND0\$CF\$FltMagA\$u	ENUM8	o	yes	5 (ampere)
DPU/FIND0\$CF\$FltDist\$s	INT32U	o	yes	
DPU/FIND0\$CF\$FltDist\$u	ENUM8	o	yes	2 (eter)
DPU/FIND0\$DC\$FltMagA\$d	VSTR64	o	yes	"Flt Mag Current A,B,C,N"
DPU/FIND0\$DC\$FltDist\$d	VSTR64	o	yes	"Fault Distance"
DPU/FIND0\$MX\$FltMagA\$Neuti	INT16S	o	yes	
DPU/FIND0\$MX\$FltMagA\$PhsNAngi	INT16S	o	yes	
DPU/FIND0\$MX\$FltMagA\$Neutq	BSTR16	o	yes	
DPU/FIND0\$MX\$FltMagA\$Neutt	BTIME6	o	yes	
DPU/FIND0\$MX\$FltMagA\$PhsAi	INT16S	o	yes	
DPU/FIND0\$MX\$FltMagA\$PhsAAngi	INT16S	o	yes	
DPU/FIND0\$MX\$FltMagA\$PhsAq	BSTR16	o	yes	
DPU/FIND0\$MX\$FltMagA\$PhsAt	BTIME6	o	yes	
DPU/FIND0\$MX\$FltMagA\$PhsBi	INT16S	o	yes	
DPU/FIND0\$MX\$FltMagA\$PhsBAngi	INT16S	o	yes	
DPU/FIND0\$MX\$FltMagA\$PhsBq	BSTR16	o	yes	
DPU/FIND0\$MX\$FltMagA\$PhsBt	BTIME6	o	yes	
DPU/FIND0\$MX\$FltMagA\$PhsCi	INT16S	o	yes	
DPU/FIND0\$MX\$FltMagA\$PhsCAngi	INT16S	o	yes	
DPU/FIND0\$MX\$FltMagA\$PhsCq	BSTR16	o	yes	
DPU/FIND0\$MX\$FltMagA\$PhsCt	BTIME6	o	yes	
DPU/FIND0\$MX\$FltDist\$I	INT16S	o	yes	ABB extension to GOMSFE
DPU/FIND0\$MX\$FltDist\$q	BSTR16	o	yes	"
DPU/FIND0\$MX\$FltDist\$t	BTIME6	o	yes	"
DPU/FIND0\$CO\$FIRs		o	no	
DPU/FIND0\$SP\$FIPuThre		o	no	
DPU/FIND0\$SP\$FIPuHyst		o	no	
DPU/FIND0\$SP\$FIInrushDel		o	no	
DPU/FIND0\$SP\$FIZeroThre		o	no	
DPU/FIND0\$SP\$FIRsTmr		o	no	
DPU/FIND0\$ST\$FIA		o	no	
DPU/FIND0\$ST\$FIB		o	no	

DPU/FIND0\$ST\$FIC		o	no	
DPU/FIND0\$ST\$FIN		o	no	

Oscillographic Record Retrieval

Oscillographic records can be extracted from the DPU2000R by using a standard web browser from Netscape or Internet Explorer Version 5.0 from Microsoft, from an initiated FTP session. The waveform file will be in Comtrade file format and can be immediately imported by ABB's Wavewin package for examination by the user.

Since the DPU 2000R UCA card is both a client and a server, the DPU 2000R can act as an FTP server for data file storage.

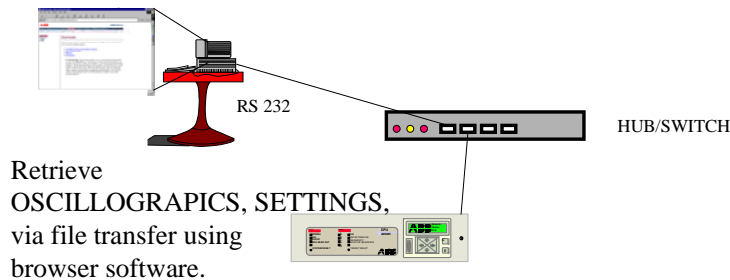

- FTP:// COMTRADE FILE RETREIVAL USING A STANDARD BROWSER.

Figure 5-3. FTP COMTRADE File Upload

As illustrated in Figure 5-3, a standard computer is attached to a hub in which an ABB DPU 2000R relay with Internet Explorer 5.0 installed is operating. The address of the relay is 198.113.65.110
When executing Internet Explorer, initially, three subdirectories are present
OSCILLOGRPH
FAULTREC
OPERREC

Files are contained beneath these directories on the FTP site as illustrated in Figure 5-4.

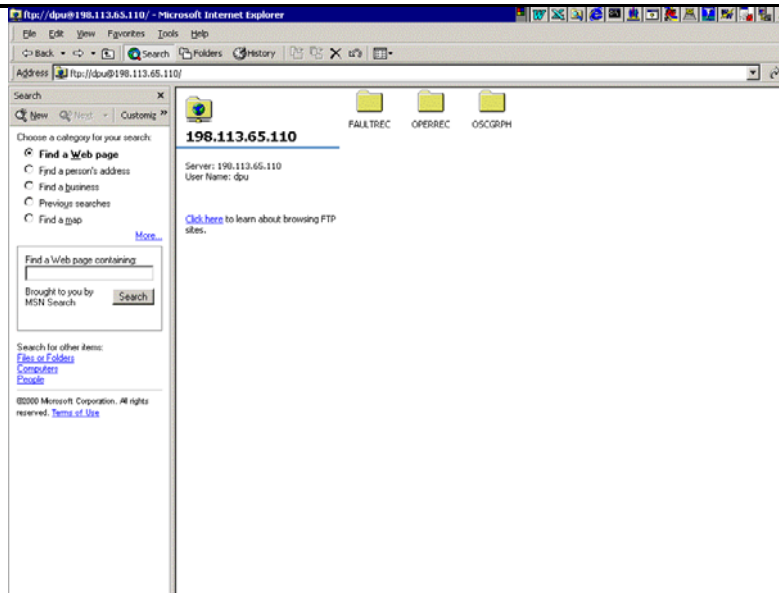

Figure 5-4. FTP Screen for Access of Fault, Oscillographic, and Operation Files

As illustrated in Figure 5-4, the method to access the FTP is listed on the browser screen capture.

If one selects the file folder “OSCGRPH”, several subdirectories may be visible representing the COMTRADE oscillographic records present in the relay. If several oscillographic files are present in the DPU 2000R, then several subdirectories are visible. This is illustrated in Figure 5-5. If there are no oscillographic records present in the relay, then no subdirectories will be visible.

If one would then select a specific REC X file, then the COMTRADE files for that record are visible as illustrated in Figure 5-6. These files can be viewed using the ABB utility WAVEWIN. The filename is composed of the date MM/DD/YY_ Time in MS of the fault.

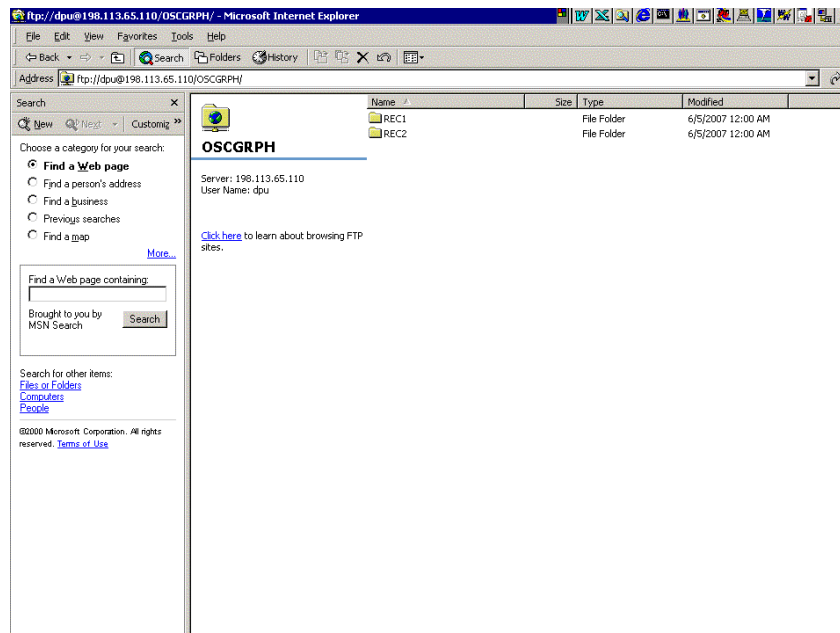

Figure 5-5. Oscillographic COMTRADE File Subdirectories

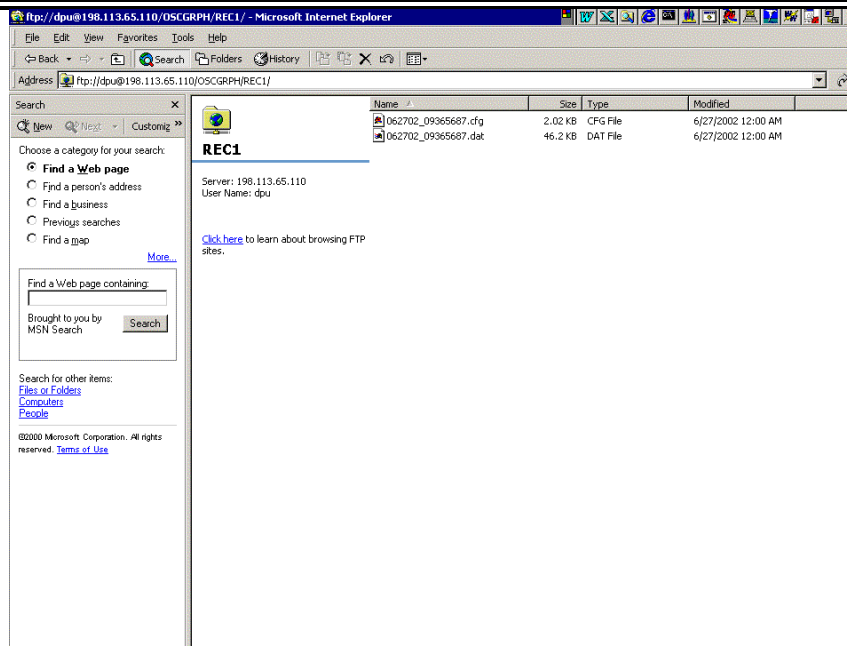

Figure 5-6. COMTRADE Files Available Using a Browser Utility

Fault Record Retrieval

Fault records can be extracted from the DPU2000R by using a standard web browser from Netscape or Internet Explorer Version 5.0 from Microsoft, from an initiated FTP session. The format is a standard text file listing the time and dates for of each fault recorded in the relay. If one selects the subdirectory for FLTREC, (Fault Records), additional files will be available to extract and view. Figure 5-7 illustrates the file structure for Fault Record archival. The files are stored in ASCII TEXT format and may be viewed using the Windows WORDPAD utility. Figure 5-8 gives an example of the fault record storage within the relay.

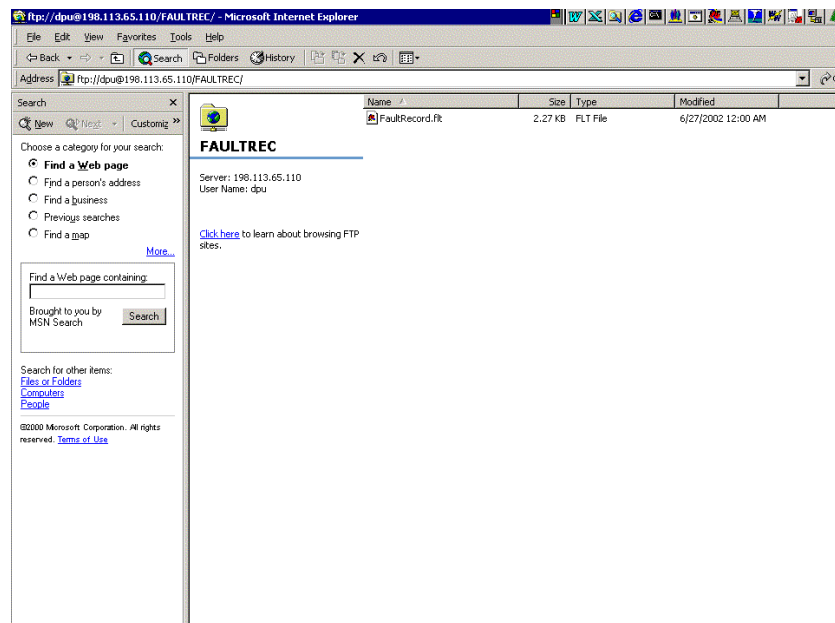

Figure 5-7. FTP Fault Record Archive in the UCA Server

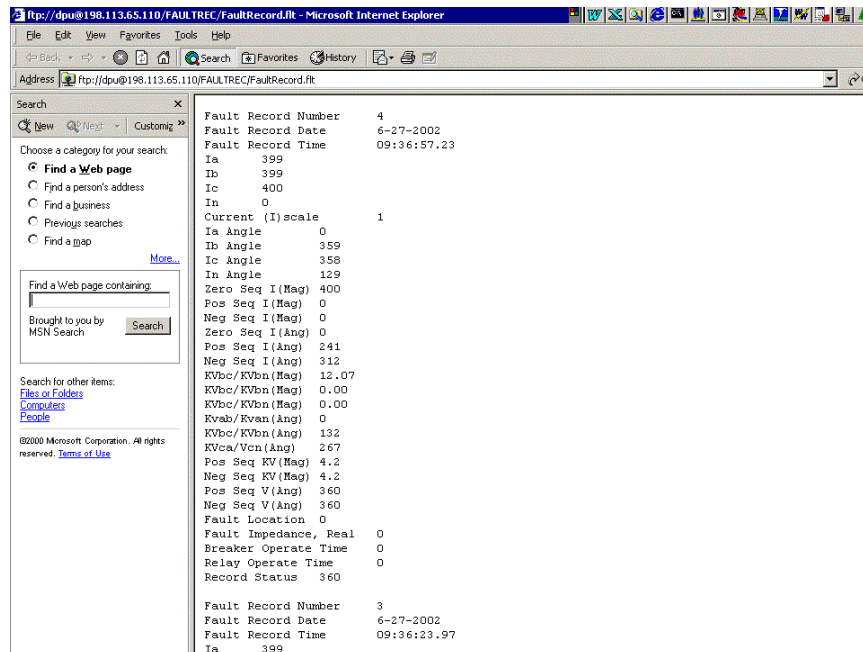

Figure 5-8. Example Fault Record Text File Contents

Operation Records

Operation records can be extracted from the DPU2000R by using a standard web browser from Netscape or Internet Explorer Version 5.0 from Microsoft, from an initiated FTP session. The format is a standard text file listing the time and dates for of each Operation recorded in the relay.

If the OPERREC file is selected via the browser, an additional Operation record file tree will be visible. The extension of the file is *.opr. An example Operation record file retrieved from the UCA card is visible in Figure 5-9. If the file is uploaded from the IED and displayed via a text reader utility such as WORDPAD, its contents would be viewable as illustrated in Figure 5-10.

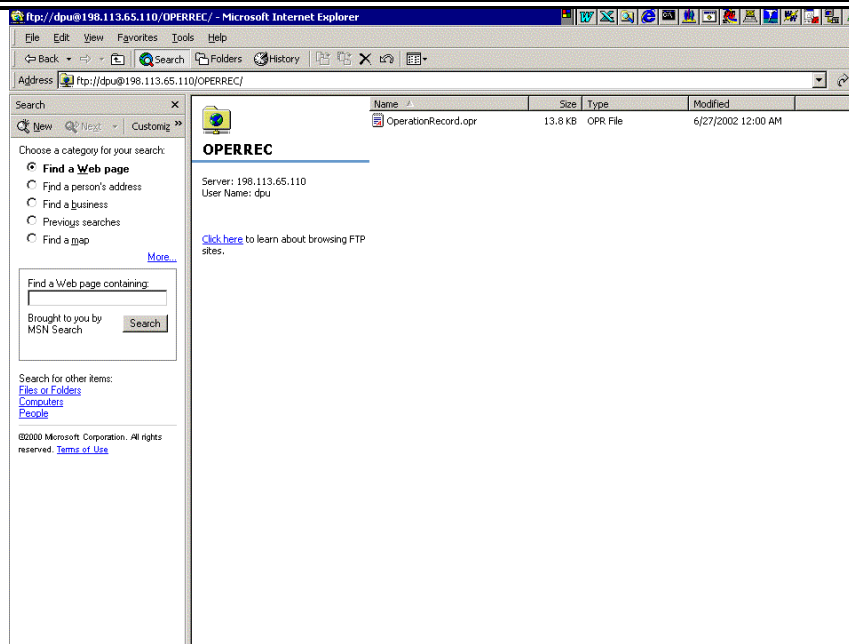

Figure 5-9. Operation Record File Archival

In order to interpret the OPERATION RECORD, Table 5-16 lists the OPERATION RECORD codes available for the DPU 2000R.

Table 5-16. Operation Record Data

Operation Record Type	
Operation Number	Definitions
00	51P Trip
01	51N Trip
02	50P-1 Trip
03	50N-1 Trip
04	50P-2 Trip
05	50N-2 Trip
06	50P-3 Trip
07	50N-3 Trip
08	67P Trip (DPU2000/R)
09	67N Trip (DPU2000/R)
10	46 Trip
11	27-1P Alarm
12	59 Alarm (DPU2000/R)
13	79V Block
14	81S-1 Trip (DPU2000/R)
15	81R-1 Restore (DPU2000/R)
16	81V Block (DPU2000/R)
17	TOC Pickup-No Trip
18	27-3P Alarm
19	SEF Trip
20	External Trip
21	External Close
22	Breaker Opened
23	Breaker Closed
24	Open Trip Contact
25	Recloser Lockout
26	Direct Trip
27	Direct Close

Operation Record Type	
28	MDT Close
29	External Trip and ARC
30	Reclose Initiated
31	CB Failed to Trip
32	CB Failed to Close
33	CB Pops Open
34	CB Pops Closed
35	CB State Unknown
36	CB Stuck Closed
37	Ext. Trip CB Stuck
38	Springs Discharged
40	Manual Trip
41	Manual Close
42	Ground TC Enabled
43	Ground TC Disabled
44	Phase TC Enabled
45	Phase TC Disabled
46	Primary Set Active
47	Alt 1 Set Active
48	Alt 2 Set Active
49	Zone Step
50	Recloser Enabled
51	Recloser Disabled
52	Zone Sequence Enabled
53	Zone Sequence Disabled
54	50P/N-1 Disabled
55	50P/N-2 Disabled
56	50P/N-3 Disabled
57	50P/N-1 Enabled
58	50P/N-2 Enabled
59	50P/N-3 Enabled
60	81S-2 Trip (DPU2000/R)
61	81R-2 Restore (DPU2000/R)
62	81O-1 Overfrequency (DPU2000/R)
63	81O-2 Overfrequency (DPU2000/R)
70	Blown Fuse Alarm
71	OC Trip Counter
72	Accumulated KSI
73	79 Counter 1 Alarm
74	Phase Demand Alarm
75	Neutral Demand Alarm
76	Low PF Alarm
77	High PF Alarm
78	Trip Coil Failure
79	kVAR Demand Alarm
80	79 Counter 2 Alarm
81	Pos kVAR Alarm
82	Neg. kVAR Alarm
83	Load Alarm
84	Cold Load Alarm
85	Pos Watt Alarm 1
86	Pos Watt Alarm 2
87	32P Trip (DPU2000/R)
88	32N Trip (DPU2000/R)
90	Event Capture #1
91	Event Capture #2
92	Waveform Capture
93	BFT Operation (DPU2000/R)

Operation Record Type	
94	RETRIP Operation (DPU2000/R)
95	Ext. BFI Enabled (DPU2000/R)
96	Ext. BFI Disabled (DPU2000/R)
97	BFI Enabled (DPU2000/R)
98	BFI Disabled (DPU2000/R)
100	ROM Failure
101	RAM Failure
102	Self Test Failed
103	EEPROM Failure
104	BATRAM Failure
105	DSP Failure
106	Control Power Fail
107	Editor Access
128	Springs Charged
129	Springs Discharged
130	79S Input Enabled
131	79S Input Disabled
132	79M Input Enabled
133	79M Input Disabled
134	TCM Input Closed
135	TCM Input Opened
136	ALT 1 Input Enabled
137	ALT 1 Input Disabled
138	ALT 2 Input Enabled
139	ALT 2 Input Disabled
140	Ext Trip Enabled
141	Ext Trip Disabled
142	Event Cap 1 Init
143	Event Cap 1 Reset
144	Event Cap 2 Init
145	Event Cap 2 Reset
146	Wave Cap Init
147	Wave Cap Reset
148	Ext Close Enabled
149	Ext Close Disabled
150	52a Closed
151	52a Opened
152	52b Closed
153	52b Opened
154	43a Closed
155	43a Opened
156	46 Unit Enabled
157	46 Unit Disabled
158	67P Unit Enabled (DPU2000/R)
159	67P Unit Disabled (DPU2000/R)
160	67N Unit Enabled (DPU2000/R)
161	67N Unit Disabled (DPU2000/R)
162	ULI1 Input Closed (DPU2000/R)
163	ULI1 Input Opened (DPU2000/R)
164	ULI2 Input Closed (DPU2000/R)
165	ULI2 Input Opened (DPU2000/R)
166	ULI3 Input Closed (DPU2000/R)
167	ULI3 Input Opened (DPU2000/R)
168	ULI4 Input Closed (DPU2000/R)
169	ULI4 Input Opened (DPU2000/R)
170	ULI5 Input Closed (DPU2000/R)
171	ULI5 Input Opened (DPU2000/R)
172	ULI6 Input Closed (DPU2000/R)

Operation Record Type	
173	ULI6 Input Opened (DPU2000/R)
174	ULI7 Input Closed (DPU2000/R)
175	ULI7 Input Opened (DPU2000/R)
176	ULI8 Input Closed (DPU2000/R)
177	ULI8 Input Opened (DPU2000/R)
178	ULI9 Input Closed (DPU2000/R)
179	ULI9 Input Opened (DPU2000/R)
180	CRI Input Closed
181	CRI Input Opened
182	ARC Blocked
183	ARC Enabled
184	TARC Opened
185	SEF Enabled
186	SEF Disabled
187	User Display Input On
188	User Display Input Off
189	25 TC Enabled (DPU2000/R)
190	25 TC Disabled (DPU2000/R)
191	Lines Synced
192	Line Sync Lost
193	CB Slow
194	Local Enabled
195	Local Disabled
196	25 Bypass Enabled (DPU2000/R)
197	25 Bypass Disabled (DPU 2000/R)
198	25 Synch Failed (DPU 2000/R)
199	Catalog Number Update

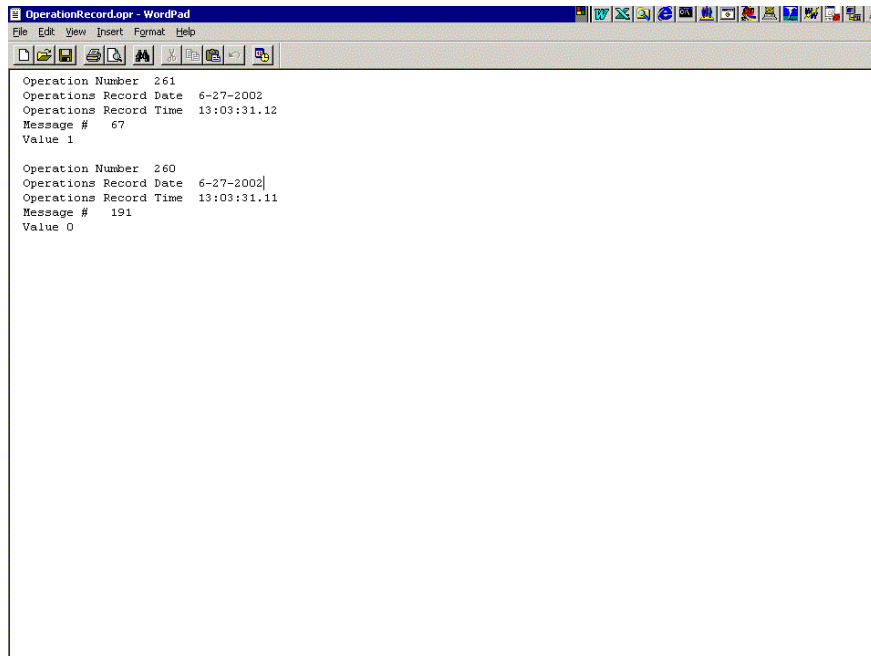

Figure 5-10. Example Text File Illustrating the Operation Record Contents

**Appendix A – Standard 10-Byte Protocol Document for
DPU2000/2000R/1500R**

Revision 9.0

Copyright © 1999 ABB Inc.
 ALL RIGHTS RESERVED

1 Document Revision History

Rev	Date	Initial	Notes
4.00	05/29/96	DAH	ER No. 960045
5.00	04/14/99	DAH	Revised document's format to reflect current ABB documentation format. Changed document name to reflect addition of 1500R to the DPU Series of relays. Modified commands for the DPU1500R Protocol Command Set.
6.00	11/99	CWH	Revised document and added 59G, 67N, and 3V0 enhancements for the DPU2000R 4.10 release .
7.00	04/10/01	KEB	Add 47, 47*, 3ph_59, and 3ph_59* to logical outputs in 3 0 7 Command
8.0	04/29/01	Vab	Added 21P-1/2/3/4 and 21P-1*/2*/3*/4*. Added appendix A for protocol change details for V5.0 DPU2000R.
9.0	07/12/01	Vs	Added C1 – C6 and 9 Targets Alarms for Logical Outputs in Block 6, offset 52 for cmd 3 1 1

1	Document Revision History	59
2	Introduction	63
2.1	Purpose	63
2.2	Scope	63
3	Protocol Translation	63
3.1	Command Message	63
3.2	Data Message	64
4	Transmission and Reception Convention	64
4.1	Simple Commands	65
4.2	Upload Data	65
4.3	Download Data	65
5	Command Set Summary	67
5.1	Transmit Status "N" Commands (3 0 n)	67
5.1.1	Transmit Fast Status (3 0 0)	67
5.1.2	Unit Information (3 0 2)	67
5.1.3	RCVDALL (3 0 3)	68
5.1.4	Unreported Record Status (3 0 4)	68
5.1.5	Reset Alarms/Target LEDs (3 0 5)	68
5.1.6	Reset Max/Min Demand Currents (3 0 6)	68
5.1.7	Show logical Input/Output Status (3 0 7)	68
5.1.7.1	DPU2000 Logical I/O	68
5.1.7.2	DPU2000R Logical I/O	69
5.1.7.3	DPU1500R Logical I/O	69
5.1.7.4	Logical I/O Bit Definitions	69
5.1.8	Reset Relay Status (3 0 8)	72
5.2	Register Data "N" Command (3 1 n)	72
5.2.1	Transmit Register Based Data Set (3 1 1)	72
5.2.1.1	Register Based Communication Definitions	73
5.2.2	Transmit Modbus™ Extended Register Set Command (3 1 2)	83
5.2.3	Receive Modbus™ Extended Register Set Command (3 1 3)	83
5.3	Transmit Buffer "33N" Commands (3 3 n)	84
5.3.1	Transmit Communications Settings (3 3 1)	84
5.3.2	Transmit Counter Settings (3 3 2)	85
5.3.3	Transmit Master Trip Output Assignment (3 3 3)	86
5.3.4	Transmit Breaker Fail Settings (3 3 4)	86
5.4	Transmit Buffer "34N" Commands (3 4 n)	87
5.4.1	Transmit Programmable Input Select and Index (3 4 1)	87
5.4.2	Transmit Programmable Input Negated AND Input (3 4 2)	92
5.4.3	Transmit Programmable Input AND/OR Select (3 4 3)	94
5.4.4	Transmit Programmable User Defined Input Names (3 4 4)	94
5.4.5	Transmit Programmable Output Select (3 4 5)	95
5.4.6	Transmit Programmable Output AND/OR Select (3 4 6)	96
5.4.7	Transmit Programmable Output User Defined Strings (3 4 7)	100
5.4.8	Transmit Relay Settings (3 4 x)	101
5.4.8.1	Standard ANSI Curves for DPU2000 and DPU2000R	101
5.4.8.2	Recloser Curves for DPU2000 and DPU2000R	101
5.4.8.3	IEC Curves for DPU2000R	102
5.4.8.4	ANSI/IEC Curves for DPU1500R	102
5.4.8.5	79-X Select Bit Pattern for DPU2000/2000R/1500R	103
5.4.9	Transmit Configuration Settings (3 4 11)	105
5.4.10	Transmit Counter Settings (3 4 12)	107
5.4.11	Transmit Alarm Settings (3 4 13)	107
5.4.12	Transmit Real Time Clock (3 4 14)	108
5.4.13	Transmit Programmable Output Delays (3 4 15)	108
5.5	Transmit Buffer "35N" Commands (3 5 n)	109
5.5.1	Show Load Metered Data (3 5 1)	109
5.5.2	Show Demand Metered Data (3 5 2)	111
5.5.3	Show Maximum Peak Demand Metered Data (3 5 3)	112

5.5.4	Show Minimum Peak Demand Metered Data (3 5 4)	113
5.5.5	Show Load Metered Data (3 5 5)	114
5.5.6	Show Average Load Current (3 5 6)	114
5.5.7	Show Quick 3-Phase Meter (3 5 7)	114
5.5.8	Send First Fault Record (3 5 8)	114
5.5.9	Send Next Fault Record (3 5 9)	116
5.5.10	Send First Fault Summary Record (3 5 10)	116
5.5.11	Send Next Fault Summary Record (3 5 11)	117
5.5.12	Send First Operations Record (3 5 12)	117
5.5.13	Send Next Operations Record (3 5 13)	121
5.5.14	Breaker Status (Including I/O Status) (3 5 14)	121
5.5.15	Power Fail Data (3 5 15)	122
5.6	Load Profile/Record Commands (3 6 n)	122
5.6.1	Load Profile Settings (3 6 0)	122
5.6.2	Accumulate Load Profile Data (3 6 1)	122
5.6.3	Freeze Load Profile Data (3 6 2)	122
5.6.4	Report Load Profile Data Header (All Data) (3 6 3)	122
5.6.5	Report Next Load Profile Data Block (3 6 4)	123
5.6.6	Retransmit the Last Load Profile Data Block (3 6 5)	124
5.6.7	Report Load Profile Data Header(Last Data) (3 6 6)	124
5.6.8	Oldest Unreported Fault Record (3 6 8)	124
5.6.9	Oldest Unreported Operations Record (3 6 9)	124
5.7	Miscellaneous Commands (3 9 n)	124
5.7.1	Trip Command (3 9 0)	125
5.7.2	CLOSE Command (3 9 1)	125
5.7.3	Energize Output Contact Command (3 9 2)	125
5.7.4	Set/Reset Output Contacts Command (3 9 3)	126
5.7.5	CLOSE Command (3 9 4)	127
5.7.6	Force Physical Input (3 9 5)	127
5.7.7	Force Logical Input (3 9 6)	128
5.7.8	Force Physical Output Contact Command (3 9 7)	129
5.8	Receive Buffer "N" Commands (3 10 n)	130
5.8.1	Receive Communications Settings (3 10 1)	130
5.8.2	Receive Counter Settings (3 10 2)	131
5.8.3	Receive Master Trip Output Assignment (3 10 3)	132
5.8.4	Breaker Failure Settings (3 10 4)	132
5.9	Receive Edit Buffer "N" Commands (3 11 n)	133
5.9.1	Receive Programmable Input Select and Index (3 11 1)	133
5.9.2	Receive Programmable Input Negated AND (3 11 2)	137
5.9.3	Receive Programmable Input AND/OR Select (3 11 3)	138
5.9.4	Receive Programmable Input User Defined Strings (3 11 4)	138
5.9.5	Receive Programmable Output Select (3 11 5)	139
5.9.6	Receive Programmable Output AND/OR/Index (3 11 6)	141
5.9.7	Receive Programmable Output User Defined Names (3 11 7)	145
5.9.8	Receive Relay Settings (3 11 x)	145
5.9.8.1	Standard ANSI Curves for DPU2000 and DPU2000R	145
5.9.8.2	Recloser Curves for DPU2000 and DPU2000R	146
5.9.8.3	IEC Curves for DPU2000R	146
5.9.8.4	ANSI/IEC Curves for DPU1500R	147
5.9.8.5	79-X Select Bit Pattern for DPU2000/2000R/1500R	147
5.9.9	Receive Configuration Settings (3 11 11)	150
5.9.10	Receive Counter Settings (3 11 12)	151
5.9.11	Receive Alarm Settings (3 11 13)	152
5.9.12	Receive Real Time Clock (3 11 14)	153
5.9.13	Receive Programmable Output Delays (3 11 15)	153
5.10	Programmable Curve Commands (3 13 n)	153
5.10.1	Receive Curve Parameters (3 13 1)	154
5.10.2	Receive First Curve Data Set (3 13 2)	154
5.10.3	Receive Next Curve Data Set (3 13 3)	155

5.10.4	Receive Curve Pointer Table (3 13 4)	155
5.10.5	Send Curve Parameters (3 13 5)	156
5.10.6	Send Curve Data Set (3 13 6)	157
5.10.7	Send Curve Pointer Table (3 13 7)	158
5.11	Waveform Capture Commands (3 14 n)	159
5.11.1	Define Waveform Capture Settings (3 14 0)	159
5.11.2	Report Waveform Capture Settings (3 14 1)	160
5.11.3	Arm Waveform Data Accumulation (3 14 2)	161
5.11.4	Disarm Waveform Data Accumulation (3 14 3)	161
5.11.5	Report Waveform Record Data Headers (3 14 4)	161
5.11.6	Fetch First Block of a Record (3 14 5)	162
5.11.7	Fetch Next Block of a Record (3 14 6)	163
5.11.8	Retransmit Last Block of a Record (3 14 7)	163
5.11.9	Fetch Acquisition Status (3 14 8)	163
6	Appendix A – Revision History Detail	164
6.1	DPU2000R version 5.0, Protocol document revisions 7.0 to 8.0	164

2 Introduction

2.1 Purpose

The purpose of this protocol document is to define the valid commands for the DPU Series of relays. The words transmit and receive in each command description, are with respect to the relay.

This DPU Series Protocol Command Set document is intended for ABB personnel and customers.

2.2 Scope

This DPU Series Protocol Command Set document will depict the manner in which a three byte INCOM protocol is translated to a 10 byte RS-232 protocol. This document defines the communication commands required for the following product models: DPU2000, DPU2000R and DPU1500R. The first three characters of the DPU's catalog number identifies the model. For a DPU2000 they are, 484 or 487. For a DPU2000R they are, 587 or 687. For a DPU1500R they are, 577. Features that are specific to only one unit model or variation of that model will be noted throughout this document.

Starting with V5.0 DPU2000R, appendix A lists the protocol changes between box versions.

3 Protocol Translation

The commands are spelt out in a 10 byte RS-232 protocol or a 3 byte INCOM protocol. It will be easy to understand the commands in a 33 bit INCOM context and then translate the protocol to a 10 byte RS-232 protocol. The protocol messages are of two types - command and data.

Command Message (33 bit INCOM)

	S	S	C/D	Inst	Cmd	Subcmd	Address	BCH	S
Bit	1	2	3	4 to 7	8 to 11	12 to 15	16 to 27	28 to 32	33

Figure 2 - Command Message (INCOM)

Data Message (33 bit INCOM)

	S	S	C/D	Data 1	Data 2	Data 3	BCH	S
Bit	1	2	3	4 to 11	12 to 19	20 to 27	28 to 32	33

Figure 3 - Data Message (INCOM)

3.1 Command Message

An INCOM command message can be represented in a 10 byte RS-232 protocol as follows:

Command Message (10 byte RS-232)

	STX	C/D	Inst	Cmd	SCmd	Addr Lo	Addr Mid	Addr Hi	CS Lo	CS Hi
Byte	1	2	3	4	5	6	7	8	9	10

Figure 4 - Command Message (10 byte RS 232)

The address bytes, Addr Lo, Addr Mid, and Addr Hi, are a 3 digit hex address. The checksum is 256 minus the sum of the ASCII characters in bytes 1 to 8. CS Lo is the low byte and CS Hi is the high byte of the checksum.

Example (3 4 1 command with a unit address of 001)

STX	=	hex 02	=	use 2 -->	Start of transmission
C/D	=	hex 31	=	ASCII 1 -->	Command type of message
Inst	=	hex 33	=	ASCII 3 -->	Instruction byte

Cmd	=	hex 34	=	ASCII 4 -->	Command byte
SCmd	=	hex 31	=	ASCII 1 -->	Subcommand byte
Addr Lo	=	hex 31	=	ASCII 1 -->	Unit address low byte
Addr Mid	=	hex 30	=	ASCII 0 -->	Unit address mid byte
Addr Hi	=	hex 30	=	ASCII 0 -->	Unit address high byte
CS Lo	=	hex 34	=	ASCII 4 -->	Checksum low byte
CS Hi	=	hex 46	=	ASCII F -->	Checksum high byte

Checksum = 256 - (STX + C/D + Inst + Cmd + SCmd + Addr Lo + Addr Mid + Addr Hi)
 256 - (2 + 1 + 3 + 4 + 1 + 1 + 0 + 0) = F4

3.2 Data Message

Data Message (10 byte RS-232)

	STX	C/D	D1 Lo	D1 Hi	D2 Lo	D2 Hi	D3 Lo	D3 Hi	CS Lo	CS Hi
Byte	1	2	3	4	5	6	7	8	9	10

An INCOM data message can be represented in a 10 byte RS-232 protocol as follows:

Where D1 Lo is the low nibble of the first data byte and

D1 Hi is the high nibble of the first data byte, D2 Lo is the low nibble of the second data byte and D2 Hi is the high nibble of the second data byte, and D3 Lo is the low nibble of the third data byte and D3 Hi is the high nibble of the third data byte.

The checksum is 256 minus the sum of the ASCII characters in bytes 1 to 8. CS Lo is the low byte and CS Hi is the high byte of the checksum.

Example (3 data bytes, ASCII characters 4, 8, and 7)				
STX	=	hex 2 -->	Start of transmission	
C/D	=	hex 0 -->	Data type of message	
D1 Lo	=	hex 4 -->	Data 1 low byte	
D1 Hi	=	hex 3 -->	Data 1 high byte	
D2 Lo	=	hex 8 -->	Data 2 low byte	
D2 Hi	=	hex 3 -->	Data 2 high byte	
D3 Lo	=	hex 7 -->	Data 3 low byte	
D3 Hi	=	hex 3 -->	Data 3 high byte	
CS Lo	=	hex 2 -->	Checksum low byte	
CS Hi	=	hex E -->	Checksum high byte	

The three data bytes translate to:
 Data 1 = 34 --> ASCII 4
 Data 2 = 38 --> ASCII 8
 Data 3 = 37 --> ASCII 7

Checksum = 256 - (STX + C/D + D1L + D1H + D2L + D2H + D3L + D3H)
 256 - (2 + 0 + 4 + 3 + 8 + 3 + 7 + 3) = E2

4 Transmission and Reception Convention

To acknowledge successful receipt of a message, an ACK is transmitted. The three byte message packet is 0x000013. For an unsuccessful reception, ie. a checksum error or an error in command processing, a NACK is transmitted. The three byte message packet is 0x100013.

The commands for the relay can be categorized into three basic types according to the response that is expected by the master. When a command or data is received, the relay must acknowledge if the reception was successful.

4.1 Simple Commands

A simple command directs the relay to perform specific actions. After the successful completion of these actions, the relay transmits an ACK as seen below.

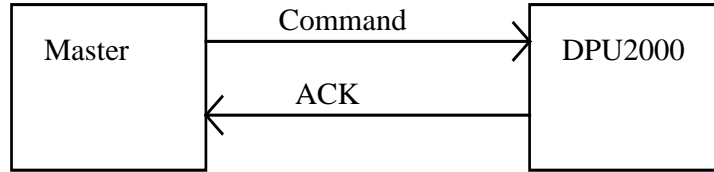

Figure 6 - Simple Command Communication Flow

4.2 Upload Data

This type of command requests the relay to transmit specific data. The proper transmission of this data is the relay acknowledge of this type of command as seen below.

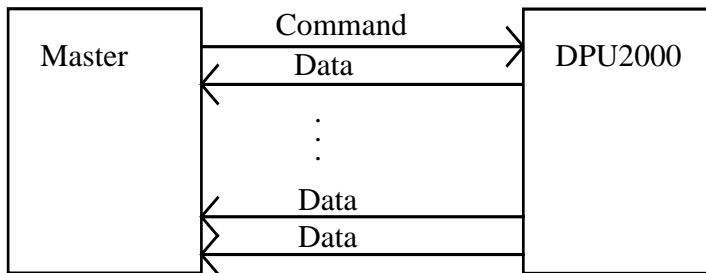

Figure 7 - Upload Data Communication Flow

4.3 Download Data

These commands edit the relay data. The relay responds with an ACK after the successful receipt of each data message packet. This can be seen in the figure below.

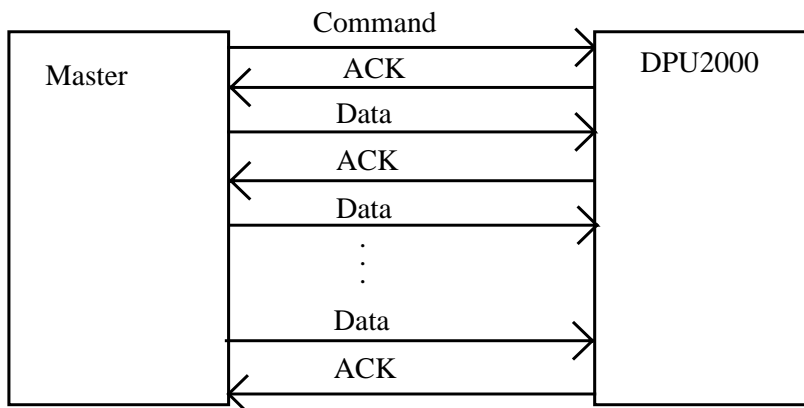

Figure 8 - Download Data Communication Flow

Message Packet Checksum: This checksum is different than the checksum associated with every INCOM message packet. The value of the checksum is contained in a two byte integer and is the summation of all message bytes (1/1 + 1/2 + 1/3 + 2/1 + 2/2 + ...) for the command. The only exception is that the checksum message bytes are not included in the summation.

Example (3 3 1 command): (values are hex equivalent of the ASCII)

1/1 = hex 05	3/1 = hex 44
1/2 = hex 31	3/2 = hex 00
1/3 = hex 04	3/3 = hex 00
2/1 = hex 00	4/1 = hex 00
2/2 = hex 01	4/2 = hex 00 <-- checksum high byte
2/3 = hex 44	4/3 = hex C3 <-- checksum low byte

5 Command Set Summary

<u>Inst</u>	<u>Cmd</u>	<u>Subcmd</u>	<u>Definition</u>
3	0	n	Status Commands
3	1	n	Register Data Acquisition Command
3	2	n	
3	3	n	Transmit Settings Commands
3	4	n	Transmit Settings Commands
3	5	n	Transmit Meter/Record Commands
3	6	n	Load Profile Commands
3	7	n	
3	8	n	
3	9	n	Relay Commands
3	10	n	Receive Edit Buffer Commands
3	11	n	Receive Edit Buffer Commands
3	12	n	
3	13	n	Programmable Curve Commands
3	14	n	Waveform Capture Commands
3	15	n	Reserved for Factory

5.1 Transmit Status "N" Commands (3 0 n)

<u>N</u>	<u>Definition</u>
0	Transmit Fast Status
1	Reserved
2	Unit Information
3	Reserved for RCVDALL
4	Unreported Record Status
5	Reset Alarms/Target LEDs
6	Reset Max/Min Demand Currents
7	Logical Input/Output Status
8	Reset Relay Status Flag

5.1.1 Transmit Fast Status (3 0 0)

This command will cause the relay to respond with one data message with the format shown below:

```
byte 3           |byte 2           |byte 1
ST2 ST1 L T4 T3 T2 T1 T0|P5 P4 P3 P2 P1 P0 A3 A2 | A1 A0 D5 D4 D3 D2 D1 D0
```

D5 D4 D3 D2 D1 D0 => Division Code. RTD division code is 5 (000101)

A3 A2 A1 A0 => A0 - If this bit is set, one or more Unreported Operations have occurred.

A1 => Reserved

A2, A3 => Reserved

P5 P4 P3 P2 P1 P0 => Product ID. (DPU2000 series = 001110)

T2 T1 T0 => Reserved

T4 T3 => Reserved

L => Local Operator interface action. (Future implementation)

ST2 ST1 => Corporate standard status bits. (Future implementation)

5.1.2 Unit Information (3 0 2)

This command will cause the relay to transmit data messages containing catalog number and the software version.

1/1-5/3	Catalog Number (15 characters)
6/1	CPU Software Version high byte (*100)
6/2	CPU Software Version low byte (bit 0-14 version number *100, bit 15 1=non released software version)
6/3	DSP Software Version (*10)
7/1	Front Panel Software Version (*10)

7/2	Rear Communication Software version (*10)
7/3	Serial Number most significant high byte
8/1	Serial Number most significant low byte
8/2	Serial Number least significant high byte
8/3	Serial Number least significant low byte

5.1.3 RCVDALL (3 0 3)

- Reserved -

5.1.4 Unreported Record Status (3 0 4)

This command will respond with the number of unacknowledged operation and fault records.

To mark the record as being reported, a 3 6 8 command will retrieve the oldest unreported fault record and decrement the unreported fault record counter by one.

Likewise, a 3 6 9 command will retrieve the oldest unreported operations record and decrement the unreported fault record counter by one.

<u>Msg byte</u>	<u>Definition</u>
1/1	Relay Status (see command 3 4 1, msg 1/1)
1/2	Command + Subcommand = 0x04
1/3	Total Number of Messages = 4
2/1	Unreported Fault Record Count byte
2/2	Unreported Operation Record Count byte
2/3	Spare
3/1	Spare
3/2	Spare
3/3	Spare
4/1	Spare
4/2	Spare
4/3	Spare

5.1.5 Reset Alarms/Target LEDs (3 0 5)

The targets, alarms and relay status flag (see command 3 4 1 msg 2/1) will be reset on the relay. After the relay receives this command it will transmit an ACK/NACK based on the completion of the command.

5.1.6 Reset Max/Min Demand Currents (3 0 6)

This command will reset the Max/Min demand current values along with their time tags. After the relay receives this command it will transmit an ACK/NACK based on the completion of the command.

5.1.7 Show logical Input/Ouput Status (3 0 7)

This command displays the binary value of the logical input and output table for the present state of the unit.

Bit = 0, Input Disabled/Output Not Energized.

Bit = 1, Input Enabled/Output Energized.

Outputs denoted with '*' are sealed in until cleared.

5.1.7.1 DPU2000 Logical I/O

DPU2000 Logical Inputs Include: "TCM", "GRD", "PH3", "50-1", "50-2", "50-3", "ALT1", "ALT2", "ZSC", "SCC", "79S", "79M", "OPEN", "CLOSE", "ECI1", "ECI2", "WCI", "46", "67P", "67N", "ULI1", "ULI2", "ULI3", "ULI4", "ULI5", "ULI6", "ULI7", "ULI8", "ULI9", "CRI", "UDI".

DPU2000 Logical Outputs Include: "TRIP", "CLOSE", "ALARM", "BFA", "TCFA", "79LOA", "TCC", "PUA", "51P", "51N", "46", "50P-1", "50N-1", "50P-2", "50N-2", "50P-3", "50N-3", "PATA", "PBTA", "PCTA", "67P", "67N", "81S-1", "81R-1", "81O-1", "27-1P", "59", "79DA", "79CA1", "OCTC", "KSI", "PDA", "NDA", "PVAra", "NVAra", "LOADA", "50-1D", "LPFA", "HPFA", "ZSC", "50-2D", "BFUA", "STCA", "PH3-D", "GRD-D", "27-3P", "VarDA", "79CA2",

"TRIPA", "TRIPB", "TRIPC", "27-1P*", "46*", "50P-1*", "50N-1*", "50P-2*", "50N-2*", "50P-3*", "50N-3*", "51P*", "51N*", "59*", "67P*", "67N*", "81S-1*", "81R-1*", "81O-1*", "27-3P*", "TRIPA*", "TRIPB*", "TRIPC*", "ULO1", "ULO2", "ULO3", "ULO4", "ULO5", "ULO6", "ULO7", "ULO8", "ULO9", "81O-2", "81S-2", "81R-2", "81O-2*", "81S-2*", "81R-2*", "CLTA", "PWatt1", "PWatt2", "79CA1*", "79CA2*", "BFA*".

5.1.7.2 DPU2000R Logical I/O

DPU2000R Logical Inputs Include: "52A", "52B", "43A", "TCM", "GRD", "PH3", "50-1", "50-2", "50-3", "ALT1", "ALT2", "ZSC", "SCC", "79S", "79M", "OPEN", "CLOSE", "ECI1", "ECI2", "WCI", "46", "67P", "67N", "ULI1", "ULI2", "ULI3", "ULI4", "ULI5", "ULI6", "ULI7", "ULI8", "ULI9", "CRI", "ARCI", "TARC", "SEF" (*Sensitive Earth Model*), "EXTBF", "BFI", "UDI", "25"(*Synch Check Model*), "25By"(*Synch Check Model*). The following logical inputs are available in CPU versions greater than 1.92: "LOCAL", "TGT", "SIA". The following logical inputs are available in CPU version greater than 4.02 (2.01 for PTH): "LIS1", "LIS2", "LIS3", "LIS4", "LIS5", "LIS6", "LIS7", "LIS8", "LIR1", "LIR2", "LIR3", "LIR4", "LIR5", "LIR6", "LIR7", "LIR8", "TR_SET", "TR_RST".

DPU2000R Logical Outputs Include: "TRIP", "CLOSE", "ALARM", "BFA", "TCFA", "79LOA", "TCC", "PUA", "51P", "51N", "46", "50P-1", "50N-1", "50P-2", "50N-2", "50P-3", "50N-3", "PATA", "PBTA", "PCTA", "67P", "67N", "81S-1", "81R-1", "81O-1", "27-1P", "59", "79DA", "79CA1", "OCTC", "KSI", "PDA", "NDA", "PVArA", "NVArA", "LOADA", "50-1D", "LPFA", "HPFA", "ZSC", "50-2D", "BFUA", "STCA", "PH3-D", "GRD-D", "32PA", "32NA", "27-3P", "VarDA", "79CA2", "TRIPA", "TRIPB", "TRIPC", "27-1P*", "46*", "50P-1*", "50N-1*", "50P-2*", "50N-2*", "50P-3*", "50N-3*", "51P*", "51N*", "59*", "67P*", "67N*", "81S-1*", "81R-1*", "81O-1*", "27-3P*", "TRIPA*", "TRIPB*", "TRIPC*", "ULO1", "ULO2", "ULO3", "ULO4", "ULO5", "ULO6", "ULO7", "ULO8", "ULO9", "81O-2", "81S-2", "81R-2", "81O-2*", "81S-2*", "81R-2*", "CLTA", /* V1.40 */ "PWatt1", "PWatt2", "79CA1*", "79CA2*".

The following were added to CPU V1.60: "SEF"(*Sensitive Earth Model*), "SEF"(*Sensitive Earth Model*), "BZA", "BFT", "ReTrp", "BFT*", "ReTrp*".

The following were added to CPU V1.80: "32P-2", "32N-2", "32P-2*", "32N-2*", "BFA*".

The following were added to CPU V1.93: "25"(*Synch Check Model*), "25"(*Synch Check Model*), "SBA".

The following were added to CPU V3.20: "79V" and "RClIn". The following were added to CPU V4.10 (2.10 for PTH): "59G", "59G*", "LO1", "LO2", "LO3", "LO4", "LO5", "LO6", "LO7", "LO8", "TR_ON", "TR_OFF", "TR_TAG".

The following were added to CPU V5.0: "59-3p", "59-3p*", "47", "47*", "21P-1", "21P-1*", "21P-2", "21P-2*", "21P-3", "21P-3*", "21P-4", "21P-4*".

5.1.7.3 DPU1500R Logical I/O

DPU1500R Logical Inputs Include: "52A", "52B", "43A", "TCM", "GRD", "PH3", "50-1", "50-2", "50-3", "ALT1", "ALT2", "ZSC", "SCC", "79S", "79M", "OPEN", "CLOSE", "ECI1", "ECI2", "WCI", "46", "CRI", "ARCI", "TARC", "SEF" (*Sensitive Earth Model*), "UDI", "LOCAL", "TGT", "SIA".

DPU1500R Logical Outputs Include: "TRIP", "CLOSE", "ALARM", "BFA", "TCFA", "79LOA", "TCC", "PUA", "51P", "51N", "46", "50P-1", "50N-1", "50P-2", "50N-2", "50P-3", "50N-3", "PATA", "PBTA", "PCTA", "27-1P", "79DA", "79CA1", "OCTC", "KSI", "PDA", "NDA", "PVArA", "NVArA", "LOADA", "50-1D", "LPFA", "HPFA", "ZSC", "50-2D", "BFUA", "STCA", "PH3-D", "GRD-D", "27-3P", "VarDA", "79CA2", "TRIPA", "TRIPB", "TRIPC", "27-1P*", "46*", "50P-1*", "50N-1*", "50P-2*", "50N-2*", "50P-3*", "50N-3*", "51P*", "51N*", "27-3P*", "TRIPA*", "TRIPB*", "TRIPC*", "CLTA", "PWatt1", "PWatt2", "79CA1*", "79CA2*", "SEF"(*Sensitive Earth Model*), "SEF"(*Sensitive Earth Model*), "BZA", "BFA*", "SBA", "79V" and "RClIn".

5.1.7.4 Logical I/O Bit Definitions

<u>Byte-Bit</u>	<u>Output</u>	<u>Input</u>	<u>Byte-Bit</u>	<u>Output</u>	<u>Input</u>
1-7	TRIP	52a	2-7	50N2	TCM
1-6	CLOSE	52b	2-6	50P3	50-1
1-5	ALARM	43a	2-5	50N3	50-2
1-4	27	PH3	2-4	51P	50-3
1-3	46	GRD	2-3	51N	ALT1
1-2	50P1	SCC	2-2	59	ALT2
1-1	50N1	79S	2-1	67P	ECI1
1-0	50P2	79M	2-0	67N	ECI2

DPU 2000R UCA TECHNICAL GUIDE

<u>Byte-Bit</u>	<u>Output</u>	<u>Input</u>	<u>Byte-Bit</u>	<u>Output</u>	<u>Input</u>
3-7	81S-1	WCI	4-7	PUA	ULI2
3-6	81R-1	ZSC	4-6	79LOA	ULI3
3-5	PATA	OPEN	4-5	BFA	ULI4
3-4	PBTA	CLOSE	4-4	PPDA	ULI5
3-3	PCTA	46	4-3	NPDA	ULI6
3-2	TCFA	67P	4-2	BFUA	ULI7
3-1	TCC	67N	4-1	KSI	ULI8
3-0	79DA	ULI1	4-0	79CA-1	ULI9
<u>Byte-Bit</u>	<u>Output</u>	<u>Input</u>	<u>Byte-Bit</u>	<u>Output</u>	<u>Input</u>
5-7	HPFA	CRI	6-7	GRD-D	25By
5-6	LPFA	ARCI	6-6	32PA	LOCAL
5-5	OCTC	TARC	6-5	32NA	TGT
5-4	50-1D	SEF	6-4	27-3P	SIA
5-3	50-2D	EXTBFI	6-3	VarDA	LIS1
5-2	STC	BFI	6-2	79CA-2	LIS2
5-1	ZSC	UDI	6-1	TRIPA	LIS3
5-0	PH3-D	25	6-0	TRIPB	LIS4
<u>Byte-Bit</u>	<u>Output</u>	<u>Input</u>	<u>Byte-Bit</u>	<u>Output</u>	<u>Input</u>
7-7	TRIPC	LIS5	8-7	50N3*	LIR5
7-6	27*	LIS6	8-6	51P*	LIR6
7-5	46*	LIS7	8-5	51N*	LIR7
7-4	50P1*	LIS8	8-4	59*	LIR8
7-3	50N1*	LIR1	8-3	67P*	TR_SET
7-2	50P2*	LIR2	8-2	67N*	TR_RST
7-1	50N2*	LIR3	8-1	81S-1*	
7-0	50P3*	LIR4	8-0	81R-1*	
<u>Byte-Bit</u>	<u>Output</u>	<u>Input</u>	<u>Byte-Bit</u>	<u>Output</u>	<u>Input</u>
9-7	81O-1*		10-7	ULO4	
9-6	27-3P*		10-6	ULO5	
9-5	TRIPA*		10-5	ULO6	
9-4	TRIPB*		10-4	ULO7	
9-3	TRIPC*		10-3	ULO8	
9-2	ULO1		10-2	ULO9	
9-1	ULO2		10-1	PVArA	
9-0	ULO3		10-0	NVArA	
<u>Byte-Bit</u>	<u>Output</u>	<u>Input</u>	<u>Byte-Bit</u>	<u>Output</u>	<u>Input</u>
11-7	LOADA		12-7	CLTA	
11-6	81O-1		12-6	PWatt1	
11-5	81O-2		12-5	PWatt2	
11-4	81S-2		12-4	79CA1*	
11-3	81R-2		12-3	79CA2*	
11-2	81O-2*		12-2	SEF*	
11-1	81S-2*		12-1	SEF	
11-0	81R-2*		12-0	BZA	
<u>Byte-Bit</u>	<u>Output</u>	<u>Input</u>	<u>Byte-Bit</u>	<u>Output</u>	<u>Input</u>
13-7	BFT		14-7	BFA*	
13-6	RETRIP		14-6	25*	
13-5	BFT*		14-5	25	
13-4	RETRIP*		14-4	SBA	
13-3	32P-2		14-3	79V	
13-2	32N-2		14-2	RClin	
13-1	32P-2*		14-1	59G	
13-0	32N-2*		14-0	59G*	

<u>Byte-Bit</u>	<u>Output</u>	<u>Input</u>	<u>Byte-Bit</u>	<u>Output</u>	<u>Input</u>
15-7	LO1		16-7	TR_ON	
15-6	LO2		16-6	TR_OFF	
15-5	LO3		16-5	TR_TAG	
15-4	LO4		16-4	59-3ph	
15-3	LO5		16-3	59-3ph*	
15-2	LO6		16-2	47	
15-1	LO7		16-1	47*	
15-0	LO8		16-0	spare	
<u>Byte-Bit</u>	<u>Output</u>	<u>Input</u>	<u>Byte-Bit</u>	<u>Output^{note1}</u>	<u>Input</u>
17-7	21P-1	not	18-7		not
17-6	21P-1*	applicable,	18-6		applicable,
17-5	21P-2	no more	18-5		no more
17-4	21P-2*	logical input	18-4		logical input
17-3	21P-3	bytes are	18-3		bytes are
17-2	21P-3*	available. ^{note 1}	18-2		available. ^{note 1}
17-1	21P-4		18-1		
17-0	21P-4*		18-0		

NOTE: SEF and SEF* are available in DPU2000R and DPU1500R Sensitive Earth models only.

Note 1: Do NOT use this command for future expansion of logical outputs or logical inputs. Use the appropriate 3-1-1 command in place of 3-0-7. 3-0-7 will eventually be replaced by command 3-1-1.

<u>Msg byte</u>	<u>Definition</u>
1/1	Relay Status (see command 3 4 1, msg 1/1)
1/2	Command + Subcommand = 0x07
1/3	Total Number of Messages = 13
2/1	Logical Output byte1
2/2	Logical Output byte2
2/3	Logical Output byte3
3/1	Logical Output byte4
3/2	Logical Output byte5
3/3	Logical Output byte6
4/1	Logical Output byte7
4/2	Logical Output byte8
4/3	Logical Output byte9
5/1	Logical Output byte10
5/2	Logical Output byte11
5/3	Logical Output byte12
6/1	Logical Output byte13
6/2	Logical Output byte14
6/3	Logical Output byte15
7/1	Logical Output byte16
7/2	Logical Input byte1
7/3	Logical Input byte2
8/1	Logical Input byte3
8/2	Logical Input byte4
8/3	Logical Input byte5
9/1	Logical Input byte6
9/2	Logical Input byte7
9/3	Logical Input byte8
10/1	Logical Input byte9
10/2	Logical Input byte10
10/3	Logical Input byte11
11/1	Logical Input byte12
11/2	Logical Input byte13

11/3	Logical Input byte14
12/1	Logical Input byte15
12/2	Logical Input byte16
12/3	Logical Output byte 17
13/1	Logical Output byte 18
13/2	Checksum High Byte
13/3	Checksum Low Byte

5.1.8 Reset Relay Status (3 0 8)

The relay status flag (see command 3 4 1 msg 2/1) will be reset on the relay. After the relay receives this command it will transmit an ACK/NACK based on the completion of the command.

5.2 Register Data "N" Command (3 1 n)

<u>N</u>	<u>Definition</u>
0	Reserved for repeat 3 1 n
1	Register Based Communication Command
2	Transmit Modbus™ Extended Register Set Command
3	Receive Modbus™ Extended Register Set Command

5.2.1 Transmit Register Based Data Set (3 1 1)

NOTE: The register based command, 3-1-1, is available in DPU2000R and DPU1500R, all block and offset register data refers to DPU2000R and DPU1500R models.

<u>Data Byte</u>	<u>Definition</u>	
1/1	Block Number	(0-255)
1/2	Offset Number	(0-255)
1/3	Number of Bytes to Retrieve (Num Bytes)	(1-132)

<u>Msg Byte</u>	<u>Definition</u>
1/1	Relay Status Byte Bit 7: Control Power Cycled Bit 6: New Fault Recorded Bit 5: Alternate 2 Settings Active Bit 4: Alternate 1 Settings Active Bit 3: Remote Edit Disable Bit 2: Local Settings Changed Bit 1: Contact Input Chnaged Bit 0: Selftest Status
1/2	Command + Subcommand = 11
1/3	Total Number of Messages (TotalMsg = 1+(Num Bytes/3))
2/1	Data Byte Block Number, Offset Number
2/2	Data Byte Block Number, Offset Number + 1
2/3	Data Byte Block Number, Offset Number + 2
.	.
.	.
.	.
TotalMsg/1	Data Byte Block Number, Offset Number + NumBytes - 3
TotalMsg/2	Data Byte Block Number, Offset Number + NumBytes - 2
TotalMsg/3	Data Byte Block Number, Offset Number + NumBytes - 1

<u>Data Type Definitions</u>	<u>Value Ranges</u>
Unsigned Byte	(0 to 255)
Signed Byte	(-128 to 127)
Unsigned Short	(0 to 65,535)
Signed Short	(-32,768 to 32,767)
Unsigned Long	(0 to 4,294,967,295)
Signed Long	(-2,147,483,648 to 2,147,483,647)

Note: Data Byte Order follows the Low Address-High Byte, High Address -Low Byte Convention.

5.2.1.1 Register Based Communication Definitions

5.2.1.1.1 BLK 0: SYSTEM STATUS/CONFIGURATION BLOCK

<u>Block Offset</u>	<u>Data Size</u>	<u>Scale</u>	<u>Description</u>
Offset 0:	Unsigned Word		Relay Status Bit 15-11: Spare Bit 10: New Minimum DemandValue Bit 9: New Peak Demand Value Bit 8: New Operation Recorded Bit 7: Control Power Cycled Bit 6: New Fault Recorded Bit 5: Alternate 2 Settings Active Bit 4: Alternate 1 Settings Active Bit 3: Remote Edit Disable Bit 2: Local Settings Changed Bit 1: Contact Input Changed Bit 0: Selftest Status
Offset 2:	Unsigned Long		Diagnostic Status Flag Bit 31-16: Spare Bit 15: DSP COP FAILURE Bit 14: DSP +5V FAILURE Bit 13: DSP +/-15V FAILURE Bit 12: DSP +/-5V FAILURE Bit 11: DSP ADC FAILURE Bit 10: DSP EXT RAM FAILURE Bit 9: DSP INT RAM FAILURE Bit 8: DSP ROM FAILURE Bit 7: Spare Bit 6: Spare Bit 5: Spare Bit 4: Spare Bit 3: CPU EEPROM FAILURE Bit 2: CPU NVRAM FAILURE Bit 1: CPU EPROM FAILURE Bit 0: CPU RAM FAILURE
Offset 6:	Unsigned Word		Relay Configuration Bit 15-2: Spare Bit 2: 0=V(line-neutral), 1=V(line-line) Bit 1: 0=kWhr/kVarhr, 1=MWhr/MVarhr Bit 0: 0= Wye PT, 1=Delta PT
Offset 8:20	Char String		Catalog Number
Offset 28:	Unsigned Short	100	CPU Software Version Number
Offset 30:	Unsigned Short	10	Analog/DSP Software Version Number
Offset 32:	Unsigned Short	10	Front Panel Controller Software Version Number
Offset 34:	Unsigned Short	10	Auxillary Communication Software Version Number
Offset 36:	Unsigned Long	1	Serial Number
Offset 40:	18 Char String		Unit Name

5.2.1.1.2 BLK 1: RMS LOAD CURRENT/ANGULAR VALUES BLOCK

<u>Block Offset</u>	<u>Data Size</u>	<u>Scale</u>	<u>Description</u>
Offset 0:	Unsigned Word	1	Load Current-A
Offset 2:	Unsigned Word	1	Load Current-A Angle
Offset 4:	Unsigned Word	1	Load Current-B
Offset 6:	Unsigned Word	1	Load Current-B Angle
Offset 8:	Unsigned Word	1	Load Current-C

Offset 10:	Unsigned Word	1	Load Current-C Angle
Offset 12:	Unsigned Word	1	Load Current-N
Offset 14:	Unsigned Word	1	Load Current-N Angle
Offset 16:	Unsigned Long	1	Voltage VAN
Offset 20:	Unsigned Word	1	Voltage VAN Angle
Offset 22:	Unsigned Long	1	Voltage VBN
Offset 26:	Unsigned Word	1	Voltage VBN Angle
Offset 28:	Unsigned Long	1	Voltage VCN
Offset 32:	Unsigned Word	1	Voltage VCN Angle
Offset 34:	Unsigned Long	1	Voltage VAB
Offset 38:	Unsigned Word	1	Voltage VAB Angle
Offset 40:	Unsigned Long	1	Voltage VBC
Offset 44:	Unsigned Word	1	Voltage VBC Angle
Offset 46:	Unsigned Long	1	Voltage VCA
Offset 50:	Unsigned Word	1	Voltage VCA Angle
Offset 52:	Signed Long	1	kWatts A
Offset 56:	Signed Long	1	kWatts B
Offset 60:	Signed Long	1	kWatts C
Offset 64:	Signed Long	1	3 Phase kWatts
Offset 68:	Signed Long	1	kVars A
Offset 72:	Signed Long	1	kVars B
Offset 76:	Signed Long	1	kVars C
Offset 80:	Signed Long	1	3 Phase kVars
Offset 84:	Signed Long	1	kWatt Hours A
Offset 88:	Signed Long	1	kWatt Hours B
Offset 92:	Signed Long	1	kWatt Hours C
Offset 96:	Signed Long	1	kWatt Hours 3 Phase
Offset 100:	Signed Long	1	kVar Hours A
Offset 104:	Signed Long	1	kVar Hours B
Offset 108:	Signed Long	1	kVar Hours C
Offset 112:	Signed Long	1	kVar Hours 3 Phase
Offset 116:	Unsigned Word	1	Load Current Zero Sequence
Offset 118:	Unsigned Word	1	Load Current Zero Sequence Angle
Offset 120:	Unsigned Word	1	Load Current Positive Sequence
Offset 122:	Unsigned Word	1	Load Current Positive Sequence Angle 1
Offset 124:	Unsigned Word	1	Load Current Negative Sequence
Offset 126:	Unsigned Word	1	Load Current Negative Sequence Angle
Offset 128:	Unsigned Long	1	Voltage 1 Magnitude
Offset 132:	Unsigned Word	1	Voltage 1 Angle
Offset 134:	Unsigned Long	1	Voltage 2 Magnitude
Offset 138:	Unsigned Word	1	Voltage 2 Angle
Offset 140:	Unsigned Word	100	System Frequency
Offset 142:	Unsigned Word		Power Factor Bit 15-9: Not used Bit 8: 0=Positive, 1=Negative Bit 7: 0=Leading, 1=Lagging Bit 6-0: Power Factor Value (x100)
Offset 144:	Unsigned Long	1	Current Sens Earth Mag
Offset 148:	Unsigned Word	1	Current Sens Earth Angle
Offset 150:	Unsigned Long	1	3V0/Vbus Mag
Offset 154:	Unsigned Word	1	3V0/Vbus Ang
Offset 156:	Signed Word	100	Power Factor
Offset 158:	Unsigned Word		Power Factor Status Bits 15-1: Not used Bit 0: 0=Leading, 1=Lagging
Offset 159:	Unsigned Word	1	Reserved
Offset 160:	Unsigned Word	1	Reserved
Offset 161:	Unsigned Word	1	3V0 Mag (calculated)

Offset 162: Unsigned Word 1 3V0 Ang (calculated)

5.2.1.1.3 BLK 2: RMS DEMAND CURRENT/REAL and REACTIVE POWER VALUES BLOCK

<u>Block Offset</u>	<u>Data Size</u>	<u>Scale</u>	<u>Description</u>
Offset 0:	Unsigned Short	1	Demand Current-A
Offset 2:	Unsigned Short	1	Demand Current-B
Offset 4:	Unsigned Short	1	Demand Current-C
Offset 6:	Unsigned Short	1	Demand Current-N
Offset 8:	Signed Long	1	Demand kWatts-A
Offset 12:	Signed Long	1	Demand kWatts-B
Offset 16:	Signed Long	1	Demand kWatts-C
Offset 20:	Signed Long	1	3 Phase Demand Watts
Offset 24:	Signed Long	1	Demand kVars-A
Offset 28:	Signed Long	1	Demand kVars-B
Offset 32:	Signed Long	1	Demand kVars-C
Offset 36:	Signed Long	1	3 Phase Demand Vars

5.2.1.1.4 BLK 3: RMS PEAK DEMAND CURRENT/REAL and REACTIVE POWER VALUES and TIME STAMPS BLOCK

<u>Block Offset</u>	<u>Data Size</u>	<u>Scale</u>	<u>Description</u>
Offset 0:	Unsigned Word	1	Peak Demand Current-A
Offset 2:	Unsigned Byte		Peak Demand Current-A Year
Offset 3:	Unsigned Byte		Peak Demand Current-A Month
Offset 4:	Unsigned Byte		Peak Demand Current-A Day
Offset 5:	Unsigned Byte		Peak Demand Current-A Hour
Offset 6:	Unsigned Byte		Peak Demand Current-A Minute
Offset 7:	Unsigned Byte		Spare
Offset 8:	Unsigned Word	1	Peak Demand Current-B
Offset 10:	Unsigned Byte		Peak Demand Current-B Year
Offset 11:	Unsigned Byte		Peak Demand Current-B Month
Offset 12:	Unsigned Byte		Peak Demand Current-B Day
Offset 13:	Unsigned Byte		Peak Demand Current-B Hour
Offset 14:	Unsigned Byte		Peak Demand Current-B Minute
Offset 15:	Unsigned Byte		Spare
Offset 16:	Unsigned Word	1	Peak Demand Current-C
Offset 18:	Unsigned Byte		Peak Demand Current-C Year
Offset 19:	Unsigned Byte		Peak Demand Current-C Month
Offset 20:	Unsigned Byte		Peak Demand Current-C Day
Offset 21:	Unsigned Byte		Peak Demand Current-C Hour
Offset 22:	Unsigned Byte		Peak Demand Current-C Minute
Offset 23:	Unsigned Byte		Spare
Offset 24:	Unsigned Word	1	Peak Demand Current-N
Offset 26:	Unsigned Byte		Peak Demand Current-N Year
Offset 27:	Unsigned Byte		Peak Demand Current-N Month
Offset 28:	Unsigned Byte		Peak Demand Current-N Day
Offset 29:	Unsigned Byte		Peak Demand Current-N Hour
Offset 30:	Unsigned Byte		Peak Demand Current-N Minute
Offset 31:	Unsigned Byte		Spare
Offset 32:	Signed Long	1	Peak Demand KWatts-A
Offset 36:	Unsigned Byte		Peak Demand KWatts-A Year
Offset 37:	Unsigned Byte		Peak Demand KWatts-A Month
Offset 38:	Unsigned Byte		Peak Demand KWatts-A Day
Offset 39:	Unsigned Byte		Peak Demand KWatts-A Hour
Offset 40:	Unsigned Byte		Peak Demand KWatts-A Minute
Offset 41:	Unsigned Byte		Spare

Offset 42:	Signed Long	1	Peak Demand KWatts-B
Offset 46:	Unsigned Byte		Peak Demand KWatts-B Year
Offset 47:	Unsigned Byte		Peak Demand KWatts-B Month
Offset 48:	Unsigned Byte		Peak Demand KWatts-B Day
Offset 49:	Unsigned Byte		Peak Demand KWatts-B Hour
Offset 50:	Unsigned Byte		Peak Demand KWatts-B Minute
Offset 51:	Unsigned Byte		Spare
Offset 52:	Signed Long	1	Peak Demand KWatts-C
Offset 56:	Unsigned Byte		Peak Demand KWatts-C Year
Offset 57:	Unsigned Byte		Peak Demand KWatts-C Month
Offset 58:	Unsigned Byte		Peak Demand KWatts-C Day
Offset 59:	Unsigned Byte		Peak Demand KWatts-C Hour
Offset 60:	Unsigned Byte		Peak Demand KWatts-C Minute
Offset 61:	Unsigned Byte		Spare
Offset 62:	Signed Long	1	3 Phase Peak Demand KWatts
Offset 66:	Unsigned Byte		3 Phase Peak Demand KWatts Year
Offset 67:	Unsigned Byte		3 Phase Peak Demand KWatts Month
Offset 68:	Unsigned Byte		3 Phase Peak Demand KWatts Day
Offset 69:	Unsigned Byte		3 Phase Peak Demand KWatts Hour
Offset 70:	Unsigned Byte		3 Phase Peak Demand KWatts Minute
Offset 71:	Unsigned Byte		Spare
Offset 72:	Signed Long	1	Peak Demand KVars-A
Offset 76:	Unsigned Byte		Peak Demand KVars-A Year
Offset 77:	Unsigned Byte		Peak Demand KVars-A Month
Offset 78:	Unsigned Byte		Peak Demand KVars-A Day
Offset 79:	Unsigned Byte		Peak Demand KVars-A Hour
Offset 80:	Unsigned Byte		Peak Demand KVars-A Minute
Offset 81:	Unsigned Byte		Spare
Offset 82:	Signed Long	1	Peak Demand KVars-B
Offset 86:	Unsigned Byte		Peak Demand KVars-B Year
Offset 87:	Unsigned Byte		Peak Demand KVars-B Month
Offset 88:	Unsigned Byte		Peak Demand KVars-B Day
Offset 89:	Unsigned Byte		Peak Demand KVars-B Hour
Offset 90:	Unsigned Byte		Peak Demand KVars-B Minute
Offset 91:	Unsigned Byte		Spare
Offset 92:	Signed Long	1	Peak Demand KVars-C
Offset 96:	Unsigned Byte		Peak Demand KVars-C Year
Offset 97:	Unsigned Byte		Peak Demand KVars-C Month
Offset 98:	Unsigned Byte		Peak Demand KVars-C Day
Offset 99:	Unsigned Byte		Peak Demand KVars-C Hour
Offset 100:	Unsigned Byte		Peak Demand KVars-C Minute
Offset 101:	Unsigned Byte		Spare
Offset 102:	Signed Long	1	3 Phase Peak Demand KVars
Offset 106:	Unsigned Byte		3 Phase Peak Demand KVars Year
Offset 107:	Unsigned Byte		3 Phase Peak Demand KVars Month
Offset 108:	Unsigned Byte		3 Phase Peak Demand KVars Day
Offset 109:	Unsigned Byte		3 Phase Peak Demand KVars Hour
Offset 110:	Unsigned Byte		3 Phase Peak Demand KVars Minute
Offset 111:	Unsigned Byte		Spare

5.2.1.1.5 BLK 4: RMS MINIMUM DEMAND CURRENT/REAL and REACTIVE POWER VALUES and TIME STAMPS BLOCK

<u>Block Offset</u>	<u>Data Size</u>	<u>Scale</u>	<u>Description</u>
Offset 0:	Unsigned Word	1	Minimum Demand Current-A
Offset 2:	Unsigned Byte		Minimum Demand Current-A Year
Offset 3:	Unsigned Byte		Minimum Demand Current-A Month
Offset 4:	Unsigned Byte		Minimum Demand Current-A Day

Offset 5:	Unsigned Byte		Minimum Demand Current-A Hour
Offset 6:	Unsigned Byte		Minimum Demand Current-A Minute
Offset 7:	Unsigned Byte		Spare
Offset 8:	Unsigned Word	1	Minimum Demand Current-B
Offset 10:	Unsigned Byte		Minimum Demand Current-B Year
Offset 11:	Unsigned Byte		Minimum Demand Current-B Month
Offset 12:	Unsigned Byte		Minimum Demand Current-B Day
Offset 13:	Unsigned Byte		Minimum Demand Current-B Hour
Offset 14:	Unsigned Byte		Minimum Demand Current-B Minute
Offset 15:	Unsigned Byte		Spare
Offset 16:	Unsigned Word	1	Minimum Demand Current-C
Offset 18:	Unsigned Byte		Minimum Demand Current-C Year
Offset 19:	Unsigned Byte		Minimum Demand Current-C Month
Offset 20:	Unsigned Byte		Minimum Demand Current-C Day
Offset 21:	Unsigned Byte		Minimum Demand Current-C Hour
Offset 22:	Unsigned Byte		Minimum Demand Current-C Minute
Offset 23:	Unsigned Byte		Spare
Offset 24:	Unsigned Word	1	Minimum Demand Current-N
Offset 26:	Unsigned Byte		Minimum Demand Current-N Year
Offset 27:	Unsigned Byte		Minimum Demand Current-N Month
Offset 28:	Unsigned Byte		Minimum Demand Current-N Day
Offset 29:	Unsigned Byte		Minimum Demand Current-N Hour
Offset 30:	Unsigned Byte		Minimum Demand Current-N Minute
Offset 31:	Unsigned Byte		Spare
Offset 32:	Signed Long	1	Minimum Demand KWatts-A
Offset 36:	Unsigned Byte		Minimum Demand KWatts-A Year
Offset 37:	Unsigned Byte		Minimum Demand KWatts-A Month
Offset 38:	Unsigned Byte		Minimum Demand KWatts-A Day
Offset 39:	Unsigned Byte		Minimum Demand KWatts-A Hour
Offset 40:	Unsigned Byte		Minimum Demand KWatts-A Minute
Offset 41:	Unsigned Byte		Spare
Offset 42:	Signed Long	1	Minimum Demand KWatts-B
Offset 46:	Unsigned Byte		Minimum Demand KWatts-B Year
Offset 47:	Unsigned Byte		Minimum Demand KWatts-B Month
Offset 48:	Unsigned Byte		Minimum Demand KWatts-B Day
Offset 49:	Unsigned Byte		Minimum Demand KWatts-B Hour
Offset 50:	Unsigned Byte		Minimum Demand KWatts-B Minute
Offset 51:	Unsigned Byte		Spare
Offset 52:	Signed Long	1	Minimum Demand KWatts-C
Offset 56:	Unsigned Byte		Minimum Demand KWatts-C Year
Offset 57:	Unsigned Byte		Minimum Demand KWatts-C Month
Offset 58:	Unsigned Byte		Minimum Demand KWatts-C Day
Offset 59:	Unsigned Byte		Minimum Demand KWatts-C Hour
Offset 60:	Unsigned Byte		Minimum Demand KWatts-C Minute
Offset 61:	Unsigned Byte		Spare
Offset 62:	Signed Long	1	3 Phase Minimum Demand KWatts
Offset 66:	Unsigned Byte		3 Phase Minimum Demand KWatts Year
Offset 67:	Unsigned Byte		3 Phase Minimum Demand KWatts Month
Offset 68:	Unsigned Byte		3 Phase Minimum Demand KWatts Day
Offset 69:	Unsigned Byte		3 Phase Minimum Demand KWatts Hour
Offset 70:	Unsigned Byte		3 Phase Minimum Demand KWatts Minute
Offset 71:	Unsigned Byte		Spare
Offset 72:	Signed Long	1	Minimum Demand KVars-A
Offset 76:	Unsigned Byte		Minimum Demand KVars-A Year
Offset 77:	Unsigned Byte		Minimum Demand KVars-A Month
Offset 78:	Unsigned Byte		Minimum Demand KVars-A Day
Offset 79:	Unsigned Byte		Minimum Demand KVars-A Hour
Offset 80:	Unsigned Byte		Minimum Demand KVars-A Minute
Offset 81:	Unsigned Byte		Spare

Offset 82:	Signed Long	1	Minimum Demand KVars-B
Offset 86:	Unsigned Byte		Minimum Demand KVars-B Year
Offset 87:	Unsigned Byte		Minimum Demand KVars-B Month
Offset 88:	Unsigned Byte		Minimum Demand KVars-B Day
Offset 89:	Unsigned Byte		Minimum Demand KVars-B Hour
Offset 90:	Unsigned Byte		Minimum Demand KVars-B Minute
Offset 91:	Unsigned Byte		Spare
Offset 92:	Signed Long	1	Minimum Demand KVars-C
Offset 96:	Unsigned Byte		Minimum Demand KVars-C Year
Offset 97:	Unsigned Byte		Minimum Demand KVars-C Month
Offset 98:	Unsigned Byte		Minimum Demand KVars-C Day
Offset 99:	Unsigned Byte		Minimum Demand KVars-C Hour
Offset 100:	Unsigned Byte		Minimum Demand KVars-C Minute
Offset 101:	Unsigned Byte		Spare
Offset 102:	Signed Long	1	3 Phase Minimum Demand KVars
Offset 106:	Unsigned Byte		3 Phase Minimum Demand KVars Year
Offset 107:	Unsigned Byte		3 Phase Minimum Demand KVars Month
Offset 108:	Unsigned Byte		3 Phase Minimum Demand KVars Day
Offset 109:	Unsigned Byte		3 Phase Minimum Demand KVars Hour
Offset 110:	Unsigned Byte		3 Phase Minimum Demand KVars Minute
Offset 111:	Unsigned Byte		Spare

5.2.1.1.6 BLK 5: COUNTERS BLOCK

Overcurrent Trip Counters A, B, C, and N are available in DPU2000R with Recloser Curve Software option, catalog numbers XXXXXXXX-XXX2X or XXXXXXXX-XXX3X.

<u>Block Offset</u>	<u>Data Size</u>	<u>Scale</u>	<u>Description</u>
Offset 0:	Unsigned Short	1	Operations Counter
Offset 2:	Unsigned Short	1	Fault Counter
Offset 4:	Unsigned Short	1	Sum of Fault Currents, A
Offset 6:	Unsigned Short	1	Sum of Fault Currents, B
Offset 8:	Unsigned Short	1	Sum of Fault Currents, C
Offset 10:	Unsigned Short	1	Overcurrent Trip Counter
Offset 12:	Unsigned Short	1	Breaker Operations Counter
Offset 14:	Unsigned Short	1	Recloser Counter 1
Offset 16:	Unsigned Short	1	Stage 1 Reclose Counter
Offset 18:	Unsigned Short	1	Stage 2 Reclose Counter
Offset 20:	Unsigned Short	1	Stage 3 Reclose Counter
Offset 22:	Unsigned Short	1	Stage 4 Reclose Counter
Offset 24:	Unsigned Short	1	Recloser Counter 2
Offset 26:	Unsigned Short	1	Overcurrent Trip Counter A
Offset 28:	Unsigned Short	1	Overcurrent Trip Counter B
Offset 30:	Unsigned Short	1	Overcurrent Trip Counter C
Offset 32:	Unsigned Short	1	Overcurrent Trip Counter D

5.2.1.1.7 BLK 6: PHYSICAL and LOGICAL INPUT/OUTPUT BLOCK

<u>Block Offset</u>	<u>Data Size</u>	<u>Description</u>
Offset 0:	Unsigned Long	Logical Output 0-31
		Bit 31: TRIP Bit 15: 81S (2000R)
		Bit 30: CLOSE Bit 14: 81R (2000R)
		Bit 29: ALARM Bit 13: PATA
		Bit 28: 27-1P Bit 12: PBTA
		Bit 27: 46 Bit 11: PCTA
		Bit 26: 50P-1 Bit 10: TCFA
		Bit 25: 50N-1 Bit 9: TCC
		Bit 24: 50P-2 Bit 8: 79DA
		Bit 23: 50N-2 Bit 7: PUA

		Bit 22: 50P-3	Bit 6: 79LOA
		Bit 21: 50N-3	Bit 5: BFA
		Bit 20: 51P	Bit 4: PPDA
		Bit 19: 51N	Bit 3: NPDA
		Bit 18: 59 (2000R)	Bit 2: BFUA
		Bit 17: 67P (2000R)	Bit 1: KSI
		Bit 16: 67N (2000R)	Bit 0: 79CA
Offset 4:	Unsigned Long	Logical Output 32-63	
		Bit 31: HPFA	Bit 15: TRIPC
		Bit 30: LPFA	Bit 14: 27-1P*
		Bit 29: OCTC	Bit 13: 46*
		Bit 28: 50-1D	Bit 12: 50P-1*
		Bit 27: 50-2D	Bit 11: 50N-1*
		Bit 26: STC	Bit 10: 50P-2*
		Bit 25: ZSC	Bit 9: 50N-2*
		Bit 24: PH3-D	Bit 8: 50P-3*
		Bit 23: GRD-D	Bit 7: 50N-3*
		Bit 22: 32PA (2000R)	Bit 6: 51P*
		Bit 21: 32NA (2000R)	Bit 5: 51N*
		Bit 20: 27-3P	Bit 4: 59* (2000R)
		Bit 19: VarDA	Bit 3: 67P* (2000R)
		Bit 18: 79CA-2	Bit 2: 67N* (2000R)
		Bit 17: TRIPA	Bit 1: 81S1* (2000R)
		Bit 16: TRIPB	Bit 0: 81R1* (2000R)
Offset 8:	Unsigned Long	Logical Output 64-95	
		Bit 31: 81O1* (2000R)	Bit 15: LOADA
		Bit 30: 27-3P*	Bit 14: 81O1 (2000R)
		Bit 29: TRIPA*	Bit 13: 81O2 (2000R)
		Bit 28: TRIPB*	Bit 12: 81S2 (2000R)
		Bit 27: TRIPC*	Bit 11: 81R2 (2000R)
		Bit 26: ULO1 (2000R)	Bit 10: 81O2 (2000R)
		Bit 25: ULO2 (2000R)	Bit 9: 81S2 (2000R)
		Bit 24: ULO3 (2000R)	Bit 8: 81R2 (2000R)
		Bit 23: ULO4 (2000R)	Bit 7: CLTA
		Bit 22: ULO5 (2000R)	Bit 6: Watt1
		Bit 21: ULO6 (2000R)	Bit 5: Watt2
		Bit 20: ULO7 (2000R)	Bit 4: 79CA*
		Bit 19: ULO8 (2000R)	Bit 3: 79CA-2*
		Bit 18: ULO9 (2000R)	Bit 2: SEF*
		Bit 17: PVArA	Bit 1: SEF
		Bit 16: NVArA	Bit 0: BZA w/out SEF
Offset 12:	Unsigned Long	Logical Output 96-127	
		Bit 31: BFT (2000R)	Bit 15: LO1
		Bit 30: ReTrip (2000R)	Bit 14: LO2
		Bit 29: BFT* (2000R)	Bit 13: LO3
		Bit 28: ReTrip* (2000R)	Bit 12: LO4
		Bit 27: 32P-2 (2000R)	Bit 11: LO5
		Bit 26: 32N-2 (2000R)	Bit 10: LO6
		Bit 25: 32P-2* (2000R)	Bit 9: LO7
		Bit 24: 32N-2* (2000R)	Bit 8: LO8
		Bit 23: BFA*	Bit 7: TR_ON
		Bit 22: 25* (2000R)	Bit 6: TR_OFF
		Bit 21: 25 (2000R)	Bit 5: TR_TAG
		Bit 20: SBA	Bit 4: 59-3p (DPU2000R)
		Bit 19: 79V	Bit 3: 59-3p* (DPU2000R)
		Bit 18: RClIn	Bit 2: 47 (DPU2000R)
		Bit 17: 59G	Bit 1: 47* (DPU2000R)
		Bit 16: 59G*	Bit 0: spare
Offset 16:	Unsigned Long	Logical Input 0-31	

		Bit 31: 52a	Bit 15: WCI
		Bit 30: 52b	Bit 14: ZSC
		Bit 29: 43a	Bit 13: OPEN
		Bit 28: PH3	Bit 12: CLOSE
		Bit 27: GRD	Bit 11: 46
		Bit 26: SCC	Bit 10: 67P (2000R)
		Bit 25: 79s	Bit 9: 67N (2000R)
		Bit 24: 79m	Bit 8: ULI1 (2000R)
		Bit 23: TCM	Bit 7: ULI2 (2000R)
		Bit 22: 50-1	Bit 6: ULI3 (2000R)
		Bit 21: 50-2	Bit 5: ULI4 (2000R)
		Bit 20: 50-3	Bit 4: ULI5 (2000R)
		Bit 19: ALT1	Bit 3: ULI6 (2000R)
		Bit 18: ALT2	Bit 2: ULI7 (2000R)
		Bit 17: ECI1	Bit 1: ULI8 (2000R)
		Bit 16: ECI2	Bit 0: ULI9 (2000R)
Offset 20:	Unsigned Long	Logical Input 32-63	
		Bit 31: CRI	Bit 15: LIS5(2000R)
		Bit 30: ARCI	Bit 14: LIS6(2000R)
		Bit 29: TARC	Bit 13: LIS7(2000R)
		Bit 28: SEF TC	Bit 12: LIS8(2000R)
		Bit 27: EXTBFI (2000R)	Bit 11: LIR1(2000R)
		Bit 26: BFI (2000R)	Bit 10: LIR2(2000R)
		Bit 25: UDI	Bit 9: LIR3(2000R)
		Bit 24: 25 (2000R)	Bit 8: LIR4(2000R)
		Bit 23: 25By (2000R)	Bit 7: LIR5(2000R)
		Bit 22: LOCAL	Bit 6: LIR6(2000R)
		Bit 21: TGT	Bit 5: LIR7(2000R)
		Bit 20: SIA	Bit 4: LIR8(2000R)
		Bit 19: LIS1(2000R)	Bit 3: TR_SET(2000R)
		Bit 18: LIS2(2000R)	Bit 2: TR_RST(2000R)
		Bit 17: LIS3(2000R)	Bit 1:
		Bit 16: LIS4(2000R)	Bit 0:
Offset 24:	Unsigned Long	Logical Input 64-95 (Reserved)	
Offset 28:	Unsigned Long	Logical Input 96-127 (Reserved)	
Offset 32:	Unsigned Short	Physical Output	
		Bit 15: Reserved	Bit 7: OUT6
		Bit 14: Reserved	Bit 6: OUT5
		Bit 13: Reserved	Bit 5: OUT4
		Bit 12: Reserved	Bit 4: OUT3
		Bit 11: Reserved	Bit 3: OUT2
		Bit 10: Reserved	Bit 2: OUT1
		Bit 9: Reserved	Bit 1: CLOSE (Reserved)
		Bit 8: Reserved	Bit 0: TRIP
Offset 34:	Unsigned Short	Physical Input	
		Bit 15: Reserved	Bit 7: IN5
		Bit 14: Reserved	Bit 6: IN4
		Bit 13: Reserved	Bit 5: IN3
		Bit 12: Reserved	Bit 4: IN2
		Bit 11: Reserved	Bit 3: IN1
		Bit 10: IN8 (2000R)	Bit 2: Reserved
		IN6 (1500R)	
		Bit 9: IN7 (2000R)	Bit 1: Reserved
		Bit 8: IN6 (2000R)	Bit 0: Reserved
Offset 36:	Unsigned Short	Forced Physical Inputs Normal State Mask	
		0=Normal state, 1=Normal state override or return to Normal state	
		Bit 15: Reserved	Bit 7: IN5
		Bit 14: Reserved	Bit 6: IN4
		Bit 13: Reserved	Bit 5: IN3

		Bit 12: Reserved	Bit 4: IN2
		Bit 11: Reserved	Bit 3: IN1
		Bit 10: IN8 (2000R)	Bit 2: Reserved
		IN6 (1500R)	
		Bit 9: IN7 (2000R)	Bit 1: Reserved
		Bit 8: IN6 (2000R)	Bit 0: Reserved
Offset 38:	Unsigned Short	Forced Physical Inputs Forcing State Mask	
		If Forced Physical Inputs Normal State Mask bit is set then	
		0=Forcing Reset state or Open, 1=Forcing Set state or Close	
		Bit 15: Reserved	Bit 7: IN5
		Bit 14: Reserved	Bit 6: IN4
		Bit 13: Reserved	Bit 5: IN3
		Bit 12: Reserved	Bit 4: IN2
		Bit 11: Reserved	Bit 3: IN1
		Bit 10: IN8 (2000R)	Bit 2: Reserved
		IN6 (1500R)	
		Bit 9: IN7 (2000R)	Bit 1: Reserved
		Bit 8: IN6 (2000R)	Bit 0: Reserved

Offsets 36 and 38, two 16 bit words, Forced Physical Inputs Normal State mask and Forced Physical Inputs Forcing State mask, indicate which inputs to force and the state to which they are being forced. If the bit specific to an input is reset in the Normal State mask then all input operations for that input will proceed according to normal logical conditions. If the Normal State mask bit specific to an input is set then all input operations for that input will be ignored and the Forcing State mask will be utilized to force the input condition indicated by the Forcing State mask.

Offset 40:	Unsigned Short	Forced Physical Outputs Normal State Mask	
		0=Normal state, 1=Normal state override or return to Normal state	
		Bit 15: Spare	Bit 7: OUT6
		Bit 14: Spare	Bit 6: OUT5
		Bit 13: Spare	Bit 5: OUT4
		Bit 12: Spare	Bit 4: OUT3
		Bit 11: Spare	Bit 3: OUT2
		Bit 10: Spare	Bit 2: OUT1
		Bit 9: Reserved	Bit 1: CLOSE (Reserved)
		Bit 8: Reserved	Bit 0: TRIP
Offset 42:	Unsigned Short	Forced Physical Outputs Forcing State Mask	
		If Forced Physical Outputs Normal State Mask bit is set then	
		0=Forcing Reset state or De-Assert, 1=Forcing Set state or Assert	
		Bit 15: Spare	Bit 7: OUT6
		Bit 14: Spare	Bit 6: OUT5
		Bit 13: Spare	Bit 5: OUT4
		Bit 12: Spare	Bit 4: OUT3
		Bit 11: Spare	Bit 3: OUT2
		Bit 10: Spare	Bit 2: OUT1
		Bit 9: Reserved	Bit 1: CLOSE (Reserved)
		Bit 8: Reserved	Bit 0: TRIP

Offsets 40 and 42, two 16 bit words, Forced Physical Outputs Normal State mask and Forced Physical Outputs Forcing State mask, indicate which outputs to force and the state to which they are being forced. If the bit specific to an output is reset in the Normal State mask then all output operations for that output will proceed according to normal logical conditions. If the Normal State mask bit specific to an output is set then all output operations for that output will be ignored and the Forcing State mask will be utilized to force the output condition indicated by the Forcing State mask.

Offset 44:	Unsigned Long	Forced Logical Inputs Normal State Mask	
		0=Normal state, 1=Normal state override or return to Normal state	
		Bit 31: FLI31	Bit 15: FLI15
		Bit 30: FLI30	Bit 14: FLI14
		Bit 29: FLI29	Bit 13: FLI13
		Bit 28: FLI28	Bit 12: FLI12
		Bit 27: FLI27	Bit 11: FLI11

		Bit 26: FLI26	Bit 10: FLI10
		Bit 25: FLI25	Bit 9: FLI09
		Bit 24: FLI24	Bit 8: FLI08
		Bit 23: FLI23	Bit 7: FLI07
		Bit 22: FLI22	Bit 6: FLI06
		Bit 21: FLI21	Bit 5: FLI05
		Bit 20: FLI20	Bit 4: FLI04
		Bit 19: FLI19	Bit 3: FLI03
		Bit 18: FLI18	Bit 2: FLI02
		Bit 17: FLI17	Bit 1: FLI01
		Bit 16: FLI16	Bit 0: FLI00
Offset 48:	Unsigned Long	Forced Logical Inputs Forcing State Mask	
		If Forced Logical Inputs Normal State Mask bit is set then	
		0=Forcing Reset state or Open, 1=Forcing Set state or Close	
		Bit 31: FLI31	Bit 15: FLI15
		Bit 30: FLI30	Bit 14: FLI14
		Bit 29: FLI29	Bit 13: FLI13
		Bit 28: FLI28	Bit 12: FLI12
		Bit 27: FLI27	Bit 11: FLI11
		Bit 26: FLI26	Bit 10: FLI10
		Bit 25: FLI25	Bit 9: FLI09
		Bit 24: FLI24	Bit 8: FLI08
		Bit 23: FLI23	Bit 7: FLI07
		Bit 22: FLI22	Bit 6: FLI06
		Bit 21: FLI21	Bit 5: FLI05
		Bit 20: FLI20	Bit 4: FLI04
		Bit 19: FLI19	Bit 3: FLI03
		Bit 18: FLI18	Bit 2: FLI02
		Bit 17: FLI17	Bit 1: FLI01
		Bit 16: FLI16	Bit 0: FLI00

Offsets 44 and 48, four 32 bit words, the Forced Logical Inputs Normal State mask and Forced Logical Inputs Forcing State mask, indicate which inputs to force and the state to which they are being forced. If the bit specific to an input is reset in the Normal State masks then all input operations for that input will proceed according to normal logical conditions. If the Normal State mask bit specific to an input is set in the Normal State masks then all input operations for that input will be ignored and the Forcing State mask will be utilized to force the input condition indicated by the Forcing State mask.

Offset 52:	Unsigned Long	Logical Output 128 – 159 (DPU2000R)	
		Bit 31: 21P-1	Bit 15: TimeTA
		Bit 30: 21P-1*	Bit 14: InstTA
		Bit 29: 21P-2	Bit 13: NegSeqTA
		Bit 28: 21P-2*	Bit 12: FreqTA
		Bit 27: 21P-3	Bit 11: DirTA
		Bit 26: 21P-3*	Bit 10: VoltTA
		Bit 25: 21P-4	Bit 9: DistTA
		Bit 24: 21P-4*	Bit 8:
		Bit 23: C1	Bit 7:
		Bit 22: C2	Bit 6:
		Bit 21: C3	Bit 5:
		Bit 20: C4	Bit 4:
		Bit 19: C5	Bit 3:
		Bit 18: C6	Bit 2:
		Bit 17: TripTA	Bit 1:
		Bit 16: NTA	Bit 0:
Offset 52:	Unsigned Long	Logical Output 160 – 191 (DPU2000R)	
		Bit 31:	Bit 15:
		Bit 30:	Bit 14:
		Bit 29:	Bit 13:
		Bit 28:	Bit 12:

Bit 27:	Bit 11:
Bit 26:	Bit 10:
Bit 25:	Bit 9:
Bit 24:	Bit 8:
Bit 23:	Bit 7:
Bit 22:	Bit 6:
Bit 21:	Bit 5:
Bit 20:	Bit 4:
Bit 19:	Bit 3:
Bit 18:	Bit 2:
Bit 17:	Bit 1:
Bit 16:	Bit 0:

5.2.2 Transmit Modbus™ Extended Register Set Command (3 1 2)

NOTE: The Modbus™ register based command, 3-1-2, is available in DPU2000R series, CPU V1.80 and above and DPU1500R. See Modbus/Modbus Plus Protocol Document for 6X Register Definitions.

<u>Data Byte</u>	<u>Definition</u>
1/1	Address High Byte (Use 6XXXX-60000)
1/2	Address Low Byte
1/3	Number of WORDS (2 byte quantities) to Retrieve (1-65)

<u>Msg Byte</u>	<u>Definition</u>
1/1	Relay Status Byte <div style="margin-left: 20px;"> Bit 7: Control Power Cycled Bit 6: New Fault Recorded Bit 5: Alternate 2 Settings Active Bit 4: Alternate 1 Settings Active Bit 3: Remote Edit Disable Bit 2: Local Settings Changed Bit 1: Contact Input Chnaged Bit 0: Selftest Status </div>
1/2	Command + Subcommand = 12
1/3	Total Number of Messages
2/1	Data Word 0 High Byte
2/2	Data Word 0 Low Byte
2/3	Data Word 1 High Byte
3/1	Data Word 1 Low Byte
.	.
.	.
.	.
TotalMsg/1	Data Word n Low Byte (or could be spare used to fill out last message)
TotalMsg/2	Checksum High Byte
TotalMsg/3	Checksum Low Byte

5.2.3 Receive Modbus™ Extended Register Set Command (3 1 3)

NOTE: The Modbus™ register based command, 3-1-2, is available in DPU2000R series, CPU V1.80 and above and DPU1500R. See Modbus/Modbus Plus Protocol Document for 6X Register Definitions.

<u>Data Byte</u>	<u>Definition</u>
1/1	Address High Byte (Use 6XXXX-60000)
1/2	Address Low Byte
1/3	Number of WORDS (2 byte quantities) to Write (1-65)
2/1	Data Word 0 High Byte
2/2	Data Word 0 Low Byte
2/3	Data Word 1 High Byte
3/1	Data Word 1 Low Byte
.	.
.	.

TotalMsg/1	Data Word n Low Byte (or could be spare used to fill out last message)
TotalMsg/2	Checksum High Byte
TotalMsg/3	Checksum Low Byte

5.3 Transmit Buffer "33N" Commands (3 3 n)

<u>N</u>	<u>Definition</u>
0	Reserved for repeat 3 3 n
1	Communications Settings
2	Counter Settings
3	Master Trip Output Assignment
4	Breaker Fail Settings

5.3.1 Transmit Communications Settings (3 3 1)

Low byte consists of bits 0 through 7.

High byte consists of bits 8 through 15.

Port configuration byte

bit 0-3 = port baud rate

where 0 = 300, 1 = 1200, 2 = 2400, 3 = 4800, 4 = 9600, 5 = 19200, 6 = 38400

bit 4-5 = parity (0=None, 1=Odd, 2=Even)

bit 6 = number of data bits (0=seven,1=eight)

bit 7 = number of stop bits (0=one,1=two)

Valid Frame Combinations: EVEN 7 1, ODD 7 1, NONE 8 1, EVEN 8 1, ODD 8 1, NONE 8 2, NONE 7 2

<u>Msg byte</u>	<u>Definition</u>
1/1	Relay Status (see command 3 4 1, msg 1/1)
1/2	Command + Subcommand = 0x31
1/3	Total Number of Messages = 9
2/1	Unit Address high byte
2/2	Unit Address low byte
2/3	Front Panel RS 232 configuration byte
3/1	Rear Panel RS 232 or INCOM configuration byte
3/2	Rear Panel RS 485 configuration byte
3/3	Rear Panel IRIG byte
	0=Disable; 1=Enable-cc, time stamp HH:MM:SS.cc;
	2=Enable-mmm, time stamp HH:MM:SS.mmm
4/1	Spare
4/2	Spare
4/3	Aux Port Parameter 1 byte (0-255)
5/1	Aux Port Parameter 2 byte (0-255)
5/2	Aux Port Parameter 3 byte (0-255)
5/3	Aux Port Parameter 4 byte (0-255)
6/1	Aux Port Parameter 5 byte (0-255)
6/2	Aux Port Parameter 6 byte (0-255)
6/3	Aux Port Parameter 7 byte (0-255)
7/1	Aux Port Parameter 8 byte (0-255)
7/2	Aux Port Parameter 9 byte (0-255)
7/3	Aux Port Parameter 10 byte (0-255)
8/1	Aux Port Parameter Mode byte (0-255)
	Bit 0: Par Mode 1 (0=Disable, 1=Enable)
	Bit 1: Par Mode 2 (0=Disable, 1=Enable)
	Bit 2: Par Mode 3 (0=Disable, 1=Enable)
	Bit 3: Par Mode 4 (0=Disable, 1=Enable)
	Bit 4: Par Mode 5 (0=Disable, 1=Enable)
	Bit 5: Par Mode 6 (0=Disable, 1=Enable)
	Bit 6: Par Mode 7 (0=Disable, 1=Enable)
	Bit 7: Par Mode 8 (0=Disable, 1=Enable)

8/2	Spare
8/3	Spare
9/1	Spare
9/2	Checksum high byte
9/3	Checksum low byte

5.3.2 Transmit Counter Settings (3 3 2)

NOTE: Overcurrent Trip Counters A, B, C, and N are available with Recloser Curve Software option, catalog numbers XXXXXXXXX-XXX2X or XXXXXXXXX-XXX3X. In DPU2000 series, CPU V1.41 or higher is required for the Recloser Curve Software option.

Low byte consists of bits 0 through 7.
 High byte consists of bits 8 through 15.

<u>Msg byte</u>	<u>Definition</u>
1/1	Relay Status (see command 3 4 1, msg 1/1)
1/2	Command + Subcommand = 0x32
1/3	Total Number of Messages = 15
2/1	KSI Sum A Counter high byte (0-9999)
2/2	KSI Sum A Counter low byte
2/3	KSI Sum B Counter high byte (0-9999)
3/1	KSI Sum B Counter low byte
3/2	KSI Sum C Counter high byte (0-9999)
3/3	KSI Sum C Counter low byte
4/1	Over Current Trip Counter high byte (0-9999)
4/2	Over Current Trip Counter low byte
4/3	Breaker Operations Counter high byte (0-9999)
5/1	Breaker Operations Counter low byte
5/2	Reclose Counter 1 high byte (0-9999)
5/3	Reclose Counter 1 low byte
6/1	1st Reclose Counter high byte (0-9999)
6/2	1st Reclose Counter low byte
6/3	2nd Reclose Counter high byte (0-9999)
7/1	2nd Reclose Counter low byte
7/2	3rd Reclose Counter high byte (0-9999)
7/3	3rd Reclose Counter low byte
8/1	4th Reclose Counter high byte (0-9999)
8/2	4th Reclose Counter low byte
8/3	Reclose Counter 2 high byte (0-9999)
9/1	Reclose Counter 2 low byte
9/2	Overcurrent Trip A Counter high byte (0-9999), (DPU2000/R)
9/3	Overcurrent Trip A Counter low byte
10/1	Overcurrent Trip B Counter high byte (0-9999) , (DPU2000/R)
10/2	Overcurrent Trip B Counter low byte
10/3	Overcurrent Trip C Counter high byte (0-9999) , (DPU2000/R)
11/1	Overcurrent Trip C Counter low byte
11/2	Overcurrent Trip N Counter high byte (0-9999) , (DPU2000/R)
11/3	Overcurrent Trip N Counter low byte
12/1	SPARE
12/2	SPARE
12/3	SPARE
13/1	SPARE
13/2	SPARE
13/3	SPARE
14/1	SPARE
14/2	SPARE
14/3	SPARE
15/1	SPARE
15/2	Checksum high byte

15/3 Checksum low byte

5.3.3 Transmit Master Trip Output Assignment (3 3 3)

NOTE: In DPU2000 series, CPU V1.70 or higher is required.

<u>Msg/Byte</u>	<u>Definition</u>
1/1	Relay Status (see command 3 4 1, msg 1/1)
1/2	Command + Subcommand = 0x33
1/3	Total Number of Messages = 5
2/1	Master Trip Assignment, Byte 1
	Bit 0: SPARE
	Bit 1: SPARE
	Bit 2: SPARE
	Bit 3: SPARE
	Bit 4: SPARE
	Bit 5: SPARE
	Bit 6: SPARE
	Bit 7: SPARE
2/2	Master Trip Assignment, Byte 2
	Bit 0: SPARE
	Bit 1: SPARE
	Bit 2: SPARE
	Bit 3: SPARE
	Bit 4: SPARE
	Bit 5: SPARE
	Bit 6: SPARE
	Bit 7: SPARE
2/3	Master Trip Assignment, Byte 3
	Bit 0: 67P (DPU2000 and DPU2000R)
	Bit 1: 67N (DPU2000 and DPU2000R)
	Bit 2: 46
	Bit 3: SPARE
	Bit 4: SPARE
	Bit 5: SPARE
	Bit 6: SPARE
	Bit 7: SPARE
3/1	Master Trip Assignment, Byte 4
	Bit 0: 50N-1
	Bit 1: 50N-2
	Bit 2: 50N-3
	Bit 3: 51N
	Bit 4: 50P-1
	Bit 5: 50P-2
	Bit 6: 50P-3
	Bit 7: 51P
3/2	Spare
3/3	Spare
4/1	Spare
4/2	Spare
4/3	Spare
5/1	Spare
5/2	Checksum, high byte
5/3	Checksum, low byte

5.3.4 Transmit Breaker Fail Settings (3 3 4)

NOTE: In DPU2000 series, CPU V1.70 or higher is required. This command is NOT available in the DPU1500R series.

<u>Msg/Byte</u>	<u>Definition</u>
1/1	Relay Status (see command 3 4 1, msg 1/1)

1/2	Command + Subcommand = 0x34
1/3	Total Number of Messages = 7
2/1	Enable (1=ON, 0=OFF)
2/2	BFT Pickup Time Delay (high byte) (0.00 to 10.00 sec. in 0.01 sec. steps)
2/3	BFT Pickup Time Delay (low byte)
3/1	BFT Drop Time Delay (0.0 to 10.0 cycles in 0.25 steps)
3/2	BFT Starters
	Bit 0: External input
	Bit 1: Phase Level Detector
	Bit 2: Neutral Level Detector
3/3	ReTrip Pickup Time Delay (high byte) (0.00 to 10.00 sec. in 0.01 sec. steps)
4/1	ReTrip Pickup Time Delay (low byte)
4/2	ReTrip Drop Time Delay (0.0 to 10.0 cycles in 0.25 steps)
4/3	ReTrip Starters
	Bit 0: External input
	Bit 1: Phase Level Detector
	Bit 2: Neutral Level Detector
5/1	Phase Level Detector Pickup (5 to 100% of 51P in 5% steps)
5/2	Neutral Level Detector Pickup (5 to 100% of 51N in 5% steps)
5/3	Spare
6/1	Spare
6/2	Spare
6/3	Spare
7/1	Spare
7/2	Checksum, high byte
7/3	Checksum, low byte

5.4 Transmit Buffer "34N" Commands (3 4 n)

<u>N</u>	<u>Definition</u>
0	Reserved for repeat 3 4 n
1	Programmable Input Select and Index Tables
2	Programmable Input Negated AND Table
3	Programmable Input AND/OR Table
4	Programmable Input User Defined Input Names
5	Programmable Output Select Table
6	Programmable Output AND/OR Table
7	Programmable Output User Defined Output Strings
8	Primary Relay Settings
9	Alternate 1 Relay Settings
10	Alternate 2 Relay Settings
11	Configuration Settings
12	Counter Settings
13	Alarm Settings
14	Real Time Clock
15	Programmable Output Delays

5.4.1 Transmit Programmable Input Select and Index (3 4 1)

Bit Position:	0	1	2	3	4	5	6	7	8	9	10	11	12	13	14	15
DPU2000:	IN3	IN4	IN9	IN2	IN10	43A	52B	52A	IN1	IN11	IN8	IN7	IN6	IN5	IN13	IN12
DPU2000R:	IN3	IN4	FB1	IN2	FB2	FB3	FB4	FB5	IN1	FB6	IN8	IN7	IN6	IN5	FB7	FB8
DPU1500R:	IN3	IN4	N/A	IN2	N/A	N/A	N/A	N/A	IN1	N/A	IN6	N/A	N/A	IN5	N/A	N/A

Figure 9 - Physical Input Mapping

Programmable Input Definitions

Physical Input: The opto-isolated binary input that allows external control by physically wiring the input terminals of the relay. Physical inputs are labeled (IN1, IN2, IN3, ..., 43A, 52A, 52B).

Logical Input: An input equated by the boolean combination of the physical inputs. These inputs are used by the relay's state machine and control subroutines. Logical Inputs are labeled (PH3, GRD, TCM, ...). See protocol document paragraph 4.1 for additional labels.

Active Open: This defines the type of connection from the physical input or inputs and means the physical state of the opto-isolator's logic is inverted. Example: if the voltage across IN1's terminals equals zero, then the boolean equation will evaluate this term as a logical one. Likewise, when a voltage is applied to IN1, the boolean equation will evaluate this term as a logical zero.

Active Closed: This defines the type of connection from the physical input or inputs and means that the physical state of the opto-isolator's logic is the non-inverted. Example: if a voltage is applied across IN1's terminals, then the boolean equation will evaluate this term as a logical one. Likewise, when a voltage is applied to IN1, the boolean equation will evaluate this term as a logical zero.

Example of a boolean input equation:

Logical ORed Physical
50-1 = IN1 + IN2 + IN3

Logical ANDed Physical
GRD = IN1 * IN2 * IN3

Input Select: The physical inputs are associated with a bit mask to determine which inputs are used when resolving the logical input's boolean equation. If the appropriate bit is set, the term will be included as part of the equation. Likewise, a cleared bit indicates that the physical input term will be ignored.

The bit assignment mask for the physical inputs are as follows:

0 = IN3, 1 = IN4, 2 = IN9, 3 = IN2, 4 = IN10, 5 = 43A, 6 = 52B, 7 = 52A, 8 = IN1, 9 = IN11, 10 = IN8, 11 = IN7, 12 = IN6, 13 = IN5, 14 = IN13, 15 = IN12.

Negated AND Input: This is a bit mask that indicates if a selected input is inverted based on the active open or closed state. The bit mask uses the same associated physical inputs pattern as in the Input Select data.

AND/OR Select: The combination of the physical inputs' state used to resolve the boolean equation allows for the algebraic ANDing or ORing of all of the selected physical inputs.

User Definable Names: Physical inputs, IN1 - IN13, have memory allocated for an eight character (NULL is implied in character 9) user definable strings.

Four protocol commands are required to view or change the relay's programmable input setting tables. The command order for viewing these tables can be retrieved in any sequence, but when the settings are sent to the relay, the commands must be sent in the following sequence:

- 3 11 1: Recieve Programmable Input Select and Index data.
- 3 11 2: Recieve Programmable Negated AND Input data.
- 3 11 3: Recieve Programmable Input AND/OR Select data.
- 3 11 4: Recieve Programmable Input User Defined Name data.

Up to 29 logical inputs may selected at any one time. The protocol document refers to these generic logical inputs as INPUT1 - INPUT29.

Example:

We want the PH3 logical input to be the combination of the physical inputs IN4 AND NOT IN3 AND ALT1 logical input to be the combination of the physical inputs IN1 OR IN3 OR NOT IN5.

PH3 = IN4 * !IN3
ALT1 = IN1 + IN3 + !IN5

First, generic inputs must be selected to setup the logic equation and for this case INPUT3 is used for PH3 and INPUT8 is used for ALT1. Note, any inputs 1-29 could be valid selections. The data values required for these selections use the the INDEX table defined in the protocol document in section 4.1 and 11.1.

<u>Command</u>	<u>Msg/byte</u>	<u>HexData</u>	<u>Comment</u>
3 11 1	5/1	0xFF	No physicals selected for INPUT3 Input Select high byte
3 11 1	5/2	0xFA	Selects IN3 and IN4 bits for INPUT3 Input Select low byte
3 11 1	5/3	0x03	Assigning PH3 offset to INPUT3 for Input Index
3 11 1	10/1	0xB7	Selects IN1 and IN5 bits for INPUT8 Input Select high byte
3 11 1	10/2	0xF7	Selects IN3 bit for INPUT8 Input Select low byte
3 11 1	10/3	0x03	Assigning ALT1 offset to INPUT8 for Input Index
3 11 2	4/1	0xFF	No physical's logic inverted for INPUT3 Negated AND Input high byte
3 11 2	4/2	0xF7	Inverts IN3's logical state for INPUT3 Negated AND Input low byte
3 11 2	7/3	0xBF	Inverts IN5's logical state for INPUT8 Negated AND Input high byte
3 11 2	8/1	0xFF	No physical's logic inverted for INPUT8 Negated AND Input low byte
3 11 3	3/1	0x00	Boolean combination of INPUT3 selected
3 11 3	3/2	0x00	physical logic are ANDed, all other
3 11 3	3/3	0x00	INPUT1,2,4-29 are ORed together
3 11 3	4/1	0x04	

Bit = 0, Physical Input is selected.
 Bit = 1, Physical Input is not selected.
 Low byte consists of bits 0 through 7.
 High byte consists of bits 8 through 15.
 Index byte is the offset into the DPU's logical input structure.

Logical Input List for DPU2000 - Requires matrix (29 x 16) to allow user to map 29 Logical Inputs to 13 Physical Inputs plus "43A", "52A", and "52B". Logical Inputs include: "TCM", "GRD", "PH3", "50-1", "50-2", "50-3", "ALT1", "ALT2", "ZSC", "SCC", "79S", "79M", "OPEN", "CLOSE", "ECI1", "ECI2", "WCI", "46", "67P", "67N", "ULI1", "ULI2", "ULI3", "ULI4", "ULI5", "ULI6", "ULI7", "ULI8", "ULI9", "CRI", "UDI".

Logical Input List for DPU2000R - Requires matrix (29 x 16) to allow user to map 29 Logical Inputs to 8 Physical Inputs plus 8 Feedback Inputs. Logical Inputs include: "52A", "52B", "43A", "TCM", "GRD", "PH3", "50-1", "50-2", "50-3", "ALT1", "ALT2", "ZSC", "SCC", "79S", "79M", "OPEN", "CLOSE", "ECI1", "ECI2", "WCI", "46", "67P", "67N", "ULI1", "ULI2", "ULI3", "ULI4", "ULI5", "ULI6", "ULI7", "ULI8", "ULI9", "CRI", "ARCI", "TARC", "SEF" (*Sensitive Earth Model*), "EXTBF", "BFI", "UDI", "25" (*Synch Check Model*), "25By" (*Synch Check Model*). The following logical inputs are available in CPU versions greater than 1.92: "LOCAL", "TGT", "SIA". The following logical inputs are available in CPU version greater than 4.02 (2.01 for PTH): LIS1, LIS2, LIS3, LIS4, LIS5, LIS6, LIS7, LIS8, LIR1, LIR2, LIR3, LIR4, LIR5, LIR6, LIR7, LIR8, TR_SET, TR_RST.

Logical Input List for DPU1500R - Requires matrix (29 x 6) to allow user to map 29 Logical Inputs to 6 Physical Inputs. Logical Inputs include: "52A", "52B", "43A", "TCM", "GRD", "PH3", "50-1", "50-2", "50-3", "ALT1", "ALT2", "ZSC", "SCC", "79S", "79M", "OPEN", "CLOSE", "ECI1", "ECI2", "WCI", "46", "CRI", "ARCI", "TARC", "SEF" (*Sensitive Earth Model*), "UDI", "LOCAL", "TGT", "SIA".

Below is the complete listing of Logical Input Offsets and their respective definitions.

<u>Offset</u>	<u>Definitions</u>
00	52A Breaker Position - Closed/Opened
01	52B Breaker Position - Opened/Closed
02	43A Reclose Function - Enabled/Disabled
03	PH3 Phase Torque Control
04	GRD Ground Torque Control
05	SCC Spring Charging Contact
06	79S Single Shot Reclosing
07	79M Multi Shot Reclosing
08	TCM Trip Coil Monitoring
09	50-1 Instantaneous 50P-1 50N-1
10	50-2 Instantaneous 50P-2 50N-2
11	50-3 Instantaneous 50P-3 50N-3

12	ALT1	Enables ALT1 settings table
13	ALT2	Enables ALT2 settings table
14	ECI1	Event Capture Initiated data in fault record
15	ECI2	Event Capture Initiated data in fault record
16	WCI	Waveform Capture Initiated
17	Zone	Sequence Coordination
18	Open	Trip initiated
19	Close	Initiated
20	46	Enables 46 Function
21	67P	Enables 67P Function
22	67N	Enables 67N Function
23	ULI1	User Logical Input Asserts ULO1
24	ULI2	User Logical Input Asserts ULO2
25	ULI3	User Logical Input Asserts ULO3
26	ULI4	User Logical Input Asserts ULO4
27	ULI5	User Logical Input Asserts ULO5
28	ULI6	User Logical Input Asserts ULO6
29	ULI7	User Logical Input Asserts ULO7
30	ULI8	User Logical Input Asserts ULO8
31	ULI9	User Logical Input Asserts ULO9
32	CRI	Resets Overcurrent Trip And all Recloser Counters
33	ARCI	Timed Reclose Block
34	TARC	Initiate Trip and Automatic Reclose
35	SEF	Sensitive Earth Fault Enable
36	EXTBFI	External Starter Input
37	BFI	Breaker Fail Initiate
38	UDI	User-defined Display Input
39	25	
40	25By	
41	LOCAL	Local Enable
42	TGT	
43	SIA	
44	LIS1	Latching logical input 1 set
45	LIS2	Latching logical input 2 set
46	LIS3	Latching logical input 3 set
47	LIS4	Latching logical input 4 set
48	LIS5	Latching logical input 5 set
49	LIS6	Latching logical input 6 set
50	LIS7	Latching logical input 7 set
51	LIS8	Latching logical input 8 set
52	LIR1	Latching logical input 1 reset
53	LIR2	Latching logical input 2 reset
54	LIR3	Latching logical input 3 reset
55	LIR4	Latching logical input 4 reset
56	LIR5	Latching logical input 5 reset
57	LIR6	Latching logical input 6 reset
58	LIR7	Latching logical input 7 reset
59	LIR8	Latching logical input 8 reset
60	TR_SET	Hot hold tagging logical input set
61	TR_RST	Hot hold tagging logical input reset

Example : if message 2/1 = hex 24
 2/2 = hex 11
 2/3 = hex 4

Then I/O word is 00100100 00010001 hex 2411. All of these outputs are mapped onto GND (04 offset). Note the Physical Inputs are translated using the physical input table below.

In the example IN3, IN10, IN8 and IN5 are selected for GND. The AND/OR selection and enable/disable mapping is selected with commands 3 11 3 and 3 11 2.

<u>Msg byte</u>	<u>Definition</u>
1/1	Relay Status (Note: the relay status is cleared by the 3 0 8 command) Bits that are set to 1 is an indication the condition exists. <ul style="list-style-type: none"> Bit 0 : SelfTest Status Bit 1 : Contact Input Status changed Bit 2 : Local Settings Change Bit 3 : Remote Edit Disabled. Bit 4 : Alternate Settings Group 1 Active. Bit 5 : Alternate Setting Group 2 Active. Bit 6 : Fault Record Logged. Bit 7 : Power was Cycled
1/2	Command + Subcommand = 0x41
1/3	Total Number of Messages = 31
2/1	INPUT1 high byte
2/2	INPUT1 low byte
2/3	INPUT1 index byte
3/1	INPUT2 high byte
3/2	INPUT2 low byte
3/3	INPUT2 index byte
4/1	INPUT3 high byte
4/2	INPUT3 low byte
4/3	INPUT3 index byte
5/1	INPUT4 high byte
5/2	INPUT4 low byte
5/3	INPUT4 index byte
6/1	INPUT5 high byte
6/2	INPUT5 low byte
6/3	INPUT5 index byte
7/1	INPUT6 high byte
7/2	INPUT6 low byte
7/3	INPUT6 index byte
8/1	INPUT7 high byte
8/2	INPUT7 low byte
8/3	INPUT7 index byte
9/1	INPUT8 high byte
9/2	INPUT8 low byte
9/3	INPUT8 index byte
10/1	INPUT9 high byte
10/2	INPUT9 low byte
10/3	INPUT9 index byte
11/1	INPUT10 high byte
11/2	INPUT10 low byte
11/3	INPUT10 index byte
12/1	INPUT11 high byte
12/2	INPUT11 low byte
12/3	INPUT11 index byte
13/1	INPUT12 high byte
13/2	INPUT12 low byte
13/3	INPUT12 index byte
14/1	INPUT13 high byte
14/2	INPUT13 low byte
14/3	INPUT13 index byte
15/1	INPUT14 high byte
15/2	INPUT14 low byte

15/3	INPUT14 index byte
16/1	INPUT15 high byte
16/2	INPUT15 low byte
16/3	INPUT15 index byte
17/1	INPUT16 high byte
17/2	INPUT16 low byte
17/3	INPUT16 index byte
18/1	INPUT17 high byte
18/2	INPUT17 low byte
18/3	INPUT17 index byte
19/1	INPUT18 high byte
19/2	INPUT18 low byte
19/3	INPUT18 index byte
20/1	INPUT19 high byte
20/2	INPUT19 low byte
20/3	INPUT19 index byte
21/1	INPUT20 high byte
21/2	INPUT20 low byte
21/3	INPUT20 index byte
22/1	INPUT21 high byte
22/2	INPUT21 low byte
22/3	INPUT21 index byte
23/1	INPUT22 high byte
23/2	INPUT22 low byte
23/3	INPUT22 index byte
24/1	INPUT23 high byte
24/2	INPUT23 low byte
24/3	INPUT23 index byte
25/1	INPUT24 high byte
25/2	INPUT24 low byte
25/3	INPUT24 index byte
26/1	INPUT25 high byte
26/2	INPUT25 low byte
26/3	INPUT25 index byte
27/1	INPUT26 high byte
27/2	INPUT26 low byte
27/3	INPUT26 index byte
28/1	INPUT27 high byte
28/2	INPUT27 low byte
28/3	INPUT27 index byte
29/1	INPUT28 high byte
29/2	INPUT28 low byte
29/3	INPUT28 index byte
30/1	INPUT29 high byte
30/2	INPUT29 low byte
30/3	INPUT29 index byte
31/1	spare
31/2	Checksum high byte
31/3	Checksum low byte

5.4.2 Transmit Programmable Input Negated AND Input (3 4 2)

Negated Programmable Input data transferred from relay to PC.

- Bit = 0, Enabled when input is opened.
- Bit = 1, Enabled when input is closed.
- Low byte consists of bits 0 through 7.
- High byte consists of bits 8 through 15.

<u>Msg byte</u>	<u>Definition</u>
1/1	Relay Status (see command 3 4 1, msg 1/1)
1/2	Command + Subcommand = 0x42
1/3	Total Number of Messages = 21
2/1	INPUT1 high byte
2/2	INPUT1 low byte
2/3	INPUT2 high byte
3/1	INPUT2 low byte
3/2	INPUT3 high byte
3/3	INPUT3 low byte
4/1	INPUT4 high byte
4/2	INPUT4 low byte
4/3	INPUT5 high byte
5/1	INPUT5 low byte
5/2	INPUT6 high byte
5/3	INPUT6 low byte
6/1	INPUT7 high byte
6/2	INPUT7 low byte
6/3	INPUT8 high byte
7/1	INPUT8 low byte
7/2	INPUT9 high byte
7/3	INPUT9 low byte
8/1	INPUT10 high byte
8/2	INPUT10 low byte
8/3	INPUT11 high byte
9/1	INPUT11 low byte
9/2	INPUT12 high byte
9/3	INPUT12 low byte
10/1	INPUT13 high byte
10/2	INPUT13 low byte
10/3	INPUT14 high byte
11/1	INPUT14 low byte
11/2	INPUT15 high byte
11/3	INPUT15 low byte
12/1	INPUT16 high byte
12/2	INPUT16 low byte
12/3	INPUT17 high byte
13/1	INPUT17 low byte
13/2	INPUT18 high byte
13/3	INPUT18 low byte
14/1	INPUT19 high byte
14/2	INPUT19 low byte
14/3	INPUT20 high byte
15/1	INPUT20 low byte
15/2	INPUT21 high byte
15/3	INPUT21 low byte
16/1	INPUT22 high byte
16/2	INPUT22 low byte
16/3	INPUT23 high byte
17/1	INPUT23 low byte
17/2	INPUT24 high byte
17/3	INPUT24 low byte
18/1	INPUT25 high byte
18/2	INPUT25 low byte
18/3	INPUT26 high byte
19/1	INPUT26 low byte
19/2	INPUT27 high byte
19/3	INPUT27 low byte
20/1	INPUT28 high byte

20/2	INPUT28 low byte
20/3	INPUT29 high byte
21/1	INPUT29 low byte
21/2	Checksum high byte
21/3	Checksum low byte

5.4.3 Transmit Programmable Input AND/OR Select (3 4 3)

Bit = 0, Selected inputs are ORed together.
 Bit = 1, Selected inputs are ANDed together.

<u>Bit</u>	<u>Logical Input</u>
0	INPUT1
1	INPUT2
.	.
.	.
.	.
27	INPUT28
28	INPUT29
29	not used reserved for 52A
30	not used reserved for 52B
31	not used reserved for 43A

<u>Msg byte</u>	<u>Definition</u>
1/1	Relay Status (see command 3 4 1, msg 1/1)
1/2	Command + Subcommand = 0x43
1/3	Total Number of Messages = 3
2/1	Programmable input AND/OR selection bits 24-31
2/2	Programmable input AND/OR selection bits 16-23
2/3	Programmable input AND/OR selection bits 8-15
3/1	Programmable input AND/OR selection bits 0-7
3/2	Checksum high byte
3/3	Checksum low byte

5.4.4 Transmit Programmable User Defined Input Names (3 4 4)

User definable 8 char input strings. Byte 9 is an implied NULL.

<u>Msg byte</u>	<u>Definition</u>
1/1	Relay Status (see command 3 4 1, msg 1/1)
1/2	Command + Subcommand = 0x44
1/3	Total Number of Messages = 37
2/1-4/2	IN1 Character String 8 bytes
4/3-7/1	IN2 Character String 8 bytes
7/2-9/3	IN3 Character String 8 bytes
10/1-12/2	IN4 Character String 8 bytes
12/3-15/1	IN5 Character String 8 bytes
15/2-17/3	IN6 Character String 8 bytes
18/1-20/2	IN7 Character String 8 bytes (DPU2000 and DPU2000R)
20/3-23/1	IN8 Character String 8 bytes (DPU2000 and DPU2000R)
23/2-25/3	IN9 Character String 8 bytes (DPU2000)
26/1-28/2	IN10 Character String 8 bytes (DPU2000)
28/3-31/1	IN11 Character String 8 bytes (DPU2000)
31/2-33/3	IN12 Character String 8 bytes (DPU2000)
34/1-36/2	IN13 Character String 8 bytes (DPU2000)
36/3-37/1	Spare Input Strings
37/2	Checksum high byte
37/3	Checksum low byte

5.4.5 Transmit Programmable Output Select (3 4 5)

Bit Position:	0	1	2	3	4	5	6	7	8	9	10	11	12	13	14	15
DPU2000:	Trip	Close	Out6	Out4	Out5	Out3	Out2	Out1	Out7	Out8	N/A	N/A	N/A	N/A	N/A	N/A
DPU2000R:	Trip	N/A	Out6	Out4	Out5	Out3	Out2	Out1	FB1	FB2	FB3	FB4	FB5	FB6	FB7	FB8
DPU1500R:	Trip	N/A	Out6	Out4	Out5	Out3	Out2	Out1	N/A	N/A	N/A	N/A	N/A	N/A	N/A	N/A

Figure 10 - Physical Output Mapping

- Bit = 0, Physical Output is selected.
- Bit = 1, Physical Output is not selected.
- Least significant low byte consists of bits 0 through 7.
- Least significant high byte consists of bits 8 through 15.
- Most significant low byte consists of bits 16 through 23.
- Most significant high byte consists of bits 24 through 31.

<u>Bit</u>	<u>Logical Output</u>
0	TRIP (Fixed)
1	CLOSE (Fixed DPU2000, mapping NOT permitted by DPU2000R or DPU1500R)
2	OUTPUT1
3	OUTPUT2
.	.
.	.
.	.
30	OUTPUT29
31	OUTPUT30

<u>Msg byte</u>	<u>Definition</u>
1/1	Relay Status (see command 3 4 1, msg 1/1)
1/2	Command + Subcommand = 0x45
1/3	Total Number of Messages = 21
2/1	Contact OUT6 most significant high byte
2/2	Contact OUT6 most significant low byte
2/3	Contact OUT6 least significant high byte
3/1	Contact OUT6 least significant low byte
3/2	Contact OUT4 most significant high byte
3/3	Contact OUT4 most significant low byte
4/1	Contact OUT4 least significant high byte
4/2	Contact OUT4 least significant low byte
4/3	Contact OUT5 most significant high byte
5/1	Contact OUT5 most significant low byte
5/2	Contact OUT5 least significant high byte
5/3	Contact OUT5 least significant low byte
6/1	Contact OUT3 most significant high byte
6/2	Contact OUT3 most significant low byte
6/3	Contact OUT3 least significant high byte
7/1	Contact OUT3 least significant low byte
7/2	Contact OUT2 most significant high byte
7/3	Contact OUT2 most significant low byte
8/1	Contact OUT2 least significant high byte
8/2	Contact OUT2 least significant low byte
8/3	Contact OUT1 most significant high byte
9/1	Contact OUT1 most significant low byte
9/2	Contact OUT1 least significant high byte
9/3	Contact OUT1 least significant low byte
10/1	Contact OUT7 most significant high byte (DPU2000)
	DPU2000R FB1 most significant high byte
10/2	Contact OUT7 most significant low byte (DPU2000)
	DPU2000R FB1 most significant low byte

10/3	Contact OUT7 least significant high byte (DPU2000) DPU2000R FB1 least significant high byte
11/1	Contact OUT7 least significant low byte (DPU2000) DPU2000R FB1 least significant low byte
11/2	Contact OUT8 most significant high byte (DPU2000) DPU2000R FB2 most significant high byte
11/3	Contact OUT8 most significant low byte (DPU2000) DPU2000R FB2 most significant low byte
12/1	Contact OUT8 least significant high byte (DPU2000) DPU2000R FB2 least significant high byte
12/2	Contact OUT8 least significant low byte (DPU2000) DPU2000R FB2 least significant low byte
12/3	DPU2000R FB3 most significant high byte
13/1	DPU2000R FB3 most significant low byte
13/2	DPU2000R FB3 least significant high byte
13/3	DPU2000R FB3 least significant low byte
14/1	DPU2000R FB4 most significant high byte
14/2	DPU2000R FB4 most significant low byte
14/3	DPU2000R FB4 least significant high byte
15/1	DPU2000R FB4 least significant low byte
15/2	DPU2000R FB5 most significant high byte
15/3	DPU2000R FB5 most significant low byte
16/1	DPU2000R FB5 least significant high byte
16/2	DPU2000R FB5 least significant low byte
16/3	DPU2000R FB6 most significant high byte
17/1	DPU2000R FB6 most significant low byte
17/2	DPU2000R FB6 least significant high byte
17/3	DPU2000R FB6 least significant low byte
18/1	DPU2000R FB7 most significant high byte
18/2	DPU2000R FB7 most significant low byte
18/3	DPU2000R FB7 least significant high byte
19/1	DPU2000R FB7 least significant low byte
19/2	DPU2000R FB8 most significant high byte
19/3	DPU2000R FB8 most significant low byte
20/1	DPU2000R FB8 least significant high byte
20/2	DPU2000R FB8 least significant low byte
20/3	Spare
21/1	Spare
21/2	Checksum high byte
21/3	Checksum low byte

5.4.6 Transmit Programmable Output AND/OR Select (3 4 6)

Bit = 0, Selected inputs are ORed together.

Bit = 1, Selected inputs are ANDed together.

Index byte is the offset into the DPU's logical output structure.

Logical Output List for DPU2000 - Requires matrix (32 x 8) to allow user to map 32 Logical Outputs to 8 Physical Outputs.

NOTE: first two logicals, **TRIP** and **CLOSE** are fixed (bits 0 and 1), user is not permitted to remove these from the list. Logical Outputs include: "TRIP", "CLOSE", "ALARM", "BFA", "TCFA", "79LOA", "TCC", "PUA", "51P", "51N", "46", "50P-1", "50N-1", "50P-2", "50N-2", "50P-3", "50N-3", "PATA", "PBTA", "PCTA", "67P", "67N", "81S-1", "81R-1", "81O-1", "27-1P", "59", "79DA", "79CA1", "OCTC", "KSI", "PDA", "NDA", "PVAra", "NVAra", "LOADA", "50-1D", "LPFA", "HPFA", "ZSC", "50-2D", "BFUA", "STCA", "PH3-D", "GRD-D", "32PA", "32NA", "27-3P", "VarDA", "79CA2", "TRIPA", "TRIPB", "TRIPC", "27-1P*", "46*", "50P-1*", "50N-1*", "50P-2*", "50N-2*", "50P-3*", "50N-3*", "51P*", "51N*", "59*", "67P*", "67N*", "81S-1*", "81R-1*", "81O-1*", "27-3P*", "TRIPA*", "TRIPB*", "TRIPC*", "ULO1", "ULO2", "ULO3", "ULO4", "ULO5", "ULO6", "ULO7", "ULO8", "ULO9", "81O-2", "81S-2", "81R-2", "81O-2*", "81S-2*", "81R-2*", "CLTA", "PWatt1", "PWatt2", "79CA1*", "79CA2*", "BFA*".

Logical Output List for DPU2000R - Requires matrix (31 x 14) to allow user to map 31 Logical Outputs to 6 Physical Outputs plus 8 Feedback Outputs. NOTE: first logical, **TRIP** is fixed, user is not permitted to remove Trip logical from the

list. Also note, since the **CLOSE** logical is specific to DPU2000, mapping of this logical (located at bit 1) is NOT permissible. Logical Outputs include: "TRIP", "CLOSE", "ALARM", "BFA", "TCFA", "79LOA", "TCC", "PUA", "51P", "51N", "46", "50P-1", "50N-1", "50P-2", "50N-2", "50P-3", "50N-3", "PATA", "PBTA", "PCTA", "67P", "67N", "81S-1", "81R-1", "81O-1", "27-1P", "59", "79DA", "79CA1", "OCTC", "KSI", "PDA", "NDA", "PVArA", "NVArA", "LOADA", "50-1D", "LPFA", "HPFA", "ZSC", "50-2D", "BFUA", "STCA", "PH3-D", "GRD-D", "32PA", "32NA", "27-3P", "VarDA", "79CA2", "TRIPA", "TRIPB", "TRIPC", "TRIPC", "27-1P*", "46*", "50P-1*", "50N-1*", "50P-2*", "50N-2*", "50P-3*", "50N-3*", "51P*", "51N*", "59*", "67P*", "67N*", "81S-1*", "81R-1*", "81O-1*", "27-3P*", "TRIPA*", "TRIPB*", "TRIPC*", "ULO1", "ULO2", "ULO3", "ULO4", "ULO5", "ULO6", "ULO7", "ULO8", "ULO9", "81O-2", "81S-2", "81R-2", "81O-2*", "81S-2*", "81R-2*", "CLTA", /* V1.40 */ "PWatt1", "PWatt2", "79CA1*", "79CA2*". The following were added to CPU V1.60: "SEF*" (*Sensitive Earth Model*), "SEF" (*Sensitive Earth Model*), "BZA", "BFT", "ReTrp", "BFT*", "ReTrp*". The following were added to CPU V1.80: "32P-2", "32N-2", "32P-2*", "32N-2*", "BFA*".

The following were added to CPU V1.93: "25*" (*Synch Check Model*), "25" (*Synch Check Model*), "SBA".

The following were added to CPU V3.20: "79V" and "RClIn", "59G", "59G*", "LO1", "LO2", "LO3", "LO4", "LO5", "LO6", "LO7", "LO8", "TR_ON", "TR_OFF", "TR_TAG".

The following were added to CPU V5.0: 59-3P, 59-3P*, 47, 47*, 21P-1, 21P-1*, 21P-2, 21P-2*, 21P-3, 21P-3*, 21P-4, 21P-4*.

Logical Output List for DPU1500R - Requires matrix (31 x 6) to allow user to map 31 Logical Outputs to 6 Physical Outputs. NOTE: first logical, **TRIP** is fixed, user is not permitted to remove Trip logical from the list. Also note, since the **CLOSE** logical is specific to DPU2000, mapping of this logical (located at bit 1) is NOT permissible. Logical Outputs include: "TRIP", "CLOSE", "ALARM", "BFA", "TCFA", "79LOA", "TCC", "PUA", "51P", "51N", "46", "50P-1", "50N-1", "50P-2", "50N-2", "50P-3", "50N-3", "PATA", "PBTA", "PCTA", "27-1P", "79DA", "79CA1", "OCTC", "KSI", "PDA", "NDA", "PVArA", "NVArA", "LOADA", "50-1D", "LPFA", "HPFA", "ZSC", "50-2D", "BFUA", "STCA", "PH3-D", "GRD-D", "27-3P", "VarDA", "79CA2", "TRIPA", "TRIPB", "TRIPC", "TRIPC", "27-1P*", "46*", "50P-1*", "50N-1*", "50P-2*", "50N-2*", "50P-3*", "50N-3*", "51P*", "51N*", "27-3P*", "TRIPA*", "TRIPB*", "TRIPC*", "CLTA", "PWatt1", "PWatt2", "79CA1*", "79CA2*", "SEF*" (*Sensitive Earth Model*), "SEF" (*Sensitive Earth Model*), "BZA", "BFA*", "SBA", "79V" and "RClIn".

Complete listing of Logical Output Offsets and respective definitions below.

<u>Index</u>	<u>Logical Output</u>	<u>Definitions</u>
00	TRIP	Fixed Trip
01	CLOSE	Fixed Close (DPU2000)
02	Alarm	Self Check Alarm
03	27-1P	Single Phase Under Voltage
04	46	Negative Sequence Overcurrent
05	50P-1	Phase Inst Overcurrent
06	50N-1	Neutral Inst Overcurrent
07	50P-2	Phase Inst Overcurrent
08	50N-2	Neutral Inst Overcurrent
09	50P-3	Phase Inst Overcurrent
10	50N-3	Neutral Inst Overcurrent
11	51P	Phase Time Overcurrent
12	51N	Neutral Time Overcurrent
13	59	Over Voltage
14	67P	Directional Overcurrent (pos seq)
15	67N	Directional Overcurrent (neg seq)
16	81S-1	Frequency Shed (First stage)
17	81R-1	Frequency Restore (First stage)
18	PATA	Phase A Target
19	PATB	Phase B Target
20	PATC	Phase C Target
21	TCFA	Trip Circuit Fail
22	TCC	Tap Changer Cutout
23	79DA	Recloser Disable
24	PUA	Pickup
25	79LOA	Recloser Lockout
26	BFA	Breaker Fail
27	PDA	Phase Peak Demand

28	NDA	Neutral Peak Demand
29	BFUA	Blown Fuse
30	KSI	KiloAmp Summation
31	79CA-1	Reclose Counter1
32	HPFA	High Power Factor
33	LPFA	Low Power Factor
34	OCTC	Overcurrent Trip Counter
35	50-1D	50-1 Element Disable
36	50-2D	50-2 Element Disable
37	STC	Setting Table Change
38	ZSC	Zone Sequence
39	PH3-D	Phase Torque Control Disable
40	GRD-D	Neutral Torque Control Disable
41	32PA	Directional Pickup (pos seq)
42	32NA	Directional Pickup (neg seq)
43	27-3P	3 Phase Under Voltage
44	VarDA	Var Demand
45	79CA-2	Reclose Counter2
46	TRIPA	Single Pole Trip Phase A
47	TRIPB	Single Pole Trip Phase B
48	TRIPC	Single Pole Trip Phase C
49	27-1P*	Single Phase Under Voltage
50	46*	Negative Sequence Overcurrent
51	50P-1*	Phase Inst Overcurrent
52	50N-1*	Neutral Inst Overcurrent
53	50P-2*	Phase Inst Overcurrent
54	50N-2*	Neutral Inst Overcurrent
55	50P-3*	Phase Inst Overcurrent
56	50N-3*	Neutral Inst Overcurrent
57	51P*	Phase Time Overcurrent
58	51N*	Neutral Time Overcurrent
59	59*	Over Voltage
60	67P*	Directional Overcurrent (pos seq)
61	67N*	Directional Overcurrent (neg seq)
62	81S-1*	Frequency Shed (First stage)
63	81R-1*	Frequency Restore (First stage)
64	81O-1*	Over Frequency (First stage)
65	27-3P*	3 Phase Under Voltage
66	TRIPA*	Single Pole Trip Phase A
67	TRIPB*	Single Pole Trip Phase B
68	TRIPC*	Single Pole Trip Phase C
69	ULO1	User Logical Output 1
70	ULO2	User Logical Output 2
71	ULO3	User Logical Output 3
72	ULO4	User Logical Output 4
73	ULO5	User Logical Output 5
74	ULO6	User Logical Output 6
75	ULO7	User Logical Output 7
76	ULO8	User Logical Output 8
77	ULO9	User Logical Output 9
78	PVArA	Positive VAr
79	NVArA	Negative VAr
80	LOADA	Load Current
81	81O-1	Over Frequency (First Stage)
82	81O-2	Over Frequency (2nd Stage)
83	81S-2	Frequency Shed (2nd Stage)
84	81R-2	Frequency Restore (2nd Stage)
85	81O-2*	Over Frequency (2nd Stage)
86	81S-2*	Frequency Shed (2nd Stage)

87	81R-2*	Frequency Restore (2nd Stage)
88	CLTA	Cold Load Timer
89	PWatt1	Positive Watt Alarm 1
90	PWatt2	Positive Watt Alarm 2
91	79CA1*	Recloser Counter 1 Alarm
92	79CA2*	Recloser Counter 2 Alarm
93	SEF*	Sensitive Earth Fault Trip
94	SEF	Sensitive Earth Fault Trip
95	BZA	Bus Zone Alarm
96	BFT	Breaker Failure Trip Alarm
97	RETRIP	Breaker Failure Re-Trip Alarm
98	BFT*	Breaker Failure Trip Alarm
99	RETRIP*	Breaker Failure Re-Trip Alarm
100	32P-2	Phase Power Directional Alarm
101	32N-2	Neutral Power Directional Alarm
102	32P-2*	Phase Power Directional Alarm
103	32N-2*	Neutral Power Directional Alarm
104	BFA*	Breaker Failure Alarm Seal in
105	25*	Synch Check Alarm Seal in
106	25	Synch Check Alarm
107	SBA	Slow Breaker Alarm
108	79V	
109	Rclin	
110	59G	59G logical output
111	59G*	59G logical output seal in
112	LO1	Latching logical output 1
113	LO2	Latching logical output 2
114	LO3	Latching logical output 3
115	LO4	Latching logical output 4
116	LO5	Latching logical output 5
117	LO6	Latching logical output 6
118	LO7	Latching logical output 7
119	LO8	Latching logical output 8
120	TR_ON	Hot hold tagging logical output On
121	TR_OFF	Hot hold tagging logical output Off
122	TR_TAG	Hot hold tagging logical output Tag
123	59-3P	3-Phase Over-voltage alarm
124	59-3P*	3-Phase Over-voltage seal-in alarm
125	47	Negative sequence over-voltage alarm
126	47*	Negative sequence over-voltage seal-in alarm
127	spare	Not used.
128	21P-1	Forward reach Zone 1 Distance alarm
129	21P-1*	Forward reach Zone 1 Distance seal-in alarm
130	21P-2	Forward reach Zone 2 Distance alarm
131	21P-2*	Forward reach Zone 2 Distance seal-in alarm
132	21P-3	Forward reach Zone 3 Distance alarm
133	21P-3*	Forward reach Zone 3 Distance seal-in alarm
134	21P-4	Forward reach Zone 4 Distance alarm
135	21P-4*	Forward reach Zone 4 Distance seal-in alarm

Msg byte

Definition

1/1	Relay Status (see command 3 4 1, msg 1/1)
1/2	Command + Subcommand = 0x46
1/3	Total Number of Messages = 13
2/1	spare (bits 24-31)
2/2	spare (bits 16-23)
2/3	Programmable output AND/OR selection bits 8-15
3/1	Programmable output AND/OR selection bits 0-7
3/2	OUTPUT1 index byte

3/3	OUTPUT2 index byte
4/1	OUTPUT3 index byte
4/2	OUTPUT4 index byte
4/3	OUTPUT5 index byte
5/1	OUTPUT6 index byte
5/2	OUTPUT7 index byte
5/3	OUTPUT8 index byte
6/1	OUTPUT9 index byte
6/2	OUTPUT10 index byte
6/3	OUTPUT11 index byte
7/1	OUTPUT12 index byte
7/2	OUTPUT13 index byte
7/3	OUTPUT14 index byte
8/1	OUTPUT15 index byte
8/2	OUTPUT16 index byte
8/3	OUTPUT17 index byte
9/1	OUTPUT18 index byte
9/2	OUTPUT19 index byte
9/3	OUTPUT20 index byte
10/1	OUTPUT21 index byte
10/2	OUTPUT22 index byte
10/3	OUTPUT23 index byte
11/1	OUTPUT24 index byte
11/2	OUTPUT25 index byte
11/3	OUTPUT26 index byte
12/1	OUTPUT27 index byte
12/2	OUTPUT28 index byte
12/3	OUTPUT29 index byte
13/1	OUTPUT30 index byte
13/2	Checksum high byte
13/3	Checksum low byte

5.4.7 Transmit Programmable Output User Defined Strings (3 4 7)

User definable 8 char output strings. Byte 9 is an implied NULL

<u>Msg byte</u>	<u>Definition</u>
1/1	Relay Status (see command 3 4 1, msg 1/1)
1/2	Command + Subcommand = 0x47
1/3	Total Number of Messages = 37
2/1-4/2	OUT1 Character String 8 bytes
4/3-7/1	OUT2 Character String 8 bytes
7/2-9/3	OUT3 Character String 8 bytes
10/1-12/2	OUT4 Character String 8 bytes
12/3-15/1	OUT5 Character String 8 bytes
15/2-17/3	OUT6 Character String 8 bytes
18/1-20/2	OUT7 Character String 8 bytes (DPU2000)
20/3-23/1	OUT8 Character String 8 bytes (DPU2000)
23/2-25/3	Spare Character String 8 bytes
26/1-28/2	Spare Character String 8 bytes
28/3-31/1	Spare Character String 8 bytes
31/2-33/3	Spare Character String 8 bytes
34/1-36/2	Spare Character String 8 bytes
36/3-39/1	Spare Character String 8 bytes
39/2	Checksum high byte
39/3	Checksum low byte

5.4.8 Transmit Relay Settings (3 4 x)

- (3 4 8) = Primary Settings
- (3 4 9) = Alternate 1 Settings
- (3 4 10) = Alternate 2 Settings

Low byte consists of bits 0 through 7.
 High byte consists of bits 8 through 15.

The following functions are available in the DPU1500R: 51P, 50P-1, 50P-2, 50P-3, 46, 51N, 50N-1, 50N-2, 50N-3, 79 and 27.

5.4.8.1 Standard ANSI Curves for DPU2000 and DPU2000R

Curve Selection Type I

- 0 = Extremely Inverse
- 1 = Very Inverse
- 2 = Inverse
- 3 = Short Time Inverse
- 4 = Definite Time
- 5 = Long Time Extremely Inverse
- 6 = Long Time Very Inverse
- 7 = Long Time Inverse
- 8 = Recloser Curve
- 9 = User Curve 1
- 10 = User Curve 2
- 11 = User Curve 3

Curve Type II

- 0 = Extremely Inverse
- 1 = Very Inverse
- 2 = Inverse
- 3 = Short Time Inverse
- 4 = Definite Time
- 5 = Long Time Extremely Inverse
- 6 = Long Time Very Inverse
- 7 = Long Time Inverse
- 8 = Recloser Curve
- 9 = Disable
- 10 = User Curve 1
- 11 = User Curve 2
- 12 = User Curve 3

Curve Selection Type III

- 0 = Disable
- 1 = Standard
- 2 = Inverse
- 3 = Definite Time
- 4 = Short Time Inverse
- 5 = Short Time Extremely Inverse
- 6 = User Curve 1
- 7 = User Curve 2
- 8 = User Curve 3

5.4.8.2 Recloser Curves for DPU2000 and DPU2000R

NOTE: Catalog Numbers XXXXXXXX-XX2XX and XXXXXXXX-XX3XX use the following curve types for 51P, 50P-1, 51N, and 50N-1 functions. Also, in addition to the Time Dial fields, include 51P, 50P-1, 51N and 50N-1 Minimum Response fields.

Recloser Curve (51P)

- 0 = A
- 1 = B
- 2 = C
- 3 = D
- 4 = E
- 5 = K
- 6 = N
- 7 = R
- 8 = W
- 9 = User Curve 1
- 10 = User Curve 2
- 11 = User Curve 3

Recloser Curve (51N)

- 0 = 2
- 1 = 3
- 2 = 8
- 3 = 8*
- 4 = 8+
- 5 = 9
- 6 = 11
- 7 = Disable
- 8 = User Curve 1
- 9 = User Curve 2
- 10 = User Curve 3

<u>Recloser Curve (50P-1)</u>	<u>Recloser Curve (50N-1)</u>
0 = Disable	0 = Disable
1 = A	1 = 2
2 = B	2 = 3
3 = C	3 = 8
4 = D	4 = 8*
5 = E	5 = 8+
6 = K	6 = 9
7 = N	7 = 11
8 = R	8 = User Curve 1
9 = W	9 = User Curve 2
10 = User Curve 1	10 = User Curve 3
11 = User Curve 2	
12 = User Curve 3	

5.4.8.3 IEC Curves for DPU2000R

NOTE: The following curves are available in IEC DPU2000R, Catalog Number 687XXXXX-XXXXX. All IEC type curves except Definite Time Curves, use Time Multipliers in place of Time Dials.

<u>IEC Curve Selection Type I</u>	<u>IEC Curve Type II</u>
0 = Extremely Inverse	0 = Disabled
1 = Very Inverse	1 = Extremely Inverse
2 = Inverse	2 = Very Inverse
3 = Long Time Inverse	3 = Inverse
4 = Definite Time	4 = Long Time Inverse
5 = User Curve 1	5 = Definite Time
6 = User Curve 2	6 = User Curve 1
7 = User Curve 3	7 = User Curve 2
	8 = User Curve 3

IEC Curve Selection Type III

- 0 = Disable
- 1 = Standard
- 2 = Definite Time
- 3 = User Curve 1
- 4 = User Curve 2
- 5 = User Curve 3

5.4.8.4 ANSI/IEC Curves for DPU1500R

NOTE: All IEC type curves, use Time Multipliers in place of Time Dials.

<u>Curve Selection Type I</u>	<u>Curve Type II</u>
0 = Extremely Inverse	0 = Extremely Inverse
1 = Very Inverse	1 = Very Inverse
2 = Inverse	2 = Inverse
3 = Short Time Inverse	3 = Short Time Inverse
4 = Definite Time	4 = Definite Time
5 = Long Time Extremely Inverse	5 = Long Time Extremely Inverse
6 = Long Time Very Inverse	6 = Long Time Very Inverse
7 = Long Time Inverse	7 = Long Time Inverse
8 = Recloser Curve	8 = Recloser Curve
9 = IEC Extremely Inverse	9 = Disable
10 = IEC Inverse	10 = IEC Extremely Inverse
11 = IEC Inverse	11 = IEC Very Inverse
12 = IEC Long Time Inverse	12 = IEC Inverse
13 = User Curve 1	13 = IEC Long Time Inverse
14 = User Curve 2	14 = User Curve 1
15 = User Curve 3	15 = User Curve 2
	16 = User Curve 3

Curve Selection Type III

- 0 = Disable
- 1 = Standard
- 2 = Inverse
- 3 = Definite Time
- 4 = Short Time Inverse
- 5 = Short Time Extremely Inverse
- 6 = User Curve 1
- 7 = User Curve 2
- 8 = User Curve 3

5.4.8.5 79-X Select Bit Pattern for DPU2000/2000R/1500R

79 Lockout and Enable/Disable bit pattern

Low Byte: 0 = No Lockout/Disable, 1 = Enabled

High Byte: 0 = Enable, 1 = Lockout

- bit 0: 50N-1 bit 8: 50N-1
- bit 1: 50N-2 bit 9: 50N-2
- bit 2: 50N-3 bit 10: 50N-3
- bit 3: 51N bit 11: 51N
- bit 4: 50P-1 bit 12: 50P-1
- bit 5: 50P-2 bit 13: 50P-2
- bit 6: 50P-3 bit 14: 50P-3
- bit 7: Reserved bit 15: Reserved

<u>Msg byte</u>	<u>Definition</u>
1/1	Relay Status (see command 3 4 1, msg 1/1)
1/2	Command + Subcommand = (Prim = 0x48, Alt1 = 0x49, Alt2 = 0x4a)
1/3	Total Number of Messages = 36
2/1	51P Curve Select byte (Type I or Recloser)
2/2	51P Pickup Amps byte (1-12Amp *10, 0.2-2.4Amp *50)
2/3	51P Time dial(1-10 *20)/delay byte(0-10 * 20) IEC Curve 51P Time Multiplier (.05-1.00 *200)
3/1	50P-1 Curve Select byte (Type III or Recloser)
3/2	50P-1 Pickup X byte (0.5-20 *10)
3/3	50P-1 Timedial (1-10 *10)/delay(0-9.99 *100) high byte IEC Curve -50P-1 Time Multiplier (.05-1.00 *200)
4/1	50P-1 Timedial/delay low byte
4/2	50P-2 Select byte (0=Disable, 1=Enable)
4/3	50P-2 Pickup X byte (0.5-20 *10)
5/1	50P-2 Timedelay high byte (0-9.99 *100)
5/2	50P-2 Timedelay low byte
5/3	50P-3 Select byte (0=Disable, 1=Enable)
6/1	50P-3 Pickup X byte (0.5-20 *10)
6/2	46 Curve Select byte (Type II)
6/3	46 Pickup Amps byte (1-12Amp *10, 0.2-2.4Amp *50)
7/1	46 Time dial(1-10 *20)/delay byte(0-10 * 20) IEC Curve -46 Time Multiplier (.05-1.00 *200)
7/2	51N Curve Select byte (Type II or Recloser)
7/3	51N Pickup Amps byte (1-12Amp *10, 0.2-2.4Amp *50)
8/1	51N Time dial(1-10 *20)/delay byte(0-10 * 20) IEC Curve -51N Time Multiplier (.05-1.00 *200)
8/2	50N-1 Curve Select byte (Type III or Recloser)
8/3	50N-1 Pickup X byte (0.5-20 *10)
9/1	50N-1 Timedial/delay high byte (1-10 *10, 0-9.99 *100) IEC Curve -50N-1 Time Multiplier (.05-1.00 *200)
9/2	50N-1 Timedial/delay low byte
9/3	50N-2 Select byte (0 = Disable, 1 = Enable) Sensitive Earth Model (0=Disable, 1=Standard, 2=SEF, 3=Directional SEF)
10/1	50N-2 Pickup X byte (0.5-20 *10)

10/2	50N-2 Timedelay high byte (0-9.99 *100) SEF or Directional SEF Selects - 50N-2 Time Delay (0.5 to 180.0)*200
10/3	50N-2 Timedelay low byte
11/1	50N-3 Select byte (0=Disable, 1=Enable)
11/2	50N-3 Pickup X byte (0.5-20 *10)
11/3	79 Reset Time byte (3-200)
12/1	79-1 Select high byte (Lockout Type)
12/2	79-1 Select low byte (Enable Type)
12/3	79-1 Open Interval Time high byte (0.1 - 200 *10, 2001 = Lockout) Sensitive Earth Model (0.1 to 1800 *10, 18001=Lockout)
13/1	79-1 Open Interval Time low byte
13/2	79-2 Select high byte (Lockout Type)
13/3	79-2 Select low byte (Enable Type)
14/1	79-2 Open Interval Time high byte (0.1 - 200 *10, 2001 = Lockout) Sensitive Earth Model (0.1 to 1800 *10, 18001=Lockout)
14/2	79-2 Open Interval Time low byte
14/3	79-3 Select high byte (Lockout)
15/1	79-3 Select low byte (Enable)
15/2	79-3 Open Interval Time high byte (0.1 - 200 *10, 2001 = Lockout) Sensitive Earth Model (0.1 to 1800 *10, 18001=Lockout)
15/3	79-3 Open Interval Time low byte
16/1	79-4 Select high byte (Lockout Type)
16/2	79-4 Select low byte (Enable Type)
16/3	79-4 Open Interval Time high byte (0.1 - 200 *10, 2001 = Lockout) Sensitive Earth Model (0.1 to 1800 *10, 18001=Lockout)
17/1	79-4 Open Interval Time low byte
17/2	79-5 Select high byte (Lockout Type)
17/3	79-5 Select low byte (Enable Type)
18/1	79-5 Open Interval Time high byte (always lockout)
18/2	79-5 Open Interval Time low byte
18/3	79 Cutout Time byte (1 -201) (201 = Disable)
19/1	Cold Load Time byte (1 -254) (255 = Disable)
19/2	2 Phase Voting byte (0=Disable, 1=Enable)
19/3	67P Select byte (0=Disable, 1=Enable, 2=Lockout)
20/1	67P Curve Select byte (Type I)
20/2	67P Pickup Amps byte (1-12Amp *10, 0.2-2.4Amp *50)
20/3	67P Time dial(1-10 *20)/delay(0-10 * 20) byte IEC Curve -67P Time Multiplier (.05-1.00 *200)
21/1	67P Torque Angle byte (0-355 /5)
21/2	67N Select byte (0=Disable, 1=Enable Neg Polar, 2=Enable Zero Polar, 3=Lockout Neg Polar, 4=Lockout Zero Polar) Sensitive Earth Model (0=Disable, 1=Enable-Neg Sequence, 2=Lockout-Neg Sequence, 5=Enable-Pos Sequence, 6=Lockout Pos Sequence)
21/3	67N Curve Select byte (Type I)
22/1	67N Pickup Amps byte (1-12Amp *10, 0.2-2.4Amp *50)
22/2	67N Time dial(1-10 *20)/delay(0-10 * 20) byte IEC Curve -67N Time Multiplier (.05-1.00 *200)
22/3	67N Torque Angle byte (0-355 /5)
23/1	81 Select byte (0=Disable,1=81-1, 2=81-2, 3=Special)
23/2	81s-1 Pickup Frequency high byte (60hz: 56-64 *100, 6401=Disable, 50hz: 46-54 *100, 5401=Disable)
23/3	81s-1 Pickup Frequency low byte
24/1	81s-1 Timedelay high byte (0.08-9.98 *100)
24/2	81s-1 Timedelay low byte
24/3	81r-1 Pickup Frequency high byte (60hz: 56-64 *100, 6401=Disable 50hz: 46-54 *100, 5401=Disable)
25/1	81r-1 Pickup Frequency low byte
25/2	81r-1 Timedelay high byte (0-999)
25/3	81r-1 Timedelay low byte

26/1	81v Voltage Block high byte (40-200)
26/2	81v Voltage Block low byte
26/3	27 Select byte (0=Disable, 1=Enable)
27/1	27 Pickup Voltage high byte (10-200)
27/2	27 Pickup Voltage low byte
27/3	27 Timedelay byte (0-60)
28/1	79v Select byte (0=Disable, 1=Enable)
28/2	79v Pickup Voltage high byte (10-200)
28/3	79v Pickup Voltage low byte
29/1	79v Timedelay byte (4-200)
29/2	59 Select byte (0=Disable, 1=Enable)
29/3	59 Pickup Voltage high byte (70-250)
30/1	59 Pickup Voltage low byte
30/2	59 Timedelay byte (0-60)
30/3	51 P Minimum Response (0 - 60 cycles)
31/1	51 N Minimum Response (0 - 60 cycles)
31/2	50 P-1 Minimum Response (0 - 60 cycles)
31/3	50 N-1 Minimum Response (0 - 60 cycles)
32/1	Unit Configuration byte bit 0 : neutral tap range if bit 7 is 0 use range: 0=1-12A, 1=0.2-2.4A if bit 7 is 1 use range: 0=0.5-6.0A, 1=0.2-2.4A bit 1 : phase tap range if bit 7 is 0 use range: 0=1-12A, 1=0.2-2.4A if bit 7 is 1 use range: 0=1-12A, 1=0.5-6.0A bit 2 : frequency range (0=60Hz, 1=50Hz) bit 3 : cold load timer mode (0=seconds, 1=minutes) bit 4 : user definable curves (0=disabled, 1=enabled) bit 5 : recloser curves (0=disabled, 1=enabled) bit 6 : Version Select (0=ANSI, 1=IEC) bit 7 : phase & neutral tap ranges (0=1-12 and 0.2-2.4, 1=1-12, 0.2-2.4 and 0.5-6.0)
32/2	81s-2 Pickup Frequency high byte (60hz: 56-64 *100, 6401=Disable 50hz: 46-54 *100, 5401=Disable)
32/3	81s-2 Pickup Frequency low byte
33/1	81s-2 Timedelay high byte (0.08-9.98 *100)
33/2	81s-2 Timedelay low byte
33/3	81r-2 Pickup Frequency high byte (60hz: 56-64 *100, 6401=Disable 50hz: 46-54 *100, 5401=Disable)
34/1	81r-2 Pickup Frequency low byte
34/2	81r-2 Timedelay high byte (0-999)
34/3	81r-2 Timedelay low byte
35/1	Sensitive Earth Model - SEF Torque Angle (0-355 /5)
35/2	Sensitive Earth Model - SEF 50N-2 Pickup mA high byte (.005-.060 *2000)
35/3	SEF 50N-2 Pickup mA low byte
36/1	Sensitive Earth Model- Neutral Cold Load (1-254)(255= Disable)
36/2	Checksum high byte
36/3	Checksum low byte

5.4.9 Transmit Configuration Settings (3 4 11)

Low byte consists of bits 0 through 7.

High byte consists of bits 8 through 15.

<u>Msg byte</u>	<u>Definition</u>
1/1	Relay Status (see command 3 4 1, msg 1/1)
1/2	Command + Subcommand = 0x4b
1/3	Total Number of Messages = 23
2/1	Phase CT Ratio high byte (1-999 DPU2000, 1-2000 DPU2000R/1500R)
2/2	Phase CT Ratio low byte

2/3	Neutral CT Ratio high byte (1-999 DPU2000, 1-2000 DPU2000R)
3/1	Neutral CT Ratio low byte
3/2	VT Ratio high byte (1-999 DPU2000, 1-2000 DPU2000R/1500R)
3/3	VT Ratio low byte
4/1	VT Connection high byte (0=69V Wye,1=120V Wye, 2=120V Delta, 3=208V Delta, 4=69V Wye 3V0 I, 5=120V Wye 3V0 I)
4/2	VT Connection low byte
4/3	Positive Sequence Reactance high byte (1-4 *1000)
5/1	Positive Sequence Reactance low byte
5/2	Positive Sequence Resistance high byte (1-4 *1000)
5/3	Positive Sequence Resistance low byte
6/1	Zero Sequence Reactance high byte (1-4 *1000)
6/2	Zero Sequence Reactance low byte
6/3	Zero Sequence Resistance high byte (1-4 *1000)
7/1	Zero Sequence Resistance low byte
7/2	Distance in Miles high byte (0.1-50 *10) IEC Version (0.1-200 *10) km
7/3	Distance in Miles low byte
8/1	Trip Failure Time high byte (5-60)
8/2	Trip Failure Time low byte
8/3	Close Failure Time high byte (18-999)
9/1	Close Failure Time low byte
9/2	Phase Rotation high byte (0=ABC, 1=ACB)
9/3	Phase Rotation low byte
10/1	Configuration Flag high byte
10/2	Configuration Flag low byte bit 0: Protection Mode (0=Fund, 1=RMS) bit 1: Reset Mode (0=Instant, 1=Delayed) bit 2: Zone Sequence (0=Disabled, 1=Enabled) bit 3: Target Display Mode (0=Last, 1=All) bit 4: Local Edit (0=Disabled, 1=Enabled) bit 5: Remote Edit (0=Disabled, 1=Enabled) bit 6: WHr/VarHr Mtr Mode (0=KWHr, 1=MWHr) bit 7: LCD Light (0=Timer, 1=On) bit 8: Multi Device Trip (0=Disabled, 1=Enabled) bit 9: VCN Special Mode (0=Normal, 1=Inverted) bit10: Cold Load Timer Mode(0=Seconds, 1=Minutes) bit11: IEC Mode Bit, Not supported as of V1.70, Reserved bit 12: 79V Timer Mode(0= sec., 1= min.) bit 13: Voltage Display Mode(0= Vln, 1= VII) bit 14: Password Viewer (0= Disable, 1= Enable)
10/3	ALT 1 Setting Enable high byte(0=Disable, 1=Enable)
11/1	ALT 1 Setting Enable low byte
11/2	ALT 2 Setting Enable high byte(0=Disable, 1=Enable)
11/3	ALT 2 Setting Enable low byte
12/1	Demand Time Constant high byte
12/2	Demand Time Constant low byte (0=5 min, 1=15 min, 2=30 min, 3=60 min)
12/3	Sensitive Earth CT Ratio high byte (1-2000), (DPU2000R/1500R)
13/1	Sensitive Earth CT Ratio low byte
13/2-18/1	Unit Name character 1-15
18/2	Spare
18/3	Sensitive Earth V0 PT Ratio high byte (1-2000) , (DPU2000R/1500R)
19/1	Sensitive Earth V0 PT Ratio low byte
19/2	Spare
19/3	Spare
20/1	LCD Contrast Adjustment high byte(0-63)
20/2	LCD Contrast Adjustment low byte
20/3	Relay Password character 1

21/1	Relay Password character 2
21/2	Relay Password character 3
21/3	Relay Password character 4
22/1	Test Password character 1
22/2	Test Password character 2
22/3	Test Password character 3
23/1	Test Password character 4
23/2	Checksum high byte
23/3	Checksum low byte

5.4.10 Transmit Counter Settings (3 4 12)

NOTE: This command is used in DPU2000 versions prior to CPU V1.41.
 Low byte consists of bits 0 through 7.
 High byte consists of bits 8 through 15.

<u>Msg byte</u>	<u>Definition</u>
1/1	Relay Status (see command 3 4 1, msg 1/1)
1/2	Command + Subcommand = 0x4c
1/3	Total Number of Messages = 9
2/1	KSI Sum A Counter high byte(0-9999)
2/2	KSI Sum A Counter low byte
2/3	KSI Sum B Counter high byte(0-9999)
3/1	KSI Sum B Counter low byte
3/2	KSI Sum C Counter high byte(0-9999)
3/3	KSI Sum C Counter low byte
4/1	Overcurrent Trip Counter high byte(0-9999)
4/2	Ovecurrent Trip Counter low byte
4/3	Breaker Operations Counter high byte(0-9999)
5/1	Breaker Operations Counter low byte
5/2	Reclose Counter 1 high byte(0-9999)
5/3	Reclose Counter 1 low byte
6/1	1st Reclose Counter high byte(0-9999)
6/2	1st Reclose Counter low byte
6/3	2nd Reclose Counter high byte(0-9999)
7/1	2nd Reclose Counter low byte
7/2	3rd Reclose Counter high byte(0-9999)
7/3	3rd Reclose Counter low byte
8/1	4th Reclose Counter high byte(0-9999)
8/2	4th Reclose Counter low byte
8/3	Reclose Counter 2 high byte(0-9999)
9/1	Reclose Counter 2 low byte
9/2	Checksum high byte
9/3	Checksum low byte

5.4.11 Transmit Alarm Settings (3 4 13)

Low byte consists of bits 0 through 7.
 High byte consists of bits 8 through 15.

<u>Msg byte</u>	<u>Definition</u>
1/1	Relay Status (see command 3 4 1, msg 1/1)
1/2	Command + Subcommand = 0x4d
1/3	Total Number of Messages = 13
2/1	KSI Summation Alarm Threshold high byte (1-9999,10000=Disables)
2/2	KSI Summation Alarm Threshold low byte
2/3	Overcurrent Trip Counter Alarm high byte (1-9999,10000=Disables)
3/1	Overcurrent Trip Counter Alarm Threshold low byte
3/2	Reclosure Counter 1 Alarm high byte (1-9999,10000=Disables)
3/3	Reclosure Counter 1 Alarm Threshold low byte
4/1	Phase Demand Alarm high byte (1-9999,10000=Disables)

4/2	Phase Demand Alarm low byte
4/3	Neutral Demand Alarm high byte (1-9999,10000=Disables)
5/1	Neutral Demand Alarm low byte
5/2	Low PF Alarm high byte (0.5-1.0 *100, 101=Disables)
5/3	Low PF Alarm low byte
6/1	High PF Alarm high byte (0.5-1.0 *100, 101=Disables)
6/2	High Pf Alarm low byte
6/3	Reclosure Counter 2 Alarm high byte (1-9999,10000=Disables)
7/1	Reclosure Counter 2 Alarm Threshold low byte
7/2	3 Phase kVAR Alarm high byte (10-99990 /10,10000=Disables)
7/3	3 Phase kVAR Alarm Threshold low byte
8/1	Load Current Alarm high byte (1-9999,10000=Disables)
8/2	Load Current Alarm low byte
8/3	Positive kVAR Alarm high byte (10-99990 /10,10000=Disable)
9/1	Positive kVAR Alarm low byte
9/2	Negative kVAR Alarm high byte (10-99990 /10,10000=Disable)
9/3	Negative kVAR Alarm high byte
10/1	Pos Watt Alarm 1 high byte (1-9999, 10000=Disable)
10/2	Pos Watt Alarm 1 low byte
10/3	Pos Watt Alarm 2 high byte (1-9999, 10000=Disable)
11/1	Pos Watt Alarm 2 low byte
11/2	Spare
11/3	Spare
12/1	Spare
12/2	Spare
12/3	Spare
13/1	Spare
13/2	Checksum high byte
13/3	Checksum low byte

NOTE: Positive Watt Alarm 1 and Positive Watt Alarm 2 units are displayed in either KWhr or MWhr according to bit 6 of Configuration Flag (Command 3 4 11, message 10/2). If bit is set to one, use MWhr, if bit is zero, use KWhr.

5.4.12 Transmit Real Time Clock (3 4 14)

<u>Msg byte</u>	<u>Definition</u>
1/1	Relay Status (see command 3 4 1, msg 1/1)
1/2	Command + Subcommand = 0x4e
1/3	Total Number of Messages = 4
2/1	Hours byte (0-23)
2/2	Minutes byte (0-59)
2/3	Seconds byte (0-59)
3/1	Day byte (0-31)(0=Clock shutdown)
3/2	Month byte (1-12)
3/3	Year byte (0-99)
4/1	Spare
4/2	Checksum high byte
4/3	Checksum low byte

5.4.13 Transmit Programmable Output Delays (3 4 15)

<u>Msg Byte</u>	<u>Definition</u>
1/1	Relay Status (see command 3 4 1, msg 1/1)
1/2	Command + Subcommand = 0x4f
1/3	Total Number of Messages = 8
2/1	OUT 6 delay high byte (0.00-60, DPU2000 and 0.00-250, DPU2000R/1500R, *100)
2/2	OUT 6 delay low byte
2/3	OUT 4 delay high byte (0.00-60, DPU2000 and 0.00-250, DPU2000R/1500R, *100)
3/1	OUT 4 delay low byte
3/2	OUT 5 delay high byte (0.00-60, DPU2000 and 0.00-250, DPU2000R/1500R, *100)
3/3	OUT 5 delay low byte

4/1	OUT 3 delay high byte (0.00-60, DPU2000 and 0.00-250, DPU2000R/1500R, *100)
4/2	OUT 3 delay low byte
4/3	OUT 2 delay high byte (0.00-60, DPU2000 and 0.00-250, DPU2000R/1500R, *100)
5/1	OUT 2 delay low byte
5/2	OUT 1 delay high byte (0.00-60, DPU2000 and 0.00-250, DPU2000R/1500R, *100)
5/3	OUT 1 delay low byte
6/1	OUT 7 delay high byte (0.00-60, DPU2000)
6/2	OUT 7 delay low byte
6/3	OUT 8 delay high byte (0.00-60, DPU2000)
7/1	OUT 8 delay low byte
7/2	Spare
7/3	Spare
8/1	Spare
8/2	Checksum high byte
8/3	Checksum low byte

5.5 Transmit Buffer "35N" Commands (3 5 n)

When n=0 then the previous Receive Number command would define the number "N". Otherwise this command would take the number "N" defined by the subcmd field (1 - 15).

<u>N</u>	<u>Definition</u>
0	Repeat last command
1	Show Load Metered Data
2	Show Demand Metered Data
3	Show Peak Demand Metered Data
5	Show Load Meter Data
6	Show Average Load Current
7	Show Quick 3-Phase Meter Data
8	Send First Fault Record
9	Send Next Fault Record
10	Send First Fault Summary Record
11	Send Next Fault Summary Record
12	Send First Operation Record
13	Send Next Operation Record
14	Breaker Status (including contact inputs)
15	Power Fail Data

5.5.1 Show Load Metered Data (3 5 1)

<u>Msg byte</u>	<u>Definition</u>
1/1	Relay Status Command (see command 3 4 1, msg 1/1)
1/2	Command + Subcommand = 0x51
1/3	Total Number of Messages = 35
2/1	Aux. Status byte Bit 0 : 0 = Wye, 1 = Delta Bit 1 : 0 = kWhr 1 = Mwhr Bit 2 : 0= V(line-neutral) , 1= V(line-line)
2/2	IA Hi byte (Load Currents)
2/3	IA Lo byte
3/1	IA Angle Hi byte
3/2	IA Angle Lo byte
3/3	IB Hi byte
4/1	IB Lo byte
4/2	IB Angle Hi byte
4/3	IB Angle Lo byte
5/1	IC Hi byte
5/2	IC Lo byte
5/3	IC Angle Hi byte
6/1	IC Angle Lo byte

6/2	IN Hi byte
6/3	IN Lo byte
7/1	IN Angle Hi byte
7/2	IN Angle Lo byte
7/3	KVan/KVab (Mag) Hi byte (*100)
8/1	KVan/KVab (Mag) Lo byte
8/2	KVan/KVab (Ang) Hi byte
8/3	KVan/KVab (Ang) Lo byte
9/1	KVbn/KVbc (Mag) Hi byte (*100)
9/2	KVbn/KVbc (Mag) Lo byte
9/3	KVbn/KVbc (Ang) Hi byte
10/1	KVbn/KVbc (Ang) Lo byte
10/2	KVcn/KVca (Mag) Hi byte (*100)
10/3	KVcn/KVca (Mag) Lo byte
11/1	KVcn/KVca (Ang) Hi byte
11/2	KVcn/KVca (Ang) Lo byte
11/3	KWan Hi byte
12/1	KWan Mid byte
12/2	KWan Lo byte
12/3	KWbn Hi byte
13/1	KWbn Mid byte
13/2	KWbn Lo byte
13/3	KWcn Hi byte
14/1	KWcn Mid byte
14/2	KWcn Lo byte
14/3	KW3 Hi byte
15/1	KW3 Mid byte
15/2	KW3 Lo byte
15/3	KVARan Hi byte
16/1	KVARan Mid byte
16/2	KVARan Lo byte
16/3	KVARbn Hi byte
17/1	KVARbn Mid byte
17/2	KVARbn Lo byte
17/3	KVARcn Hi byte
18/1	KVARcn Mid byte
18/2	KVARcn Lo byte
18/3	KVAR3 Hi byte
19/1	KVAR3 Mid byte
19/2	KVAR3 Lo byte
19/3	KWHra Hi byte
20/1	KWHra Mid byte
20/2	KWHra Lo byte
20/3	KWHrb Hi byte
21/1	KWHrb Mid byte
21/2	KWHrb Lo byte
21/3	KWHrc Hi byte
22/1	KWHrc Mid byte
22/2	KWHrc Lo byte
22/3	KWHr3 Hi byte
23/1	KWHr3 Mid byte
23/2	KWHr3 Lo byte
23/3	KVARHra Hi byte
24/1	KVARHra Mid byte
24/2	KVARHra Lo byte
24/3	KVARHrb Hi byte
25/1	KVARHrb Mid byte
25/2	KVARHrb Lo byte
25/3	KVARHrc Hi byte

26/1	KVARHrc Mid byte
26/2	KVARHrc Lo byte
26/3	KVARHr3 Hi byte
27/1	KVARHr3 Mid byte
27/2	KVARHr3 Lo byte
27/3	I0 Hi byte
28/1	I0 Lo byte
28/2	I0 Angle Hi byte
28/3	I0 Angle Lo byte
29/1	I1 Hi byte
29/2	I1 Lo byte
29/3	I1 Angle Hi byte
30/1	I1 Angle Lo byte
30/2	I2 Hi byte
30/3	I2 Lo byte
31/1	I2 Angle Hi byte
31/2	I2 Angle Lo byte
31/3	KV1 Hi byte (*100)
32/1	KV1 Lo byte
32/2	KV1 Angle Hi byte
32/3	KV1 Angle Lo byte
33/1	KV2 Hi byte (*100)
33/2	KV2 Lo byte
33/3	KV2 Angle Hi byte
34/1	KV2 Angle Lo byte
34/2	Frequency Hi byte (*100)
34/3	Frequency Lo byte
35/1	Power Factor
	bit 0-6 : Power factor value (*100)
	bit 7 : 0 = Leading, 1 = Lagging
35/2	Spare
35/3	Spare

5.5.2 Show Demand Metered Data (3 5 2)

<u>Msg byte</u>	<u>Definition</u>
1/1	Relay Status (see command 3 4 1, msg 1/1)
1/2	Command + Subcommand = 0x52
1/3	Total Number of Messages = 12
2/1	Aux. Status byte (see command 3 5 1, msg 2/1)
2/2	Demand Ia Hi byte (Load Currents)
2/3	Demand Ia Lo byte
3/1	Demand Ib Hi byte
3/2	Demand Ib Lo byte
3/3	Demand Ic Hi byte
4/1	Demand Ic Lo byte
4/2	Demand In Hi byte
4/3	Demand In Lo byte
5/1	Demand KWan Hi byte
5/2	Demand KWan Mid byte
5/3	Demand KWan Lo byte
6/1	Demand KWbn Hi byte
6/2	Demand KWbn Mid byte
6/3	Demand KWbn Lo byte
7/1	Demand KWcn Hi byte
7/2	Demand KWcn Mid byte
7/3	Demand KWcn Lo byte
8/1	Demand KW3 Hi byte
8/2	Demand KW3 Mid byte
8/3	Demand KW3 Lo byte

9/1	Demand KVARan Hi byte
9/2	Demand KVARan Mid byte
9/3	Demand KVARan Lo byte
10/1	Demand KVARbn Hi byte
10/2	Demand KVARbn Mid byte
10/3	Demand KVARbn Lo byte
11/1	Demand KVARcn Hi byte
11/2	Demand KVARcn Mid byte
11/3	Demand KVARcn Lo byte
12/1	Demand KVAR3 Hi byte
12/2	Demand KVAR3 Mid byte
12/3	Demand KVAR3 Lo byte

5.5.3 Show Maximum Peak Demand Metered Data (3 5 3)

<u>Msg byte</u>	<u>Definition</u>
1/1	Relay Status (see command 3 4 1, msg 1/1)
2	Command + Subcommand = 0x53
3	Total Number of Messages = 32
2/1	Aux. Status byte (see command 3 5 1, msg 2/1)
2	Peak Dem Ia Hi byte (Load Currents)
3	Peak Dem Ia Lo byte
3/1	Peak Dem Ia time yy
2	Peak Dem Ia time mn
3	Peak Dem Ia time dd
4/1	Peak Dem Ia time hh
2	Peak Dem Ia time mm
3	Peak Dem Ib Hi byte
5/1	Peak Dem Ib Lo byte
2	Peak Dem Ib time yy
3	Peak Dem Ib time mn
6/1	Peak Dem Ib time dd
2	Peak Dem Ib time hh
3	Peak Dem Ib time mm
7/1	Peak Dem Ic Hi byte
2	Peak Dem Ic Lo byte
3	Peak Dem Ic time yy
8/1	Peak Dem Ic time mn
2	Peak Dem Ic time dd
3	Peak Dem Ic time hh
9/1	Peak Dem Ic time mm
2	Peak Dem In Hi byte
3	Peak Dem In Lo byte
10/1	Peak Dem In time yy
2	Peak Dem In time mn
3	Peak Dem In time dd
11/1	Peak Dem In time hh
2	Peak Dem In time mm
3	Peak Dem KWan Hi byte
12/1	Peak Dem KWan Mid byte
2	Peak Dem KWan Lo byte
3	Peak Dem KWan time yy
13/1	Peak Dem KWan time mn
2	Peak Dem KWan time dd
3	Peak Dem KWan time hh
14/1	Peak Dem KWan time mm
2	Peak Dem KWbn Hi byte
3	Peak Dem KWbn Mid byte
15/1	Peak Dem KWbn Lo byte
2	Peak Dem KWbn time yy

3	Peak Dem KWbn time mn
16/1	Peak Dem KWbn time dd
2	Peak Dem KWbn time hh
3	Peak Dem KWbn time mm
17/1	Peak Dem KWcn Hi byte
2	Peak Dem KWcn Mid byte
3	Peak Dem KWcn Lo byte
18/1	Peak Dem KWcn time yy
2	Peak Dem KWcn time mn
3	Peak Dem KWcn time dd
19/1	Peak Dem KWcn time hh
2	Peak Dem KWcn time mm
3	Peak Dem KW3 Hi byte
20/1	Peak Dem KW3 Mid byte
2	Peak Dem KW3 Lo byte
3	Peak Dem KW3 time yy
21/1	Peak Dem KW3 time mn
2	Peak Dem KW3 time dd
3	Peak Dem KW3 time hh
22/1	Peak Dem KW3 time mm
2	Peak Dem KVARan Hi byte
3	Peak Dem KVARan Mid byte
23/1	Peak Dem KVARan Lo byte
2	Peak Dem KVARan time yy
3	Peak Dem KVARan time mn
24/1	Peak Dem KVARan time dd
2	Peak Dem KVARan time hh
3	Peak Dem KVARan time mm
25/1	Peak Dem KVARbn Hi byte
2	Peak Dem KVARbn Mid byte
3	Peak Dem KVARbn Lo byte
26/1	Peak Dem KVARbn time yy
2	Peak Dem KVARbn time mn
3	Peak Dem KVARbn time dd
27/1	Peak Dem KVARbn time hh
2	Peak Dem KVARbn time mm
3	Peak Dem KVARcn Hi byte
28/1	Peak Dem KVARcn Mid byte
2	Peak Dem KVARcn Lo byte
3	Peak Dem KVARcn time yy
29/1	Peak Dem KVARcn time mn
2	Peak Dem KVARcn time dd
3	Peak Dem KVARcn time hh
30/1	Peak Dem KVARcn time mm
2	Peak Dem KVAR3 Hi byte
3	Peak Dem KVAR3 Mid byte
31/1	Peak Dem KVAR3 Lo byte
2	Peak Dem KVAR3 time yy
3	Peak Dem KVAR3 time mn
32/1	Peak Dem KVAR3 time dd
2	Peak Dem KVAR3 time hh
3	Peak Dem KVAR3 time mm

5.5.4 Show Minimum Peak Demand Metered Data (3 5 4)

Substitute minimum peak for maximum peak and this command is the same as the Show Maximum Peak Demand Metered Data command (3 5 3), except for byte 2 of message 1. The command + subcommand (Msg 1/byte 2) is 0x54, not 0x53.

5.5.5 Show Load Metered Data (3 5 5)

<u>Msg byte</u>	<u>Definition</u>
1/1	Relay Status (see command 3 4 1, msg 1/1)
1/2	Command + Subcommand = 0x55
1/3	Total Number of Messages = 4
2/1	Aux. Status byte (see command 3 5 1, msg 2/1)
2/2	a high byte (Load Currents)
2/3	Ia (low byte)
3/1	Ib (high byte)
3/2	Ib (low byte)
3/3	Ic (high byte)
4/1	Ic (low byte)
4/2	In (high byte)
4/3	In (low byte)

5.5.6 Show Average Load Current (3 5 6)

<u>Msg byte</u>	<u>Definition</u>
1/1	Relay Status (see command 3 4 1, msg 1/1)
1/2	Command + Subcommand = 0x56
1/3	Total Number of Messages = 2
2/1	Aux. Status byte (see command 3 5 1, msg 2/1)
2/2	Iavg (high byte)
2/3	Iavg (low byte)

5.5.7 Show Quick 3-Phase Meter (3 5 7)

<u>Msg byte</u>	<u>Definition</u>
1/1	Relay Status (see command 3 4 1, msg 1/1)
1/2	Command + Subcommand = 0x57
1/3	Total Number of Messages = 4
2/1	Aux. Status (see command 3 5 1, msg 2/1)
2/2	Iavg (high byte)
2/3	Iavg (low byte)
3/1	KW3 Hi byte
3/2	KW3 Mid byte
3/3	KW3 Lo byte
4/1	KVAR3 Hi byte
4/2	KVAR3 Mid byte
4/3	KVAR3 Lo byte

5.5.8 Send First Fault Record (3 5 8)

<u>Message Number</u>	<u>Definitions</u>
00	51P
01	51N
02	50P-1
03	50N-1
04	50P-2
05	50N-2
06	50P-3
07	50N-3
08	67P (DPU2000 and DPU2000R)
09	67N (DPU2000 and DPU2000R)
10	46
11	81 (DPU2000 and DPU2000R)
12	Zone Step
13	ECI-1
14	ECI-2
15	SEF (SE models)

<u>Msg byte</u>	<u>Definition</u>
1/1	Relay Status (see command 3 4 1, msg 1/1)
1/2	Command + Subcommand = 0x58
1/3	Total Number of Messages = 27
2/1	Fault Type (element)
2/2	Active Set and Reclosing Sequence byte bit 0-3 : 1=1, 2=2, 3=3, 4=4, 5=L bit 4-7 : 1=Prim, 2=Alt1, 4=Alt2
2/3	Fault Number (high byte)
3/1	Fault Number (low byte)
3/2	Year
3/3	Month
4/1	Day
4/2	Hours or Most significant high byte millisec time since midnight
4/3	Minutes or Most significant low byte millisec time since midnight
5/1	Seconds or Least significant high byte millisec time since midnight
5/2	Hundredths of seconds or Least significant low byte millisec time since midnight, see note below.
5/3	IA Hi byte (/i_scale see msg 8/2)
6/1	IA Lo byte
6/2	IB Hi byte (/i_scale see msg 8/2)
6/3	IB Lo byte
7/1	IC Hi byte (/i_scale see msg 8/2)
7/2	IC Lo byte
7/3	IN Hi byte (/i_scale see msg 8/2)
8/1	IN Lo byte
8/2	Current Scale (0,1 : i_scale=1, 10 : i_scale=10)
8/3	Spare
9/1	Ia Angle (Hi byte)
9/2	Ia Angle (Lo byte)
9/3	Ib Angle (Hi byte)
10/1	Ib Angle (Lo byte)
10/2	Ic Angle (Hi byte)
10/3	Ic Angle (Lo byte)
11/1	In Angle (Hi byte)
11/2	In Angle (Lo byte)
11/3	Zero Seq I (Mag) Hi byte (/i_scale see msg 8/2)
12/1	Zero Seq I (Mag) Lo byte
12/2	Pos Seq I (Mag) Hi byte (/i_scale see msg 8/2)
12/3	Pos Seq I (Mag) Lo byte
13/1	Neg Seq I (Mag) Hi byte (/i_scale see msg 8/2)
13/2	Neg Seq I (Mag) Lo byte
13/3	Zero Seq I (Ang) Hi byte
14/1	Zero Seq I (Ang) Lo byte
14/2	Pos Seq I (Ang) Hi byte
14/3	Pos Seq I (Ang) Lo byte
15/1	Neg Seq I (Ang) Hi byte
15/2	Neg Seq I (Ang) Lo byte
15/3	KVab/KVan (Mag) Hi byte (*100)
16/1	KVab/KVan (Mag) Lo byte (*100)
16/2	KVbc/KVbn (Mag) Hi byte (*100)
16/3	KVbc/KVbn (Mag) Lo byte (*100)
17/1	KVca/KVcn (Mag) Hi byte (*100)
17/2	KVca/KVcn (Mag) Lo byte (*100)
17/3	Vab/Van (Ang) Hi byte
18/1	Vab/Van (Ang) Lo byte
18/2	Vbc/Vbn (Ang) Hi byte
18/3	Vbc/Vbn (Ang) Lo byte

19/1	Vca/Vcn (Ang) Hi byte
19/2	Vca/Vcn (Ang) Lo byte
19/3	Pos Seq KV (Mag) Hi byte (*100)
20/1	Pos Seq KV (Mag) Lo byte
20/2	Neg Seq KV (Mag) Hi byte (*100)
20/3	Neg Seq KV (Mag) Lo byte
21/1	Pos Seq V (Ang) Hi byte
21/2	Pos Seq V (Ang) Lo byte
21/3	Neg Seq V (Ang) Hi byte
22/1	Neg Seq V (Ang) Lo byte
22/2	Fault location (high byte) (*10)
22/3	Fault location (low byte)
23/1	Fault impedance, real part (high byte) (*1000)
23/2	Fault impedance, real part
23/3	Fault impedance, real part
24/1	Fault impedance, real part (low byte)
24/2	Breaker Operate Time (high byte) (*1000)
24/3	Breaker Operate Time
25/1	Breaker Operate Time
25/2	Breaker Operate Time (low byte)
25/3	Relay Operate Time (high byte) (*1000)
26/1	Relay Operate Time
26/2	Relay Operate Time
26/3	Relay Operate Time (low byte)
27/1	Record Status (high byte)
27/2	Record Status (low byte)
	bit 0 : 0 = Wye Connection , 1 = Delta Connection
	bit 1 : 0 = Fault , 1 = Event Capture
27/3	Spare

If no fault data entry is present then send all 0s for 2/1 through 27/3.

NOTE: If IRIG is enabled using Enable-mmm option in Communications Command, then the most significant bit of the hour byte will be set to indicate that the four time bytes (Hours, Minutes, Seconds, and Hundreths of Seconds should be combined to form a long value indicating the time in milliseconds since midnight.

5.5.9 Send Next Fault Record (3 5 9)

Same format as (3 5 8) except Msg 1/2 = 0x59.

5.5.10 Send First Fault Summary Record (3 5 10)

<u>Msg byte</u>	<u>Definition</u>
1/1	Relay Status (see command 3 4 1, msg 1/1)
1/2	Command + Subcommand = 0x5a
1/3	Total Number of Messages = 8
2/1	Fault Type (element)
2/2	Active Set and Reclosing Sequence byte
	bit 0-3 : 1=Prim, 2=Alt1, 4=Alt2
	bit 4-7 : 1=1, 2=2, 3=3, 4=4, 5=L
2/3	Fault Number (high byte)
3/1	Fault Number (low byte)
3/2	Year
3/3	Month
4/1	Day
4/2	Hours or Most significant high byte millisec time since midnight
4/3	Minutes or Most significant low byte millisec time since midnight
5/1	Seconds or Least significant high byte millisec time since midnight
5/2	Hundredths of seconds or Least significant low byte millisec time since midnight, see note in command 3 5 8.

5/3	IA Hi byte (/i_scale see msg 8/2)
6/1	IA Lo byte
6/2	IB Hi byte (/i_scale see msg 8/2)
6/3	IB Lo byte
7/1	IC Hi byte (/i_scale see msg 8/2)
7/2	IC Lo byte
7/3	IN Hi byte (/i_scale see msg 8/2)
8/1	IN Lo byte
8/2	Current Scale (0,1 : i_scale=1, 10 : i_scale=10)
8/3	Spare

If no fault data entry is present then send all 0s for 2/1 through 8/3.

5.5.11 Send Next Fault Summary Record (3 5 11)

Same format as (3 5 10) except Msg 1/2 = 0x5b.

5.5.12 Send First Operations Record (3 5 12)

<u>Message Number</u>	<u>Definitions</u>
00	51P Trip
01	51N Trip
02	50P-1 Trip
03	50N-1 Trip
04	50P-2 Trip
05	50N-2 Trip
06	50P-3 Trip
07	50N-3 Trip
08	67P Trip (DPU2000 and DPU2000R)
09	67N Trip (DPU2000 and DPU2000R)
10	46 Trip
11	27-1P Alarm
12	59 Alarm (DPU2000 and DPU2000R)
13	79V Block
14	81S-1 Trip (DPU2000 and DPU2000R)
15	81R-1 Restore (DPU2000 and DPU2000R)
16	81V Block (DPU2000 and DPU2000R)
17	TOC Pickup-No Trip
18	27-3P Alarm
20	External Trip
21	External Close
22	Breaker Opened
23	Breaker Closed
24	Open Trip Contact
25	Recloser Lockout
26	Direct Trip
27	Direct Close
28	MDT Close
29	External Trip and ARC
30	Reclose Initiated
31	CB Failed to Trip
32	CB Failed to Close
33	CB Pops Open
34	CB Pops Closed
35	CB State Unknown
36	CB Stuck Closed
37	Ext. Trip CB Stuck
38	Springs Discharged
40	Manual Trip

41	Manual Close
42	Ground TC Enabled
43	Ground TC Disabled
44	Phase TC Enabled
45	Phase TC Disabled
46	Primary Set Active
47	Alt 1 Set Active
48	Alt 2 Set Active
49	Zone Step
50	Recloser Enabled
51	Recloser Disabled
52	Zone Sequence Enabled
53	Zone Sequence Disabled
54	50P/N-1 Disabled
55	50P/N-2 Disabled
56	50P/N-3 Disabled
57	50P/N-1 Enabled
58	50P/N-2 Enabled
59	50P/N-3 Enabled
60	81S-2 Trip (DPU2000 and DPU2000R)
61	81R-2 Restore (DPU2000 and DPU2000R)
62	81O-1 Overfrequency (DPU2000 and DPU2000R)
63	81O-2 Overfrequency (DPU2000 and DPU2000R)
70	Blown Fuse Alarm
71	OC Trip Counter
72	Accumulated KSI
73	79 Counter 1 Alarm
74	Phase Demand Alarm
75	Neutral Demand Alarm
76	Low PF Alarm
77	High PF Alarm
78	Trip Coil Failure
79	kVAR Demand Alarm
80	79 Counter 2 Alarm
81	Pos kVAR Alarm
82	Neg. kVAR Alarm
83	Load Alarm
84	Cold Load Alarm
85	Pos Watt Alarm 1
86	Pos Watt Alarm 2
87	32P Trip (DPU2000 and DPU2000R)
88	32N Trip (DPU2000 and DPU2000R)
90	Event Capture #1
91	Event Capture #2
92	Waveform Capture
93	BFT Operation (DPU2000 and DPU2000R)
94	RETRIP Operation (DPU2000 and DPU2000R)
100	ROM Failure
101	RAM Failure
102	Self Test Failed
103	EEPROM Failure
104	BATRAM Failure
105	DSP Failure
106	Control Power Fail
107	Editor Access
128	Springs Charged
129	Springs Discharged
130	79S Input Enabled
131	79S Input Disabled

132	79M Input Enabled
133	79M Input Disabled
134	TCM Input Closed
135	TCM Input Opened
136	ALT 1 Input Enabled
137	ALT 1 Input Disabledabled
138	ALT 2 Input Enabled
139	ALT 2 Input Disabledabled
140	Ext Trip Enabled
141	Ext Trip Disabled
142	Event Cap 1 Init
143	Event Cap 1 Reset
144	Event Cap 2 Init
145	Event Cap 2 Reset
146	Wave Cap Init
147	Wave Cap Reset
148	Ext Close Enabled
149	Ext Close Disabled
150	52a Closed
151	52a Opened
152	52b Closed
153	52b Opened
154	43a Closed
155	43a Opened
156	46 Unit Enabled
157	46 Unit Disabled
158	67P Unit Enabled (DPU2000 and DPU2000R)
159	67P Unit Disabled (DPU2000 and DPU2000R)
160	67N Unit Enabled (DPU2000 and DPU2000R)
161	67N Unit Disabled (DPU2000 and DPU2000R)
162	ULI1 Input Closed (DPU2000 and DPU2000R)
163	ULI1 Input Opened (DPU2000 and DPU2000R)
164	ULI2 Input Closed (DPU2000 and DPU2000R)
165	ULI2 Input Opened (DPU2000 and DPU2000R)
166	ULI3 Input Closed (DPU2000 and DPU2000R)
167	ULI3 Input Opened (DPU2000 and DPU2000R)
168	ULI4 Input Closed (DPU2000 and DPU2000R)
169	ULI4 Input Opened (DPU2000 and DPU2000R)
170	ULI5 Input Closed (DPU2000 and DPU2000R)
171	ULI5 Input Opened (DPU2000 and DPU2000R)
172	ULI6 Input Closed (DPU2000 and DPU2000R)
173	ULI6 Input Opened (DPU2000 and DPU2000R)
174	ULI7 Input Closed (DPU2000 and DPU2000R)
175	ULI7 Input Opened (DPU2000 and DPU2000R)
176	ULI8 Input Closed (DPU2000 and DPU2000R)
177	ULI8 Input Opened (DPU2000 and DPU2000R)
178	ULI9 Input Closed (DPU2000 and DPU2000R)
179	ULI9 Input Opened (DPU2000 and DPU2000R)
180	CRI Input Closed
181	CRI Input Opened
182	ARC Blocked
183	ARC Enabled
184	TARC Opened
185	SEF Enabled (SE Models)
186	SEF Disabled (SE Models)
187	User Display Input On
188	User Display Input Off
189	25 Enabled (DPU2000R)
190	25 Disabled (DPU2000R)

191	Lines Synced
192	Line Sync Loss
193	CB Slow
194	Local Enabled
195	Local Disabled
196	25By Enabled (DPU2000R)
197	25By Disabled (DPU2000R)
198	25 Sync Fail (DPU2000R)
199	Catalog Number Update
200	Reserved
201	Reserved
202	Reserved
203	Reserved
204	Reserved
205	Reserved
206	Reserved
207	Reserved
208	Reserved
209	Reserved
210	Reserved
211	Reserved
212	Reserved
213	Reserved
214	Reserved
215	59G Alarm (DPU2000R)
216	TGT Enabled (DPU2000R)
217	TGT Disabled (DPU2000R)
218	SIA Enabled (DPU2000R)
219	SIA Disabled (DPU2000R)
220	LIS Asserted (DPU2000R)
221	LIR Asserted (DPU2000R)
222	LIS Deasserted (DPU2000R)
223	LIR Deasserted (DPU2000R)
224	LO Asserted (DPU2000R)
225	LO Deasserted (DPU2000R)
226	TR_SET Asserted (DPU2000R)
227	TR_RST Asserted (DPU2000R)
228	TR_SET Deasserted (DPU2000R)
229	TR_RST Deasserted (DPU2000R)
230	TR_ON Asserted (DPU2000R)
231	TR_OFF Asserted (DPU2000R)
232	TR_TAG Asserted (DPU2000R)
233	59-3P Alarm (DPU2000R)
234	47 Alarm (DPU2000R)
235	21P-1 Zone 1 Trip (DPU2000R)
236	21P-2 Zone 2 Trip (DPU2000R)
237	21P-3 Zone 3 Trip (DPU2000R)
238	21P-4 Zone 4 Trip (DPU2000R)

<u>Msg byte</u>	<u>Definition</u>
1/1	Relay Status (see command 3 4 1, msg 1/1)
1/2	Command + Subcommand = 0x5c
1/3	Total Number of Messages = 5
2/1	Year
2/2	Month
2/3	Day
3/1	Hours or Most significant high byte millisec time since midnight
3/2	Minutes or Most significant low byte millisec time since midnight
3/3	Seconds or Least significant high byte millisec time since midnight

4/1	Hundredths of seconds or Least significant low byte millisecond time since midnight, see note in command 3 5 8.
4/2	Message#
4/3	Value (if any) Hi byte
5/1	Value (if any) Lo byte
5/2	Operation Number (high byte)
5/3	Operation Number (low byte)

If the operation entry doesn't exist then send 0's in all the bytes 2/1 through 5/3.

5.5.13 Send Next Operations Record (3 5 13)

Same format as (3 5 12) except Msg 1/2 = 0x5d.

5.5.14 Breaker Status (Including I/O Status) (3 5 14)

Input status bit 0=opened, 1=closed.

Output status bit 0=de-energized, 1=energized.

<u>Msg byte</u>	<u>Definition</u>
1/1	Relay Status (see command 3 4 1, msg 1/1)
1/2	Command + Subcommand = 0x5e
1/3	Total Number of Messages = 3
2/1	Contact Input Status (high byte) Bit 0 - Input 6 (DPU2000 and DPU2000R) Bit 1 - Input 7 (DPU2000 and DPU2000R) Bit 2 - Input 8 (DPU2000 and DPU2000R) or Input 6 (DPU1500R) Bit 3 - Input 9 (DPU2000) Bit 4 - Input 10 (DPU2000) Bit 5 - Input 11 (DPU2000) Bit 6 - Input 12 (DPU2000) Bit 7 - Input 13 (DPU2000)
2/2	Contact Input Status (low byte) Bit 0 - 52a (DPU2000) Bit 1 - 52b (DPU2000) Bit 2 - 43a (DPU2000) Bit 3 - Input 1 Bit 4 - Input 2 Bit 5 - Input 3 Bit 6 - Input 4 Bit 7 - Input 5
2/3	Self Test Status (high byte) Bit 0 - DSP ROM Bit 1 - DSP Internal RAM Bit 2 - DSP External RAM Bit 3 - DSP +/-5V Bit 4 - DSP +/-15V Bit 5 - DSP +5V Bit 6 - DSP Comm. Failure Bit 7 - ADC Failure
3/1	Self Test Status (low byte) Bit 0 - CPU RAM Bit 1 - CPU EPROM Bit 2 - CPU NVRAM Bit 3 - CPU EEPROM Bit 4 - Bit 5 - Bit 6 - Bit 7 -

3/2	Output Contact Status (high byte) Bit 0 - Output 7 (DPU2000) Bit 1 - Output 8 (DPU2000)
3/3	Output Contact Status (low byte) Bit 0 - Trip Bit 1 - Close (DPU2000) Bit 2 - Output 1 Bit 3 - Output 2 Bit 4 - Output 3 Bit 5 - Output 4 Bit 6 - Output 5 Bit 7 - Output 6

5.5.15 Power Fail Data (3 5 15)

<u>Msg byte</u>	<u>Definition</u>
1/1	Relay Status (see command 3 4 1, msg 1/1)
1/2	Command + Subcommand = 0x5f
1/3	Total Number of Messages = 4
2/1	Year
2/2	Month
2/3	Day
3/1	Hour
3/2	Minute
3/3	Second
4/1	Hundredths of second
4/2	Power Fail Type Bit 0: DC Control Bit 1: +5/+15V
4/3	Breaker Status (state)

5.6 Load Profile/Record Commands (3 6 n)

<u>N</u>	<u>Definition</u>
0	Define Load Profile Settings
1	Start Load Profile Data Accumulation
2	Freeze Load Profile Data
3	Report Load Profile Header-All
4	Report Next Load Profile Data Block
5	Retransmit Last Load Profile Data Block
6	Report Load Profile Header-Last
8	Report Oldest Unreported Fault Record
9	Report Oldest Unreported Operations Record

5.6.1 Load Profile Settings (3 6 0)

Reserved for user configuration.

5.6.2 Accumulate Load Profile Data (3 6 1)

Start load profile data collection.

5.6.3 Freeze Load Profile Data (3 6 2)

Stop load profile data collection.

5.6.4 Report Load Profile Data Header (All Data) (3 6 3)

This command is used to initialize the unit to report the entire contents of the accumulated load profile.

<u>Msg byte</u>	<u>Definition</u>
1/1	Relay Status (see command 3 4 1, msg 1/1)

1/2-4/1	Report Column (1-9) Attribute Number
4/2	spare
4/3-9/3	Unit Id Name (16 chars)
10/1-11/2	Time Tag of the first Block reporting (5 bytes :yy,mn,dd,hh,mm in order)
11/3	spare
12/1-12/2	Report Column 1 Attribute Scale(high, low byte)
12/3-17/3	Report Column (2-9) Attribute Scale

<u>Attr#</u>	<u>Description</u>	<u>Dynamic Scale</u>
0	Demand kW-A	122
1	Demand kW-B	122
2	Demand kW-C	122
3	Demand kVar-A	122
4	Demand kVar-B	122
5	Demand kVar-C	122
6	Van	10
7	Vbn	10
8	Vcn	10
9	Demand kW-3P	367
10	Demand kVar-3P	367
11	Demand Ia	1
12	Demand Ib	1
13	Demand Ic	1
14	Vab	10
15	Vbc	10
16	Vca	10

5.6.5 Report Next Load Profile Data Block (3 6 4)

<u>Msg byte</u>	<u>Definition</u>
1/1	Demand Interval (5/15/30/60 Mins)
1/2-1/3	Record # (a number starting from 1 to #of blocks)
2/1	Total Number Data Bytes (1 through 126)
2/2-3/3	Time Tag of the first Block (5 bytes : hh,mm,dd,mn,yy in order) NOTE: Different than command 363 time stamp
4/1-45/3	Data Blocks (up to 126 bytes of data)

Each data block is a two byte word that has the following bit configuration:

bit 0-13:	data values
bit 14:	sign bit (1=multiply bits 0-13 by -1)
bit 15:	scale bit (0=multiply bits 0-13 by 1, 1=multiply bits 0-13 by attribute scale)

Example: Report column 1 is profiling attribute #0 (Demand kW-A) and has a dynamic scale = 122

Data word	Binary pattern	Scale	Reported value
8,000	0001111101000000	1	8,000 kW
24,384	0101111101000000	-1	-8,000 kW
16,776	0100000011000100	122	23,912 kW
49,384	1100000011000100	-122	-23,912 kW

To obtain the reported value column from the data word, a listing for a C routine should look as follows:

```

long int ConvertData( unsigned short ,unsigned short );
long int          report_value;
unsigned short intdata_word;

report_value = ConvertData( data_word ,attribute_scale);
{
    int scale=1;

```

```

if ( data_word & 0x4000 ) /* is sign bit set ? */
{
    scale = -1;
}

if ( data_word & 0x8000 ) /* is scale bit set ? */
{
    scale *= attribute_scale;
}

return( (data_word & 0x3fff) * scale );
}

```

5.6.6 Retransmit the Last Load Profile Data Block (3 6 5)

Same as Report Next Load Profile Data Block except its the previous data sent.

5.6.7 Report Load Profile Data Header(Last Data) (3 6 6)

This command is used to initialize the unit to report the entire contents of the accumulated load profile.

5.6.8 Oldest Unreported Fault Record (3 6 8)

This command will report the oldest unreported fault record. The 3 0 4 command can be issued to determine how many unreported records exist in units queue. The issuance of the 3 6 8 command will decrement the counter by one record.

Unreported Command byte (0=Get Oldest Unreported, 1= Get Last Reported)

<u>Data Byte</u>	<u>Definition</u>
1/1	Unreported Command Byte
1/2	Unreported Command Byte (Duplicate)
1/3	Unreported Command Byte (Triplicate)

Msg Byte Definition
 Same format as (3 5 8) except Msg 1/2 = 0x68.

5.6.9 Oldest Unreported Operations Record (3 6 9)

This command will report the oldest unreported operations record. The 3 0 4 command can be issued to determine how many unreported records exist in units queue. The issuance of the 3 6 9 command will decrement the counter by one record.

Unreported Command byte (0=Get Oldest Unreported, 1= Get Last Reported)

<u>Data Byte</u>	<u>Definition</u>
1/1	Unreported Command Byte
1/2	Unreported Command Byte (Duplicate)
1/3	Unreported Command Byte (Triplicate)

Msg Byte Definition
 Same format as (3 5 12) except Msg 1/2 = 0x69.

5.7 Miscellaneous Commands (3 9 n)

<u>N</u>	<u>Definition</u>
0	Trip Command
1	Close Command
2	Energize Output Contact Command
3	Set/Reset Output Contacts Command
4	Close Command-Independent of 43A
5	Set Forced Physical Inputs Command
6	Receive Forced Logical Inputs Information
7	Set Forced Physical Outputs Command

5.7.1 Trip Command (3 9 0)

The TRIP command will be issued to the DPU. This command has a data message that contains the Password and a command verification code for trip. NOTE: To issue the trip command, the DPU2000 must be in the CLOSED state, 52A closed and 52B opened.

<u>Msg byte</u>	<u>Definition</u>
1/1	Most significant high byte of password
1/2	Most significant low byte of password
1/3	Least significant high byte of password
2/1	Least significant low byte of password
2/2	spare
2/3	Command + Subcommand = 0x90

5.7.2 CLOSE Command (3 9 1)

The CLOSE command will be issued to the DPU. This command has a data message that contains the Password and a command verification code for Close. NOTE: To issue the close command, the DPU2000 must be in the OPEN state and the 43A input must be asserted, 52A opened, 52B closed and 43A closed.

<u>Msg byte</u>	<u>Definition</u>
1/1	Most significant high byte of password
1/2	Most significant low byte of password
1/3	Least significant high byte of password
2/1	Least significant low byte of password
2/2	spare
2/3	Command + Subcommand = 0x91

5.7.3 Energize Output Contact Command (3 9 2)

The test output contact command will be issued to the DPU. This command has a data message that contains the Password and a command verification code and a 16 bit word indicating which contacts should be closed.

The output contact will be a momentary closure for the time period specified in the configuration menu for trip failure time.

<u>Msg byte</u>	<u>Definition</u>
1/1	Most significant high byte of password
1/2	Most significant low byte of password
1/3	Least significant high byte of password
2/1	Least significant low byte of password
2/2	spare
2/3	Command + Subcommand = 0x92
3/1	Output Contact State (high byte) Bit 0 - OUT7 (DPU2000) Bit 1 - OUT8 (DPU2000) Bit 2-7 - Spare
3/2	Output Contact State (low byte) Bit 0 - TRIP Bit 1 - CLOSE (DPU2000) Bit 2 - OUT1 Bit 3 - OUT2 Bit 4 - OUT3 Bit 5 - OUT4 Bit 6 - OUT5 Bit 7 - OUT6
3/3	Output Contact State Confirmation (high byte) Bit 0 - OUT7 (DPU2000) Bit 1 - OUT8 (DPU2000) Bit 2-7 - Spare
4/1	Output Contact State Confirmation (low byte) Bit 0 - TRIP

	Bit 1 - CLOSE (DPU2000)
	Bit 2 - OUT1
	Bit 3 - OUT2
	Bit 4 - OUT3
	Bit 5 - OUT4
	Bit 6 - OUT5
	Bit 7 - OUT6
4/2	Checksum high byte
4/3	Checksum low byte

5.7.4 Set/Reset Output Contacts Command (3 9 3)

This command allows for the assertion/deassertion of the ULO1-9 logical outputs. It also provides the means to reset the sealed in logical output contacts. Outputs denoted with '*' are sealed in and can only be reset.

Bit = 0, Output Not Energized/No Change in Status.

Bit = 1, Output Energized/Change in Status.

<u>Bit</u>	<u>Output Byte1</u>	<u>Output Byte2</u>	<u>Output Byte3</u>
7	27*	51P*	27-3P*
6	46*	51N*	TRIPA*
5	50P-1*	59* (DPU2000/R)	TRIPB*
4	50N-1*	67P* (DPU2000/R)	TRIPC*
3	50P-2*	67N* (DPU2000/R)	ULO1 (DPU2000/R)
2	50N-2*	81S-1* (DPU2000/R)	ULO2 (DPU2000/R)
1	50P-3*	81R-1* (DPU2000/R)	ULO3 (DPU2000/R)
0	50N-3*	81O-1* (DPU2000/R)	ULO4 (DPU2000/R)

<u>Bit</u>	<u>Output Byte4</u>	<u>Output Byte5</u>	<u>Output Byte6</u>
7	ULO5 (DPU2000/R)	79CA1*	25* (DPU2000R w/Synch Check)
6	ULO6 (DPU2000/R)	79CA2*	59G* (DPU2000R)
5	ULO7 (DPU2000/R)	SEF* (SE Models, DPU2000R/1500R)	59-3p* (DPU2000R)
4	ULO8 (DPU2000/R)	BFT* (DPU2000/R)	47* (DPU2000R)
3	ULO9 (DPU2000/R)	RETRIP* (DPU2000/R)	21P-1* (DPU2000R)
2	81O-2* (DPU2000/R)	32P-2* (DPU2000/R)	21P-2* (DPU2000R)
1	81S-2* (DPU2000/R)	32N-2* (DPU2000/R)	21P-3* (DPU2000R)
0	81R-2* (DPU2000/R)	BFA*	21P-4* (DPU2000R)

<u>Bit</u>	<u>Output Byte7</u>	<u>Output Byte8</u>
7		
6		
5		
4		
3		
2		
1		
0		

Example: To Send a command to clear 27-3P* and set ULO4 the following command bytes should be issued:

Set/Reset Output Byte3 = 01 hex

Status Change Output Byte3 = 81 hex

This allows a change to occur for outputs in bit position 7 and 0. Note you can only clear "*" outputs.

<u>Msg byte</u>	<u>Definition</u>
1/1	Most significant high byte of password
1/2	Most significant low byte of password
1/3	Least significant high byte of password

2/1	Least significant low byte of password
2/2	Spare
2/3	Command + Subcommand = 0x93
3/1	Set/Reset Output Byte 1
3/2	Set/Reset Output Byte 2
3/3	Set/Reset Output Byte 3
4/1	Set/Reset Output Byte 4
4/2	Set/Reset Output Byte 5
4/3	Set/Reset Output Byte 6
5/1	Set/Reset Output Byte 7
5/2	Set/Reset Output Byte 8
5/3	Spare
6/1	Spare
6/2	Spare
6/3	Spare
7/1	Status Change Output Byte 1
7/2	Status Change Output Byte 2
7/3	Status Change Output Byte 3
8/1	Status Change Output Byte 4
8/2	Status Change Output Byte 5
8/3	Status Change Output Byte 6
9/1	Status Change Output Byte 7
9/2	Status Change Output Byte 8
9/3	Spare
10/1	Spare
10/2	Spare
10/3	Spare
11/1	Spare
11/2	Checksum high byte
11/3	Checksum low byte

5.7.5 CLOSE Command (3 9 4)

The CLOSE command will be issued to the DPU. This command has a data message that contains the Password and a command verification code for Close. NOTE: To issue the close command, the DPU2000 must be in the OPEN state (independent of 43A input).

<u>Msg byte</u>	<u>Definition</u>
1/1	Most significant high byte of password
1/2	Most significant low byte of password
1/3	Least significant high byte of password
2/1	Least significant low byte of password
2/2	spare
2/3	Command + Subcommand = 0x94

5.7.6 Force Physical Input (3 9 5)

This command is available in DPU2000R and DPU1500R.

This command is issued to the unit and contains a data message that indicates the Password and a command verification code plus two 16 bit words, Normal State mask and Forcing State mask, which indicate which inputs to force and the state to which they are being forced. If the bit specific to an input is reset in the Normal State mask then all input operations for that input will proceed according to normal logical conditions. If the Normal State mask bit specific to an input is set then all input operations for that input will be ignored and the Forcing State mask will be utilized to force the input condition indicated by the Forcing State mask.

<u>Msg byte</u>	<u>Definition</u>
1/1	Most significant high byte of password
1/2	Most significant low byte of password
1/3	Least significant high byte of password
2/1	Least significant low byte of password
2/2	Spare

2/3	Command + Subcommand = 0x95
3/1	high byte of Change state mask
3/2	low byte of Change state mask
3/3	high byte of Normal state mask
4/1	low byte of Normal state mask
4/2	high byte of Forcing state mask
4/3	low byte of Forcing state mask
5/1	Spare
5/2	Spare
5/3	Spare
6/1	Spare
6/2	Checksum high byte
6/3	Checksum low byte

Change State mask (Bit definition):

0 = No change , 1 = Associated input is defined by the states in the Normal and Forcing masks.

Normal State mask (Bit definition):

0 = Normal State, 1 = Normal State over ride.

Forcing State mask (Bit definition):

0 = Forcing Reset state, 1 = Forcing Set State.

Bit Position:	0	1	2	3	4	5	6	7	8	9	10	11	12	13	14	15
DPU2000R:	IN3	IN4	FB1	IN2	FB2	FB3	FB4	FB5	IN1	FB6	IN8	IN7	IN6	IN5	FB7	FB8
DPU1500R:	IN3	IN4	N/A	IN2	N/A	N/A	N/A	N/A	IN1	N/A	IN6	N/A	N/A	IN5	N/A	N/A

5.7.7 Force Logical Input (3 9 6)

This command is available in DPU2000R and DPU1500R.

This command is issued to the unit and contains a data message that indicates the Password and a command verification code plus four 32 bit words, the Normal State masks and Forcing State masks, which indicate which inputs to force and the state to which they are being forced. If the bit specific to an input is reset in the Normal State masks then all input operations for that input will proceed according to normal logical conditions. If the Normal State mask bit specific to an input is set in the Normal State masks then all input operations for that input will be ignored and the Forcing State mask will be utilized to force the input condition indicated by the Forcing State mask.

<u>Msg byte</u>	<u>Definition</u>
1/1	Most significant high byte of password
1/2	Most significant low byte of password
1/3	Least significant high byte of password
2/1	Least significant low byte of password
2/2	Spare
2/3	Command + Subcommand = 0x96
3/1	Most significant high byte of 1st unsigned long word Change state mask
3/2	Most significant low byte of 1st unsigned long word for Change state mask
3/3	Least significant high byte of 1st unsigned long word Change state mask
4/1	Least significant low byte of 1st unsigned long word for Change state mask
4/2	Most significant high byte of 1st unsigned long word for Normal State mask
4/3	Most significant low byte of 1st unsigned long word for Normal State mask
5/1	Least significant high byte of 1st unsigned long word for Normal State mask
5/2	Least significant low byte of 1st unsigned long word for Normal State mask
5/3	Most significant high byte of 1st unsigned long word for Forcing State mask
6/1	Most significant low byte of 1st unsigned long word for Forcing State mask
6/2	Least significant high byte of 1st unsigned long word for Forcing State mask
6/3	Least significant low byte of 1st unsigned long word for Forcing State mask
7/1	Spare
7/2	Spare
7/3	Spare

8/1	Spare
8/2	Checksum high byte
8/3	Checksum low byte

Both unsigned long words for the Change State mask, the Normal State mask and the Forcing State mask, break down as follows for the DPU2000R and DPU1500R:

Bits 31:FLI31	Bits 23:FLI23	Bits 15: FLI15	Bits 07: FLI07
Bits 30:FLI30	Bits 22:FLI22	Bits 14: FLI14	Bits 06: FLI06
Bits 29:FLI29	Bits 21:FLI21	Bits 13: FLI13	Bits 05: FLI05
Bits 28:FLI28	Bits 20:FLI20	Bits 12: FLI12	Bits 04: FLI04
Bits 27:FLI27	Bits 19:FLI19	Bits 11: FLI11	Bits 03: FLI03
Bits 26:FLI26	Bits 18:FLI18	Bits 10: FLI10	Bits 02: FLI02
Bits 25:FLI25	Bits 17:FLI17	Bits 09: FLI09	Bits 01: FLI01
Bits 24:FLI24	Bits 16:FLI16	Bits 08: FLI08	Bits 00: FLI00

5.7.8 Force Physical Output Contact Command (3 9 7)

This command is available in DPU2000R and DPU1500R.

This command is issued to the unit and contains a data message that indicates the Password and a command verification code plus two 16 bit words, Normal State mask and Forcing State mask, which indicate which outputs to force and the state to which they are being forced. If the bit specific to an output is reset in the Normal State mask then all output operations for that output will proceed according to normal logical conditions. If the Normal State mask bit specific to an output is set then all output operations for that output will be ignored and the Forcing State mask will be utilized to force the output condition indicated by the Forcing State mask.

<u>Msg byte</u>	<u>Definition</u>
1/1	Most significant high byte of password
1/2	Most significant low byte of password
1/3	Least significant high byte of password
2/1	Least significant low byte of password
2/2	Spare
2/3	Command + Subcommand = 0x97
3/1	high byte of Change state mask
3/2	low byte of Change state mask
3/3	high byte of Normal state mask
4/1	low byte of Normal state mask
4/2	high byte of Forcing state mask
4/3	low byte of Forcing state mask
5/1	Spare
5/2	Spare
5/3	Spare
6/1	Spare
6/2	Checksum high byte
6/3	Checksum low byte

Change State mask (Bit definition):

0 = No change , 1 = Associated input is defined by the states in the Normal and Forcing masks.

Normal State mask (Bit definition):

0 = Normal State, 1 = Normal State over ride.

Forcing State mask (Bit definition):

0 = Forcing Reset state, 1 = Forcing Set State.

Bit Position:	0	1	2	3	4	5	6	7	8	9	10	11	12	13	14	15
DPU2000R:	Trip	N/A	Out6	Out4	Out5	Out3	Out2	Out1	N/A	N/A	N/A	N/A	N/A	N/A	N/A	N/A
DPU1500R:	Trip	N/A	Out6	Out4	Out5	Out3	Out2	Out1	N/A	N/A	N/A	N/A	N/A	N/A	N/A	N/A

5.8 Receive Buffer "N" Commands (3 10 n)

<u>N</u>	<u>Definition</u>
0	Reserved for repeat 3 10 n
1	Communications Settings
2	Counter Settings
3	Master Trip Output Assignment
4	Breaker Failure Settings

5.8.1 Receive Communications Settings (3 10 1)

Low byte consists of bits 0 through 7.

High byte consists of bits 8 through 15.

Port configuration byte

bit 0-3 = port baud rate (0=300,1=1200,2=2400,3=4800, 4=9600,5=19200,6=38400)

bit 4-5 = parity (0=None,1=Odd,2=Even)

bit 6 = number of data bits (0=seven,1=eight)

bit 7 = number of stop bits (0=one,1=two)

Msg byte

Definition

1/1	Most significant high byte of password
1/2	Most significant low byte of password
1/3	Least significant high byte of password
2/1	Least significant low byte of password
2/2	Spare
2/3	Command + Subcommand = 0xa1
3/1	Unit Address high byte
3/2	Unit Address low byte
3/3	Front Panel RS 232 configuration byte
4/1	Rear Panel RS 232 or INCOM configuration byte
4/2	Rear Panel RS 485 configuration byte
4/3	Rear Panel IRIG byte (0=Disable; 1=Enable-cc, time stamp reporting will be HH:MM:SS.cc; 2=Enable-mmm, time stamp reporting will be HH:MM:SS.mmm)
5/1	Spare
5/2	Spare
5/3	Aux Port Parameter 1 byte (0-255)
6/1	Aux Port Parameter 2 byte (0-255)
6/2	Aux Port Parameter 3 byte (0-255)
6/3	Aux Port Parameter 4 byte (0-255)
7/1	Aux Port Parameter 5 byte (0-255)
7/2	Aux Port Parameter 6 byte (0-255)
7/3	Aux Port Parameter 7 byte (0-255)
8/1	Aux Port Parameter 8 byte (0-255)
8/2	Aux Port Parameter 9 byte (0-255)
8/3	Aux Port Parameter 10 byte (0-255)
9/1	Aux Port Parameter Mode byte (0-255) Bit 0: Par Mode 1 (0=Disable, 1=Enable) Bit 1: Par Mode 2 (0=Disable, 1=Enable) Bit 2: Par Mode 3 (0=Disable, 1=Enable) Bit 3: Par Mode 4 (0=Disable, 1=Enable) Bit 4: Par Mode 5 (0=Disable, 1=Enable) Bit 5: Par Mode 6 (0=Disable, 1=Enable) Bit 6: Par Mode 7 (0=Disable, 1=Enable) Bit 7: Par Mode 8 (0=Disable, 1=Enable)
9/2	Spare
9/3	Spare

10/1	Spare
10/2	Checksum high byte
10/3	Checksum low byte

5.8.2 Receive Counter Settings (3 10 2)

NOTE: Overcurrent Trip Counters A, B, C, and N are available with Recloser Curve Software option, catalog numbers XXXXXXXX-XXX2X or XXXXXXXX-XXX3X. In DPU2000 series, CPU V1.41 or higher is required for the Recloser Curve Software option.

<u>Msg byte</u>	<u>Definition</u>
1/1	Most significant high byte of password
1/2	Most significant low byte of password
1/3	Least significant high byte of password
2/1	Least significant low byte of password
2/2	Spare
2/3	Command + Subcommand = 0xa2
3/1	KSI Sum A Counter high byte(0-9999)
3/2	KSI Sum A Counter low byte
3/3	KSI Sum B Counter high byte(0-9999)
4/1	KSI Sum B Counter low byte
4/2	KSI Sum C Counter high byte(0-9999)
4/3	KSI Sum C Counter low byte
5/1	Over Current Trip Counter high byte(0-9999)
5/2	Over Current Trip Counter low byte
5/3	Breaker Operations Counter high byte(0-9999)
6/1	Breaker Operations Counter low byte
6/2	Reclose Counter 1 high byte(0-9999)
6/3	Reclose Counter 1 low byte
7/1	1st Reclose Counter high byte(0-9999)
7/2	1st Reclose Counter low byte
7/3	2nd Reclose Counter high byte(0-9999)
8/1	2nd Reclose Counter low byte
8/2	3rd Reclose Counter high byte(0-9999)
8/3	3rd Reclose Counter low byte
9/1	4th Reclose Counter high byte(0-9999)
9/2	4th Reclose Counter low byte
9/3	Reclose Counter 2 high byte(0-9999)
10/1	Reclose Counter 2 low byte
10/2	Overcurrent Trip A Counter high byte(0-9999), (DPU2000/R)
10/3	Overcurrent Trip A Counter low byte
11/1	Overcurrent Trip B Counter high byte(0-9999) , (DPU2000/R)
11/2	Overcurrent Trip B Counter low byte
11/3	Overcurrent Trip C Counter high byte(0-9999) , (DPU2000/R)
12/1	Overcurrent Trip C Counter low byte
12/2	Overcurrent Trip N Counter high byte(0-9999) , (DPU2000/R)
12/3	Overcurrent Trip N Counter low byte
13/1	SPARE
13/2	SPARE
13/3	SPARE
14/1	SPARE
14/2	SPARE
14/3	SPARE
15/1	SPARE
15/2	SPARE
15/3	SPARE
16/1	SPARE
16/2	Checksum high byte
16/3	Checksum low byte

5.8.3 Receive Master Trip Output Assignment (3 10 3)

NOTE: DPU2000 series requires CPU version 1.70 and above.

<u>Msg/Byte</u>	<u>Definition</u>
1/1	Most significant high byte of password
1/2	Most significant low byte of password
1/3	Least significant high byte of password
2/1	Least significant low byte of password
2/2	Spare
2/3	Command + Subcommand = 0xa3
3/1	Master Trip Assignment, Byte 1 Bit 0: SPARE Bit 1: SPARE Bit 2: SPARE Bit 3: SPARE Bit 4: SPARE Bit 5: SPARE Bit 6: SPARE Bit 7: SPARE
3/2	Master Trip Assignment, Byte 2 Bit 0: SPARE Bit 1: SPARE Bit 2: SPARE Bit 3: SPARE Bit 4: SPARE Bit 5: SPARE Bit 6: SPARE Bit 7: SPARE
3/3	Master Trip Assignment, Byte 3 Bit 0: 67P (DPU2000 and DPU2000R) Bit 1: 67N (DPU2000 and DPU2000R) Bit 2: 46 Bit 3: SPARE Bit 4: SPARE Bit 5: SPARE Bit 6: SPARE Bit 7: SPARE
4/1	Master Trip Assignment, Byte 4 Bit 0: 50N-1 Bit 1: 50N-2 Bit 2: 50N-3 Bit 3: 51N Bit 4: 50P-1 Bit 5: 50P-2 Bit 6: 50P-3 Bit 7: 51P
4/2	Spare
4/3	Spare
5/1	Spare
5/2	Spare
5/3	Spare
6/1	Spare
6/2	Checksum, high byte
6/3	Checksum, low byte

5.8.4 Breaker Failure Settings (3 10 4)

NOTE: This command is NOT available in DPU1500R. DPU2000 series requires CPU version 1.70 and above.

<u>Msg/Byte</u>	<u>Definition</u>
1/1	Most significant high byte of password
1/2	Most significant low byte of password
1/3	Least significant high byte of password
2/1	Least significant low byte of password
2/2	Spare
2/3	Command + Subcommand = 0xa4
3/1	Enable (1=ON, 0=OFF)
3/2	BFT Pickup Time Delay (high byte)
3/3	BFT Pickup Time Delay (low byte)
4/1	BFT Drop Time Delay
4/2	BFT Starters
	Bit 0: External input
	Bit 1: Phase Level Detector
	Bit 2: Neutral Level Detector
4/3	ReTrip Pickup Time Delay (high byte)
5/1	ReTrip Pickup Time Delay (low byte)
5/2	ReTrip Drop Time Delay
5/3	ReTrip Starters
	Bit 0: External input
	Bit 1: Phase Level Detector
	Bit 2: Neutral Level Detector
6/1	Phase Level Detector Pickup (5 to 100% of 51P)
6/2	Neutral Level Detector Pickup (5 to 100% of 51N)
6/3	Spare
7/1	Spare
7/2	Spare
7/3	Spare
8/1	Spare
8/2	Checksum, high byte
8/3	Checksum, low byte

5.9 Receive Edit Buffer "N" Commands (3 11 n)

<u>N</u>	<u>Definition</u>
0	Reserved for Repeat
1	Programmable Input Select and Index Tables
2	Programmable Input Negated AND Table
3	Programmable Input AND/OR Table
4	Programmable Input User Defined Input Names
5	Programmable Output Select Table
6	Programmable Output AND/OR Table
7	Programmable Output User Defined Output Names
8	Primary Relay Settings
9	Alternate 1 Relay Settings
10	Alternate 2 Relay Settings
11	Configuration Settings
12	Counter Settings
13	Alarm Settings
14	Real Time Clock
15	Programmable Output Delays

5.9.1 Receive Programmable Input Select and Index (3 11 1)

Bit Position:	0	1	2	3	4	5	6	7	8	9	10	11	12	13	14	15
DPU2000:	IN3	IN4	IN9	IN2	IN10	43A	52B	52A	IN1	IN11	IN8	IN7	IN6	IN5	IN13	IN12
DPU2000R:	IN3	IN4	FB1	IN2	FB2	FB3	FB4	FB5	IN1	FB6	IN8	IN7	IN6	IN5	FB7	FB8
DPU1500R:	IN3	IN4	N/A	IN2	N/A	N/A	N/A	N/A	IN1	N/A	IN6	N/A	N/A	IN5	N/A	N/A

Figure 11 - Physical Input Mapping

- Bit = 0, Physical Input is selected.
- Bit = 1, Physical Input is not selected.
- Low byte consists of bits 0 through 7.
- High byte consists of bits 8 through 15.
- Index byte is the offset into the DPU's logical input structure.

Logical Input List for DPU2000 - Requires matrix (29 x 16) to allow user to map 29 Logical Inputs to 13 Physical Inputs plus "43A", "52A", and "52B". Logical Inputs include: "TCM", "GRD", "PH3", "50-1", "50-2", "50-3", "ALT1", "ALT2", "ZSC", "SCC", "79S", "79M", "OPEN", "CLOSE", "ECI1", "ECI2", "WCI", "46", "67P", "67N", "ULI1", "ULI2", "ULI3", "ULI4", "ULI5", "ULI6", "ULI7", "ULI8", "ULI9", "CRI", "UDI".

Logical Input List for DPU2000R - Requires matrix (29 x 16) to allow user to map 29 Logical Inputs to 8 Physical Inputs plus 8 Feedback Inputs. Logical Inputs include: "52A", "52B", "43A", "TCM", "GRD", "PH3", "50-1", "50-2", "50-3", "ALT1", "ALT2", "ZSC", "SCC", "79S", "79M", "OPEN", "CLOSE", "ECI1", "ECI2", "WCI", "46", "67P", "67N", "ULI1", "ULI2", "ULI3", "ULI4", "ULI5", "ULI6", "ULI7", "ULI8", "ULI9", "CRI", "ARCI", "TARC", "SEF" (*Sensitive Earth Model*), "EXTBF", "BFI", "UDI", "25"(*Synch Check Model*), "25By"(*Synch Check Model*). The following logical inputs are available in CPU versions greater than 1.92: "LOCAL", "TGT", "SIA", The following logical inputs are available in CPU version greater than 4.02 (2.01 for PTH): LIS1, LIS2, LIS3, LIS4, LIS5, LIS6, LIS7, LIS8, LIR1, LIR2, LIR3, LIR4, LIR5, LIR6, LIR7, LIR8, TR_SET, TR_RST.

Logical Input List for DPU1500R - Requires matrix (29 x 6) to allow user to map 29 Logical Inputs to 6 Physical Inputs. Logical Inputs include: "52A", "52B", "43A", "TCM", "GRD", "PH3", "50-1", "50-2", "50-3", "ALT1", "ALT2", "ZSC", "SCC", "79S", "79M", "OPEN", "CLOSE", "ECI1", "ECI2", "WCI", "46", "CRI", "ARCI", "TARC", "SEF" (*Sensitive Earth Model*), "UDI", "LOCAL", "TGT", "SIA".

Below is the complete listing of Logical Input Offsets and their respective definitions.

<u>Offset</u>	<u>Definitions</u>
00	52A Breaker Position - Closed/Opened
01	52B Breaker Position - Opened/Closed
02	43A Reclose Function - Enabled/Disabled
03	PH3 Phase Torque Control
04	GRD Ground Torque Control
05	SCC Spring Charging Contact
06	79S Single Shot Reclosing
07	79M Multi Shot Reclosing
08	TCM Trip Coil Monitoring
09	50-1 Instantaneous 50P-1 50N-1
10	50-2 Instantaneous 50P-2 50N-2
11	50-3 Instantaneous 50P-3 50N-3
12	ALT1 Enables ALT1 settings table
13	ALT2 Enables AIT2 settings table
14	ECI1 Event Capture Initiated data in fault record
15	ECI2 Event Capture Initiated data in fault record
16	WCI Waveform Capture Initiated
17	Zone Sequence Coordination
18	Open Trip initiated
19	Close Initiated
20	46 Enables 46 Function
21	67P Enables 67P Function
22	67N Enables 67N Function
23	ULI1 User Logical Input Asserts ULO1
24	ULI2 User Logical Input Asserts ULO2
25	ULI3 User Logical Input Asserts ULO3
26	ULI4 User Logical Input Asserts ULO4
27	ULI5 User Logical Input Asserts ULO5
28	ULI6 User Logical Input Asserts ULO6
29	ULI7 User Logical Input Asserts ULO7
30	ULI8 User Logical Input Asserts ULO8
31	ULI9 User Logical Input Asserts ULO9

32	CRI	Resets Overcurrent Trip And all Recloser Counters
33	ARCI	Timed Reclose Block
34	TARC	Initiate Trip and Automatic Reclose
35	SEF	Sensitive Earth Fault Enable
36	EXTBFI	External Starter Input
37	BFI	Breaker Fail Initiate
38	UDI	User-defined Display Input
39	25	
40	25By	
41	LOCAL	Local Enable
42	TGT	
43	SIA	
44	LIS1	Latching logical input 1 set
45	LIS2	Latching logical input 2 set
46	LIS3	Latching logical input 3 set
47	LIS4	Latching logical input 4 set
48	LIS5	Latching logical input 5 set
49	LIS6	Latching logical input 6 set
50	LIS7	Latching logical input 7 set
51	LIS8	Latching logical input 8 set
52	LIR1	Latching logical input 1 reset
53	LIR2	Latching logical input 2 reset
54	LIR3	Latching logical input 3 reset
55	LIR4	Latching logical input 4 reset
56	LIR5	Latching logical input 5 reset
57	LIR6	Latching logical input 6 reset
58	LIR7	Latching logical input 7 reset
59	LIR8	Latching logical input 8 reset
60	TR_SET	Hot hold tagging logical input set
61	TR_RST	Hot hold tagging logical input reset

Msg byte

Definition

1/1	Most significant high byte of password
1/2	Most significant low byte of password
1/3	Least significant high byte of password
2/1	Least significant low byte of password
2/2	Spare
2/3	Command + Subcommand = 0xb1
3/1	INPUT1 high byte
3/2	INPUT1 low byte
3/3	INPUT1 index byte
4/1	INPUT2 high byte
4/2	INPUT2 low byte
4/3	INPUT2 index byte
5/1	INPUT3 high byte
5/2	INPUT3 low byte
5/3	INPUT3 index byte
6/1	INPUT4 high byte
6/2	INPUT4 low byte
6/3	INPUT4 index byte
7/1	INPUT5 high byte
7/2	INPUT5 low byte
7/3	INPUT5 index byte
8/1	INPUT6 high byte
8/2	INPUT6 low byte
8/3	INPUT6 index byte
9/1	INPUT7 high byte
9/2	INPUT7 low byte
9/3	INPUT7 index byte

10/1	INPUT8 high byte
10/2	INPUT8 low byte
10/3	INPUT8 index byte
11/1	INPUT9 high byte
11/2	INPUT9 low byte
11/3	INPUT9 index byte
12/1	INPUT10 high byte
12/2	INPUT10 low byte
12/3	INPUT10 index byte
13/1	INPUT11 high byte
13/2	INPUT11 low byte
13/3	INPUT11 index byte
14/1	INPUT12 high byte
14/2	INPUT12 low byte
14/3	INPUT12 index byte
15/1	INPUT13 high byte
15/2	INPUT13 low byte
15/3	INPUT13 index byte
16/1	INPUT14 high byte
16/2	INPUT14 low byte
16/3	INPUT14 index byte
17/1	INPUT15 high byte
17/2	INPUT15 low byte
17/3	INPUT15 index byte
18/1	INPUT16 high byte
18/2	INPUT16 low byte
18/3	INPUT16 index byte
19/1	INPUT17 high byte
19/2	INPUT17 low byte
19/3	INPUT17 index byte
20/1	INPUT18 high byte
20/2	INPUT18 low byte
20/3	INPUT18 index byte
21/1	INPUT19 high byte
21/2	INPUT19 low byte
21/3	INPUT19 index byte
22/1	INPUT20 high byte
22/2	INPUT20 low byte
22/3	INPUT20 index byte
23/1	INPUT21 high byte
23/2	INPUT21 low byte
23/3	INPUT21 index byte
24/1	INPUT22 high byte
24/2	INPUT22 low byte
24/3	INPUT22 index byte
25/1	INPUT23 high byte
25/2	INPUT23 low byte
25/3	INPUT23 index byte
26/1	INPUT24 high byte
26/2	INPUT24 low byte
26/3	INPUT24 index byte
27/1	INPUT25 high byte
27/2	INPUT25 low byte
27/3	INPUT25 index byte
28/1	INPUT26 high byte
28/2	INPUT26 low byte
28/3	INPUT26 index byte
29/1	INPUT27 high byte
29/2	INPUT27 low byte

29/3	INPUT27 index byte
30/1	INPUT28 high byte
30/2	INPUT28 low byte
30/3	INPUT28 index byte
31/1	INPUT29 high byte
31/2	INPUT29 low byte
31/3	INPUT29 index byte
32/1	Spare
32/2	Checksum high byte
32/3	Checksum low byte

5.9.2 Receive Programmable Input Negated AND (3 11 2)

Bit = 0, Enabled when input is opened.

Bit = 1, Enabled when input is closed.

Low byte consists of bits 0 through 7.

High byte consists of bits 8 through 15.

<u>Msg byte</u>	<u>Definition</u>
1/1	Most significant high byte of password
1/2	Most significant low byte of password
1/3	Least significant high byte of password
2/1	Least significant low byte of password
2/2	spare
2/3	Command + Subcommand = 0xb2
3/1	INPUT1 high byte
3/2	INPUT1 low byte
3/3	INPUT2 high byte
4/1	INPUT2 low byte
4/2	INPUT3 high byte
4/3	INPUT3 low byte
5/1	INPUT4 high byte
5/2	INPUT4 low byte
5/3	INPUT5 high byte
6/1	INPUT5 low byte
6/2	INPUT6 high byte
6/3	INPUT6 low byte
7/1	INPUT7 high byte
7/2	INPUT7 low byte
7/3	INPUT8 high byte
8/1	INPUT8 low byte
8/2	INPUT9 high byte
8/3	INPUT9 low byte
9/1	INPUT10 high byte
9/2	INPUT10 low byte
9/3	INPUT11 high byte
10/1	INPUT11 low byte
10/2	INPUT12 high byte
10/3	INPUT12 low byte
11/1	INPUT13 high byte
11/2	INPUT13 low byte
11/3	INPUT14 high byte
12/1	INPUT14 low byte
12/2	INPUT15 high byte
12/3	INPUT15 low byte
13/1	INPUT16 high byte
13/2	INPUT16 low byte
13/3	INPUT17 high byte
14/1	INPUT17 low byte
14/2	INPUT18 high byte

14/3	INPUT18 low byte
15/1	INPUT19 high byte
15/2	INPUT19 low byte
15/3	INPUT20 high byte
16/1	INPUT20 low byte
16/2	INPUT21 high byte
16/3	INPUT21 low byte
17/1	INPUT22 high byte
17/2	INPUT22 low byte
17/3	INPUT23 high byte
18/1	INPUT23 low byte
18/2	INPUT24 high byte
18/3	INPUT24 low byte
19/1	INPUT25 high byte
19/2	INPUT25 low byte
19/3	INPUT26 high byte
20/1	INPUT26 low byte
20/2	INPUT27 high byte
20/3	INPUT27 low byte
21/1	INPUT28 high byte
21/2	INPUT28 low byte
21/3	INPUT29 high byte
22/1	INPUT29 low byte
22/2	Checksum high byte
22/3	Checksum low byte

5.9.3 Receive Programmable Input AND/OR Select (3 11 3)

Bit = 0, Selected inputs are ORed together.
 Bit = 1, Selected inputs are ANDed together.

<u>Msg byte</u>	<u>Definition</u>
1/1	Most significant high byte of password
1/2	Most significant low byte of password
1/3	Least significant high byte of password
2/1	Least significant low byte of password
2/2	spare
2/3	Command + Subcommand = 0xb3
3/1	Programmable input AND/OR selection bits 24-31
3/2	Programmable input AND/OR selection bits 16-23
3/3	Programmable input AND/OR selection bits 8-15
4/1	Programmable input AND/OR selection bits 0-7
4/2	Checksum high byte
4/3	Checksum low byte

<u>Bit</u>	<u>Logical Input</u>
0	INPUT1
1	INPUT2
.	.
.	.
.	.
27	INPUT28
28	INPUT29
29	not used reserved for 52A
30	not used reserved for 52B
31	not used reserved for 43A

5.9.4 Receive Programmable Input User Defined Strings (3 11 4)

User definable 8 char input strings. Byte 9 is an implied NULL

<u>Msg byte</u>	<u>Definition</u>
1/1	Most significant high byte of password
1/2	Most significant low byte of password
1/3	Least significant high byte of password
2/1	Least significant low byte of password
2/2	spare
2/3	Command + Subcommand = 0xb4
3/1-5/2	IN1 Character String 8 bytes
5/3-8/1	IN2 Character String 8 bytes
8/2-10/3	IN3 Character String 8 bytes
11/1-13/2	IN4 Character String 8 bytes
13/3-16/1	IN5 Character String 8 bytes
16/2-18/3	IN6 Character String 8 bytes
19/1-21/2	IN7 Character String 8 bytes (DPU2000/2000R)
21/3-24/1	IN8 Character String 8 bytes (DPU2000/2000R)
24/2-26/3	IN9 Character String 8 bytes (DPU2000)
27/1-29/2	IN10 Character String 8 bytes (DPU2000)
29/3-32/1	IN11 Character String 8 bytes (DPU2000)
32/2-34/3	IN12 Character String 8 bytes (DPU2000)
35/1-37/2	IN13 Character String 8 bytes (DPU2000)
37/3-38/1	spares
38/2	Checksum high byte
38/3	Checksum low byte

5.9.5 Receive Programmable Output Select (3 11 5)

NOTE: Feedback terms are available in DPU2000R, CPU version 1.60 and above.

Bit Position:	0	1	2	3	4	5	6	7	8	9	10	11	12	13	14	15
DPU2000:	Trip	Close	Out6	Out4	Out5	Out3	Out2	Out1	Out7	Out8	N/A	N/A	N/A	N/A	N/A	N/A
DPU2000R:	Trip	N/A	Out6	Out4	Out5	Out3	Out2	Out1	FB1	FB2	FB3	FB4	FB5	FB6	FB7	FB8
DPU1500R:	Trip	N/A	Out6	Out4	Out5	Out3	Out2	Out1	N/A	N/A	N/A	N/A	N/A	N/A	N/A	N/A

Figure 12 - Physical Output Mapping

Programmable Output data transferred from PC to relay.

- Bit = 0, Physical Output is selected.
- Bit = 1, Physical Output is not selected.
- Least significant low byte consists of bits 0 through 7.
- Least significant high byte consists of bits 8 through 15.
- Most significant low byte consists of bits 16 through 23.
- Most significant high byte consists of bits 24 through 31.

<u>Msg byte</u>	<u>Definition</u>
1/1	Most significant high byte of password
1/2	Most significant low byte of password
1/3	Least significant high byte of password
2/1	Least significant low byte of password
2/2	spare
2/3	Command + Subcommand = 0xb5
3/1	Contact OUT6 most significant high byte
3/2	Contact OUT6 most significant low byte
3/3	Contact OUT6 least significant high byte
4/1	Contact OUT6 least significant low byte
4/2	Contact OUT4 most significant high byte
4/3	Contact OUT4 most significant low byte
5/1	Contact OUT4 least significant high byte
5/2	Contact OUT4 least significant low byte
5/3	Contact OUT5 most significant high byte

6/1	Contact OUT5 most significant low byte
6/2	Contact OUT5 least significant high byte
6/3	Contact OUT5 least significant low byte
7/1	Contact OUT3 most significant high byte
7/2	Contact OUT3 most significant low byte
7/3	Contact OUT3 least significant high byte
8/1	Contact OUT3 least significant low byte
8/2	Contact OUT2 most significant high byte
8/3	Contact OUT2 most significant low byte
9/1	Contact OUT2 least significant high byte
9/2	Contact OUT2 least significant low byte
9/3	Contact OUT1 most significant high byte
10/1	Contact OUT1 most significant low byte
10/2	Contact OUT1 least significant high byte
10/3	Contact OUT1 least significant low byte
11/1	Contact OUT7 most significant high byte (DPU2000) DPU2000R FB1 most significant high byte
11/2	Contact OUT7 most significant low byte (DPU2000) DPU2000R FB1 most significant low byte
11/3	Contact OUT7 least significant high byte (DPU2000) DPU2000R FB1 least significant high byte
12/1	Contact OUT7 least significant low byte (DPU2000) DPU2000R FB1 least significant low byte
12/2	Contact OUT8 most significant high byte (DPU2000) DPU2000R FB2 most significant high byte
12/3	Contact OUT8 most significant low byte (DPU2000) DPU2000R FB2 most significant low byte
13/1	Contact OUT8 least significant high byte (DPU2000) DPU2000R FB2 least significant high byte
13/2	Contact OUT8 least significant low byte (DPU2000) DPU2000R FB2 least significant low byte
13/3	DPU2000R FB3 most significant high byte
14/1	DPU2000R FB3 most significant low byte
14/2	DPU2000R FB3 least significant high byte
14/3	DPU2000R FB3 least significant low byte
15/1	DPU2000R FB4 most significant high byte
15/2	DPU2000R FB4 most significant low byte
15/3	DPU2000R FB4 least significant high byte
16/1	DPU2000R FB4 least significant low byte
16/2	DPU2000R FB5 most significant high byte
16/3	DPU2000R FB5 most significant low byte
17/1	DPU2000R FB5 least significant high byte
17/2	DPU2000R FB5 least significant low byte
17/3	DPU2000R FB6 most significant high byte
18/1	DPU2000R FB6 most significant low byte
18/2	DPU2000R FB6 least significant high byte
18/3	DPU2000R FB6 least significant low byte
19/1	DPU2000R FB7 most significant high byte
19/2	DPU2000R FB7 most significant low byte
19/3	DPU2000R FB7 least significant high byte
20/1	DPU2000R FB7 least significant low byte
20/2	DPU2000R FB8 most significant high byte
20/3	DPU2000R FB8 most significant low byte
21/1	DPU2000R FB8 least significant high byte
21/2	DPU2000R FB8 least significant low byte
21/3	Spare
22/1	Spare
22/2	Checksum high byte
22/3	Checksum low byte

5.9.6 Receive Programmable Output AND/OR/Index (3 11 6)

Bit = 0, Selected outputs are ORed together.

Bit = 1, Selected outputs are ANDed together.

Index byte is the offset into the DPU's logical output structure.

Logical Output List for DPU2000 - Requires matrix (32 x 8) to allow user to map 32 Logical Outputs to 8 Physical Outputs.

NOTE: first two logicals, **TRIP** and **CLOSE** are fixed (bits 0 and 1), user is not permitted to remove these from the list. Logical Outputs include: "TRIP", "CLOSE", "ALARM", "BFA", "TCFA", "79LOA", "TCC", "PUA", "51P", "51N", "46", "50P-1", "50N-1", "50P-2", "50N-2", "50P-3", "50N-3", "PATA", "PBTA", "PCTA", "67P", "67N", "81S-1", "81R-1", "81O-1", "27-1P", "59", "79DA", "79CA1", "OCTC", "KSI", "PDA", "NDA", "PVArA", "NVArA", "LOADA", "50-1D", "LPFA", "HPFA", "ZSC", "50-2D", "BFUA", "STCA", "PH3-D", "GRD-D", "32PA", "32NA", "27-3P", "VarDA", "79CA2", "TRIPA", "TRIPB", "TRIPC", "27-1P*", "46*", "50P-1*", "50N-1*", "50P-2*", "50N-2*", "50P-3*", "50N-3*", "51P*", "51N*", "59*", "67P*", "67N*", "81S-1*", "81R-1*", "81O-1*", "27-3P*", "TRIPA*", "TRIPB*", "TRIPC*", "ULO1", "ULO2", "ULO3", "ULO4", "ULO5", "ULO6", "ULO7", "ULO8", "ULO9", "81O-2", "81S-2", "81R-2", "81O-2*", "81S-2*", "81R-2*", "CLTA", "PWatt1", "PWatt2", "79CA1*", "79CA2*", "BFA*".

Logical Output List for DPU2000R - Requires matrix (31 x 14) to allow user to map 31 Logical Outputs to 6 Physical Outputs plus 8 Feedback Outputs. NOTE: first logical, **TRIP** is fixed, user is not permitted to remove Trip logical from the list. Also note, since the **CLOSE** logical is specific to DPU2000, mapping of this logical (located at bit 1) is NOT permissible. Logical Outputs include: "TRIP", "CLOSE", "ALARM", "BFA", "TCFA", "79LOA", "TCC", "PUA", "51P", "51N", "46", "50P-1", "50N-1", "50P-2", "50N-2", "50P-3", "50N-3", "PATA", "PBTA", "PCTA", "67P", "67N", "81S-1", "81R-1", "81O-1", "27-1P", "59", "79DA", "79CA1", "OCTC", "KSI", "PDA", "NDA", "PVArA", "NVArA", "LOADA", "50-1D", "LPFA", "HPFA", "ZSC", "50-2D", "BFUA", "STCA", "PH3-D", "GRD-D", "32PA", "32NA", "27-3P", "VarDA", "79CA2", "TRIPA", "TRIPB", "TRIPC", "27-1P*", "46*", "50P-1*", "50N-1*", "50P-2*", "50N-2*", "50P-3*", "50N-3*", "51P*", "51N*", "59*", "67P*", "67N*", "81S-1*", "81R-1*", "81O-1*", "27-3P*", "TRIPA*", "TRIPB*", "TRIPC*", "ULO1", "ULO2", "ULO3", "ULO4", "ULO5", "ULO6", "ULO7", "ULO8", "ULO9", "81O-2", "81S-2", "81R-2", "81O-2*", "81S-2*", "81R-2*", "CLTA", /* V1.40 */ "PWatt1", "PWatt2", "79CA1*", "79CA2*".

The following were added to CPU V1.60: "SEF*(Sensitive Earth Model), "SEF"(Sensitive Earth Model), "BZA", "BFT", "ReTrp", "BFT*", "ReTrp*". The following were added to CPU V1.80: "32P-2", "32N-2", "32P-2*", "32N-2*", "BFA*".

The following were added to CPU V1.93: "25*(Synch Check Model), "25"(Synch Check Model), "SBA".

The following were added to CPU V3.20: "79V"and "RClIn", "59G", "59G*", "LO1", "LO2", "LO3", "LO4", "LO5", "LO6", "LO7", "LO8", "TR_ON", "TR_OFF", "TR_TAG".

The following were added to CPU V5.0: 59-3P, 59-3P*, 47, 47*, 21P-1, 21P-1*, 21P-2, 21P-2*, 21P-3, 21P-3*, 21P-4, 21P-4*.

Logical Output List for DPU1500R - Requires matrix (31 x 6) to allow user to map 31 Logical Outputs to 6 Physical Outputs.

NOTE: first logical, **TRIP** is fixed, user is not permitted to remove Trip logical from the list. Also note, since the **CLOSE** logical is specific to DPU2000, mapping of this logical (located at bit 1) is NOT permissible. Logical Outputs include: "TRIP", "CLOSE", "ALARM", "BFA", "TCFA", "79LOA", "TCC", "PUA", "51P", "51N", "46", "50P-1", "50N-1", "50P-2", "50N-2", "50P-3", "50N-3", "PATA", "PBTA", "PCTA", "27-1P", "79DA", "79CA1", "OCTC", "KSI", "PDA", "NDA", "PVArA", "NVArA", "LOADA", "50-1D", "LPFA", "HPFA", "ZSC", "50-2D", "BFUA", "STCA", "PH3-D", "GRD-D", "27-3P", "VarDA", "79CA2", "TRIPA", "TRIPB", "TRIPC", "27-1P*", "46*", "50P-1*", "50N-1*", "50P-2*", "50N-2*", "50P-3*", "50N-3*", "51P*", "51N*", "27-3P*", "TRIPA*", "TRIPB*", "TRIPC*", "CLTA", "PWatt1", "PWatt2", "79CA1*", "79CA2*", "SEF*(Sensitive Earth Model), "SEF"(Sensitive Earth Model), "BZA", "BFA*", "SBA", "79V" and "RClIn".

Below is the complete listing of Logical Output Offsets and their respective definitions.

<u>Index</u>	<u>Logical Output</u>	<u>Definitions</u>
00	TRIP	Fixed Trip
01	CLOSE	Fixed Close (DPU2000)
02	Alarm	Self Check Alarm
03	27-1P	Single Phase Under Voltage
04	46	Negative Sequence Overcurrent
05	50P-1	Phase Inst Overcurrent
06	50N-1	Neutral Inst Overcurrent
07	50P-2	Phase Inst Overcurrent

08	50N-2	Neutral Inst Overcurrent
09	50P-3	Phase Inst Overcurrent
10	50N-3	Neutral Inst Overcurrent
11	51P	Phase Time Overcurrent
12	51N	Neutral Time Overcurrent
13	59	Over Voltage
14	67P	Directional Overcurrent (pos seq)
15	67N	Directional Overcurrent (neg seq)
16	81S-1	Frequency Shed (First stage)
17	81R-1	Frequency Restore (First stage)
18	PATA	Phase A Target
19	PATB	Phase B Target
20	PATC	Phase C Target
21	TCFA	Trip Circuit Fail
22	TCC	Tap Changer Cutout
23	79DA	Recloser Disable
24	PUA	Pickup
25	79LOA	Recloser Lockout
26	BFA	Breaker Fail
27	PDA	Phase Peak Demand
28	NDA	Neutral Peak Demand
29	BFUA	Blown Fuse
30	KSI	KiloAmp Summation
31	79CA-1	Reclose Counter1
32	HPFA	High Power Factor
33	LPFA	Low Power Factor
34	OCTC	Overcurrent Trip Counter
35	50-1D	50-1 Element Disable
36	50-2D	50-2 Element Disable
37	STC	Setting Table Change
38	ZSC	Zone Sequence
39	PH3-D	Phase Torque Control Disable
40	GRD-D	Neutral Torque Control Disable
41	32PA	Directional Pickup (pos seq)
42	32NA	Directional Pickup (neg seq)
43	27-3P	3 Phase Under Voltage
44	VarDA	Var Demand
45	79CA-2	Reclose Counter2
46	TRIPA	Single Pole Trip Phase A
47	TRIPB	Single Pole Trip Phase B
48	TRIPC	Single Pole Trip Phase C
49	27-1P*	Single Phase Under Voltage
50	46*	Negative Sequence Overcurrent
51	50P-1*	Phase Inst Overcurrent
52	50N-1*	Neutral Inst Overcurrent
53	50P-2*	Phase Inst Overcurrent
54	50N-2*	Neutral Inst Overcurrent
55	50P-3*	Phase Inst Overcurrent
56	50N-3*	Neutral Inst Overcurrent
57	51P*	Phase Time Overcurrent
58	51N*	Neutral Time Overcurrent
59	59*	Over Voltage
60	67P*	Directional Overcurrent (pos seq)
61	67N*	Directional Overcurrent (neg seq)
62	81S-1*	Frequency Shed (First stage)
63	81R-1*	Frequency Restore (First stage)
64	81O-1*	Over Frequency (First stage)
65	27-3P*	3 Phase Under Voltage
66	TRIPA*	Single Pole Trip Phase A

67	TRIPB*	Single Pole Trip Phase B
68	TRIPC*	Single Pole Trip Phase C
69	ULO1	User Logical Output 1
70	ULO2	User Logical Output 2
71	ULO3	User Logical Output 3
72	ULO4	User Logical Output 4
73	ULO5	User Logical Output 5
74	ULO6	User Logical Output 6
75	ULO7	User Logical Output 7
76	ULO8	User Logical Output 8
77	ULO9	User Logical Output 9
78	PVArA	Positive VAr
79	NVArA	Negative VAr
80	LOADA	Load Current
81	81O-1	Over Frequency (First Stage)
82	81O-2	Over Frequency (2nd Stage)
83	81S-2	Frequency Shed (2nd Stage)
84	81R-2	Frequency Restore (2nd Stage)
85	81O-2*	Over Frequency (2nd Stage)
86	81S-2*	Frequency Shed (2nd Stage)
87	81R-2*	Frequency Restore (2nd Stage)
88	CLTA	Cold Load Timer
89	PWatt1	Positive Watt Alarm 1
90	PWatt2	Positive Watt Alarm 2
91	79CA1*	Recloser Counter 1 Alarm
92	79CA2*	Recloser Counter 2 Alarm
93	SEF*	Sensitive Earth Fault Trip
94	SEF	Sensitive Earth Fault Trip
95	BZA	Bus Zone Alarm
96	BFT	Breaker Failure Trip Alarm
97	RETRIP	Breaker Failure Re-Trip Alarm
98	BFT*	Breaker Failure Trip Alarm
99	RETRIP*	Breaker Failure Re-Trip Alarm
100	32P-2	Phase Power Directional Alarm
101	32N-2	Neutral Power Directional Alarm
102	32P-2*	Phase Power Directional Alarm
103	32N-2*	Neutral Power Directional Alarm
104	BFA*	Breaker Failure Alarm Seal in
105	25*	Synch Check Alarm Seal in
106	25	Synch Check Alarm
107	SBA	Slow Breaker Alarm
108	79V	
109	Rclin	
110	59G	V0 Over Voltage
111	59G*	V0 Over Voltage SEAL-IN
112	LO1	Latching logical output 1
113	LO2	Latching logical output 2
114	LO3	Latching logical output 3
115	LO4	Latching logical output 4
116	LO5	Latching logical output 5
117	LO6	Latching logical output 6
118	LO7	Latching logical output 7
119	LO8	Latching logical output 8
120	TR_ON	Hot hold tagging On
121	TR_OFF	Hot hold tagging Off
122	TR_TAG	Hot hold tagging Tag
123	59-3P	3-Phase Over-voltage alarm
124	59-3P*	3-Phase Over-voltage seal-in alarm
125	47	Negative sequence over-voltage alarm

126	47*	Negative sequence over-voltage seal-in alarm
127	spare	Not used.
128	21P-1	Forward reach Zone 1 Distance alarm
129	21P-1*	Forward reach Zone 1 Distance seal-in alarm
130	21P-2	Forward reach Zone 2 Distance alarm
131	21P-2*	Forward reach Zone 2 Distance seal-in alarm
132	21P-3	Forward reach Zone 3 Distance alarm
133	21P-3*	Forward reach Zone 3 Distance seal-in alarm
134	21P-4	Forward reach Zone 4 Distance alarm
135	21P-4*	Forward reach Zone 4 Distance seal-in alarm

NOTE: SEF, SEF*, and BZA logical outputs are available in Sensitive Earth model only. Also, * indicates sealed in outputs.

<u>Msg byte</u>	<u>Definition</u>
1/1	Most significant high byte of password
1/2	Most significant low byte of password
1/3	Least significant high byte of password
2/1	Least significant low byte of password
2/2	spare
2/3	Command + Subcommand = 0xb6
3/1	spare (bits 24-31)
3/2	spare (bits 16-23)
3/3	Programmable output AND/OR selection bits 8-15
4/1	Programmable output AND/OR selection bits 0-7
4/2	OUTPUT1 index byte
4/3	OUTPUT2 index byte
5/1	OUTPUT3 index byte
5/2	OUTPUT4 index byte
5/3	OUTPUT5 index byte
6/1	OUTPUT6 index byte
6/2	OUTPUT7 index byte
6/3	OUTPUT8 index byte
7/1	OUTPUT9 index byte
7/2	OUTPUT10 index byte
7/3	OUTPUT11 index byte
8/1	OUTPUT12 index byte
8/2	OUTPUT13 index byte
8/3	OUTPUT14 index byte
9/1	OUTPUT15 index byte
9/2	OUTPUT16 index byte
9/3	OUTPUT17 index byte
10/1	OUTPUT18 index byte
10/2	OUTPUT19 index byte
10/3	OUTPUT20 index byte
11/1	OUTPUT21 index byte
11/2	OUTPUT22 index byte
11/3	OUTPUT23 index byte
12/1	OUTPUT24 index byte
12/2	OUTPUT25 index byte
12/3	OUTPUT26 index byte
13/1	OUTPUT27 index byte
13/2	OUTPUT28 index byte
13/3	OUTPUT29 index byte
14/1	OUTPUT30 index byte
14/2	Checksum high byte
14/3	Checksum low byte

<u>Bit</u>	<u>Logical Output</u>
0	TRIP
1	CLOSE (This bit available for mapping in DPU2000 only)
2	OUTPUT1
3	OUTPUT2
.	.
.	.
30	OUTPUT29
31	OUTPUT30

5.9.7 Receive Programmable Output User Defined Names (3 11 7)

User definable 8 char output strings. Byte 9 is an implied NULL.

<u>Msg byte</u>	<u>Definition</u>
1/1	Most significant high byte of password
1/2	Most significant low byte of password
1/3	Least significant high byte of password
2/1	Least significant low byte of password
2/2	spare
2/3	Command + Subcommand = 0xb7
3/1-5/2	OUT1 Character String 8 bytes
5/3-8/1	OUT2 Character String 8 bytes
8/2-10/3	OUT3 Character String 8 bytes
11/1-13/2	OUT4 Character String 8 bytes
13/3-16/1	OUT5 Character String 8 bytes
16/2-18/3	OUT6 Character String 8 bytes
19/1-21/2	OUT7 Character String 8 bytes (DPU2000)
21/3-24/1	OUT8 Character String 8 bytes (DPU2000)
24/2-26/3	Spare Character String 8 bytes
27/1-29/2	Spare Character String 8 bytes
29/3-32/1	Spare Character String 8 bytes
32/2-34/3	Spare Character String 8 bytes
35/1-37/2	Spare Character String 8 bytes
37/3-40/1	Spare Character String 8 bytes
40/2	Checksum high byte
40/3	Checksum low byte

5.9.8 Receive Relay Settings (3 11 x)

- (3 11 8) = Primary Settings
- (3 11 9) = Alternate 1 Settings
- (3 11 10) = Alternate 2 Settings
- Low byte consists of bits 0 through 7.
- High byte consists of bits 8 through 15.

The following functions are available in the DPU1500R: 51P, 50P-1, 50P-2, 50P-3, 46, 51N, 50N-1, 50N-2, 50N-3, 79 and 27.

5.9.8.1 Standard ANSI Curves for DPU2000 and DPU2000R

<u>Curve Selection Type I</u>	<u>Curve Type II</u>
0 = Extremely Inverse	0 = Extremely Inverse
1 = Very Inverse	1 = Very Inverse
2 = Inverse	2 = Inverse
3 = Short Time Inverse	3 = Short Time Inverse
4 = Definite Time	4 = Definite Time
5 = Long Time Extremely Inverse	5 = Long Time Extremely Inverse
6 = Long Time Very Inverse	6 = Long Time Very Inverse
7 = Long Time Inverse	7 = Long Time Inverse

- | | |
|--------------------|--------------------|
| 8 = Recloser Curve | 8 = Recloser Curve |
| 9 = User Curve 1 | 9 = Disable |
| 10 = User Curve 2 | 10 = User Curve 1 |
| 11 = User Curve 3 | 11 = User Curve 2 |
| | 12 = User Curve 3 |

Curve Selection Type III

- 0 = Disable
- 1 = Standard
- 2 = Inverse
- 3 = Definite Time
- 4 = Short Time Inverse
- 5 = Short Time Extremely Inverse
- 6 = User Curve 1
- 7 = User Curve 2
- 8 = User Curve 3

5.9.8.2 Recloser Curves for DPU2000 and DPU2000R

NOTE: Catalog Numbers XXXXXXXX-XX2XX and XXXXXXXX-XX3XX use the following curve types for 51P, 50P-1, 51N, and 50N-1 functions. Also, in addition to the Time Dial fields, include 51P, 50P-1, 51N and 50N-1 Minimum Response fields.

Recloser Curve (51P)

- 0 = A
- 1 = B
- 2 = C
- 3 = D
- 4 = E
- 5 = K
- 6 = N
- 7 = R
- 8 = W
- 9 = User Curve 1
- 10 = User Curve 2
- 11 = User Curve 3

Recloser Curve (51N)

- 0 = 2
- 1 = 3
- 2 = 8
- 3 = 8*
- 4 = 8+
- 5 = 9
- 6 = 11
- 7 = Disable
- 8 = User Curve 1
- 9 = User Curve 2
- 10 = User Curve 3

Recloser Curve (50P-1)

- 0 = Disable
- 1 = A
- 2 = B
- 3 = C
- 4 = D
- 5 = E
- 6 = K
- 7 = N
- 8 = R
- 9 = W
- 10 = User Curve 1
- 11 = User Curve 2
- 12 = User Curve 3

Recloser Curve (50N-1)

- 0 = Disable
- 1 = 2
- 2 = 3
- 3 = 8
- 4 = 8*
- 5 = 8+
- 6 = 9
- 7 = 11
- 8 = User Curve 1
- 9 = User Curve 2
- 10 = User Curve 3

5.9.8.3 IEC Curves for DPU2000R

NOTE: The following curves are available in IEC DPU2000R, Catalog Number 687XXXXX-XXXXX. All IEC type curves except Definite Time Curves, use Time Multipliers in place of Time Dials.

IEC Curve Selection Type I

- 0 = Extremely Inverse
- 1 = Very Inverse
- 2 = Inverse
- 3 = Long Time Inverse
- 4 = Definite Time

IEC Curve Type II

- 0 = Disabled
- 1 = Extremely Inverse
- 2 = Very Inverse
- 3 = Inverse
- 4 = Long Time Inverse

- | | |
|------------------|-------------------|
| 5 = User Curve 1 | 5 = Definite Time |
| 6 = User Curve 2 | 6 = User Curve 1 |
| 7 = User Curve 3 | 7 = User Curve 2 |
| | 8 = User Curve 3 |

IEC Curve Selection Type III

- 0 = Disable
- 1 = Standard
- 2 = Definite Time
- 3 = User Curve 1
- 4 = User Curve 2
- 5 = User Curve 3

5.9.8.4 ANSI/IEC Curves for DPU1500R

NOTE: All IEC type curves, use Time Multipliers in place of Time Dials.

Curve Selection Type I

- 0 = Extremely Inverse
- 1 = Very Inverse
- 2 = Inverse
- 3 = Short Time Inverse
- 4 = Definite Time
- 5 = Long Time Extremely Inverse
- 6 = Long Time Very Inverse
- 7 = Long Time Inverse
- 8 = Recloser Curve
- 9 = IEC Extremely Inverse
- 10 = IEC Very Inverse
- 11 = IEC Inverse
- 12 = IEC Long Time Inverse
- 13 = User Curve 1
- 14 = User Curve 2
- 15 = User Curve 3

Curve Type II

- 0 = Extremely Inverse
- 1 = Very Inverse
- 2 = Inverse
- 3 = Short Time Inverse
- 4 = Definite Time
- 5 = Long Time Extremely Inverse
- 6 = Long Time Very Inverse
- 7 = Long Time Inverse
- 8 = Recloser Curve
- 9 = Disable
- 10 = IEC Extremely Inverse
- 11 = IEC Very Inverse
- 12 = IEC Inverse
- 13 = IEC Long Time Inverse
- 14 = User Curve 1
- 15 = User Curve 2
- 16 = User Curve 3

Curve Selection Type III

- 0 = Disable
- 1 = Standard
- 2 = Inverse
- 3 = Definite Time
- 4 = Short Time Inverse
- 5 = Short Time Extremely Inverse
- 6 = User Curve 1
- 7 = User Curve 2
- 8 = User Curve 3

5.9.8.5 79-X Select Bit Pattern for DPU2000/2000R/1500R

79 Lockout and Enable/Disable bit pattern

Low Byte: 0 = No Lockout/Disable, 1 = Enabled

High Byte: 0 = Enable, 1 = Lockout

- | | |
|-----------------|------------------|
| bit 0: 50N-1 | bit 8: 50N-1 |
| bit 1: 50N-2 | bit 9: 50N-2 |
| bit 2: 50N-3 | bit 10: 50N-3 |
| bit 3: 51N | bit 11: 51N |
| bit 4: 50P-1 | bit 12: 50P-1 |
| bit 5: 50P-2 | bit 13: 50P-2 |
| bit 6: 50P-3 | bit 14: 50P-3 |
| bit 7: Reserved | bit 15: Reserved |

<u>Msg byte</u>	<u>Definition</u>
1/1	Most significant high byte of password
1/2	Most significant low byte of password
1/3	Least significant high byte of password
2/1	Least significant low byte of password
2/2	spare
2/3	Command + Subcommand = (Prim=0xb8, Alt1=0xb9, Alt2=0xba)
3/1	51P Curve Select byte (Type I or Recloser)
3/2	51P Pickup Amps byte (1-12Amp *10, 0.2-2.4Amp *50)
3/3	51P Time dial(0.05-1*200)/delay byte(0-10 *20) IEC Curve -51P Time Multiplier (.05-1.00 *200)
4/1	50P-1 Curve Select byte (Type III or Recloser)
4/2	50P-1 Pickup X byte (0.5-20 *10)
4/3	50P-1 Timedial(1-10*10)/delay(0-9.99*100)high byte IEC Curve -50P-1 Time Multiplier (.05-1.00 *200)
5/1	50P-1 Timedial/delay low byte
5/2	50P-2 Select byte (0=Disable, 1=Enable)
5/3	50P-2 Pickup X byte (0.5-20 *10)
6/1	50P-2 Timedelay high byte (0-9.99 *100)
6/2	50P-2 Timedelay low byte
6/3	50P-3 Select byte (0=Disable, 1=Enable)
7/1	50P-3 Pickup X byte (0.5-20 *10)
7/2	46 Curve Select byte (Type II)
7/3	46 Pickup Amps byte (1-12Amp *10, 0.2-2.4Amp *50)
8/1	46 Time dial(1-10 *20)/delay byte(0-10 * 20) IEC Curve -46 Time Multiplier (.05-1.00 *200)
8/2	51N Curve Select byte (Type II or Recloser)
8/3	51N Pickup Amps byte (1-12Amp *10, 0.2-2.4Amp *50)
9/1	51N Time dial(1-10 *20)/delay byte(0-10 * 20) IEC Curve -51N Time Multiplier (.05-1.00 *200)
9/2	50N-1 Curve Select byte (Type III or Recloser)
9/3	50N-1 Pickup X byte (0.5-20 *10)
10/1	50N-1 Timedial(1-10*10)/delay(0-9.99*100)high byte
10/2	50N-1 Timedial/delay low byte
10/3	50N-2 Select byte (0=Disable, 1=Enable) Sensitive Earth Model (0=Disable, 1=Standard, 2=SEF, 3=Directional SEF)
11/1	50N-2 Pickup X byte (0.5-20 *10)
11/2	50N-2 Timedelay high byte (0-9.99 *100) SEF or Directional SEF Selects - 50N-2 Time Delay (0.5 to 180.0)*200
11/3	50N-2 Timedelay low byte
12/1	50N-3 Select byte (0=Disable, 1=Enable)
12/2	50N-3 Pickup X byte (0.5-20 *10)
12/3	79 Reset Time byte (3-200)
13/1	79-1 Select high byte (Lockout Type)
13/2	79-1 Select low byte (Enable Type)
13/3	79-1 Open Interval Time high byte (0.1 - 200 *10, 2001 = Lockout) Sensitive Earth Model (0.1 to 1800 *10, 18001=Lockout)
14/1	79-1 Open Interval Time low byte
14/2	79-2 Select high byte (Lockout Type)
14/3	79-2 Select low byte (Enable Type)
15/1	79-2 Open Interval Time high byte (0.1 - 200 *10, 2001 = Lockout) Sensitive Earth Model (0.1 to 1800 *10, 18001=Lockout)
15/2	79-2 Open Interval Time low byte
15/3	79-3 Select high byte (Lockout)
16/1	79-3 Select low byte (Enable)
16/2	79-3 Open Interval Time high byte (0.1 - 200 *10, 2001 = Lockout) Sensitive Earth Model (0.1 to 1800 *10, 18001=Lockout)
16/3	79-3 Open Interval Time low byte

17/1	79-4 Select high byte (Lockout Type)
17/2	79-4 Select low byte (Enable Type)
17/3	79-4 Open Interval Time high byte (0.1 - 200 *10, 2001 = Lockout) Sensitive Earth Model (0.1 to 1800 *10, 18001=Lockout)
18/1	79-4 Open Interval Time low byte
18/2	79-5 Select high byte (Lockout Type)
18/3	79-5 Select low byte (Enable Type)
19/1	79-5 Open Interval Time high byte (always lockout)
19/2	79-5 Open Interval Time low byte
19/3	79 Cutout Time byte (1 -201) (201 = Disable)
20/1	Cold Load Time byte (1 -254) (255 = Disable)
20/2	2 Phase Voting byte (0=Disable, 1=Enable)
20/3	67P Select byte (0=Disable, 1=Enable, 2=Lockout)
21/1	67P Curve Select byte (Type I)
21/2	67P Pickup Amps byte (1-12Amp *10, 0.2-2.4Amp *50)
21/3	67P Time dial(1-10 *20)/delay(0-10 * 20) byte IEC Curve -67P Time Multiplier (.05-1.00 *200)
22/1	67P Torque Angle byte (0-355 /5)
22/2	67N Select byte (0=Disable, 1=Enable, 2=Lockout) Sensitive Earth Model (0=Disable, 1=Enable-Neg Sequence, 2=Lockout-Neg Sequence, 5=Enable-Pos Sequence, 6=Lockout Pos Sequence)
22/3	67N Curve Select byte (Type I)
23/1	67N Pickup Amps byte (1-12Amp *10, 0.2-2.4Amp *50)
23/2	67N Time dial(1-10 *20)/delay(0-10 * 20) byte IEC Curve -67N Time Multiplier (.05-1.00 *200)
23/3	67N Torque Angle byte (0-355 /5)
24/1	81 Select byte (0=Disable, 1=81-1, 2=81-2, 3=Special)
24/2	81s-1 Pickup Frequency high byte (60hz: 56-64 *100, 6401=Disable 50hz: 46-54 *100, 5401=Disable)
24/3	81s-1 Pickup Frequency low byte
25/1	81s-1 Timedelay high byte (0.08-9.98 *100)
25/2	81s-1 Timedelay low byte
25/3	81r-1 Pickup Frequency high byte (60hz: 56-64 *100, 6401=Disable 50hz: 46-54 *100, 5401=Disable)
26/1	81r-1 Pickup Frequency low byte
26/2	81r-1 Timedelay high byte (0-999)
26/3	81r-1 Timedelay low byte
27/1	81v Voltage Block high byte (40-200)
27/2	81v Voltage Block low byte
27/3	27 Select byte (0=Disable, 1=Enable)
28/1	27 Pickup Voltage high byte (10-200)
28/2	27 Pickup Voltage low byte
28/3	27 Timedelay byte (0-60)
29/1	79v Select byte (0=Disable, 1=Enable)
29/2	79v Pickup Voltage high byte (10-200)
29/3	79v Pickup Voltage low byte
30/1	79v Timedelay byte (4-200)
30/2	59 Select byte (0=Disable, 1=Enable)
30/3	59 Pickup Voltage high byte (70-250)
31/1	59 Pickup Voltage low byte
31/2	59 Timedelay byte (0-60)
31/3	51 P Minimum Response (0 - 60 cycles)
32/1	51 N Minimum Respons (0 - 60 cycles)
32/2	50 P-1 Minimum Response (0 - 60 cycles)
32/3	50 N-1 Minimum Response (0 - 60 cycles)
33/1	Unit Configuration byte(for transmit only)
33/2	81s-2 Pickup Frequency high byte (60hz: 56-64 *100, 6401=Disable 50hz: 46-54 *100, 5401=Disable)
33/3	81s-2 Pickup Frequency low byte

34/1	81s-2 Timedelay high byte (0.08-9.98 *100)
34/2	81s-2 Timedelay low byte
34/3	81r-2 Pickup Frequency high byte (60hz: 56-64 *100, 6401=Disable 50hz: 46-54 *100, 5401=Disable)
35/1	81r-2 Pickup Frequency low byte
35/2	81r-2 Timedelay high byte (0-999)
35/3	81r-2 Timedelay low byte
36/1	Sensitive Earth Model - SEF Torque Angle (0-355 /5)
36/2	Sensitive Earth Model - SEF 50N-2 Pickup mA high byte (10-400)/2
36/3	Sensitive Earth Model - SEF 50N-2 Pickup mA low byte
37/1	Sensitive Erth Model neutral cold load time(1-254)(255= disable)
37/2	Checksum high byte
37/3	Checksum low byte

5.9.9 Receive Configuration Settings (3 11 11)

Low byte consists of bits 0 through 7.

High byte consists of bits 8 through 15.

<u>Msg byte</u>	<u>Definition</u>
1/1	Most significant high byte of password
1/2	Most significant low byte of password
1/3	Least significant high byte of password
2/1	Least significant low byte of password
2/2	spare
2/3	Command + Subcommand = 0xbb
3/1	Phase CT Ratio high byte (1-999 DPU2000, 1-2000 DPU2000R/1500R)
3/2	Phase CT Ratio low byte
3/3	Neutral CT Ratio high byte (1-999 DPU2000, 1-2000 DPU2000R)
4/1	Neutral CT Ratio low byte
4/2	VT Ratio high byte (1-999 DPU2000, 1-2000 DPU2000R/1500R)
5/1	VT Connection high byte
5/2	VT Connection low byte (0=69V Wye, 1=120V Wye, 2=120V Delta, 3=208V Delta, 4=69V Wye 3V0 I, 5=120V Wye 3V0 I)
5/3	Positive Sequence Reactance high byte (1-4 *1000)
6/1	Positive Sequence Reactance low byte
6/2	Positive Sequence Resistance high byte (1-4 *1000)
6/3	Positive Sequence Resistance low byte
7/1	Zero Sequence Reactance high byte (1-4 *1000)
7/2	Zero Sequence Reactance low byte
7/3	Zero Sequence Resistance high byte (1-4 *1000)
8/1	Zero Sequence Resistance low byte
8/2	Distance in Miles high byte (0.1-50 *10)
8/3	Distance in Miles low byte
9/1	Trip Failure Time high byte(5-60)
9/2	Trip Failure Time low byte
9/3	Close Failure Time high byte(18-999)
10/1	Close Failure Time low byte
10/2	Phase Rotation high byte (0=ABC, 1=ACB)
10/3	Phase Rotation low byte
11/1	Configuration Flag high byte
11/2	Configuration Flag low byte bit 0: Protection Mode (0=Fund, 1=RMS) bit 1: Reset Mode (0=Instant, 1=Delayed) bit 2: Zone Sequence (0=Disabled, 1=Enabled) bit 3: Target Display Mode (0=Last, 1=All) bit 4: Local Edit (0=Disabled, 1=Enabled) bit 5: Reserved (Remote Edit, 0=Disabled, 1=Enabled) bit 6: WHr/VarHr Mtr Mode (0=KWHr, 1=MWHr) bit 7: LCD Light (0=Timer, 1=On)

	bit 8: Multi Device Trip (0=Disabled, 1=Enabled)
	bit 9: VCN Special Mode (0=Normal, 1=Inverted)
	bit10: Cold Load Timer Mode(0=Seconds, 1=Minutes)
	bit11: Reserved
	bit 12: 79V Timer Mode (0= sec., 1=min.)
	bit 13: Voltage Display Mode (0= vln, 1=VII)
	bit 14: Reserved
11/3	ALT 1 Setting Enable high byte(0=Disable,1=Enable)
12/1	ALT 1 Setting Enable low byte
12/2	ALT 2 Setting Enable high byte(0=Disable,1=Enable)
12/3	ALT 2 Setting Enable low byte
13/1	Demand Time Constant high byte
13/2	Demand Time Constant low byte (0=5 min, 1=15 min, 2=30 min, 3=60 min)
13/3	Sensitive Earth CT Ratio high byte (1-2000)
14/1	Sensitive Earth CT Ratio low byte
14/2-19/1	Unit Name character 1-15
19/2	Spare
19/3	Sensitive Earth V0 PT Ratio high byte (1-2000)
20/1	Sensitive Earth V0 PT Ratio low byte
20/2	Spare
20/3	Spare
21/1	LCD Contrast Adjustment high byte(0-63)
21/2	LCD Contrast Adjustment low byte
21/3	Relay Password character 1
22/1	Relay Password character 2
22/2	Relay Password character 3
22/3	Relay Password character 4
23/1	Test Password character 1
23/2	Test Password character 2
23/3	Test Password character 3
24/1	Test Password character 4
24/2	Checksum high byte
24/3	Checksum low byte

5.9.10 Receive Counter Settings (3 11 12)

NOTE: This command is used in versions prior to CPU V1.41.

Low byte consists of bits 0 through 7.

High byte consists of bits 8 through 15.

<u>Msg byte</u>	<u>Definition</u>
1/1	Most significant high byte of password
1/2	Most significant low byte of password
1/3	Least significant high byte of password
2/1	Least significant low byte of password
2/2	spare
2/3	Command + Subcommand = 0xbc
3/1	KSI Sum A Counter high byte
3/2	KSI Sum A Counter low byte
3/3	KSI Sum B Counter high byte
4/1	KSI Sum B Counter low byte
4/2	KSI Sum C Counter high byte
4/3	KSI Sum C Counter low byte
5/1	Over Current Trip Counter high byte
5/2	Over Current Trip Counter low byte
5/3	Breaker Operations Counter high byte
6/1	Breaker Operations Counter low byte
6/2	Reclose Counter 1 high byte
6/3	Reclose Counter 1 low byte
7/1	1st Reclose Counter high byte

7/2	1st Reclose Counter low byte
7/3	2nd Reclose Counter high byte
8/1	2nd Reclose Counter low byte
8/2	3rd Reclose Counter high byte
8/3	3rd Reclose Counter low byte
9/1	4th Reclose Counter high byte
9/2	4th Reclose Counter low byte
9/3	Reclose Counter 2 high byte
10/1	Reclose Counter 2 low byte
10/2	Checksum high byte
10/3	Checksum low byte

5.9.11 Receive Alarm Settings (3 11 13)

Low byte consists of bits 0 through 7.

High byte consists of bits 8 through 15.

<u>Msg byte</u>	<u>Definition</u>
1/1	Most significant high byte of password
1/2	Most significant low byte of password
1/3	Least significant high byte of password
2/1	Least significant low byte of password
2/2	spare
2/3	Command + Subcommand = 0xbd
3/1	KSI Summation Alarm Threshold high byte (1-9999,10000=Disables)
3/2	KSI Summation Alarm Threshold low byte
3/2	Overcurrent Trip Counter Alarm Threshold high byte (1-9999,10000=Disables)
4/1	Overcurrent Trip Counter Alarm Threshold low byte
4/2	Reclosure Counter 1 Alarm Threshold high byte (1-9999,10000=Disables)
4/3	Reclosure Counter 1 Alarm Threshold low byte
5/1	Phase Demand Alarm high byte (1-9999,10000=Disables)
5/2	Phase Demand Alarm low byte
5/3	Neutral Demand Alarm high byte (1-9999,10000=Disables)
6/1	Neutral Demand Alarm low byte
6/2	Low PF Alarm high byte (0.5-1.0 *100, 101=Disables)
6/3	Low PF Alarm low byte
7/1	High PF Alarm high byte (0.5-1.0 *100, 101=Disables)
7/2	High Pf Alarm low byte
7/3	Reclosure Counter 2 Alarm Threshold high byte (1-9999,10000=Disables)
8/1	Reclosure Counter 2 Alarm Threshold low byte
8/2	3 Phase kVAR Alarm Threshold high byte (10-99990 /10,10000=Disables)
8/3	3 Phase kVAR Alarm Threshold low byte
9/1	Load Current Alarm high byte (1-9999,10000=Disables)
9/2	Load Current Alarm low byte
9/3	Positive kVAR Alarm high byte (10-99990 /10,10000=Disable)
10/1	Positive kVAR Alarm low byte
10/2	Negative kVAR Alarm high byte (10-99990 /10,10000=Disable)
10/3	Negative kVAR Alarm low byte
11/1	Pos Watt Alarm 1 high byte (1-9999, 10000=Disable)
11/2	Pos Watt Alarm 1 low byte
11/3	Pos Watt Alarm 2 high byte (1-9999, 10000=Disable)
12/1	Pos Watt Alarm 2 low byte
12/2	Spare
12/3	Spare
13/1	Spare
13/2	Spare
13/3	Spare
14/1	Spare
14/2	Checksum high byte
14/3	Checksum low byte

NOTE: Positive Watt Alarm 1 and Positive Watt Alarm 2 units are displayed in either KWhr or MWhr according to bit 6 of Configuration Flag (Command 3 4 11, message 10/2). If bit is set to one, use MWhr, if bit is zero, use KWhr.

5.9.12 Receive Real Time Clock (3 11 14)

<u>Msg byte</u>	<u>Definition</u>
1/1	Most significant high byte of password
1/2	Most significant low byte of password
1/3	Least significant high byte of password
2/1	Least significant low byte of password
2/2	spare
2/3	Command + Subcommand = 0xbe
3/1	Hours byte (0-23)
3/2	Minutes byte (0-59)
3/3	Seconds byte (0-59)
4/1	Day byte (0-31) (0= Clock Shutdown)
4/2	Month byte (1-12)
4/3	Year byte (0-99)
5/1	spare
5/2	Checksum high byte
5/3	Checksum low byte

5.9.13 Receive Programmable Output Delays (3 11 15)

<u>Msg Byte</u>	<u>Definition</u>
1/1	Most significant high byte of password
1/2	Most significant low byte of password
1/3	Least significant high byte of password
2/1	Least significant low byte of password
2/2	Spare
2/3	Command + Subcommand = 0xbf
3/1	OUT 6 delay high byte
3/2	OUT 6 delay low byte
3/3	OUT 4 delay high byte
4/1	OUT 4 delay low byte
4/2	OUT 5 delay high byte
4/3	OUT 5 delay low byte
5/1	OUT 3 delay high byte
5/2	OUT 3 delay low byte
5/3	OUT 2 delay high byte
6/1	OUT 2 delay low byte
6/2	OUT 1 delay high byte
6/3	OUT 1 delay low byte
7/1	OUT 7 delay high byte (DPU2000)
7/2	OUT 7 delay low byte
7/3	OUT 8 delay high byte (DPU2000)
8/1	OUT 8 delay low byte
8/2	Spare
8/3	Spare
9/1	Spare
9/2	Checksum high byte
9/3	Checksum low byte

5.10 Programmable Curve Commands (3 13 n)

<u>N</u>	<u>Definition</u>
0	Repeat Last Command
1	Receive Curve Parameters
2	Receive First Curve Data Set
3	Receive Next Curve Data Set

4	Receive Curve Pointer Table
5	Show Curve Parameters
6	Show Curve Data Set
7	Show Curve Pointer Table

5.10.1 Receive Curve Parameters (3 13 1)

For the unit to receive the curve data the following sequence of commands must be issued:

- 3 13 1 (Curve parameters)
- 3 13 2 (8 Alpha-Beta segments) block 0
- 3 13 3 (8 Alpha-Beta segments) block 1
- 3 13 3 (8 Alpha-Beta segments) block 2
- 3 13 3 (8 Alpha-Beta segments) block 3
- 3 13 3 (8 Alpha-Beta segments) block 4
- 3 13 3 (8 Alpha-Beta segments) block 5
- 3 13 3 (8 Alpha-Beta segments) block 6
- 3 13 4 (60 pointer offsets)

<u>Data Byte</u>	<u>Definition</u>
1/1	Most significant high byte of password
1/2	Most significant low byte of password
1/3	Least significant high byte of password
2/1	Least significant low byte of password
2/2	Spare
2/3	Command + Subcommand = 0xd1
3/1	Programmable curve number
3/2	Coefficient A (high byte)
3/3	Coefficient A
4/1	Coefficient A
4/2	Coefficient A (low byte)
4/3	Coefficient B (high byte)
5/1	Coefficient B
5/2	Coefficient B
5/3	Coefficient B (low byte)
6/1	Coefficient C (high byte)
6/2	Coefficient C
6/3	Coefficient C
7/1	Coefficient C (low byte)
7/2	Coefficient P (high byte)
7/3	Coefficient P
8/1	Coefficient P
8/2	Coefficient P (low byte)
8/3	Spare
9/1	Spare
9/2	Checksum (high byte)
9/3	Checksum (low byte)

5.10.2 Receive First Curve Data Set (3 13 2)

<u>Data Byte</u>	<u>Definition</u>
1/1	Most significant high byte of password
1/2	Most significant low byte of password
1/3	Least significant high byte of password
2/1	Least significant low byte of password
2/2	Spare
2/3	Command + Subcommand = 0xd2
3/1	Programmable curve number
3/2	Segment 0: Endrange (high byte)
3/3	Segment 0: Endrange (low byte)
4/1	Segment 0: Alpha (high byte)

4/2	Segment 0: Alpha
4/3	Segment 0: Alpha
5/1	Segment 0: Alpha (low byte)
5/2	Segment 0: Beta (high byte)
5/3	Segment 0: Beta
6/1	Segment 0: Beta
6/2	Segment 0: Beta (low byte)
6/3-9/3	Segment 1 (same as segment 0)
10/1-13/1	Segment 2 (same as segment 0)
13/2-16/2	Segment 3 (same as segment 0)
16/3-19/3	Segment 4 (same as segment 0)
20/1-23/1	Segment 5 (same as segment 0)
23/2-26/2	Segment 6 (same as segment 0)
26/3-29/3	Segment 7 (same as segment 0)
30/1	Spare
30/2	Checksum (high byte)
30/3	Checksum (low byte)

5.10.3 Receive Next Curve Data Set (3 13 3)

Same format as (3 13 2).

5.10.4 Receive Curve Pointer Table (3 13 4)

<u>Data Byte</u>	<u>Definition</u>
1/1	Most significant high byte of password
1/2	Most significant low byte of password
1/3	Least significant high byte of password
2/1	Least significant low byte of password
2/2	Spare
2/3	Command + Subcommand = 0xd4
3/1	Programmable curve number
3/2	Pointer offset 0
3/3	Pointer offset 1
4/1	Pointer offset 2
4/2	Pointer offset 3
4/3	Pointer offset 4
5/1	Pointer offset 5
5/2	Pointer offset 6
5/3	Pointer offset 7
6/1	Pointer offset 8
6/2	Pointer offset 9
6/3	Pointer offset 10
7/1	Pointer offset 11
7/2	Pointer offset 12
7/3	Pointer offset 13
8/1	Pointer offset 14
8/2	Pointer offset 15
8/3	Pointer offset 16
9/1	Pointer offset 17
9/2	Pointer offset 18
9/3	Pointer offset 19
10/1	Pointer offset 20
10/2	Pointer offset 21
10/3	Pointer offset 22
11/1	Pointer offset 23
11/2	Pointer offset 24
11/3	Pointer offset 25
12/1	Pointer offset 26
12/2	Pointer offset 27

12/3	Pointer offset 28
13/1	Pointer offset 29
13/2	Pointer offset 30
13/3	Pointer offset 31
14/1	Pointer offset 32
14/2	Pointer offset 33
14/3	Pointer offset 34
15/1	Pointer offset 35
15/2	Pointer offset 36
15/3	Pointer offset 37
16/1	Pointer offset 38
16/2	Pointer offset 39
16/3	Pointer offset 40
17/1	Pointer offset 41
17/2	Pointer offset 42
17/3	Pointer offset 43
18/1	Pointer offset 44
18/2	Pointer offset 45
18/3	Pointer offset 46
19/1	Pointer offset 47
19/2	Pointer offset 48
19/3	Pointer offset 49
20/1	Pointer offset 50
20/2	Pointer offset 51
20/3	Pointer offset 52
21/1	Pointer offset 53
21/2	Pointer offset 54
21/3	Pointer offset 55
22/1	Pointer offset 56
22/2	Pointer offset 57
22/3	Pointer offset 58
23/1	Pointer offset 59
23/2	Spare
23/3	Spare
24/1	Spare
24/2	Spare
24/3	Spare
25/1	Spare
25/2	Spare
25/3	Spare
26/1	Spare
26/2	Checksum (high byte)
26/3	Checksum (low byte)

5.10.5 Send Curve Parameters (3 13 5)

For the unit to receive the curve data the following sequence of commands must be issued:

- 3 13 5 (Curve parameters)
- 3 13 6 (8 Alpha-Beta segments) block 0
- 3 13 6 (8 Alpha-Beta segments) block 1
- 3 13 6 (8 Alpha-Beta segments) block 2
- 3 13 6 (8 Alpha-Beta segments) block 3
- 3 13 6 (8 Alpha-Beta segments) block 4
- 3 13 6 (8 Alpha-Beta segments) block 5
- 3 13 6 (8 Alpha-Beta segments) block 6
- 3 13 7 (60 pointer offsets)

<u>Data Byte</u>	<u>Definition</u>
1/1	Curve Number
1/2	Curve Number
1/3	Curve Number
<u>Msg Byte</u>	<u>Definition</u>
1/1	Relay Status (see command 3 4 1, msg 1/1)
1/2	Command + Subcommand = 0xd5
1/3	Total Number of Messages = 8
2/1	Coefficient A (high byte)
2/2	Coefficient A
2/3	Coefficient A
3/1	Coefficient A (low byte)
3/2	Coefficient B (high byte)
3/3	Coefficient B
4/1	Coefficient B
4/2	Coefficient B (low byte)
4/3	Coefficient C (high byte)
5/1	Coefficient C
5/2	Coefficient C
5/3	Coefficient C (low byte)
6/1	Coefficient P (high byte)
6/2	Coefficient P
6/3	Coefficient P
7/1	Coefficient P (low byte)
7/2	Spare
7/3	Spare
8/1	Spare
8/2	Checksum (high byte)
8/3	Checksum (low byte)

5.10.6 Send Curve Data Set (3 13 6)

<u>Data Byte</u>	<u>Definition</u>
1/1	Programmable curve number
1/2	Block number
1/3	Programmable curve number + Block number
<u>Msg Byte</u>	<u>Definition</u>
1/1	Relay Status (see command 3 4 1, msg 1/1)
1/2	Command + Subcommand = 0xd6
1/3	Total Number of Messages = 29
2/1	Programmable curve number
2/2	Block number
2/3	Segment 0: Endrange (high byte)
3/1	Segment 0: Endrange (low byte)
3/2	Segment 0: Alpha (high byte)
3/3	Segment 0: Alpha
4/1	Segment 0: Alpha
4/2	Segment 0: Alpha (low byte)
4/3	Segment 0: Beta (high byte)
5/1	Segment 0: Beta
5/2	Segment 0: Beta
5/3	Segment 0: Beta (low byte)
6/1-9/1	Segment 1 (same as segment 0)
9/2-12/2	Segment 2 (same as segment 0)
12/3-15/3	Segment 3 (same as segment 0)
16/1-19/1	Segment 4 (same as segment 0)
19/2-22/2	Segment 5 (same as segment 0)

22/3-25/3	Segment 6 (same as segment 0)
26/1-29/1	Segment 7 (same as segment 0)
29/2	Checksum (high byte)
29/3	Checksum (low byte)

5.10.7 Send Curve Pointer Table (3 13 7)

<u>Data Byte</u>	<u>Definition</u>
1/1	Programmable curve number
1/2	Programmable curve number
1/3	Programmable curve number

<u>Msg Byte</u>	<u>Definition</u>
1/1	Relay Status (see command 3 4 1, msg 1/1)
1/2	Command + Subcommand = 0xd7
1/3	Total Number of Messages = 25
2/1	Programmable curve number
2/2	Pointer offset 0
2/3	Pointer offset 1
3/1	Pointer offset 2
3/2	Pointer offset 3
3/3	Pointer offset 4
4/1	Pointer offset 5
4/2	Pointer offset 6
4/3	Pointer offset 7
5/1	Pointer offset 8
5/2	Pointer offset 9
5/3	Pointer offset 10
6/1	Pointer offset 11
6/2	Pointer offset 12
6/3	Pointer offset 13
7/1	Pointer offset 14
7/2	Pointer offset 15
7/3	Pointer offset 16
8/1	Pointer offset 17
8/2	Pointer offset 18
8/3	Pointer offset 19
9/1	Pointer offset 20
9/2	Pointer offset 21
9/3	Pointer offset 22
10/1	Pointer offset 23
10/2	Pointer offset 24
10/3	Pointer offset 25
11/1	Pointer offset 26
11/2	Pointer offset 27
11/3	Pointer offset 28
12/1	Pointer offset 29
12/2	Pointer offset 30
12/3	Pointer offset 31
13/1	Pointer offset 32
13/2	Pointer offset 33
13/3	Pointer offset 34
14/1	Pointer offset 35
14/2	Pointer offset 36
14/3	Pointer offset 37
15/1	Pointer offset 38
15/2	Pointer offset 39
15/3	Pointer offset 40
16/1	Pointer offset 41
16/2	Pointer offset 42

16/3	Pointer offset 43
17/1	Pointer offset 44
17/2	Pointer offset 45
17/3	Pointer offset 46
18/1	Pointer offset 47
18/2	Pointer offset 48
18/3	Pointer offset 49
19/1	Pointer offset 50
19/2	Pointer offset 51
19/3	Pointer offset 52
20/1	Pointer offset 53
20/2	Pointer offset 54
20/3	Pointer offset 55
21/1	Pointer offset 56
21/2	Pointer offset 57
21/3	Pointer offset 58
22/1	Pointer offset 59
22/2	Spare
22/3	Spare
23/2	Spare
23/3	Spare
23/2	Spare
24/3	Spare
24/2	Spare
24/3	Spare
25/1	Spare
25/2	Checksum (high byte)
25/3	Checksum (low byte)

5.11 Waveform Capture Commands (3 14 n)

<u>N</u>	<u>Definition</u>
0	Define waveform capture settings
1	Show waveform capture settings
2	Start waveform data accumulation
3	Stop waveform data accumulation
4	Report waveform record data headers
5	Fetch first block of a record
6	Fetch next block of a record
7	Retransmit last block of a record
8	Fetch Acquisition Status

5.11.1 Define Waveform Capture Settings (3 14 0)

Note the trigger sources are logically OR'ed together.

Example: if 3/1 is Hex 07; trigger on 50N-1 or 50N-2 or 50N-3 pickup. The capture is 8 cycles of waveform with 32 samples per cycle. We then have 7 inputs each of 8 cycles capture. The inputs are Ia, Ib, Ic, In, VA, Vb, and Vc . The data is sent from thr DPU in quarter cycle records, that is 32/4 samples per analog variable.

<u>Data Byte</u>	<u>Definition</u>
1/1	Most significant high byte of password
1/2	Most significant low byte of password
1/3	Least significant high byte of password
2/1	Least significant low byte of password
2/2	Spare
2/3	Command + Subcommand = 0xe0
3/1	Trigger source (byte 1)
	Bit 0: 50N-1
	Bit 1: 50N-2
	Bit 2: 50N-3

		Bit 3: 51N
		Bit 4: 50P-1
		Bit 5: 50P-2
		Bit 6: 50P-3
		Bit 7: 51P
3/2	Trigger source (byte 2)	Bit 0: 67P (DPU2000 and DPU2000R)
		Bit 1: 67N (DPU2000 and DPU2000R)
		Bit 2: 46
		Bit 3: 27
		Bit 4: 59 (DPU2000 and DPU2000R)
		Bit 5: 79
		Bit 6: 81S (DPU2000 and DPU2000R)
		Bit 7: 81R (DPU2000 and DPU2000R)
3/3	Trigger source :reserved (byte 3)	Bit 0: Trip issued signal
		Bit 1: Breaker open
		Bit 2: External (WCI)
		Bit 5: 59G
		Bit 6 : 32P (DPU2000 and DPU2000R)
		Bit 7 : 32N (DPU2000 and DPU2000R)
4/1	Trigger source:reserved (byte 4)	
4/2	Trigger position(qtr cycle):	0 to 255 (for 64 qtr cycle record)
		0 to 128 (for 32 qtr cycle records)
		0 to 64 (for 16 qtr cycle records)
		0 to 32 (for 8 qtr cycle records)
4/3	Mode/Record Size	bit 0,1: 00 = 8 rec of 8 qtr cycle record
		01 = 4 rec of 16 qtr cycle records
		10 = 2 rec of 32 qtr cycle records
		11 = 1 rec of 64 qtr cycle records
		bit 6 : Single Shot Mode (0=off, 1=on)
		bit 7 : Append Record Mode (0=off, 1=on)
5/1	Spare	
5/2	Checksum (high byte)	
5/3	Checksum (low byte)	

5.11.2 Report Waveform Capture Settings (3 14 1)

<u>Data Byte</u>	<u>Definition</u>
1/1	Relay Status (see command 3 4 1, msg 1/1)
1/2	Command + Subcommand = 0xe1
1/3	Total Number of Messages = 9
2/1 - 6/3	Unit ID Name (15 characters)
7/1	Trigger source (byte 1)
	Bit 0: 50N-1
	Bit 1: 50N-2
	Bit 2: 50N-3
	Bit 3: 51N
	Bit 4: 50P-1
	Bit 5: 50P-2
	Bit 6: 50P-3
	Bit 7: 51P
7/2	Trigger source (byte 2)
	Bit 0: 67P (DPU2000 and DPU2000R)
	Bit 1: 67N (DPU2000 and DPU2000R)
	Bit 2: 46
	Bit 3: 27
	Bit 4: 59 (DPU2000 and DPU2000R)

		Bit 5: 79
		Bit 6: 81S (DPU2000 and DPU2000R)
		Bit 7: 81R (DPU2000 and DPU2000R)
7/3	Trigger source (byte 3)	
		Bit 0: Trip issued signal
		Bit 1: Breaker open
		Bit 2: External (WCI)
		Bit 5: 59G
		Bit 6 : 32P (DPU2000 and DPU2000R)
		Bit 7 : 32N (DPU2000 and DPU2000R)
8/1	Trigger source (byte 4)	
8/2	Trigger position	
8/3	Mode/Record Size	
		bit 0,1: 00 = 8 rec of 8 qtr cycle record
		01 = 4 rec of 16 qtr cycle records
		10 = 2 rec of 32 qtr cycle records
		11 = 1 rec of 64 qtr cycle records
		bit 6 : Single Shot Mode (0=off, 1=on)
		bit 7 : Append Record Mode (0=off, 1=on)
9/1	Spare	
9/2	Checksum (high byte)	
9/3	Checksum (low byte)	

5.11.3 Arm Waveform Data Accumulation (3 14 2)

Start Waveform data collection.

5.11.4 Disarm Waveform Data Accumulation (3 14 3)

Stop Waveform data collection.

5.11.5 Report Waveform Record Data Headers (3 14 4)

<u>Msg Byte</u>	<u>Definition</u>
1/1	Relay Status (see command 3 4 1, msg 1/1)
1/2	Command + Subcommand = 0xe4
1/3	Total Number of Messages = 38
2/1 - 6/3	Unit ID Name (15 characters)
7/1	Record 0: Trigger position
7/2	Record 0: Year
7/3	Record 0: Month
8/1	Record 0: Date
8/2	Record 0: Hours or Most significant high byte millisec time since midnight
8/3	Record 0: Minutes or Most significant low byte millisec time since midnight
9/1	Record 0: Seconds or Least significant high byte millisec time since midnight
9/2	Record 0: Hundredths of seconds or Least significant low byte millisec time since midnight, see note in command 3 5 8.
9/3	Record 0: Voltage Scale High byte
10/1	Record 0: Voltage Scale Low byte
10/2	Record 0: Mode/Record Size
	bit 0,1 :00 = 8 rec of 8 qtr cycle record
	01 = 4 rec of 16 qtr cycle records
	10 = 2 rec of 32 qtr cycle records
	11 = 1 rec of 64 qtr cycle records
	bit 6 : Single Shot Mode (0=off, 1=on)
	bit 7 : Append Record Mode (0=off, 1=on)
10/3	Record 0: Spare
11/1 - 14/3	Record 1 (same as record 0)
15/1 - 18/3	Record 2 (")

19/1 - 22/3	Record 3 (")
23/1 - 26/3	Record 4 (")
27/1 - 30/3	Record 5 (")
31/1 - 34/3	Record 6 (")
35/1 - 38/3	Record 7 (")

5.11.6 Fetch First Block of a Record (3 14 5)

Bit Position:	0	1	2	3	4	5	6	7	8	9	10	11	12	13	14	15
DPU2000:	IN3	IN4	IN9	IN2	IN10	43A	52B	52A	IN1	IN11	IN8	IN7	IN6	IN5	IN13	IN12
DPU2000R:	IN3	IN4	FB1	IN2	FB2	FB3	FB4	FB5	IN1	FB6	IN8	IN7	IN6	IN5	FB7	FB8
DPU1500R:	IN3	IN4	N/A	IN2	N/A	N/A	N/A	N/A	IN1	N/A	IN6	N/A	N/A	IN5	N/A	N/A

Figure 13 - Physical Input Mapping

Data Byte

<u>Data Byte</u>	<u>Definition</u>
1/1	Record number (0 to 7)
1/2	Record number(Duplicate)
1/3	Record number(Triplicate)

Msg Byte

<u>Msg Byte</u>	<u>Definition</u>
1/1	Relay status (see command 3 4 1, msg 1/1)
1/2	Command + Subcommand = 0xe5
1/3	Total Number of Messages = 34
2/1	Record number
2/2	Block number
2/3	Sample 0: Ia (high byte)
3/1	Sample 0: Ia (low byte)
3/2	Sample 0: Ib (high byte)
3/3	Sample 0: Ib (low byte)
4/1	Sample 0: Ic (high byte)
4/2	Sample 0: Ic (low byte)
4/3	Sample 0: In (high byte)
5/1	Sample 0: In (low byte)
5/2	Sample 0: Va (high byte)
5/3	Sample 0: Va (low byte)
6/1	Sample 0: Vb (high byte)
6/2	Sample 0: Vb (low byte)
6/3	Sample 0: Vc (high byte)
7/1	Sample 0: Vc (low byte)
7/2 - 11/3	Sample 1 data
12/1 - 16/2	Sample 2 data
16/3 - 21/1	Sample 3 data
21/2 - 25/3	Sample 4 data
26/1 - 30/2	Sample 5 data
30/3 - 35/1	Sample 6 data
35/2 - 39/3	Sample 7 data
40/1	Phase scale (high byte)
40/2	Phase scale (low byte)
40/3	Neutral scale (high byte)
41/1	Neutral scale (low byte)
41/2	Input status (high byte) See Figure 13 - Physical Input Mapping.
41/3	Input status (low byte)
42/1	Output status byte
42/2	Miscellaneous status byte
	Bit 0: Trip
	Bit 1: Breaker failure
	Bit 2 :
	Bit 3 :
	Bit 4 : 32P Fault (DPU2000 and DPU2000R)

	Bit 5 : 32N Fault (DPU2000 and DPU2000R)
	Bit 6 : 32P Pickup (DPU2000 and DPU2000R)
	Bit 7 : 32N Pickup (DPU2000 and DPU2000R)
42/3	Pickup status (high byte)
	Bit 0: 50N-1
	Bit 1: 50N-2
	Bit 2: 50N-3
	Bit 3: 51N
	Bit 4: 50P-1
	Bit 5: 50P-2
	Bit 6: 50P-3
	Bit 7: 51P
43/1	Pickup status (low byte)
	Bit 0: 67P (DPU2000 and DPU2000R)
	Bit 1: 67N (DPU2000 and DPU2000R)
	Bit 2: 46
	Bit 3: 27
	Bit 4: 59 (DPU2000 and DPU2000R)
	Bit 5: 79
	Bit 6: 81S (DPU2000 and DPU2000R)
	Bit 7: 81R (DPU2000 and DPU2000R)
43/2	Fault status (high byte)
	Format same as 42/3
43/3	Fault status (low byte)
	Format same as 43/1

5.11.7 Fetch Next Block of a Record (3 14 6)

Same message format as (3 14 5)

5.11.8 Retransmit Last Block of a Record (3 14 7)

Same message format as (3 14 5)

5.11.9 Fetch Acquisition Status (3 14 8)

<u>Msg Byte</u>	<u>Definition</u>
1/1	Relay status (see command 3 4 1, msg 1/1)
1/2	Command + Subcommand = 0xe8
1/3	Total Number of Messages = 32
2/1	Mode/Record Size
	bit 0,1 :00 = 8 rec of 8 qtr cycle record
	01 = 4 rec of 16 qtr cycle records
	10 = 2 rec of 32 qtr cycle records
	11 = 1 rec of 64 qtr cycle records
	bit 6 : Single Shot Mode (0=off, 1=on)
	bit 7 : Append Record Mode (0=off, 1=on)
2/2	Records Remaining (single shot mode)
2/3	State of Accumulation (0=running,1=stopped)

6 Appendix A – Revision History Detail

The goal of this appendix is to detail the protocol document changes such that this appendix could “stand on its own”. In other words only a copy of the appendix is necessary to understand what changed in the protocol. The protocol changes are sectioned by the version of the box. Each section references this document’s revisions which apply.

6.1 DPU2000R version 5.0, Protocol document revisions 7.0 to 8.0

Cmd	Msg Byte	Old Definition	New Definition
3 0 8	12/3 13/1	<u>Logical Output (byte-bit)</u> 16-4 : no definition 16-3 : no definition 16-2 : no definition 16-1 : no definition 17-7 : no definition 17-6 : no definition 17-5 : no definition 17-4 : no definition 17-3 : no definition 17-2 : no definition 17-1 : no definition 17-0 : no definition Spare Spare	59-3ph 59-3ph* 47 47* 21P-1 21P-1* 21P-2 21P-2* 21P-3 21P-3* 21P-4 21P-4* Logical Output byte 17 Logical Output byte 18
3 1 1	Blk 6, offset 12 Offset 50 Offset 52	Bit 4: no definition Bit 3: no definition Bit 2: no definition Bit 1: no definition Bit 0: no definition Does not exist Does not exist	Bit 4: 59-3p Bit 3: 59-3p* Bit 2: 47 Bit 1: 47* Bit 0: spare Logical Outputs 128 – 159 Bits 24-31: 21P-1/2/3/4 and 21P-1*/2*/3*/4* Logical Outputs 160 – 191 Not defined.
3 4 6		Output Offset Index: 123 – 135 do not exist	123: 59-3 124: 59-3* 125: 47 126: 47* 127: spare 128: 21P-1 129: 21P-1* 130: 21P-2 131: 21P-2* 132: 21P-3 133: 21P-3* 134: 21P-4 135: 21P-4*
3 5 12		Operation Message Number: 216 – 232 are missing, 233 – 238 do not exist.	233: 59-3P Alarm 234: 47 Alarm 235: 21P-1 Zone 1 Trip 236: 21P-2 Zone 2 Trip 237: 21P-3 Zone 3 Trip 238: 21P-4 Zone 4 Trip
3 9 3		Output byte 6: Bit 5: LO1 Bit 4: LO2	Output byte 6: Bit 5: 59-3P* Bit 4: 47*

DPU 2000R UCA TECHNICAL GUIDE

Cmd	Msg Byte	Old Definition	New Definition
		Bit 3: LO3 Bit 2: LO4 Bit 1: LO5 Bit 0: LO6 Output byte 7: Bit 7: LO7 Bit 6: LO8 Bit 5: TR_ON Bit 4: TR_OFF Bit 3: TR_TAG.	Bit 3: 21P-1* Bit 2: 21P-2* Bit 1: 21P-3* Bit 0: 21P-4* Output byte 7: Bits 7 – 3 are not used; undefined.
3 11 6		Output Offset Index: 123 – 135 do not exist	123: 59-3 124: 59-3* 125: 47 126: 47* 127: spare 128: 21P-1 129: 21P-1* 130: 21P-2 131: 21P-2* 132: 21P-3 133: 21P-3* 134: 21P-4 135: 21P-4*

