



Main catalog

Industrial Automation & Motion PLCs, HMIs, Software, Drives, Servo Drives, Motion Controllers

Power and productivity
for a better world™



Industrial Automation & Motion

PLCs, HMIs, Software, Drives, Servo Drives, Motion Controllers

AC500 products family	1
Automation Builder - Integrated engineering suite	2
AC500-eCo - Entry level PLC solutions	3
AC500 - High performance modular PLC	4
AC500-XC - PLC operating in eXtreme Conditions	5
AC500-S - Functional Safety PLC	6
CP600 and CP400 series - HMI and control panels	7
DigiVis 500 - Supervision software	8
Low voltage drives	9
Motion control	10
Application descriptions and additional information	11
Index	12

AC500 products family

Overview

1

ABB offers a comprehensive range of scalable PLCs and robust HMI control panels as well as high-availability solutions.

Since its launch in 2006, the AC500 PLC platform has achieved significant industry recognition for delivering high performance, quality and reliability. ABB delivers scalable, flexible and efficient ranges of automation components to fulfill all conceivable automation applications.



Example of connectivity options for AC500





AC500

ABB's powerful flagship PLC offering a wide range of performance levels and scalability within a single, simple concept where most competitors require multiple product ranges to deliver similar functionality. Web server integrated and IEC 60870-5-104 remote control protocol for all Ethernet versions.



AC500-eCo

Meets the cost-effective demands of the small PLC market whilst offering total inter-operability with the core AC500 range. Up to 10 I/O modules connected to the CPU, fast counter onboard CPU up to 50 kHz. Web server, FTP server and Modbus-TCP for all Ethernet versions. A Pulse Train Output module is available for multi axis positioning.



AC500-S

A PLC based modular automation solution that makes it easier than before to mix and match standard and safety I/O modules to expertly meet your safety requirements in all functional safety applications. "Extreme conditions" version is also offered.



AC500-XC

"Extreme conditions" modules with extended operating temperature, immunity to vibration and hazardous gases, use at high altitudes, in humid conditions, etc. It replaces advantageously expensive cabinets by its built-in protection against dirt, water, gases, dust.



Drives & Motion control

Our motion control products and low voltage AC drives include a choice of real-time Ethernet and high-performance multi-axis motion control. A broad selection of capabilities includes communications options, drive-based functional safety features and programming tools to adapt to a wide range of applications.



Control panels

Our control panels offer a wide range of touchscreen graphical displays from 3.5" up to 15". They are provided with a user friendly configuration software that enables tailor made customized HMI solutions. Rich sets of graphical symbols and the relevant drivers for ABB automation products are provided. Control panels for visualization of AC500 webserver applications are available as well. ABB Robotics IRC5 controller driver included in Panel Builder 600 for direct connection.



DigiVis 500

DigiVis 500 software is a simple and easily accessible solution in the development of supervision applications. It offers all the functions that are essential to a secure environment, its functional reliability and dual-display mode will simplify all your supervision operations, keeping interruptions to a minimum.



Engineering Productivity

Automation Builder integrates the Engineering and Maintenance for PLC, Drives, Motion, HMI and Robotics. Automation Builder complies with the IEC 61131-3 standard offering all 5 IEC programming languages for PLC and Drive configuration. In addition, Automation Builder includes continuous function chart, C/C++, extensive function block libraries, as well as powerful embedded simulation and visualization features. Automation Builder supports a number of languages (English, German, French, Chinese, Spanish) and comes with new libraries, FTP functions, SMTP, SNMP, smart diagnostics and debugging capabilities. Download Automation Builder from www.abb.com/automationbuilder

AC500 products family Automation Builder

1 Engineering Productivity for Machine Builders and System Integrators

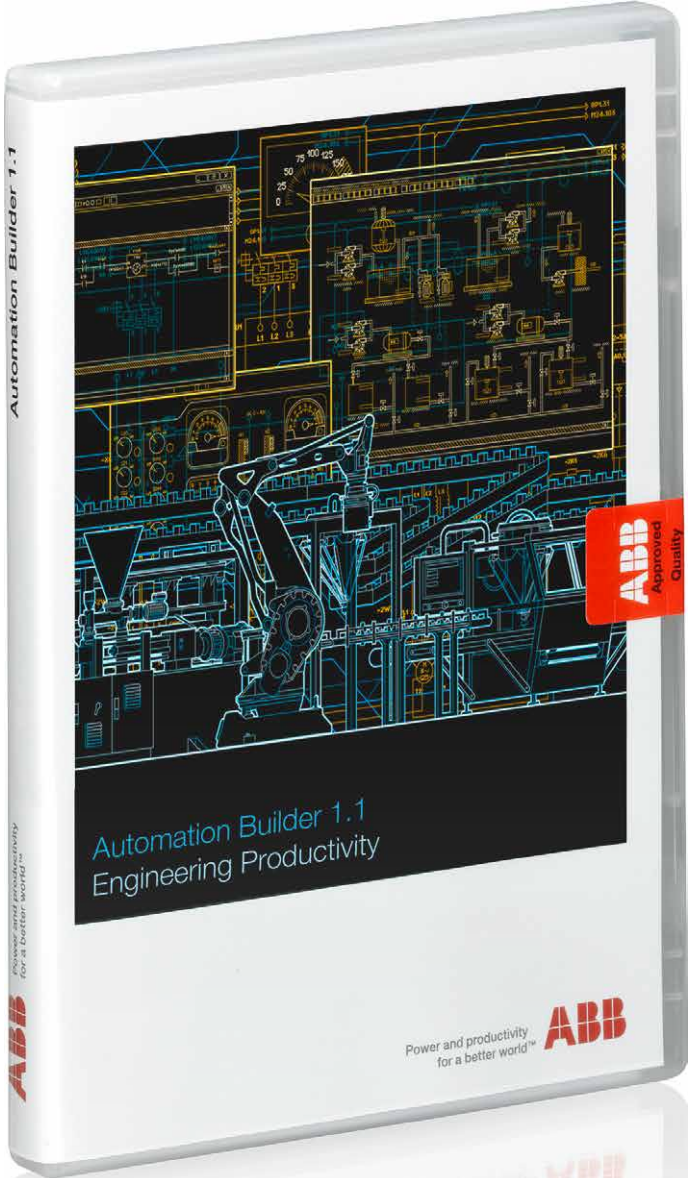

Discover engineering productivity in engineering your discrete automation solutions.

Automation Builder is ABB's integrated programming, maintenance and simulation environment for PLCs, safety, robots, motion, drives and control panels.

Automation Builder combines the proven ABB tools Robot-Studio, Drive Manager, Mint WorkBench, Panel Builder and succeeds Control Builder Plus.

Minimize your efforts for managing your project code and data with Automation Builder.

Improve your productivity through seamless engineering – common data storage, single project archive, time saving library blocks for device integration, and a common software installer.

Reduce engineering effort and maintenance cost using easy to use libraries for applications in wind, water, solar, drives, motion, robotics and safety.

Benefit from the simplicity of IEC 61131-3, PLCopen, C/ C++, RAPID and MINT programming languages.

Speed up your project by the powerful ECAD and MS EXCEL® interfaces capabilities of Automation Builder.

Reduce downtime by simplified diagnostics and maintenance.

Automation Builder is this single software suite for you to configure and program various ABB controller families in a single project.

Secure and restore your applications in a consistent joint backup.

Download Automation Builder from www.abb.com/automationbuilder.

Get familiar with Automation Builder using its 30 days test license.

When your needs are clear, use the free Automation Builder Basic or purchase Automation Builder Standard or Premium.

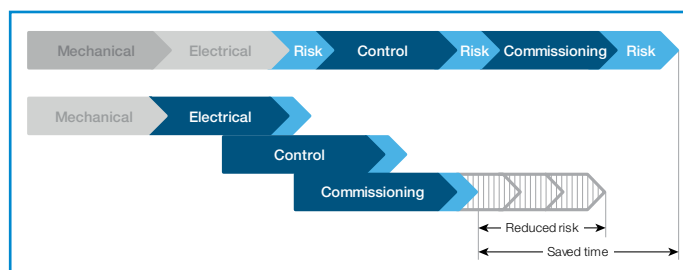

Gain 30% productivity with Automation Builder

Product license options

	Automation Builder Basic	Automation Builder Standard	Automation Builder Premium
Free	■		
AC500-eCo	■	■	■
AC500 with local I/O & network (1)	■	■	■
AC500 with fieldbus (2)		■	■
AC500-S Safety		□	□
Drive Manager		■	■
Drive application programming (3)	□	□	□
Motion programming	■ (4)	■	■
Panel Builder 600	□	■	■
Integrated engineering (5)		■	■
Advanced features (6)			■

(1) TCP protocols, Modbus, IEC60508-5 101, CS31
 (2) PROFIBUS, PROFINET, EtherCAT, CAN
 (3) Drive composer pro license needs to be purchased
 (4) No Fieldbus connectivity in Automation Builder Basic
 (5) PLC, Safety, Panel, Drive, Motion, Robotics
 (6) C/C++, EPLAN data exchange, CSV interface extensions, project compare

AC500 products family

At a glance...

1

The AC500 Programmable Logic Controllers offers the latest technology enhancements with greater performance in a scalable package.

Standard industrial communications fieldbus, networks and protocols supported by the 'One Platform' solution enable the AC500 to be a very capable automation solution in demanding

environment. The flexible scalable range of superior performance CPUs enables complete control of your application whenever and wherever you need it.

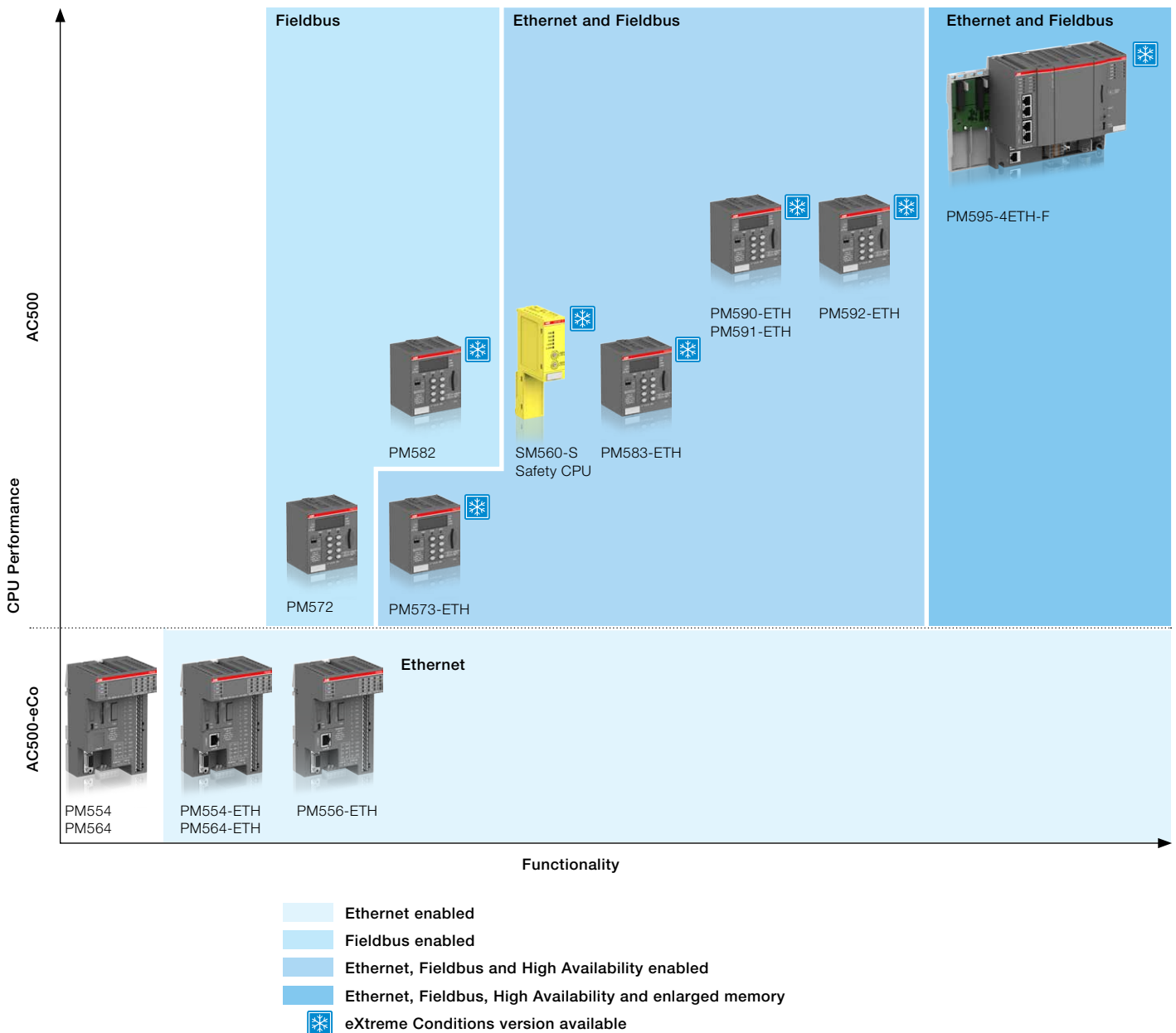

AC500 products family

At a glance...

	AC500-eCo	AC500	AC500-XC	AC500-S (2)	AC500-S-XC (2)
System Configuration and Application programming					
Automation Builder (common programming tool)	■	■	■	■	■
Application Features					
Extended temperature range			■		■
Functional safety				■	■
Support of simple motion with FM562 module (1)	■	■	■	■	■
Support of coordinated motion (1)		■	■	■	■
Support of High Availability (HA)		■	■		
CPU Features					
Performance (time per binary instruction)	0.08 µs	0.0006...0.06 µs	0.0006...0.06 µs	0.05 µs	0.05 µs
Program memory	128...512 kB	128...16 MB	128...16 MB	1024 kB	1024 kB
User data memory	14...130 kB	128...16 MB	128...16 MB	1024 kB	1024 kB
Remnent data (= saved)	2 kB	12...3 MB	12...3 MB	120 kB	120 kB
Serial communication					
RS232		■	■	■	■
RS485	■	■	■	■	■
Isolated interface		■	■	■	■
Ethernet					
DHCP, FTP server, Web server	■	■	■	■	■
Programming	■	■	■	■	■
Modbus-TCP	■	■	■	■	■
IEC 60870-5-104 remote control protocol		■	■	■	■
SNTP (Simple Network Time Protocol)		■	■	■	■
SMTP (Simple Mail Transfer Protocol)		■	■	■	■
Downloadable protocol		■	■		
Capability to connect Fieldbus Modules		■	■	■	■
I/Os integrated on CPU	■				
I/O Modules Features					
	S500-eCo	S500	S500-XC	S500-S (2)	S500-S-XC (2)
Analog modules					
Configurable		■	■		
Dedicated	■			□	□
Digital modules					
Configurable	□	■	■		
Dedicated	■	■	■	□	□
Transistor outputs short circuit protected		■	■	■	■
Diagnosis for outputs		■	■	■	■
Extension with S500-eCo and S500(-XC) I/O modules	■	■	■	■ (2)	■ (2)

■ fully
□ partly

(1) Requires Library PS552-MC-E.

(2) AC500-S and AC500-S-XC are extension CPU modules. They require an AC500 or AC500-XC CPU to operate. The latter support all communication interfaces.

AC500 products family

AC500-eCo

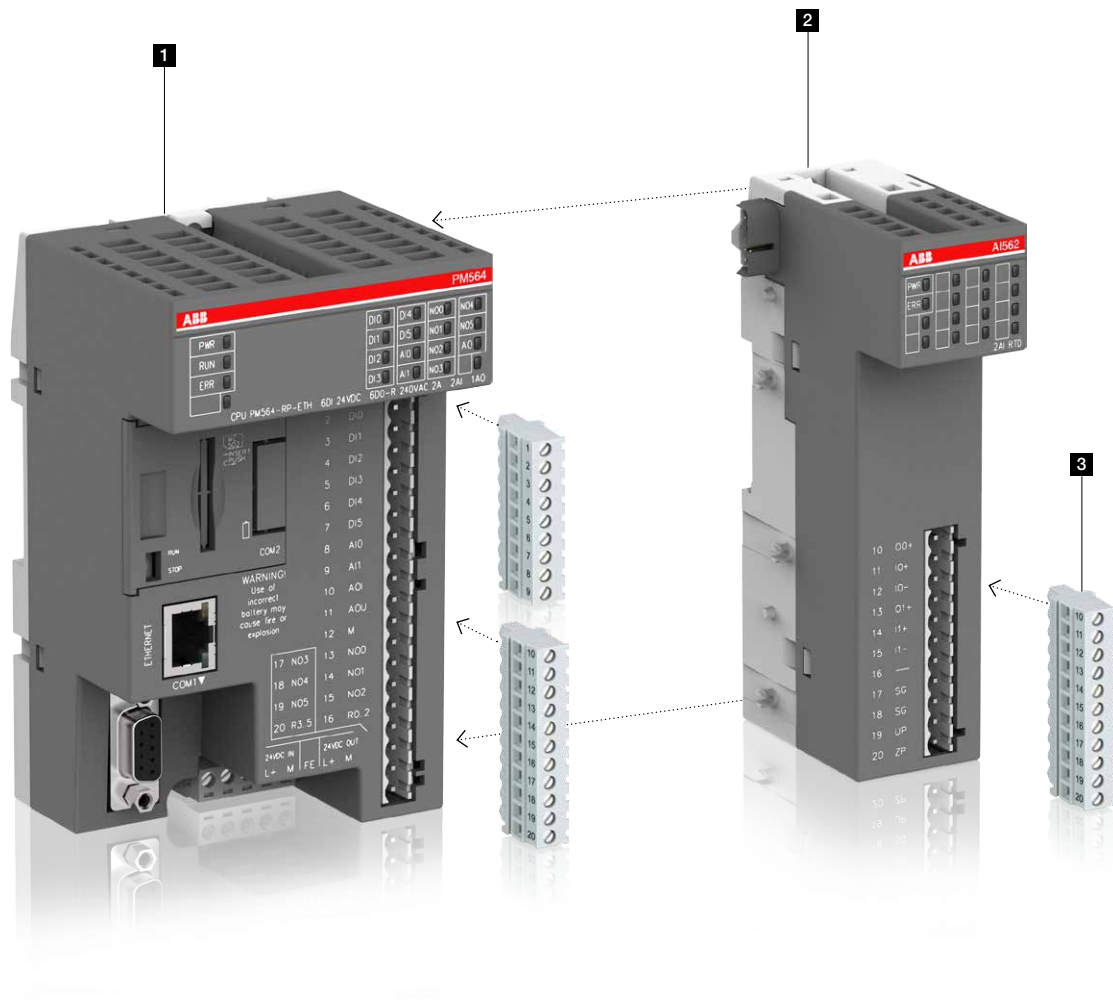

1 AC500-eCo Central Processing Unit (CPU)

- Different memory options
- Integrated communication option.

2 S500-eCo I/O Modules

- Up to 10 expansions
- Decentralized extension available.

3 Terminal blocks

- Three types of pluggable terminal blocks available.

AC500 products family

AC500 and AC500-XC

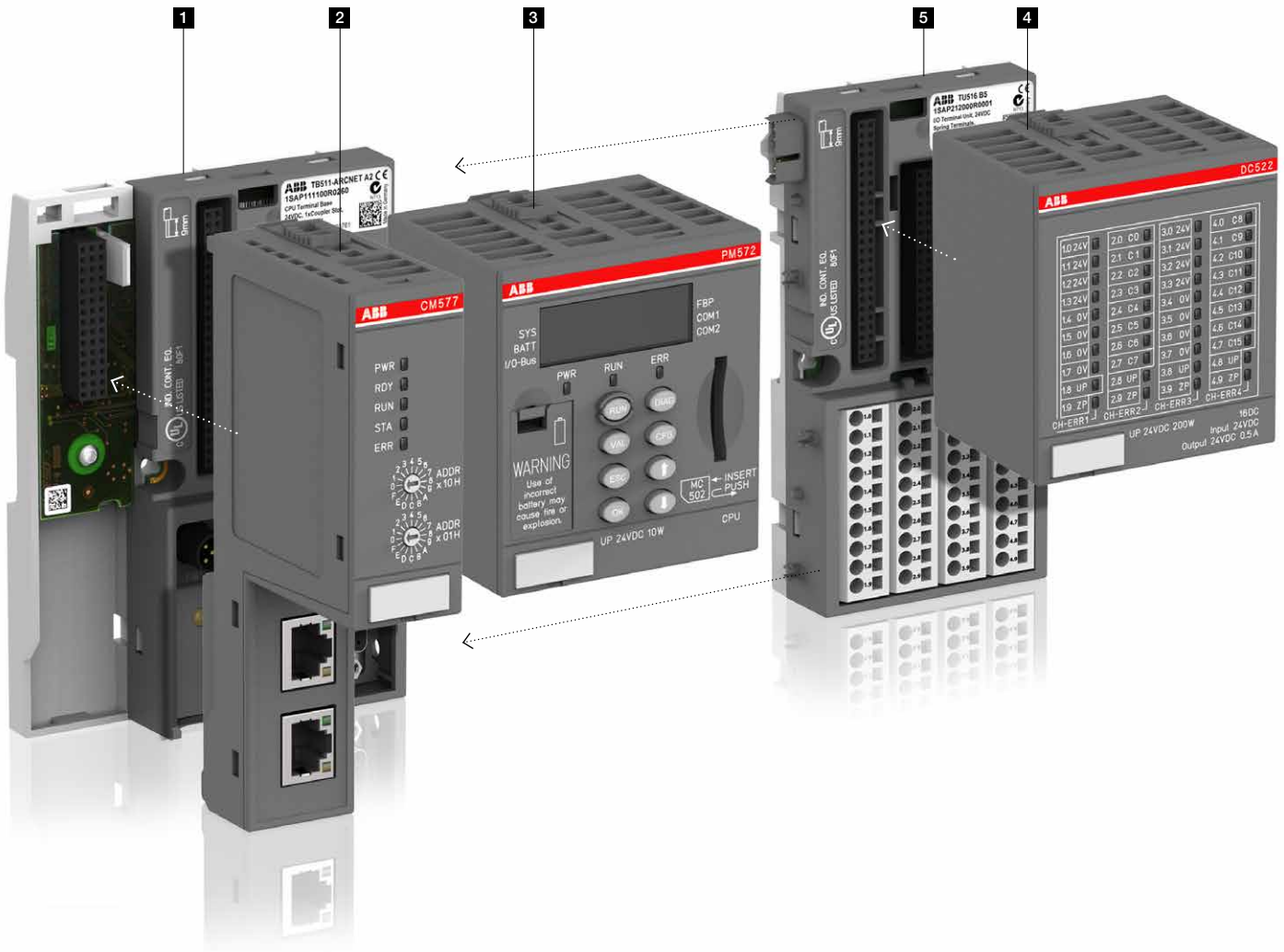

1 Terminal Base

- Same for all AC500 CPU types
- For 1, 2 or 4 communication modules
- With serial interfaces.

2 Communication Modules

- For PROFIBUS DP®, Ethernet, Modbus TCP, EtherCAT®
- CANopen® or PROFINET® IO
- Up to 4 pluggable.

3 AC500 Central Processing Unit (CPU)

- Different performance, memory, network, operating conditions options
- Integrated communication.

4 S500 I/O Modules

- Up to 10 expansions
- Decentralized extension available.

5 Terminal units

- Up to 10 terminal units
- Decentralized extension available.

AC500 products family

AC500-eCo system characteristics

1

AC500-eCo CPUs can be locally expanded with up to 10 I/O modules.
 New AC500-eCo CPUs for use with pluggable terminal blocks available.

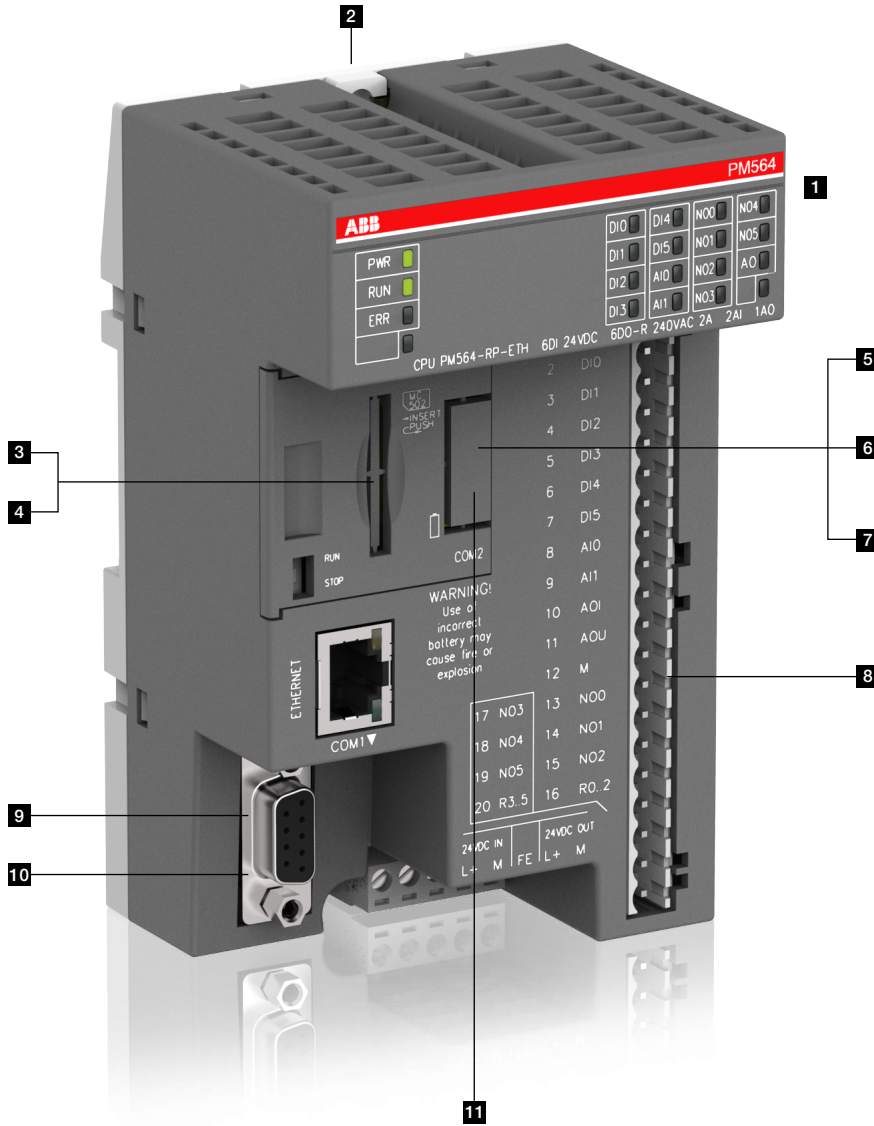

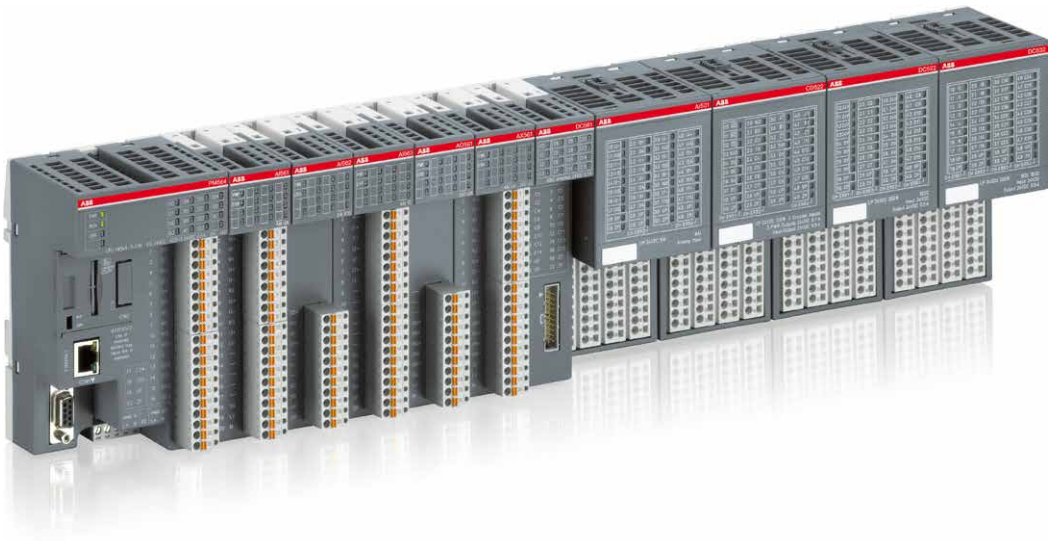

1 AC500-eCo CPUs can be locally expanded with up to 10 I/O modules (Standard S500 and S500-eCo I/O modules can be mixed).



2 Wall mounting



3 SD-card adapter



4 SD-card



5 Adapter with realtime clock

6 Adapter with COM2 & realtime clock



7 Adapter with COM2



8 Terminal blocks



9 RS485 isolator for COM1



10 COM1 USB

11 COM2 USB programming cable



AC500-eCo Starter kit. More information page 165.

AC500 products family

AC500 system characteristics

1

AC500, superior local extension capabilities for I/O communication and best-in-class CPU functionality and industry leading performance.



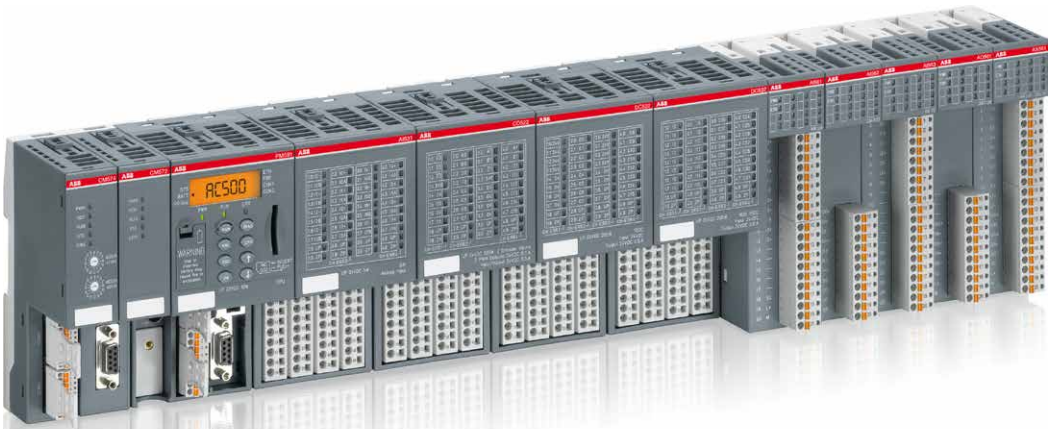

1 AC500 CPUs can be locally expanded with up to 10 I/O modules (Standard S500 and S500-eCo I/O modules can be mixed).



2 Terminal base



3 Communication module
Up to 4 modules in numerous combinations to communicate with nearly everything



4 CPU module



5 S500 Terminal unit



6 S500 I/O module



7 S500-eCo I/O module



8 SD-card



9 Battery



10 Pluggable marker holder for I/O modules with template (Word format)

AC500 products family

AC500 New PM595 Controller system characteristics

1

The AC500 New PM595 Controller is the Flagship of the AC500 platform. According our design parameters the AC500 PM595 Controller is scalable, flexible and efficient as the whole AC500 range.

With the new AC500 CPU PM595 ABB is launching a new core for machinery control applications. The built in high performing processor surrounded with a large memory offers the needed easiness, security and reliability to adapt the automation solution to new upcoming challenges.

A variety of connectivity capabilities, integrated safety and utilizability even under rough environment provide valuable benefits to machine builders for their automation tasks.

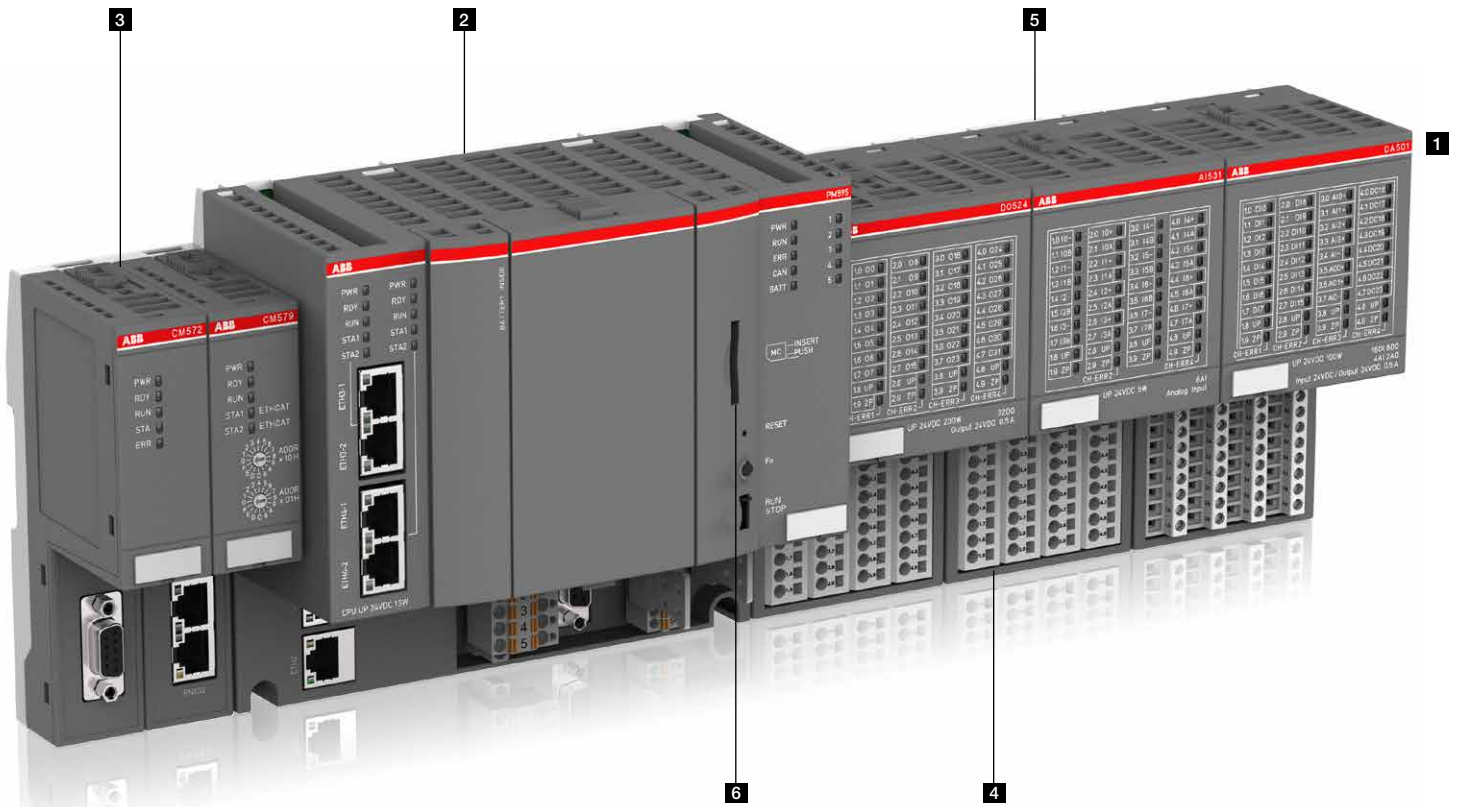

1 AC500 CPUs can be locally expanded with up to 10 I/O modules (Standard S500 and S500-eCo I/O modules can be mixed).

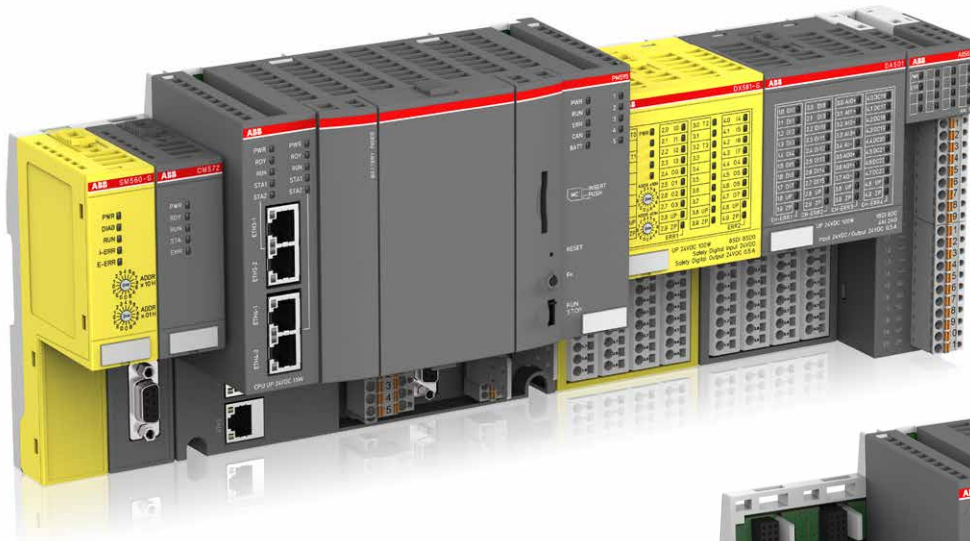

2 CPU with integrated connectivity and terminal base



3 Communication module
Up to 2 modules in numerous combinations to communicate with nearly everything



4 S500 Terminal unit



5 S500 I/O module



5 S500-eCo I/O module



6 SD-card



7 Battery



8 Pluggable marker holder for I/O modules with template (Word format)

AC500 products family

Functional Safety

1

AC500-S Safety PLC is the answer for complex machine safety applications that need the highest level of reliability, efficiency and flexibility.

Hence this safety PLC is aimed at protecting people, machines or processes, environment and investment. An ideal choice of safety PLC that is well suited for wind turbine, crane, hoist and robot applications.





1 Safety CPU



2 S500 Safety I/O module



3 Safety terminal unit

More integration and easier programming

Featuring a consistent look and feel across the entire range, the AC500 is the PLC of choice for applications where uncompromising flexibility, integration and communication are a must. With Automation Builder, you easily integrate your safety application with your ABB PLC, Safety, Drives, Motion, HMI and Robotics. Automation Builder is simple to use through the integrated standard languages like IEC 61131-3, letting you get up and running in no time at all. And not only that: Clear configuration of the overall system with one single tool ensures optimal transparency.

With the AC500-S Safety PLC, the latest addition to the AC500 family, ABB takes the stress out of managing even the most complex safety applications. Support for safety-relevant calculations such as COS, SIN, TAN, ASIN, ACOS and LOG makes the AC500-S ideal for applications in fields like crane engineering, wind power generation, robotics and hoist technology. Plus it gives you greater flexibility and simplicity thanks to safety programming under Structured Text (ST) as well as full support for Function Block Diagram (FBD) and Ladder Diagram (LD). Also available in extreme conditions version.

AC500 products family

Extreme conditions

1

PLC AC500-XC for extreme conditions to be used indoor and outdoor. Ruggedized variants of AC500 for those fighting with the elements.

Hence this PLC AC500-XC is aimed to be reliable, functional and operational even under rough environmental conditions.





1 Terminal base



2 Extreme conditions communication module



3 Extreme conditions CPU



4 Extreme conditions CPU with integrated connectivity and terminal base



5 Extreme conditions S500 terminal unit



6 Extreme conditions S500 I/O module



Operating in wet environment
 – Increased resistance to 100 % humidity with condensation.



Extended operating temperature
 – -40 °C up to +70 °C operating temperature.



Use at high altitudes
 – Operating altitude up to 4000 m above sea level or air pressure up to 620 hPa.



Extended immunity to corrosive gases and salt mist
 – G3, 3C2 immunity
 – Salt mist EN 60068-2-52 / EN 60068-2-11.



Extended immunity to vibration
 – 4 g root mean square random vibration up to 500 Hz
 – 2 g sinusoidal vibration up to 500 Hz.



Extended EMC requirements
 – EN 61000-4-5 surge immunity test
 – EN 61000-4-4 transient / burst immunity test.

AC500 products family

AC500 libraries

1

The AC500 libraries increase stability, while reducing warranty and service efforts. A good investment for System Integrators and end-users. These library packages contain easy to use examples enabling with minimal programming effort to realize also complex and demanding applications quickly.

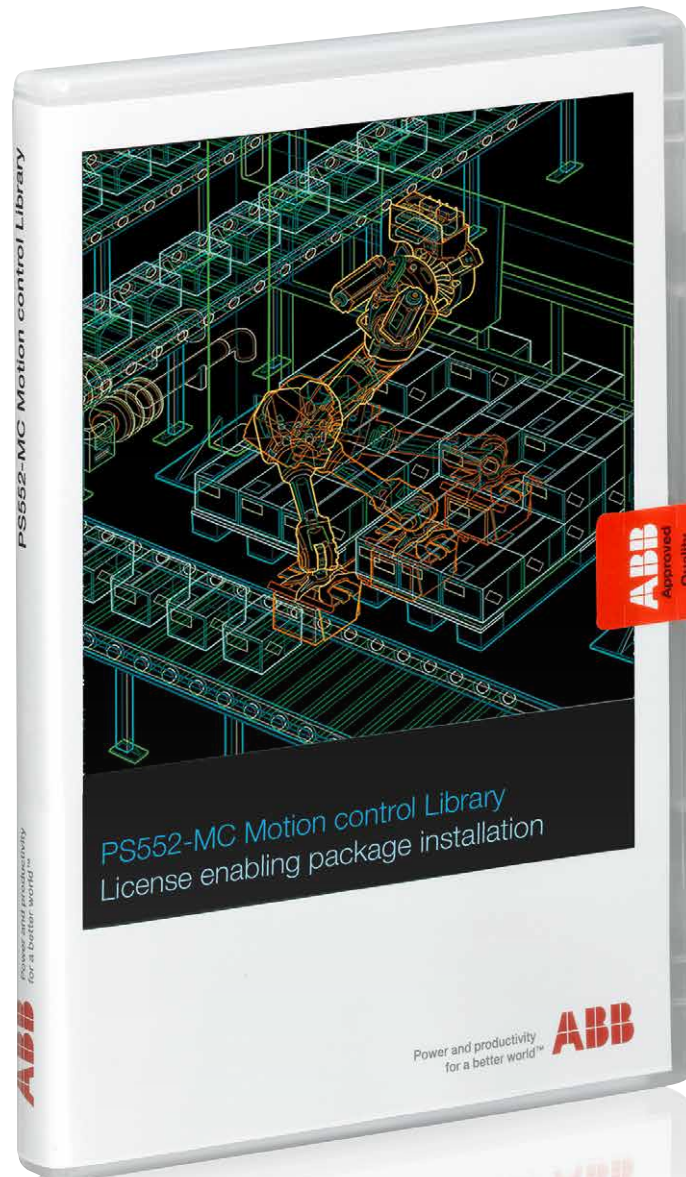

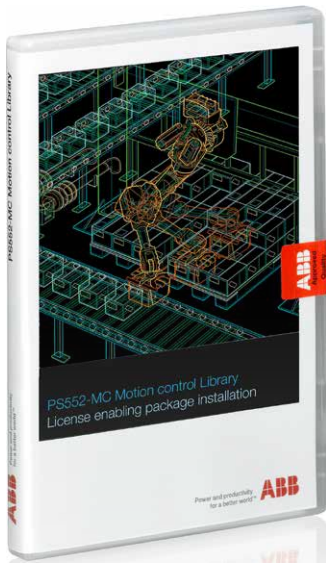

1 Motion control library

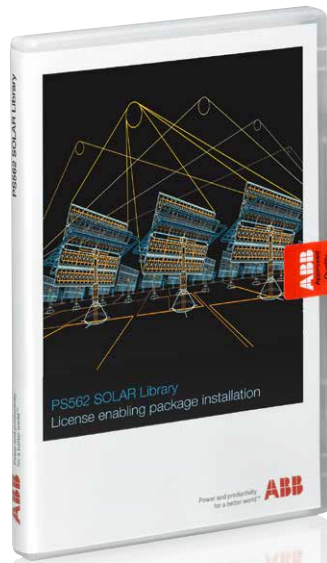

2 Solar library

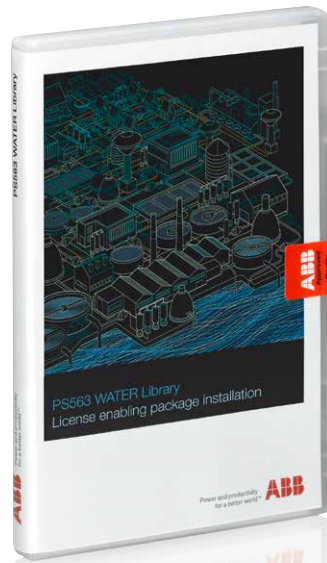

3 Water library

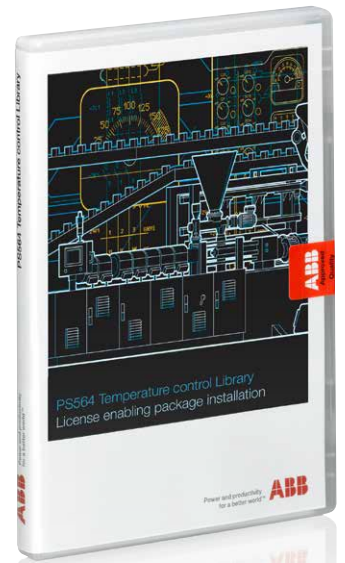

4 Temperature control library

AC500 libraries especially focus on easy integration of drives, HMI and supervisory systems, enabling your automation solution to be built and commissioned quickly. AC500 solution libraries by ABB are maintained to ensure that your programs can also be used with less risk.

Motion control library

Library package for decentral, central and coordinated motion following PLCopen® standard.

Solar library

Library package for solar trackers to increase energy efficiency, fast commissioning, excellent positioning accuracy.

Water library

Library package with functions for energy efficiency and fast commissioning of water applications for example pumping stations and remote communications.

Drives integration library

Library package for fast integration of ABB ACS drives with different field busses. Included free-of-charge in the Automation Builder suite.

Temperature control library

Library package for advanced temperature control in demanding applications, for example in extrusion.

AC500 products family CP600 series

1

ABB control panels can be distinguished from their competitors by their easy yet comprehensive functionality, making clear and easy to understand tailor made operational information for production plants and machines available at a single touch. CP600 control panels make machine operation efficient, predictable and user-friendly.



Build effective graphic interfaces with Panel Builder 600 - efficient representation of your information



Automation Builder
programming station



CP600



AC500
without Webserver

Save engineering time by using Automation Builder for both your PLC and WebVisu



Automation Builder
programming station



AC500
with Webserver



CP600-WEB
with visualization for
AC500 web server

Connectivity with Drives directly without PLC



Automation Builder
programming station

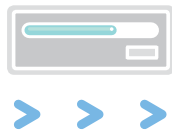

CP600



Drives

Automation products

Supervision solution

1 DigiVis 500 software is a simple and easily accessible solution in the development of supervision applications.

It offers all the functions that are essential to a secure environment, its functional reliability and dual-display mode will simplify all your supervision operations, keeping interruptions to a

minimum. Whether you are an OEM, a machine manufacturer or an integrator, DigiVis 500 will adapt to any application, machine or control room.



Create your applications quickly and easily

The environment and the development functions have been designed to offer greater accessibility and to be exceptionally user friendly. The management structure allows you to place data in a hierarchy and access the different elements of your project efficiently.

Configuring the supervision applications is easy, whether you create your own or choose to customize or use one of the predefined models from the different libraries.

Adaptability

A range of options is available to allow you to choose and adjust the maximum number of operational variables per project. Ranging from 50 to an infinite number of variable (OPC signals), you will surely find a size to fit your application needs.

Save time

DigiVis 500 is easy to connect and put into operation thanks to its interaction with our PLC AC500 solution.

The development functions require no scripting, so you will not waste time with debugging.

What is more, updating your projects on the fly allows you to quickly make any minor changes without rebooting the software.

Manage your projects efficiently

DigiVis 500 software runs on any Windows XP/7 PC platform.

The dual-display mode enhances availability.

The overview offers quick access to all available visualization screens. The "DigiBrowse" option gives you access to all the supervision data outside the software.

Manage your results

Data processing is optimized from archiving and safeguarding to exporting and making practical use of the data.

Modularity

Whatever the size of your system, DigiVis 500 will suit your needs. It will also allow you to manage High Availability systems with our turnkey PLC (CI590) supervision solution.

Reliability and security

The software's reliability and stability ensure a constant flow in the supervision of installations and the recovery of key data, particularly in managing high-availability solutions. The in-built alarm system enables you to ensure the integrity of your installations by customizing the advanced configuration.

The "Security lock" option, which controls access, allows you to configure up to 16 profiles for a maximum of 1 000 individual users.

ABB motion control

Capability without complexity

1

ABB motion control drives offer flexible technologies and high performance motor control to solve a wide variety of applications.



For more than 25 years, MINT motion controls have been solving simple and complex motion tasks in the fields of packaging, electronics assembly and test, simple CNC systems and many more. MINT™ is a high level programming language for simple multi-axis machine control. It combines multitasking efficiency, with event driven responsiveness and a simple plain english language to simplify machine and motion applications. MINT is supported by different platforms, such as intelligent drives, panel-mount analog / stepper, real-time Ethernet motion controllers, and plug-in controllers for drives, providing versatility in tackling a wide variety of applications.

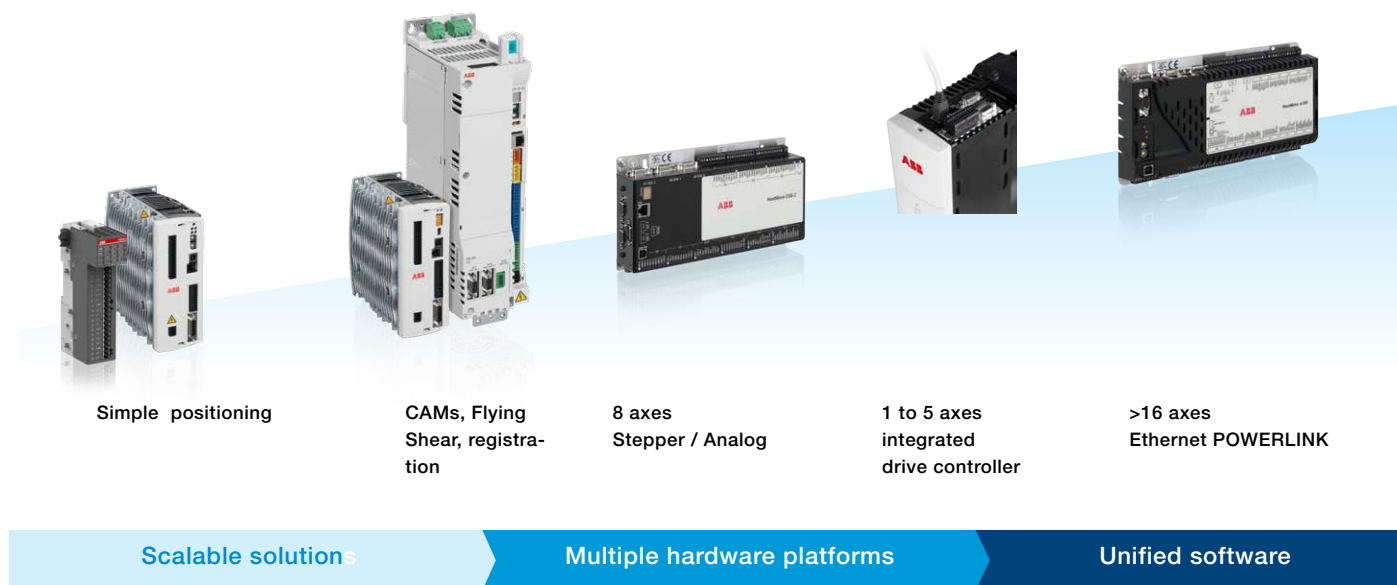

MINT™ programmable motion systems

NextMove motion controllers offer high-level machine programming, multi-axis coordinated motion and a choice of technologies from stepper control, analog control and real-time Ethernet. Our intelligent drives are also programmable in the same easy to use MINT language.

Flexible intelligent drives

MicroFlex e100 and MotiFlex e100 are programmable in MINT Lite and provide solutions to simple motion tasks such as indexing. MINT lite also allows flexible solutions to distributed control from PLCs where the behavior of each axis can be tailored to simplify control schemes.

Motion control library

This library package for decentral, central and coordinated motion enabling fast and standardized engineering, especially together with ABB's motion control ACS Drives. The development of this library according PLC Open Standard offers a future proof investment.

Advanced intelligent drives

MicroFlex e150 supports multi-tasking MINT programming with additional support for software CAMs, flying shears offering a single device solution to applications such as cut-to-length and labelling. ACSM1 high power motion drives feature SPC function block programming and a drive to drive (D2D) link for synchronization of multiple axes,

Multi-axis intelligent drives

A plug-in MINT motion controller option for MotiFlex e100 provides up to five axes of coordinated motion, eliminating the need for an external controller. This high performance solution utilizes Ethernet POWERLINK and reduces cabling and panel space significantly offering a cost advantage.

Intelligent HMI add-on

CP600 control panels offer easy-to-configure drivers for direct connection of motion controller and HMI.

Low Voltage AC Drives

For premium motor control

1

You base your business on cost efficiency and performance. We build advanced drive technology that's capable and compatible with your needs, for today and tomorrow. Our low voltage AC drives are flexible for you to optimize your process control, and reliable for high availability. You also get premium service, responsible solutions and expertise at your disposal, anywhere on the globe.



You base your business on cost efficiency and performance. We build advanced drive technology that's capable and compatible with your needs, for today and tomorrow. Our low voltage AC drives are flexible for you to optimize your process

control, and reliable for high availability. You also get premium service, responsible solutions and expertise at your disposal, anywhere on the globe.



ACS880-01

All-compatible wall-mounted drive with everything built-in.



ACSM1

The flexible workhorse for many high performance applications.



ACS310

Built-in features for pump and fan applications.



ACS580

A wide power range for a broad range of industries.



ACS355

Compact and easy drives to install, set and commission.



ACS850

Flexibility and scalability for machinery applications.

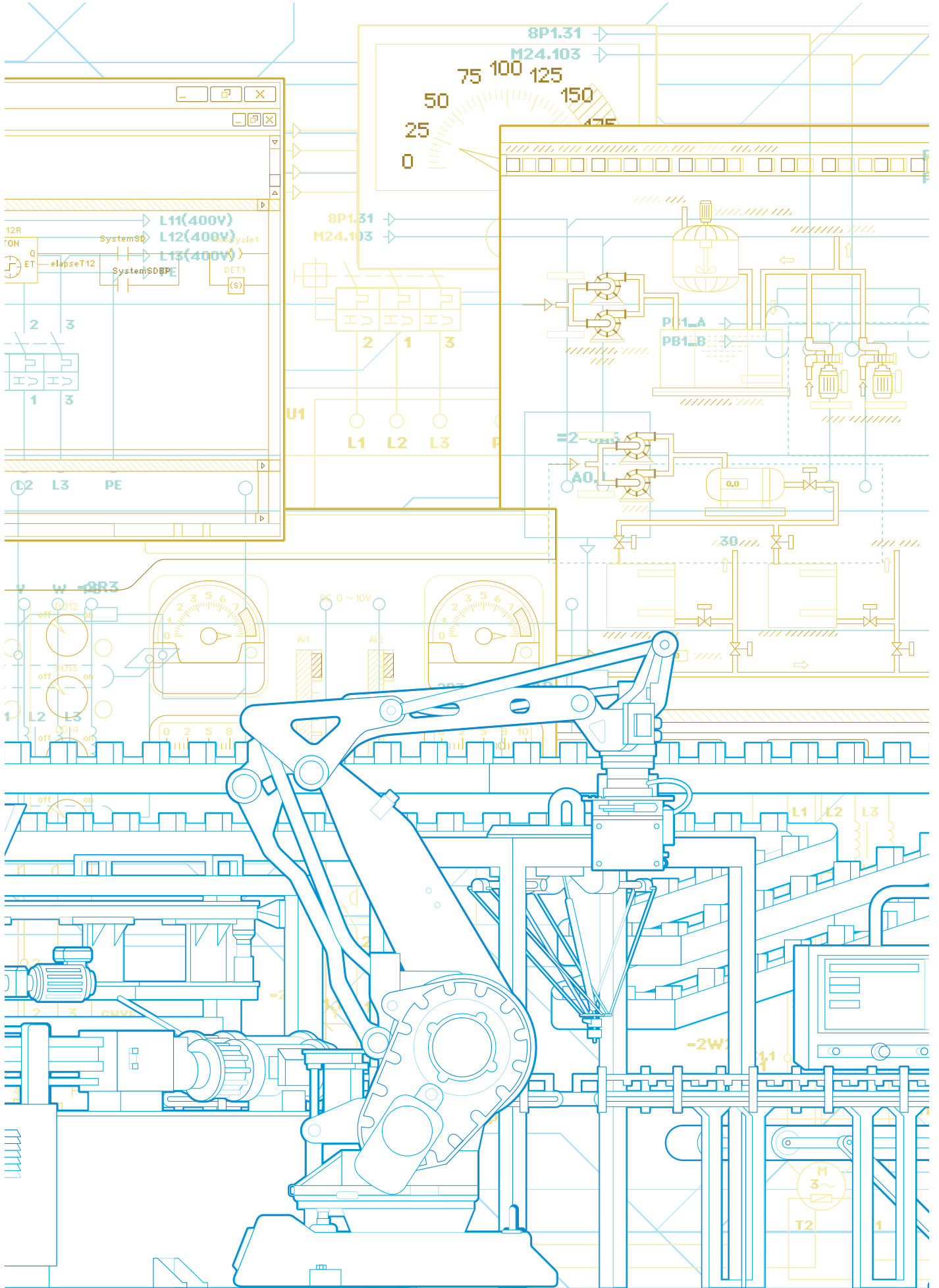

Automation Builder

Integrated engineering suite

Key features	2/32
Integrated engineering suite	2/33
Software features	2/34
Libraries features	2/35

Automation Builder

Key features

2

Engineer your control and safety functions using IEC 61131-3 languages, CFC or C/ C++

Reduce downtime through Automation Builder's powerful debugging and diagnostics. Configure high performance control panel applications

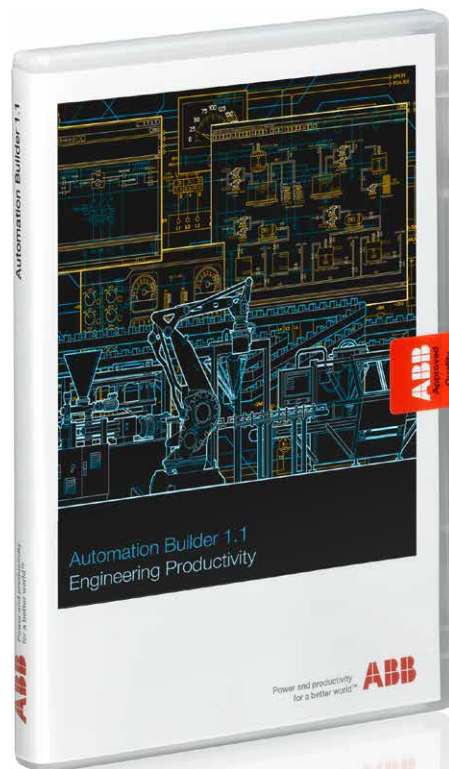

Program and simulate your robots application in Automation Builder's RobotStudio

Seamlessly integrate and optimize your drives and motion configuration

Download Automation Builder from www.abb.com/automationbuilder

Automation Builder

Integrated engineering suite



Automation Builder



Solar library



Water library



Motion control library



Temperature control library

Automation Builder Engineering Suite

- Engineering Productivity and Maintenance for PLCs, safety, robots, motion, drives and control panels.
- Supports IEC61131-3, CFC, C/ C++. Optional: MINT, Rapid for motion and robotics applications.
- Language packs for English, German, Chinese, Spanish, French

For	Description	Type	Order code	Price	Weight (1 pce) kg
AC500 w/o field-bus and safety	Automation Builder Basic (1)	-	-		-
AC500, drives, motion, panel	Automation Builder Standard	DM-TOOL	1SAP193000R0101		0.005
	Automation Builder Premium	DM-PREM	1SAP193005R0101		0.005
	Automation Builder Premium Upgrade (2)	DM-PREM-UPGR	1SAP193004R0101		0.005
	Automation Builder Version Upgrade (3)	DM-TOOL-UPGR	1SAP193001R0101		0.005
	USB Key	DM-KEY	1SAP193600R0001		0.010
	License for runtime visualization package. For installation and visualization of images created with the Automation Builder Engineering Suite (5)	PS541-HMI (4)	1SAP190500R0001		0.300

(1) Free license

(2) Purchase this option to upgrade a Standard version to a Premium version

(3) Purchase this option for upgrading from Control Builder Plus

(4) This package allows granting the license for the software. To install the HMI software, Automation Builder must be purchased separately.

(5) Delivery includes license code and documentation

Libraries

For	Description	Type	Order code	Price	Weight (1 pce) kg
all AC500 CPUs	Solar library (6)	PS562-SOLAR	1SAP195000R0001		0.300
all AC500 CPUs	Water library (6)	PS563-WATER	1SAP195200R0001		0.300
all AC500 CPUs	Motion Control library, Extended (6)	PS552-MC-E	1SAP192100R0002		0.300
all AC500 CPUs	Temperature control library (7)	PS564-TEMPCTRL	1SAP195400R0001		0,010

(6) Delivery on USB stick that includes: library, single license code and documentation.

(7) In preparation; Delivery includes single license code, Software can be downloaded.

Further application libraries and examples:

Please check and download further libraries and examples from: www.abb.com/plc

Use English language setting, then click on "Applications Libraries" or "Applications Examples".

- **Applications Libraries** add further functionality to AC500 PLC's. They are well tested larger library packages with application example(s) and documentation, have limited support and are free of charge.
- **Applications Examples** explain functionality by using e.g. standard Automation Builder libraries and functions in simple examples. They are tested in the described example configuration and functionality only and also come with documentation and are free of charge.

Applications Libraries and Examples help to minimize valuable programming and testing time for specific applications.

Automation Builder

Software features



2

	Automation Builder Basic	Automation Builder Standard	Automation Builder Premium
Description	Basic system engineering for FREE	Integrated engineering of complex systems	Productivity and Collaboration for System Integrators and Machine Builders
Features	<ul style="list-style-type: none"> - AC500-eCo, AC500 with local I/O, TCP/IP, Modbus, CS-31, IEC60870-5 - All 5 IEC 61131-3 languages IL, LD, FBD, SFC, ST, plus CFC - Drive application programming (IEC 61131-3) - Mint WorkBench for motion applications - RobotStudio Basic - PLC firmware update, download and online change to single or several PLCs - PLC simulation and debugging - Language packs available for EN, DE, ES, FR, CN 	Automation Builder Basic features plus <ul style="list-style-type: none"> - Integrated engineering for Panel, Drive, Motion, Robotics - AC500 PROFIBUS, PROFINET, EtherCAT, CAN - AC500 Safety (1) - Drive Manager 	Automation Builder Standard features plus <ul style="list-style-type: none"> - C/ C++ application programming interface - EPLAN Interface AC500/ AC500-eCo - Advanced CSV data exchange - Project compare"
Minimum PC requirements	1 GHz, 3 GB RAM, 10 GB free disk space		
Recommended Operating Systems	Windows 7 32/64-bit, Windows 8.1 32/64-bit		
Target Systems	<ul style="list-style-type: none"> - PLC AC500-eCo, AC500, AC500-XC, ACS880, DCT880 - Robot Controller IRC5 - NextMove motion controllers, MicroFlex and MotiFlex drives 	<ul style="list-style-type: none"> - AC500-S (1), - Control Panel CP600 and CP600-WEB 	
Supported devices on PLC fieldbus	-	<ul style="list-style-type: none"> - All I/O and fieldbus modules for AC500 family - ACS355, ACQ810, ACS850, ACS880, DCT880, ACSM1, MicroFlex e150, Motiflex e180, IRC5 on selected fieldbuses 	
Included components	<ul style="list-style-type: none"> - IEC61131-3 Editor - PS553-DRIVES drive library - RobotStudio (Basic license) - Mint WorkBench - OPC server and clients, service tool, PLC gateway, IP configuration and visualization 	Automation Builder Basic plus <ul style="list-style-type: none"> - Drive Manager - Panel Builder 600 	Automation Builder Standard plus <ul style="list-style-type: none"> - GNU compiler, C/ C++ programming (2) - EPLAN interface
Additional options	<ul style="list-style-type: none"> - RobotStudio Premium license - Panel Builder 600 license - Drive composer pro license 	<ul style="list-style-type: none"> - PS501-S safety library - PS541-HMI visualization - PS552-MC-E PLCopen® motion library 	

(1) requires PS501-S safety library.
 (2) for AC500 and AC500-XC targets.

Automation Builder

Libraries features

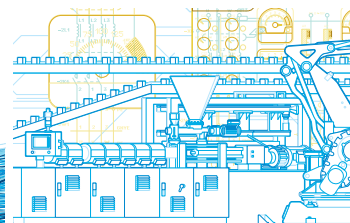
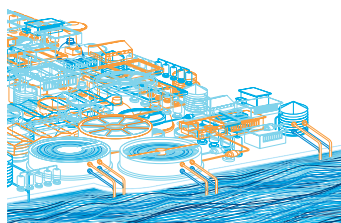
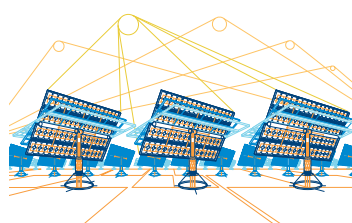
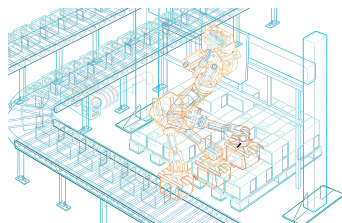

PS552-MC-E	PS562-SOLAR	PS563-WATER	PS564-TEMPCTRL *
Motion control library	Solar tracker solution library	Water solution library	Temperature Control Library
<p>Library enabling fast and standardized engineering according to PLCopen® standard when using ABB's AC500 PLC for motion control, especially together with ABB's motion control Drives.</p> <p>Covers different motion control options for single and multiaxis motion control applications:</p> <ul style="list-style-type: none"> – Drive-Based and PLC-Based motion – In PLC based motion, the position control loop could be closed in the PLC or drive (with synchronized network) – Single axis, multiaxis and coordinated motion – Defined Jerk limitation by polynomial interpolation – Spline interpolation or polynomial interpolation for cam curves, position velocity or acceleration profiles available – Possible to switch over between different movements and cam curves directly – latch functionality by utilizing fast drive inputs for ACS350, ACS800, ACSM1 – Drive based motion: commands from PLC, drives perform interpolation and control loop – Supports the new Pulse Train Output module FM562. <p>PLCopen® functions:</p> <ul style="list-style-type: none"> – Administrative Function Blocks – Single axis Function Blocks – Multiple axis Function Blocks – Homing Function Blocks – Coordinated Motion Function Blocks – Additional ABB specific Function Blocks for further simplification. 	<p>Library for solar tracking applications enabling fast engineering, especially together with ABB's drives and motors</p> <p>Covers different tracker configurations and different algorithms for accuracy needs</p> <ul style="list-style-type: none"> – Control of trackers in parabolic trough, power tower, PV and CPV applications. <p>Complete library package for different tracking use cases, plug and play: Example program with detailed explanations and visualizations</p> <ul style="list-style-type: none"> – Control of the tracker adaptable to different needs and conditions, to achieve maximum efficiency of installation – Exact positioning of different axes with the following accuracies: <ul style="list-style-type: none"> - NOAA algorithm 0.03 Grad - NREL algorithm 0.0003 Grad. – Input / sensor adaptation – Communication – Different actuators / drives control – All needed modes for simple commissioning and manual operation: <ul style="list-style-type: none"> - Fast and simple calibration of the trackers, offering manual repositioning and fine tuning - Safety positions - Back tracking. 	<p>Library supporting the most common functions in many water applications</p> <p>Flexible data logging options:</p> <ul style="list-style-type: none"> – Especially suited for remote communication like GSM/GPRS – Timestamp in logging – Integrated variants for simple use with IEC 60870 – Logging to files: storage capacity only dependent on memory availability – Flexible log conditions (cyclic, event or tolerance based). <p>Support for pumping station functions with different operation modes</p> <ul style="list-style-type: none"> – Standard multidrive functions (PLC based) – Advanced functionality together with ABB ACS and ACQ810 drives – Detailed diagnosis – Energy efficiency functions – Multidrive functions – Flow estimation. <p>Control Panel CP600 support for ACQ810: Fast and simple configuration for pumping stations with reduced programming effort via pre-built visualization screen templates.</p> <p>Application examples for fast engineering and startup.</p>	<p>Library packet for advanced temperature control applications</p> <p>Includes extended, flexible PID functionality with Auto-tune for temperature control</p> <ul style="list-style-type: none"> – Enhanced response time and reduced overshoots and oscillations – Option to optimize control for very different heating and cooling characteristics. – Enhanced tolerance to thermocouple input noise – Normal and standby- setpoints – Multi-level temperature monitoring and alarms provides flexible operation and protection for machine and process – Logging enables complete overview of the actual situation and past behavior – Configurable output timing, synchronization for peak load shaving in multi-zone setups – Simulation blocks enable off-line setup and pre-test of a new project – Group-programming <p>Example projects, including adaptable HMI project for CP600 family, well suited for multi zone and grouped temperature control e.g. in Extrusion:</p> <ul style="list-style-type: none"> – Easy to use operator interface – Provides quick access to setup, monitoring and tuning screens for multiple zones – Easily expandable to a large number of zones – Zones: heat-, cool-only or heat-and-cool
Package with self installing software and license code on USB-stick.	Package with self installing software and license code on USB-stick.	Package with self installing software and license code on USB-stick.	License Package; (Software can be downloaded)
All AC500 CPUs (options and no. of blocks/functions and performance will depend on CPU size and memory).	NOAA: PM554-XX and above NREL: PM573-ETH and above.	All AC500 CPUs. Logging: PM573 and above.	All AC500 CPUs.

* in preparation

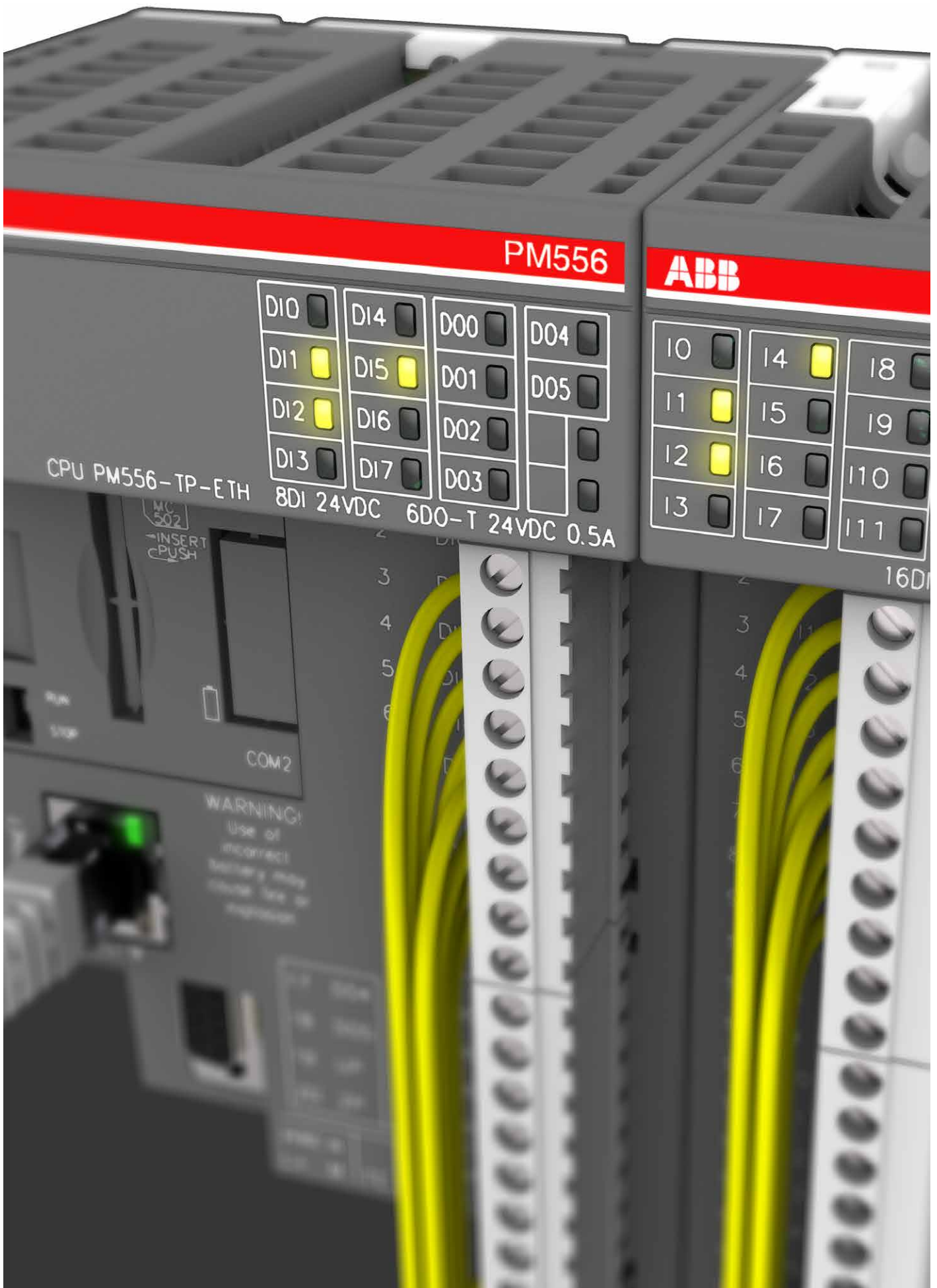

AC500-eCo

Entry level PLC solutions

Key features	3/38
Entry level PLC solutions	3/39
Technical data	3/42
System data	3/49

AC500-eCo

Key features

3

- Up to 10 I/O modules connected to the CPU
- Compatible with all standard I/O modules (S500 and S500-eCo)
- Digital I/O module with configurable I/O available



High performance with large memory variant available

- Three different types of terminal blocks available
- Integrated onboard I/O
- AC versions with integrated power supply

Comprehensive communication options:

- Ethernet for communication and Web server for user defined visualization
- Up to two serial ports for decentralized I/O and communication

AC500-eCo

Entry level PLC solutions



PM554

AC500-eCo CPUs

- 1 RS485 serial interface (2nd is optional)
- Centrally expandable with up to 10 I/O modules (standard S500 and/or S500-eCo modules can be mixed)
- Optional SD card adapter for data storage and program backup
- Variants with integrated Ethernet (Ethernet includes web server)
- Minimum cycle time per instruction: Bit 0.08 μ s, Word 0.1 μ s, Float-point 1.2 μ s.

Program memory	Onboard I/Os	Relay / Transistor outputs	Integrated communication	Power supply	Type	Order code	Price	Weight (1 pce)
kB	DI/DO/AI/AO							kg

PM554: digital I/Os

128	8 / 6 / - / -	Transistor	-	24 V DC	PM554-TP	1SAP120600R0001		0.300
128	8 / 6 / - / -	Relay	-	24 V DC	PM554-RP	1SAP120700R0001		0.400
128	8 / 6 / - / -	Relay	-	100-240 V AC	PM554-RP-AC	1SAP120800R0001		0.400
128	8 / 6 / - / -	Transistor	Ethernet	24 V DC	PM554-TP-ETH	1SAP120600R0071		0.400

PM556: digital I/Os, 512 kB program memory

512	8 / 6 / - / -	Transistor	Ethernet	24 V DC	PM556-TP-ETH	1SAP121200R0071		0.400
-----	---------------	------------	----------	---------	--------------	-----------------	--	-------

PM564: digital and analog I/Os (1)

128	6 / 6 / 2 / 1	Transistor	-	24 V DC	PM564-TP	1SAP120900R0001		0.300
128	6 / 6 / 2 / 1	Relay	-	24 V DC	PM564-RP	1SAP121000R0001		0.400
128	6 / 6 / 2 / 1	Relay	-	100-240 V AC	PM564-RP-AC	1SAP121100R0001		0.400
128	6 / 6 / 2 / 1	Transistor	Ethernet	24 V DC	PM564-TP-ETH	1SAP120900R0071		0.300
128	6 / 6 / 2 / 1	Relay	Ethernet	24 V DC	PM564-RP-ETH	1SAP121000R0071		0.400
128	6 / 6 / 2 / 1	Relay	Ethernet	100-240 V AC	PM564-RP-ETH-AC	1SAP121100R0071		0.400

Terminal blocks (9 or 11 poles) are necessary for each AC500-eCo I/O. The terminal blocks must be ordered separately.

(1) All analog inputs on PM564 can be configured as digital inputs.



PM556



PM564

AC500-eCo

Entry level PLC solutions

3



DI561

S500-eCo I/O modules

- For central expansion of the AC500 or AC500-eCo CPUs
- For decentralized expansion in combination with communication interface module DC551-CS31, PROFINET® CI50x modules, CI592-CS31, PROFIBUS® modules CI54x, and CANopen® modules CI58x (not usable with DC505-FBP module and CI590-CS31-HA).

Digital I/O

- DC: Channels can be configured individually as inputs or outputs.

Number of DI/DO/DC	Input signal	Output type	Output signal	Terminal block required		Type	Order code	Price	Weight (1 pce) kg
				9 poles	11 poles				
8 / - / -	24 V DC	-	-	1	-	DI561	1TNE968902R2101		0.12
16 / - / -	24 V DC	-	-	1	1	DI562	1TNE968902R2102		0.12
8 / - / -	100-240 V AC	-	-	1	1	DI571	1TNE968902R2103		0.15
16 / - / -	100-240 V AC	-	-	1	1	DI572 ¹⁾	1SAP230500R0000		0.19
- / 8 / -	-	Transistor	24 V DC, 0.5 A	-	1	DO561	1TNE968902R2201		0.12
- / 16 / -	-	Transistor	24 V DC, 0.5 A	1	1	DO562	1SAP230900R0000		0.16
- / 8 / -	-	Relay	24 V DC, 120 / 240 V AC, 2 A	-	1	DO571	1TNE968902R2202		0.15
- / 8 / -	-	Triac	100-240 V AC, 0.3 A	1	1	DO572	1TNE968902R2203		0.12
- / 16 / -	-	Relay	24 V DC, 120 / 240 V AC, 2 A	1	1	DO573	1SAP231300R0000		0.19
8 / 8 / -	24 V DC	Transistor	24 V DC, 0.5 A	1	1	DX561	1TNE968902R2301		0.12
8 / 8 / -	24 V DC	Relay	24 V DC, 120 / 240 V AC, 2 A	1	1	DX571	1TNE968902R2302		0.15
- / - / 16	24 V DC	Transistor	24 V DC, 0.1A	HE10-20	-	DC561	1TNE968902R2001		0.12
- / - / 16	24 V DC	Transistor	24 V DC, 0.5 A	1	1	DC562	1SAP231900R0000		0.15

Terminal blocks (9 or 11 poles) are necessary for each S500-eCo I/O. The terminal blocks must be ordered separately.
¹⁾ in preparation



AI562

Analog I/O

- Each channel can be configured individually
- Resolution:
 - AI561, AO561, AX561: 12 bits/11 bits + sign
 - AI562, AI563: 15 bits + sign.

Number of AI/AO	Input signal	Output signal	Terminal block required		Type	Order code	Price	Weight (1 pce) kg
			9 poles	11 poles				
4 / 0	±2.5 V, ±5 V, 0...5 V, 0...10 V, 0...20 mA, 4...20 mA	-	1	1	AI561	1TNE968902R1101		0.12
2 / 0	PT100, PT1000, Ni100, Ni1000, Resistance: 150 Ω, 300 Ω	-	-	1	AI562	1TNE968902R1102		0.12
4 / 0	S, T, R, E, N, K, J, Voltage range: ±80 mV	-	1	1	AI563	1TNE968902R1103		0.12
0 / 2	-	-10...+10 V, 0...20 mA, 4...20 mA	-	1	AO561	1TNE968902R1201		0.12
4 / 2	±2.5 V, ±5 V, 0...5 V, 0...10 V, 0...20 mA, 4...20 mA	-10...+10 V, 0...20 mA, 4...20 mA	1	1	AX561	1TNE968902R1301		0.13

Terminal blocks (9 or 11 poles) are necessary for each S500-eCo I/O. The terminal blocks must be ordered separately.



AX561

AC500-eCo

Entry level PLC solutions



FM562

Positioning module

- For central expansion of the AC500 or AC500-eCo CPUs
- For decentralized expansion in combination with communication interface modules CI58X-CN, CI50X-PNIO or CI54X-DP
- Not for use in combination with communication interface modules DC551-CS31, DC505-FBP, CI51X or CI59X
- The FM562 module provides Pulse Train Outputs for 2 axes. Profile generator integrated.

Number of axis	Input signal	Output signal	Terminal block required		Type	Order code	Price	Weight (1 pce) kg
			9 poles	11 poles				
2	4 digital inputs 24 V (2 per axis)	4 pulse outputs RS422 (2 per axis)	1	1	FM562	1SAP233100R0001		0.15

Terminal blocks (9 or 11 poles) are necessary for each S500-eCo I/O. The terminal blocks must be ordered separately. Library PS562-MC-E is required for programming this module.

Accessories

Description	Type	Order code	Price	Weight (1 pce) kg
SD Memory Card 2 GB needs the MC503 option	MC502	1SAP180100R0001		0.020
SD Memory Card adapter	MC503	1TNE968901R0100		0.010
Programming cable USB => RS485 Sub-D, 3 m	TK503	1TNE968901R1100		0.400
Programming cable USB => RS485 Terminal block, 3 m	TK504	1TNE968901R2100		0.400
RS485 isolator, Sub-D 9 poles / Terminal 5 poles for COM1	TK506	1SAP186100R0001		0.080
Real time clock option board, battery CR2032 not included	TA561-RTC (1)	1SAP181400R0001		0.007
RS485 serial adapter COM2, pluggable screw terminal block included	TA562-RS	1TNE968901R4300		0.007
Combined Real Time Clock option with RS485 serial adapter COM2, pluggable screw terminal block, included	TA562-RS-RTC (1)	1SAP181500R0001		0.012
Wall Mounting Accessory for AC500-eCo CPU and S500-eCo I/O modules (100 pieces per case)	TA566	1TNE968901R3107		0.450
Set of accessories: 6 x plastic cover for option slot, 6 x 5 pole terminal block, 6 x 5 pole screw terminal block for COM2 serial interface.	TA570	1TNE968901R3203		0.090
Digital input simulator for onboard I/O of CPU, 6 x switch, 24 V DC	TA571-SIM	1TNE968903R0203		0.040

(1) Standard battery CR 2032 has to be purchased separately.



TK506

TA561-RTC



TA562-RS



TA562-RS-RTC



TA570

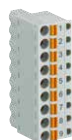

TA565-9



TA564-11



TA563-9

Terminal blocks for S500-eCo I/O modules and AC500-eCo CPUs

Number of poles	Connection type	Cable entry	Type	Order code	Price	Weight (1 pce) kg
9	Screw	Side	TA563-9	1TNE968901R3101		0.017
11	Screw	Side	TA563-11	1TNE968901R3102		0.020
9	Screw	Front	TA564-9	1TNE968901R3103		0.026
11	Screw	Front	TA564-11	1TNE968901R3104		0.035
9	Spring	Front	TA565-9	1TNE968901R3105		0.016
11	Spring	Front	TA565-11	1TNE968901R3106		0.020



Only ABB terminal blocks must be used with AC500-eCo. Sales package for these terminal blocks = 6.

AC500-eCo

Technical data

AC500-eCo CPUs

Type	PM554-TP	PM554-RP	PM554-RP-AC			PM554-TP-ETH	PM556-TP-ETH
Supply voltage	24 V DC		100-240 V AC			24 V DC	
Current consumption on	24 V DC		100 V AC	240 V AC	24 V DC		
Min. typ. (module alone)	0.06 A	0.08 A	0.02 A	0.012 A	0.07 A	0.07 A	
Max. typ. (I/Os)	0.18 A	0.22 A	0.2 A	0.11 A	0.19 A	0.19 A	
Program memory	128 kB					512 kB	
Integrated data memory	14 kB thereof 2 kB saved					130 kB thereof 2 kB saved	
Web server's data for user RAM disk	-					512 kB	1024 kB
Data buffering (of saved data)	flash memory						
Real-time clock (option with battery back-up) (1)	●						
Program execution							
Cyclical	●						
Time controlled	●						
Multi tasking	no, 1 task + 1 interrupt task max.						
Interruption	●						
User program protection by password	●						
Cycle time for 1 instruction (minimum)							
Binary	0.08 µs						
Word	0.1 µs						
Floating	1.2 µs						
Onboard digital inputs							
Channels	8						
Signal voltage	24 V DC						
Onboard digital outputs							
Channels	6						
Relay / Transistor	Transistor	Relay	Relay	Relay	Transistor	Transistor	
Rated voltage	24 V DC	240 V AC	240 V AC	240 V AC	24 V DC	24 V DC	
Nominal current per channel	0.5 A	2 A resistive	2 A resistive	2 A resistive	0.5 A	0.5 A	
Onboard analog inputs							
Channels	-						
signal ranges	-						
Onboard analog outputs							
Channels	-						
signal ranges	-						
Max. number of centralized inputs/outputs							
Max. number of extension modules on I/O bus	up to max. 10 (S500 and/or S500-eCo modules allowed)						
Digital	inputs	320 + 8					
	outputs	320 + 6					
Analog	inputs	160					
	outputs	160					
Max. number of decentralized inputs/outputs							
I/O modules	decentralized	on CS31 bus: up to 31 stations with up to 120 DI / 120 DO each or up to 32 AI/32 AO per station					
Internal interfaces							
COM1							
RS485	●						
Sub-D connection	●						
Programming, Modbus, ASCII, CS31	●						
COM2 (option) (2)							
RS485	●						
Terminal block	●						
Programming, Modbus, ASCII	●						
Ethernet							
RJ45	-					●	
Ethernet functions: Programming, Modbus TCP/IP, UDP/IP, integrated Web server, DHCP, FTP server, SNTP client	-					●	
RUN/STOP switch	●						
LED display for power, status and error	●						
Approvals	see detailed overview page 168 or www.abb.com/plc						

(1) Real-time clock requires optional TA561-RTC or TA562-RS-RTC.

(2) COM2 requires TA562-RS-RTC or TA562-RS.

AC500-eCo

Technical data

AC500-eCo CPUs

Type	PM564-TP	PM564-RP	PM564-RP-AC		PM564-TP-ETH	PM564-RP-ETH	PM564-RP-ETH-AC	
Supply voltage	24 V DC		100-240 V AC		24 V DC		100-240 V AC	
Current consumption on	24 V DC		100 V AC	240 V AC	24 V DC		100 V AC	240 V AC
Min. typ. (module alone)	0.095 A	0.11 A	0.02 A	0.011 A	0.10 A	0.12 A	0.023 A	0.014 A
Max. typ. (I/Os)	0.21 A	0.24 A	0.21 A	0.125 A	0.22 A	0.25 A	0.22 A	0.13 A
Program memory	128 kB							
Integrated data memory	14 kB thereof 2 kB saved							
Web server's data for user RAM disk	-				512 kB			
Data buffering (of saved data)	flash memory							
Real-time clock (option with battery back-up) (1)	●							
Program execution								
Cyclical	●							
Time controlled	●							
Multi tasking	no, 1 task + 1 interrupt task max.							
Interruption	●							
User program protection by password	●							
Cycle time for 1 instruction (minimum)								
Binary	0.08 µs							
Word	0.1 µs							
Floating	1.2 µs							
Onboard digital inputs								
Channels	6							
Signal voltage	24 V DC							
Onboard digital outputs								
Channels	6							
Relay / Transistor	Transistor	Relay	Relay	Relay	Transistor	Relay	Relay	Relay
Rated voltage	24 V DC	240 V AC	240 V AC	240 V AC	24 V DC	240 V AC	240 V AC	240 V AC
Nominal current per channel	0.5 A	2 A resistive	2 A resistive	2 A resistive	0.5 A	2 A resistive	2 A resistive	2 A resistive
Onboard analog inputs								
Channels	2							
signal ranges	0...10 V / can be configured as digital input 24 V DC							
Onboard analog outputs								
Channels	1							
signal ranges	0...10 V / 0...20 mA / 4...20 mA							
Max. number of centralized inputs/outputs								
Max. number of extension modules on I/O bus	up to max. 10 (S500 and/or S500-eCo modules allowed)							
Digital	inputs	320 + 8						
	outputs	320 + 6						
Analog	inputs	160 + 2						
	outputs	160 + 1						
Max. number of decentralized inputs/outputs								
I/O modules	decentralized	on CS31 bus: up to 31 stations with up to 120 DI / 120 DO each or up to 32 AI/32 AO per station						
Internal interfaces								
COM1								
RS485	●							
Sub-D connection	●							
Programming, Modbus, ASCII, CS31	●							
COM2 (option) (2)								
RS485	●							
Terminal block	●							
Programming, Modbus, ASCII	●							
Ethernet								
RJ45	-				●			
Ethernet functions: Programming, Modbus TCP/IP, UDP/IP, integrated Web server, DHCP, FTP server, SNMP client	-				●			
RUN/STOP switch	●							
LED display for power, status and error	●							
Approvals	see detailed overview page 168 or www.abb.com/plc							

(1) Real-time clock requires optional TA561-RTC or TA562-RS-RTC.

(2) COM2 requires TA562-RS-RTC or TA562-RS.

AC500-eCo

Technical data

Digital S500-eCo I/O modules

Type	DI561	DI562	DI571	DI572	DO561	DO562
Supply voltage	-	-	-	-	24 V DC	24 V DC
Current consumption on UP Max. typ. (without load current)	-	-	-	-	0.005 A	0.005 A

Number of channels per module

Digital	inputs	8	16	8 (AC)	16 (AC)	-	-
	outputs	-	-	-	-	8	16
Configurable as Input or Output DC		-	-	-	-	-	-
Relay / Transistor		-	-	-	-	Transistor	Transistor

Additional configuration of channels as:

Fast Counter	no					not applicable
--------------	----	--	--	--	--	----------------

Digital inputs

Input signal voltage	24 V DC		100-240 V AC		-	-
Input time delay	typically 4...8 ms		typically 15 ms / 30 ms		-	-

Input current per channel

At Input voltage	24 V DC	typically 5 mA	-	-	-	-
	5 V DC	typically 1 mA	-	-	-	-
	15 V DC	> 2.5 mA	-	-	-	-
	30 V DC	< 8 mA	-	-	-	-
	40 V AC	-	-	< 3 mA	-	-
	164 V AC	-	-	> 6 mA	-	-

Output current

Nominal current per channel	-	-	-	-	0.5 A at UP = 24 V	-
Maximum (total current of all channels)	-	-	-	-	4 A	8 A
Residual current at signal state 0	-	-	-	-	< 0.5 mA	-
Demagnetization when switching off inductive loads	-	-	-	-	must be provided externally	

Switching frequency

For resistive load	-	-	-	-	limited by CPU cycle time	
For inductive load	-	-	-	-	max. 0.5 Hz	
For lamp load	-	-	-	-	max. 11 Hz at max. 5 W	
Short circuit / overload proofness	-	-	-	-	no	
Overload indication (I > 0.7 A)	-	-	-	-	no	
Output current limiting	-	-	-	-	no	
Proofness against reverse feeding of 24 V signals	-	-	-	-	no	

Contact rating

For resistive load, max.	-	-	-	-	-	-
For inductive load, max.	-	-	-	-	-	-
For lamp load	-	-	-	-	-	-

Lifetime (switching cycles)

Mechanical lifetime	-	-	-	-	-	-
Lifetime under load	-	-	-	-	-	-

Maximum cable length for connected process signals

Cable	shielded	500 m				
	unshielded	300 m			150 m	

Potential isolation

Per module		●	●	●	●	●
Between the channels	input	-	per group of 8	●	per group of 8	-
	output	-	-	-	-	-
Voltage supply for the module's logic		internal via I/O bus				

Fieldbus connection

Suitable communication interface module	CI501-PNIO, CI502-PNIO, CI504-PNIO, CI506-PNIO, CI541-DP, CI542-DP, CI581-CN, CI582-CN, DC551-CS31, CI592-CS31
---	--

AC500-eCo

Technical data

Digital S500-eCo I/O modules

Type	DO571	DO572	DO573
Supply voltage	24 V DC		
Current consumption on UP Max. typ. (without load current)	0.050 A	–	0.050 A
Number of channels per module			
Digital			
inputs	–	–	–
outputs	8	8	16
Configurable as Input or Output DC	–	–	–
Relay / Transistor	Relay	triac (AC)	Relay
Process voltage			
DC	24 V	–	–
Digital inputs			
Input signal voltage	–	–	–
Input time delay	–	–	–
Input current per channel			
At Input voltage	24 V DC	–	–
	5 V DC	–	–
	15 V DC	–	–
	30 V DC	–	–
Output current			
Nominal current per channel	2 A (24 V DC / 120 V AC / 240 V AC, resistive load)	0.3 A at 100...240 V AC	2 A (24 V DC / 120 V AC / 240 V AC, resistive load)
Maximum (total current of all channels)	2 x 8 A	2.4 A / 8 x 0.3 A	max 10 A per group (20 A per module)
Residual current at signal state 0	–	1.1 mA rms at 132 V AC and 1.8 mA rms at 264 V AC	–
Demagnetization when switching off inductive loads	must be performed externally		
Switching frequency			
For resistive load	1 Hz max.	10 Hz max.	1 Hz max.
For inductive load	–	–	–
For lamp load	1 Hz max.	10 Hz max.	1 Hz max.
Short circuit / overload proofness	no	–	–
Overload indication (I > 0.7 A)	no	–	–
Output current limiting	no	–	–
Proofness against reverse feeding of 24 V signals	yes	–	yes
Contact rating			
For resistive load, max.	2 A	0.3 A	2 A
For inductive load, max.	–	–	–
For lamp load	200 W at 230 V AC 30 W at 24 V DC	–	200 W at 230 V AC 30 W at 24 V DC
Lifetime (switching cycles)			
Mechanical lifetime	100 000	–	100 000
Lifetime under load	100 000 at rated load	–	100 000 at rated load
Maximum cable length for connected process signals			
Cable	shielded	500 m	–
	unshielded	150 m	–
Potential isolation			
Per module	between outputs and logic	●	between outputs and logic
Between the channels	input	–	–
	output	per group of 4	●
Voltage supply for the module's logic	internal via I/O bus		
Fieldbus connection			
Suitable communication interface module	CI501-PNIO, CI502-PNIO, CI504-PNIO, CI506-PNIO, CI541-DP, CI542-DP, CI581-CN, CI582-CN, DC551-CS31, CI592-CS31		

AC500-eCo

Technical data

Digital S500-eCo I/O modules

Type		DX561	DX571	DC561	DC562
Supply voltage		24 V DC			
Current consumption on UP					
Max. typ. (without load current)		0.005 A	0.050 A	0.010 A	0.010 A
Number of channels per module					
Digital	inputs	8	8	-	-
	outputs	8	8	-	-
Configurable as Input or Output DC		-	-	16	16
Relays / Transistor		Transistor	Relay	Transistor	Transistor
Process voltage					
DC		24 V	24 V	24 V	24 V
Digital inputs					
Input signal voltage		24 V DC	24 V DC	24 V DC	24 V DC
Input time delay		typically 4...8 ms			typically 8 ms
Input current per channel					
At Input voltage	24 V DC	typically 5 mA	typically 5 mA	typically 4 mA	typically 5 mA
	5 V DC	< 1 mA	< 1 mA	< 1 mA	typically 1 mA
	15 V DC	> 2.5 mA	> 2.5 mA	> 2.5 mA	> 2.5 mA
	30 V DC	< 6.5 mA	< 6.5 mA	< 6 mA	< 8 mA
Output current					
Nominal current per channel		0.5 A at UP = 24 V DC	2 A (24 V DC / 120 V AC / 240 V AC, resistive load)	0.1 A at UP = 24 V DC	0.5 A at UP = 24 V DC
Maximum (total current of all channels)		4 A	2 x 8 A	1.6 A	8 A
Residual current at signal state 0		< 0.5 mA	-	< 0.5 mA	< 0.5 mA
Demagnetization when switching off inductive loads		must be performed externally			
Switching frequency					
For resistive load		Limited by CPU cycle time	1Hz max.	Limited by CPU cycle time	
For inductive load		0.5 Hz max.	-	0.5 Hz max.	0.5 Hz max.
For lamp load		11 Hz max. at max. 5 W	1 Hz max.	-	11 Hz max. at max. 5 W
Short circuit / overload proofness		no			
Overload indication (I > 0.7 A)		no			
Output current limiting		no			
Proofness against reverse feeding of 24 V signals		no	yes	no	no
Contact rating					
For resistive load, max.		-	2 A	-	-
For inductive load, max.		-	-	-	-
For lamp load		-	200 W at 230 V AC 30 W at 24 V DC	-	-
Lifetime (switching cycles)					
Mechanical lifetime		-	100 000	-	-
Lifetime under load		-	100 000 at rated load	-	-
Maximum cable length for connected process signals					
Cable	shielded	500 m			
	unshielded	150 m			
Potential isolation					
Per module		●	-	●	●
Between the channels	input	-	-	-	-
	output	-	per group of 4	-	-
Voltage supply for the module's logic		internal via I/O bus			
Fieldbus connection					
Suitable communication interface module		CI501-PNIO, CI502-PNIO, CI504-PNIO, CI506-PNIO, CI541-DP, CI542-DP, CI581-CN, CI582-CN, DC551-CS31, CI592-CS31			

AC500-eCo

Technical data

Analog S500-eCo I/O modules

Type		AI561	AO561	AX561	AI562	AI563
Supply voltage		24 V DC				
Current consumption on UP						
Max. typ. (without load current)		0.100 A	0.100 A	0.140 A	0.040 A	0.100 A
Number of channels per module						
Analog	inputs	4	–	4	2	4
	outputs	–	2	2	–	–
Inputs, individually configurable						
-2.5...+2.5 V	11 bits + sign	●	–	●	–	–
-5...+5 V	11 bits + sign	●	–	●	–	–
-10...+10 V	11 bits + sign	–	–	–	–	–
0...5 V	12 bits	●	–	●	–	–
0...10 V	12 bits	●	–	●	–	–
0...20 mA, 4...20 mA	12 bits	●	–	●	–	–
RTD						
Pt100		–	–	–	●	–
	-50...+400 °C (2/3-wire)	–	–	–	●	–
Pt1000		–	–	–	●	–
	-50...+400 °C (2/3-wire)	–	–	–	●	–
Ni100 / Ni1000		–	–	–	●	–
	-50...+150 °C (2/3-wire)	–	–	–	●	–
Resistor	0...150 Ω/0...300 Ω	–	–	–	●	–
Thermocouple	Types J, K, T, N, S, E, R	–	–	–	–	●
Voltage	-80...+80 mV	–	–	–	–	●
Outputs, individually configurable						
-10...+10 V		–	●	●	–	–
0...20 mA		–	●	●	–	–
4...20 mA		–	●	●	–	–
Potential isolation						
Per module		–	–	–	●	●
Fieldbus connection						
Suitable communication interface module		CI501-PNIO, CI502-PNIO, CI504-PNIO, CI506-PNIO, CI541-DP, CI542-DP, CI581-CN, CI582-CN, DC551-CS31, CI592-CS31				

AC500-eCo

Technical data

FM562 positioning module

The FM562 module contains Pulse Train Outputs for 2 axes. Profile generator for simple motion control tasks are integrated. The RS422 outputs allow a direct connection to Stepper- or Servo drives. Function blocks in PLCopen® motion control style allow the integration of the module in an application. These function blocks are contained in the library PS552-MC-E.

Type	FM562	
Functionality		
Number of axis	2	
Digital inputs	2 digital inputs per axis Function: for axis enable or limit switch	
Pulse outputs	Modes cw/ccw or pulse/direction Built in profile generators	
Data of the digital inputs		
Signal voltage	24 V DC	
Input current at 24 V DC	typically 5 mA	
Potential isolation	by groups of 2	
Data of pulse outputs		
Signal	RS422 (differential)	
Frequency range	0...250 kHz	
Potential isolation	RS422 outputs of both axis in one group isolated against the inputs, the process voltage and the PLC CPU logic	
Maximum cable length for digital inputs		
Cable	shielded	500 m
	unshielded	300 m
Maximum cable length for pulse outputs		
Cable	shielded	300 m
	unshielded	30 m
Process voltage UP		
Nominal voltage	24 V DC	
Current consumption on UP	typically 0.04 A	
Reverse polarity protection	●	
Potential isolation		
Per module	●	
Voltage supply for the internal logic	From UP / ZP with isolation	
Fieldbus connection		
Suitable communication interface module	CI501-PNIO, CI502-PNIO, CI504-PNIO, CI506-PNIO, CI541-DP, CI542-DP, CI581-CN, CI582-CN	

AC500-eCo

System data

Environmental conditions

Process and supply voltages

24 V DC	Process and supply voltage	24 V DC (-15 %, +20 % without ripple)
	Absolute limits	19.2...30 V inclusive ripple
	Ripple	< 5 %
	Protection against reverse polarity	10 s
120 V AC	Line voltage	120 V AC (-15 %, +10 %)
	Frequency	47...62.4 Hz / 50...60 Hz (-6 %, +4 %)
230 V AC	Line voltage	230 V AC (-15 %, +10 %)
	Frequency	47...62.4 Hz / 50...60 Hz (-6 %, +4 %)
120–240 V AC	Wide-range supply	
	Line voltage	102...264 V / 120...240 V (-15 %, +10 %)
	Frequency	47...62.4 Hz / 50...60 Hz (-6 %, +4 %)

Allowed interruptions of power supply

DC supply	Interruption	< 10 ms, time between 2 interruptions > 1 s, PS2
AC supply	Interruption	< 0.5 periods, time between 2 interruptions > 1 s

Important: Exceeding the maximum power supply voltage (>30 V DC) for process or supply voltages could lead to unrecoverable damage of the system. The system could be destroyed. The creepage distances and clearances meet the requirements of the overvoltage category II, pollution degree 2. For the supply of the modules, power supply units according to PELV specifications must be used.

Climatic conditions

Temperature	Operation	0...60 °C (horizontal mounting of modules) 0...40 °C (vertical mounting of modules and output load reduced to 50 % per group)
	Storage	-40...+70 °C
	Transport	-40...+70 °C
Humidity	Without condensation	Max. 95 %
Air pressure	Operation	> 800 hPa / < 2000 m
	Storage	> 660 hPa / < 3500 m

Electromagnetic Compatibility

Radiated emission (radio disturbances)	Acc. to IEC61000-6-4
Conducted emission (radio disturbances)	Acc. to IEC61000-6-4
Electrostatic discharge (ESD)	Acc. to EN 61000-4-2, zone B, criterion B
Fast transient interference voltages (burst)	Acc. to EN 61000-4-4, zone B, criterion B
High energy transient interference voltages (surge)	Acc. to EN 61000-4-5, zone B, criterion B
Influence of radiated disturbances	Acc. to IEC 61000-4-3, zone B, criterion A
Influence of line-conducted interferences	Acc. to IEC 61000-4-6, zone B, criterion A

In order to prevent operating malfunctions, it is recommended, that the operating personnel discharge themselves prior to touching communication connectors or perform other suitable measures to reduce effects of electrostatic discharges. The connector of the I/O-Bus must not be touched during operation.

Mechanical data

Wiring method	Available types of terminal	Spring terminals, screw terminals
Degree of protection		IP 20 (if all terminal screws are tightened)
Vibration resistance		Acc. to IEC 61131-2
Shock resistance		Acc. to IEC 60068-2-27
Assembly position	Horizontal	no derating
	Vertical	max. ambient temp. 40°C and output load reduced to 50% per group
Assembly on DIN rail		Acc. to IEC 60715
Assembly with screws	DIN rail type	35 mm, depth 7.5 mm or 15 mm
	Screw diameter	4 mm
	Fastening torque	1.2 Nm

Main dimensions mm, inches

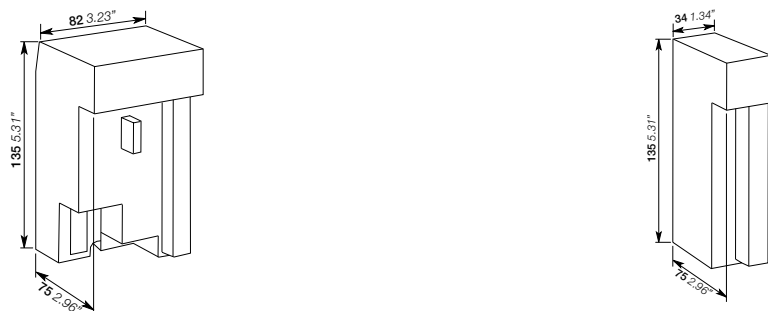

AC500-eCo

System data

Environmental tests

Climatic and mechanical tests

Storage	Cold withstand test	IEC 60068-2-1 Test Ab: cold withstand test -40 °C / 16 h
	Dry heat withstand test	IEC 60068-2-2 Test Bb: dry heat withstand test +70 °C / 16 h
Humidity	Damp heat test	IEC 60068-2-30 Test Db: Cyclic (12 h / 12 h) Damp-Heat Test 55 °C, 93 % r. H. / 25 °C, 95 % r. H., 2 cycles
	Insulation Test	Acc. to IEC 61131-2
Vibration resistance	DIN rail mounting	all three axes 5...11.9 Hz, continuous 3.5 mm 11.9...150 Hz, continuous 1 g
	With SD Memory Card inserted	15...150 Hz, continuous 1 g
Shock resistance	DIN rail mounting	IEC 60068-2-27: all 3 axes 15 g, 11 ms, half-sinusoidal

EMC immunity tests

Electrostatic discharge (ESD)	Electrostatic voltage in case of air discharge	8 kV
	Electrostatic voltage in case of contact discharge	6 kV
Fast transient interference voltages (burst)	Supply voltage units (AC, DC)	2 kV
	Digital inputs/outputs (24 V DC)	2 kV
	Digital inputs/outputs (120/230 V AC)	2 kV
	Analog inputs/outputs	1 kV
	CS31 system bus	2 kV
	Serial RS-485 interfaces (COM)	2 kV
	Ethernet	1 kV
High energy transient interference voltages (surge)	I/O supply, DC-out	1 kV
	Power supply AC	2 kV CM (1) / 1 kV DM (2)
	Power supply DC	1 kV CM (1) / 0.5 kV DM (2)
	DC I/O supply, add. DC-supply-out	0.5 kV CM (1) / 0.5 kV DM (2)
	Buses, shielded	1 kV CM (1)
Influence of radiated disturbances	AC-I/O unshielded	2 kV CM (1) / 1 kV DM (2)
	I/O analog, I/O DC unshielded	1 kV CM (1) / 0.5 kV DM (2)
Influence of line-conducted interferences	Test field strength	10 V/m
	Test voltage	3V zone B, 10 V is also met.

(1) CM = Common Mode.

(2) DM = Differential Mode.

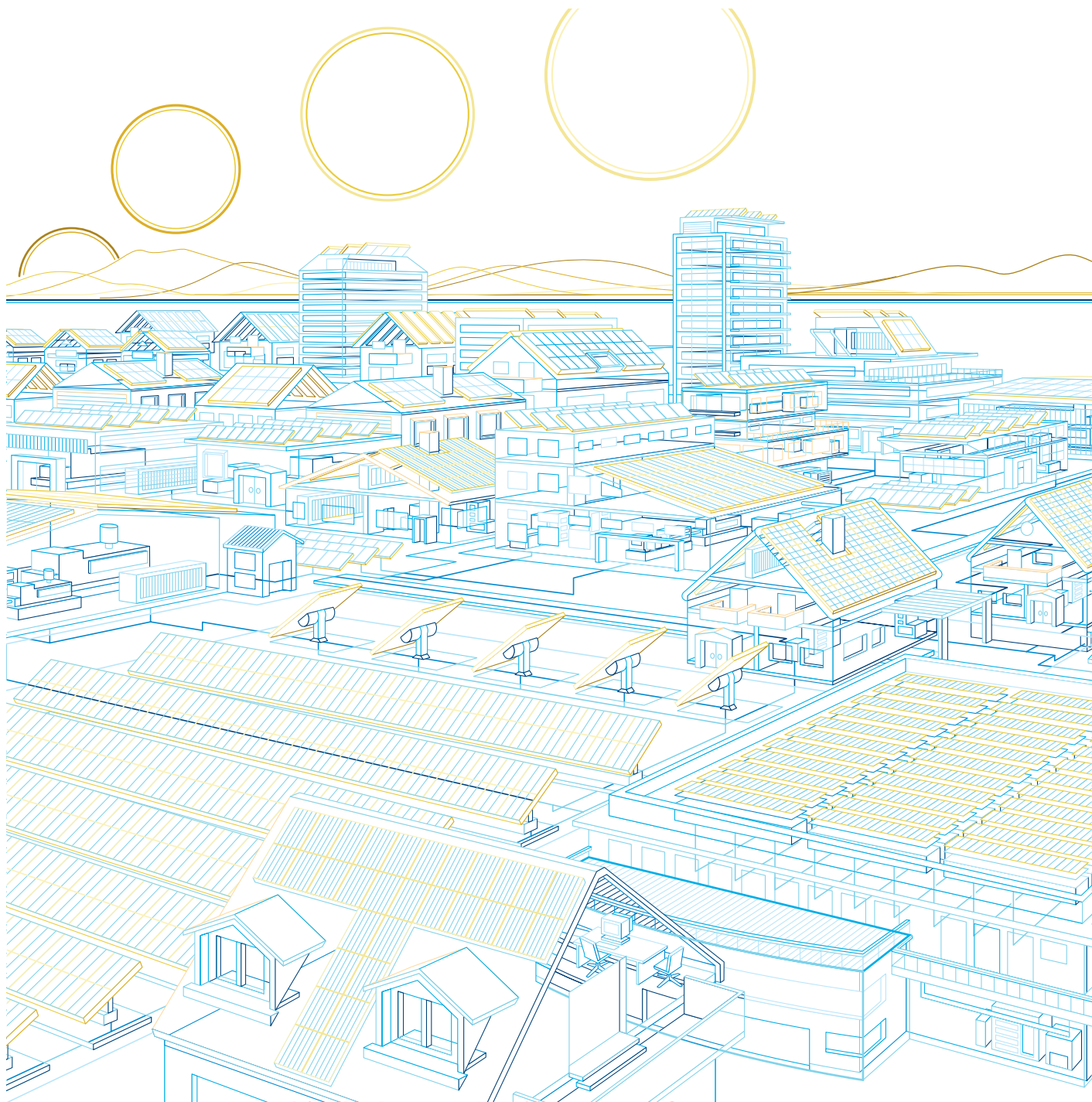



AC500

High performance modular PLC

Key features	4/54
High performance modular PLC	4/55
Technical data	4/61
System data	4/84

AC500

Key features

4

A high performance PLC:

- Highly modular
- From 8 to +80 000 I/Os
- More communications possibilities (Ethernet, Internet, PROFINET®, PROFIBUS®, Modbus®, CANopen®, EtherCAT® ...)

Common AC500 line benefits:
Automation Builder productivity suite, I/O modules scalable and flexible



- Eight programming languages available (five IEC61131-3, CFC, C-code and C++)
- Data logging
- SD card for program back-up
- High Availability (HA) option
- Screw or spring terminal for I/Os
- Extensive programming libraries

AC500

High performance modular PLC



PM572



PM592



PM595-4ETH-F



TB511-ETH



TB541-ETH

AC500 CPUs

- 2 internal serial interfaces, RS232 / RS485 configurable
- Display and 8 function keys for diagnosis and status
- Centrally expandable with up to 10 I/O modules, 320 I/Os (S500 and/or S500-eCo modules allowed)
- Simultaneous operation of up to 4 external communication modules in any desired combination
- Optional SD card for data storage and program backup
- Can also be used as slave on PROFIBUS® DP, DeviceNet or CANopen® via FieldBusPlug, CANopen® also using CM588 slave communication module
- Ethernet version provides web server and IEC 60870-5-104 remote control protocol.

Program memory kB	Cycle time in μ s per instruction min. Bit/Word/Float. point	Integrated communication	Type	Order code	Price	Weight (1 pce) kg
128	0.06 / 0.09 / 0.7	2 x serial	PM572	1SAP130200R0200		0.135
512	0.06 / 0.09 / 0.7	Ethernet (2), 2 x serial	PM573-ETH (1)	1SAP130300R0271		0.150
512	0.05 / 0.06 / 0.5	2 x serial	PM582	1SAP140200R0201		0.135
1024	0.05 / 0.06 / 0.5	Ethernet (2), 2 x serial	PM583-ETH (1)	1SAP140300R0271		0.150
2048	0.002 / 0.004 / 0.004	Ethernet (2), 2 x serial	PM590-ETH (1)	1SAP150000R0271		0.150
4096	0.002 / 0.004 / 0.004	Ethernet (2), 2 x serial	PM591-ETH (1)	1SAP150100R0271		0.150
4096	0.002 / 0.004 / 0.004	2 x Ethernet (2), 1 x serial	PM591-2ETH (1)(5)	1SAP150100R0277		0.150
4096	0.002 / 0.004 / 0.004	Ethernet (2), 2 x serial	PM592-ETH (1)(3)	1SAP150200R0271		0.150

AC500 CPU PM595

- 2 Ethernet interfaces with integrated switch and software configurable protocol (PROFINET, EtherCAT (4))
- 2 Ethernet interfaces
- 2 serial interfaces, RS232 / RS485 configurable
- Provides web server and IEC 60870-5-104 telecontrol protocol
- Centrally expandable with up to 10 I/O modules (S500 and/or S500-eCo modules allowed)
- Simultaneous operation of up to 2 external communication modules in any desired combination

Program memory MB	Cycle time in μ s per instruction min. Bit/Word/Float. point	Integrated communication	Type	Order code	Price	Weight (1 pce) kg
16	0.0006/0.001/0.001	2 x Ethernet (2 Ports switch), 2 x Ethernet (2), 2 x serial	PM595-4ETH-F	1SAP155500R0279		1.050

(1) Ethernet communication.

(2) Provides integrated web server and IEC 60870-5-104 remote control protocol on each interface independently.

(3) Provides integrated 4 GB flashdisk for user data storage and data logging.

(4) Availability on demand.

(5) Only to be used with dedicated terminal base TB523-2ETH.

Terminal base

- For mounting and connection of the CPUs and communication modules, not needed for PM595
- 1 to 4 plug-in communication modules
- Connection for communication coupler integrated in the CPU
- I/O interface for direct connection of up to 10 expansion modules
- Fieldbus-neutral FieldBusPlug-Slave interface
- Connection COM1: 9-pole pluggable terminal block
- Connection COM2: 9-pole Sub-D (not for TB523-2ETH).

Number of coupler slots	Connection for coupler integrated in the CPU	Type	Order code	Price	Weight (1 pce) kg
1	Ethernet RJ45	TB511-ETH	1SAP111100R0270		0.215
2	Ethernet RJ45	TB521-ETH	1SAP112100R0270		0.215
2	2x Ethernet RJ45	TB523-2ETH (1)	1SAP112300R0277		0.250
4	Ethernet RJ45	TB541-ETH	1SAP114100R0270		0.215

Note: These TBs are compatible with previous AC500 CPU versions (R01xx) and new ones (R02xx).

(1) Can only be used together the PM591-2ETH.

AC500

High performance modular PLC



CM572-DP



CM574-RCOM



CM578-CN



CM579-PNIO



DO524



AO523

Communication modules

Protocol	Connections	Type	Order code	Price	Weight (1 pce) kg
PROFIBUS® DP V0/V1 master	Sub-D socket 9 poles	CM572-DP	1SAP170200R0001		0.115
Ethernet (TCP/IP, UDP/IP, Modbus® TCP)	2 x RJ45 - integrated switch	CM597-ETH	1SAP193700R0001		0.115
CANopen® master	Terminal block 5 poles spring	CM578-CN	1SAP170800R0001		0.115
CANopen® slave	Terminal block 2 x 5 poles spring	CM588-CN	1SAP172800R0001		0.115
PROFINET® I/O RT controller	2 x RJ45 - integrated switch	CM579-PNIO	1SAP170901R0101		0.115
PROFINET® I/O RT device	2xRJ45 - integrated switch	CM589-PNIO	1SAP192900R0011		0.115
EtherCAT® master	2 x RJ45	CM579-ETHCAT	1SAP170902R0001		0.115
Serial + co-processor	2 x RS-232/485 on spring terminal blocks	CM574-RS	1SAP170400R0201		0.115
Serial RCOM	2 x RS-232/485 (1 x RCOM/1 x Console)	CM574-RCOM	1SAP170401R0201		0.115

I/O modules

- For central expansion of the AC500 or AC500-eCo CPUs
- For decentralized expansion in combination with communication interface modules on CS31, PROFINET® IO, PROFIBUS® DP, CANopen® modules
- DC: Channels can be configured individually as inputs or outputs
- Plug-in electronic modules, terminal unit required (refer to table below).

Digital I/O

Number of	Input signal	Output type	Output signal	Terminal units Screw / Spring	Type	Order code	Price	Weight (1 pce) kg
DI/DO/DC								
32 / - / -	24 V DC	-	-	TU515 / TU516	DI524	1SAP240000R0001		0.200
- / - / 16	24 V DC	Transistor	24 V DC, 0.5 A	TU515 / TU516	DC522	1SAP240600R0001		0.200
- / - / 24	24 V DC	Transistor	24 V DC, 0.5 A	TU515 / TU516	DC523	1SAP240500R0001		0.200
16 / - / 16	24 V DC	Transistor	24 V DC, 0.5 A	TU515 / TU516	DC532	1SAP240100R0001		0.200
8 / 8 / -	24 V DC	Relay	230 V AC, 3 A (1)	TU531 / TU532	DX522	1SAP245200R0001		0.300
8 / 4 / -	230 V AC	Relay	230 V AC, 3 A (1)	TU531 / TU532	DX531	1SAP245000R0001		0.300
- / 32 / -	24 V DC	Transistor	24 V DC, 0.5 A	TU515 / TU516	DO524	1SAP240700R0001		0.200

(1) Relay outputs, changeover contacts..

Analog I/O

Number of	Input signal	Output signal	Terminal units Screw / Spring	Type	Order code	Price	Weight (1 pce) kg
AI/AO							
16 / 0	0...10 V, ±10 V	-	TU515 / TU516	AI523	1SAP250300R0001		0.200
4 / 4	0/4...20 mA, PT100, PT1000, Ni1000	±10 V	TU515 / TU516	AX521	1SAP250100R0001		0.200
8 / 8 (max. 4 current outputs)		0/4...20 mA	TU515 / TU516	AX522	1SAP250000R0001		0.200
0 / 16 (max. 8 current outputs)	-		TU515 / TU516	AO523	1SAP250200R0001		0.200
8 / 0	0...5 V, 0...10 V, ±50 mV, ±500 mV, 1 V, ±5 V, ±10 V, 0/4...20 mA, ±20 mA, PT100, PT1000, Ni1000, Cu50, 0...50 kΩ, S, T, N, K, J	-	TU515 / TU516	AI531	1SAP250600R0001		0.200

AC500

High performance modular PLC



DA501

Analog/digital mixed I/O

Standard I/O module with high functionality:

- 16 digital input channels
- 8 configurable In/Output channels
- first two inputs are also usable as high-speed counter (up to 50 kHz) together with AC500 CPU, CS31 or CI5xx communication interface modules.
- 4 independent analog input channels configurable for voltage, current, 12 bit + sign, 1-2 wire connection
- Galvanic isolation per module
- Compatible with all CI5xx modules.

Number of	Input signal	Output type	Output signal	Terminal unit	Type	Order code	Price	Weight (1 pce)
AI/AO/DI/DO/DC				Screw / Spring				kg
4 / 2 / 16 / - / 8	24 V DC/0...10 V, -10...+10 V, 0...20 mA, 4...20 mA, PT100, PT1000, Ni100, Ni1000	Transistor	24 V DC, 0.5 A / -10...+10 V, 0...20 mA, 4...20 mA	TU515 / TU516	DA501	1SAP250700R0001		0.200

4



CD522

Multifunctional modules

Functionality	Number of	Input signal	Output type	Output signal	Terminal units	Type	Order code	Price	Weight (1 pce)
	DI/DO/DC				Screw / Spring				kg
Encoder and PWM module	2 / - / 8	24 V DC and 2 encoder inputs A/B/C differential	2 PWM outputs	24 V DC, 0.1 A	TU515 / TU516	CD522	1SAP260300R0001		0.125

- DC541 occupies one communication module slot on the AC500 CPU terminal base, no terminal block required
- Usable with all CI5xx modules.

Functionality	Number of	Input signal	Output type	Output signal	Terminal unit	Type	Order code	Price	Weight (1 pce)
	DI/DO/DC								kg
Interrupt I/O and fast counter	- / - / 8	24 V DC	Transistor	24 V DC, 0.5 A	N/A (2)	DC541-CM (1)	1SAP270000R0001		0.100

(1) Multifunctional module, refer to table on page 71 for details.

(2) Occupies a communication module slot.

AC500

High performance modular PLC



CI541-DP



CI581-CN



CI511-ETHCAT



CI501-PNIO



CI504-PNIO

Communication interface modules

Number of	Input signal	Output type	Output signal	Terminal units Screw / Spring	Type	Order code	Price	Weight (1 pce) kg
AI/AO/DI/DO/DC:								
Communication interface module for CS31-Bus								
- / - / 8 / - / 16	24 V DC	Transistor	24 V DC, 0.5 A	TU551-CS31 / TU552-CS31	DC551-CS31	1SAP220500R0001		0.200
- / - / - / - / 16	24 V DC	Transistor	24 V DC, 0.5 A	TU551-CS31 / TU552-CS31	CI590-CS31-HA	1SAP221100R0001		0.200
4 / 2 / 8 / - / 8	24 V DC/ 0...10 V, -10...+10 V, 0...20 mA, 4...20 mA, PT100, PT1000, Ni100, Ni1000	Transistor	24 V DC, 0.5 A / -10...+10 V, 0...20 mA, 4...20 mA	TU551-CS31 / TU552-CS31	CI592-CS31	1SAP221200R0001		0.200
Communication interface module for PROFIBUS®-DP								
4 / 2 / 8 / 8 / -	24 V DC/ 0...10 V, -10...+10 V, 0...20 mA, 4...20 mA, PT100, PT1000, Ni100, Ni1000	Transistor	24 V DC, 0.5 A / -10...+10 V, 0...20 mA, 4...20 mA (1)	TU509/TU510/ TU517/TU518	CI541-DP	1SAP224100R0001		0.200
- / - / 8 / 8 / 8	24 V DC	Transistor	24 V DC, 0.5 A	TU509/TU510/ TU517/TU518	CI542-DP	1SAP224200R0001		0.200
Communication interface module for CANopen®								
4 / 2 / 8 / 8 / -	24 V DC/ 0...10 V, -10...+10 V, 0...20 mA, 4...20 mA, PT100, PT1000, Ni100, Ni1000	Transistor	24 V DC, 0.5 A / -10...+10 V, 0...20 mA, 4...20 mA	TU509/TU510/ TU517/TU518	CI581-CN	1SAP228100R0001		0.200
- / - / 8 / 8 / 8	24 V DC	Transistor	24 V DC, 0.5 A	TU509/TU510/ TU517/TU518	CI582-CN	1SAP228200R0001		0.200
Communication interface module for Ethernet based protocol - EtherCAT®								
4 / 2 / 8 / 8 / -	24 V DC/0...10 V, -10...+10 V, 0...20 mA, 4...20 mA, PT100, PT1000, Ni100, Ni1000	Transistor	24 V DC, 0.5 A / -10...+10 V, 0...20 mA, 4...20 mA	TU507-ETH / TU508-ETH	CI511-ETHCAT	1SAP220900R0001		0.200
- / - / 8 / 8 / 8	24 V DC	Transistor	24 V DC, 0.5 A	TU507-ETH / TU508-ETH	CI512-ETHCAT	1SAP221000R0001		0.200
Communication interface module for Ethernet based protocol - PROFINET® IO RT								
4/2/8/8/-	24 V DC/0...10 V, -10...+10 V, 0...20 mA, 4...20 mA, PT100, PT1000, Ni100, Ni1000	Transistor	24 V DC, 0.5 A / -10...+10 V, 0...20 mA, 4...20 mA	TU507-ETH / TU508-ETH	CI501-PNIO	1SAP220600R0001		0.200
- / - / 8 / 8 / 8	24 V DC	Transistor	24 V DC, 0.5 A	TU507-ETH / TU508-ETH	CI502-PNIO	1SAP220700R0001		0.200

From	To	Output signal	Terminal units	Type	Order code	Price	Weight (1 pce) kg
Communication interface module gateway on Ethernet based protocol - PROFINET® IO RT							
PROFINET® I/O	-	3 x RS232/485 ASCII serial interfaces	TU520-ETH	CI504-PNIO	1SAP221300R0001		0.200
PROFINET® I/O	1x CAN 2A/2B or CANopen® Master	2 x RS232/485 ASCII serial interfaces	TU520-ETH	CI506-PNIO	1SAP221500R0001		0.200

AC500

High performance modular PLC



TU515



TU520-ETH



TU510



TU518

Terminal units

For digital and analog expansion modules and interface modules. Please note: for modules with relay outputs, terminal units for 230 V AC (TU531 / TU532) are required.

For	Supply	Connection type	Type	Order code	Price	Weight (1 pce) kg
Ethernet interface modules	24 V DC	Screw	TU507-ETH	1SAP214200R0001		0.300
		Spring	TU508-ETH	1SAP214000R0001		0.300
Ethernet gateway modules	24 V DC	Spring	TU520-ETH	1SAP214400R0001		0.300
CANopen® / PROFIBUS® DP (1) interface modules	24 V DC	Screw	TU517	1SAP211400R0001		0.300
		Spring	TU518	1SAP211200R0001		0.300
PROFIBUS® DP / CANopen® interface modules	24 V DC	Screw	TU509	1SAP211000R0001		0.300
		Spring	TU510	1SAP210800R0001		0.300
I/O modules	24 V DC	Screw	TU515	1SAP212200R0001		0.300
		Spring	TU516	1SAP212000R0001		0.300
I/O modules AC / relay	230 V AC	Screw	TU531	1SAP217200R0001		0.300
		Spring	TU532	1SAP217000R0001		0.300
CS31 interface modules	24 V DC	Screw	TU551-CS31	1SAP210600R0001		0.300
		Spring	TU552-CS31	1SAP210400R0001		0.300

(1) TU517/TU518 Terminal units can also be used with PROFIBUS® DP CI54x modules up to 1 Mbaud.

AC500

High performance modular PLC



TU508-ETH

4

Terminal units compatibility

Type	For I/O modules		For communication interface modules				
	TU515 TU516	TU531 TU532	TU507-ETH TU508-ETH	TU509 TU510	TU517 TU518	TU520-ETH	TU551-CS31 TU552-CS31
DA501	●						
DC522	●						
DC523	●						
DC532	●						
DI524	●						
DX522		●					
DX531		●					
DO524	●						
CD522	●						
AI523	●						
AI531	●						
AO523	●						
AX521	●						
AX522	●						
DC551-CS31							●
CI590-CS31-HA							●
CI592-CS31							●
CI501-PNIO			●				
CI502-PNIO			●				
CI504-PNIO						●	
CI506-PNIO						●	
CI511-ETHCAT			●				
CI512-ETHCAT			●				
CI541-DP				●	● (1)		
CI542-DP				●	● (1)		
CI581-CN				●	●		
CI582-CN				●	●		

(1) Can be used with baud rate up to 1 Mbaud.



MC502



AC500 basic training case
CPU, I/Os, HMI

Accessories for AC500

For	Description	Type	Order code	Price	Weight (1 pce) kg
AC500 CPUs COM1	Programming cable Sub-D / terminal block, length 5 m	TK502	1SAP180200R0101		0.400
AC500 CPUs COM2	Programming cable Sub-D / Sub-D, length 5 m	TK501	1SAP180200R0001		0.400
AC500 CPUs	Memory card (2 GB SD card)	MC502	1SAP180100R0001		0.020
	Lithium battery for data buffering	TA521	1SAP180300R0001		0.100
I/O modules	Pluggable marker holder for I/O modules, packing unit incl. 10 pcs. Template available in the AC500 online help	TA523	1SAP180500R0001		0.300
AC500 CPU's, interface module, communication module and I/O modules	White labels, packaging unit incl.10 pcs.	TA525	1SAP180700R0001		0.100
Terminal base	Communication Module, blind cap	TA524	1SAP180600R0001		0.120
CPU terminal base	Accessories for wall mounting, packing unit includes 10 pcs	TA526	1SAP180800R0001		0.200
	5-pole power plug for AC500. Spare part. Can be plugged to CPU terminal base TB5x1. Packing unit includes 5 pcs	TA527	1SAP181100R0001		0.200
	9-pole COM1 plug for AC500. Spare part. Can be plugged to CPU terminal base TB5x1. Packing unit includes 5 pcs	TA528	1SAP181200R0001		0.200
AC500 basic training case CPU, I/Os, HMI	PM583-ETH + CM572 + AX561 + DC551 + CI542 + CP635 + power supply + cables + simulation stand	TA512-BAS	1SAP182400R0001		7.000
AC500 advanced training case CPU, I/Os, COM, encoder	PM583-ETH + CM574 + CM578 + CM579 + CP635 + CD522 + power supply + cables + simulation stand	TA513-ADV	1SAP182500R0001		8.800
AC500 CPUs PM595	Protective cap, spare-parts, 3 pieces	TA540	1SAP182600R0001		0.200
	Lithium battery for real-time-clock buffering	TA541	1SAP182700R0001		0.030
	Accessories for screw-mounting, 20 pieces	TA543	1SAP182800R0001		0.100

AC500

Technical data

AC500 CPUs

Type	PM572	PM573-ETH	PM582	PM583-ETH	PM590-ETH	PM591-ETH	PM591-2ETH	PM592-ETH	PM595-4ETH-F
Supply voltage	24 V DC								
Current consumption on 24 V DC									
Min. typ. (module alone)	0.050 A	0.110 A	0.050 A	0.110 A	0.150 A				0.400 A
Max. typ. (all couplers and I/Os)	0.750 A	0.810 A	0.750 A	0.810 A	0.850 A				1.2 A
User program memory – Flash EPROM and RAM	128 kB	512 kB	512 kB	1024 kB	2048 kB	4096 kB		16384 kB	
Integrated user data memory	128 kB thereof 12 kB saved	512 kB thereof 288 kB saved	416 kB thereof 288 kB saved	1024 kB thereof 288 kB saved	3072 kB thereof 536 kB saved	5632 kB thereof 1536 kB saved		16384 kB thereof 3072 kB saved	
User Flashdisk (Data-storage, programm access or also external with FTP)	–							Yes, 4 GB Flash non removable	
Plug-in memory card	Depending on SD-Card used : no SD-HC card allowed, use MC502 accessory								
Web server's data for user RAM disk	–	1 024 kB	–	4 096 kB	8 MB				32 MB
Cycle time for 1 instruction (minimum)									
Binary	0.06 µs		0.05 µs		0.002 µs				0.0006 µs
Word	0.09 µs		0.06 µs		0.004 µs				0.001 µs
Floating-point	0.7 µs		0.5 µs		0.004 µs				0.001 µs
Max. number of centralized inputs/outputs									
Max. number of extension modules on I/O bus	up to max. 10 (S500 and/or S500-eCo modules allowed)								
Digital inputs/outputs	320/320								
Analog inputs/outputs	160/160								
Max. number of decentralized inputs/outputs	depends on the used standard Fieldbus (1)								
Data buffering	battery								
Real-time clock (with battery back-up)	●								
Program execution									
Cyclical / Time controlled / Multi tasking	● / ● / ●								
User program protection by password	●								
Internal interfaces									
COM1									
RS232 / RS485 configurable	●								
Connection (on terminal bases or CPU module)	pluggable spring terminal block, use TK502 cable in accessory								
Programming, Modbus® RTU, ASCII, CS31 master	●								
COM2									
RS232 / RS485 configurable	●								
Connection (on terminal bases or CPU module)	Sub-D female 9 poles, use TK501 cable in accessory								
Programming, Modbus® RTU, ASCII	●								
FieldBusPlug									
Serial neutral interface	●								
Connection (on terminal bases)	M12 male, 5 poles								
Functions	programming cable UTF-21-FBP, slave communication depending on FieldBusPlug used (PROFIBUS® DP, CANopen®, DeviceNet)								
Ethernet									
Ethernet connection (on terminal bases)	–	RJ45	–	RJ45	RJ45	RJ45	2 x RJ45	RJ45	2 x RJ45
Ethernet functions: Programming, TCP/IP, UDP/IP, Modbus® TCP, integrated Web server, IEC60870-5-104 remote control protocol, SNTP (simple Network Time Protocol), DHCP, FTP server HTTP, SMTP, PING	–	●	–	●	●	●	●	●	●
Ethernet based Fieldbus									
Ethernet connection (on CPU module)									4 x RJ45 (2 x interfaces with 2-port switch)
Downloadable protocols like: PROFINET® IO RT Controller / Device (2) EtherCAT® (2) Master / Slave									●
LCD display									
Function	LCD display and 8 function keys RUN / STOP, status, diagnosis								RUN / STOP, status, diagnosis, RESET
LEDs for various status display	–								●
Timer/Counter	unlimited/unlimited								
Approvals	See detailed page 168 or www.abb.com/plc								

(1) e.g. CS31 Fieldbus: up to 31 stations with up to 120 DIs / 120 DOs or up to 32 AIs / 32 AOs per station.

(2) Availability on demand

AC500

Technical data

Digital S500 I/O modules

Type	DI524	DC522	DC523	DC532
Number of channels per module				
Digital inputs	32	–	–	16
Digital outputs	–	–	–	–
Configurable channels DC (configurable as inputs or outputs)	–	16	24	16
Additional configuration of channels as				
Fast counter	configuration of max. 2 channels per module, operating modes see table on 81			
Occupies max. 1 DO or DC when used as counter	–	●	●	●
Connection via terminal unit	●	●	●	●
Digital inputs				
Input signal voltage	24 V DC			
Input characteristic acc. to EN 61132-2	Type 1			
0 signal	–3...+5 V DC			
Undefined signal state	5...15 V DC			
1 signal	15...30 V DC			
Input time delay (0 → 1 or 1 → 0)	8 ms typically, configurable from 0.1 up to 32 ms			
Input current per channel				
At input voltage	24 V DC	5 mA typically		
	5 V DC	> 1 mA		
	15 V DC	> 5 mA		
	30 V DC	< 8 mA		
Digital outputs				
Transistor outputs 24 V DC, 0.5 A	–	●	●	●
Readback of output	–	●	●	●
Switching of load 24 V	–	●	●	●
Output voltage at signal state 1	–	process voltage UP minus 0.8 V		
Output current				
Nominal current per channel	–	500 mA at UP = 24 V		
Maximum (total current of all channels)	–	8 A		
Residual current at signal state 0	–	< 0.5 mA		
Demagnetization when switching off inductive loads	–	by internal varistors		
Switching frequency				
For inductive load	–	0.5 Hz max.		
For lamp load	–	11 Hz max. at max. 5 W		
Short-circuit / overload proofness	–	●	●	●
Overload indication (I > 0.7 A)	–	after approx. 100 ms		
Output current limiting	–	yes, with automatic reclosure		
Proofness against reverse feeding of 24 V signals	–	●	●	●
Process voltage UP				
Nominal voltage	24 V DC			
Maximum ripple	5 %			
Current consumption on UP				
Min. typ. (module alone)	0.150 A	0.100 A	0.150 A	
Max. typ. (min. + loads)	0.150 A	0.100 A + load	0.150 A + load	
Reverse polarity protection	●	●	●	●
Fuse for process voltage UP	10 A miniature fuse			
Connections for sensor voltage supply. Terminal 24 V and 0 V for each connection. Permitted load for each group of 4 or 8 connections: 0.5 A	–	8	4	–
Short-circuit and overload proof 24 VDC sensor supply voltage	–	●	●	–

AC500

Technical data

Digital S500 I/O modules

Type		DI524	DC522	DC523	DC532
Maximum cable length for connected process signals					
Cable	shielded	1000 m			
	unshielded	600 m			
Potential isolation					
Per module		●	●	●	●
Between channels	input	-	-	-	-
	output	-	-	-	-
Voltage supply for the module		internally via extension bus interface (I/O bus)			
Fieldbus connection		via AC500 CPU or all communication interface modules			
Address setting		automatically (internal)			

AC500

Technical data

Digital S500 I/O modules

Type	DX522		DX531	DO524
Number of channels per module				
Digital inputs	8		8 relays	4 relays
Digital outputs	-		8 relays	32
Configurable channels DC (configurable as inputs or outputs)	-		-	-
Additional configuration of channels as				
Fast counter	configuration of max. 2 channels per module, operating modes see page 83		-	-
Occupies max. 1 DO or DC when used as counter	-		-	-
Connection via terminal unit	●		●	●
Digital inputs				
Input signal voltage	24 V DC		230 V AC or 120 V AC	-
Frequency range	-		47...63 Hz	-
Input characteristic acc. to EN 61132-2	Type 1		Type 2	-
0 signal	-3...+5 V DC		0...40 V AC	-
Undefined signal state	5...15 V DC		> 40 V AC...< 74 V AC	-
1 signal	15...30 V DC		74...265 V AC	-
Input time delay (0 -> 1 or 1 -> 0)	8 ms typically, configurable from 0.1 up to 32 ms		20 ms typically	-
Input current per channel				
At input voltage	24 V DC	5 mA typically	-	-
	5 V DC	> 1 mA	-	-
	15 V DC	> 5 mA	-	-
	30 V DC	< 8 mA	-	-
	159 V AC	-	> 7 mA	-
	40 V AC	-	< 5 mA	-
Digital outputs				
Transistor outputs 24 V DC, 0.5 A	-		-	●
Readback output	-		-	-
Relay outputs, supplied via process voltage UP, changeover contacts	●		●	-
Switching of load	24 V	●	●	●
	230 V	●	●	-
Output voltage at signal state 1	-		-	process voltage UP minus 0.8 V
Output current				
Nominal current per channel	-		-	500 mA at UP = 24 V
Maximum (total current of all channels)	-		-	8 A
Residual current at signal state 0	-		-	< 0.5 mA
Demagnetization when switching off inductive loads	-		-	by internal varistors
Switching frequency				
For inductive load	2 Hz		-	0.5 Hz max.
For lamp load	11 Hz max. at max. 5 W		-	-
Short-circuit / overload proofness	by external fuse / circuit breaker. 6 A gL/gG per channel		-	●
Overload indication (I > 0.7 A)	-		-	after approx. 100 ms
Output current limiting	-		-	yes, with automatic reclosure
Proofness against reverse feeding of 24 V signals	-		-	●
Contact rating				
For resistive load, max.	3 A at 230 V AC 2 A at 24 V DC		-	-
For inductive load, max.	1.5 A at 230 V AC 1.5 A at 24 V DC		-	-
For lamp load	60 W at 230 V AC 10 W at 24 V DC		-	-

AC500

Technical data

Digital S500 I/O modules

Type	DX522		DX531	DO524
Lifetime (switching cycles)				
Mechanical lifetime	300 000			-
Lifetime under load	300 000 at 24 V DC / 2 A 200 000 at 120 V AC / 2 A 100 000 at 230 V AC / 3 A			-
Spark suppression for inductive AC load	external measure depending on the switched load			-
Demagnetization for inductive DC load	external measure: free-wheeling diode connected in parallel to the load			-
Process voltage UP				
Nominal voltage	24 V DC			
Maximum ripple	5 %			
Current consumption on UP				
Min. typ. (module alone)	0.050 A	0.150 A		0.050 A
Max. typ. (min. + loads)	0.050 A + load	0.150 A + load		0.100 + load
Reverse polarity protection	●	●		●
Fuse for process voltage UP	10 A miniature fuse			
Maximum cable length for connected process signals				
Cable	shielded	1000 m		
	unshielded	600 m		
Potential isolation				
Per module		●		●
Between the channels	input	-	● (per 2)	-
	output	●	●	-
Voltage supply for the module	internally via extension bus interface (I/O bus)			
Fieldbus connection	via AC500 CPU or all communication interface modules			
Address setting	automatically (internal)			

AC500

Technical data

Analog S500 I/O modules

Type		AX521	AX522	AI523	AO523	AI531
Number of channels per module						
Individual configuration, analog	inputs	4	8	16	–	8
	outputs	4	8	–	16	–

Signal resolution for channel configuration

-10...+10 V	12 bits + sign					15 bits + sign
0...10 V	12 bits					15 bits
0...20 mA, 4...20 mA	12 bits					15 bits
Temperature: 0.1 °C	●	●	●	●	●	●

Monitoring configuration per channel

Plausibility monitoring	●	●	●	●	●	●
Wire break & short-circuit monitoring	●	●	●	●	●	●

Analog Inputs AI

Signal configuration per AI	max. number per module and with regard to the configuration: AIs / Measuring points (depending on the use of 2/3-wire connection or differential input)					
0...10 V	4 / 4	8 / 8	16 / 16	–	–	8 / 8
-10...+10 V	4 / 4	8 / 8	16 / 16	–	–	8 / 8
0...20 mA	4 / 4	8 / 8	16 / 16	–	–	8 / 8
4...20 mA	4 / 4	8 / 8	16 / 16	–	–	8 / 8
Pt100						
-50...+400 °C (2-wire)	4 / 4	8 / 8	16 / 16	–	–	8 / 8
-50...+400 °C (3-wire), 2 channels	4 / 2	8 / 4	16 / 8	–	–	8 / 8
-50...+400 °C (4-wire)	–	–	–	–	–	8 / 8
-50...+70 °C (2-wire)	4 / 4	8 / 8	16 / 16	–	–	8 / 8
-50...+70 °C (3-wire), 2 channels	4 / 2	8 / 4	16 / 8	–	–	8 / 8
-50...+70 °C (4-wire)	–	–	–	–	–	8 / 8
Pt1000						
-50...+400 °C (2-wire)	4 / 4	8 / 8	16 / 16	–	–	8 / 8
-50...+400 °C (3-wire), 2 channels	4 / 2	8 / 4	16 / 8	–	–	8 / 8
-50...+400 °C (4-wire)	–	–	–	–	–	8 / 8
Ni1000						
-50...+150 °C (2-wire)	4 / 4	8 / 8	16 / 16	–	–	8 / 8
-50...+150 °C (3-wire), 2 channels	4 / 2	8 / 4	16 / 8	–	–	8 / 8
-50...+150 °C (4-wire)	–	–	–	–	–	8 / 8
Thermocouples of types J, K, T, N, S	–	–	–	–	–	●
0...10 V using differential inputs, 2 channels	4 / 2	8 / 4	16 / 8	–	–	8 / 8
-10...+10 V using differential inputs, 2 channels	4 / 2	8 / 4	16 / 8	–	–	8 / 8
Digital signals (digital input)	4 / 4	8 / 8	16 / 16	–	–	8 / 8
Input resistance per channel	voltage: > 100 kΩ current: approx. 330 Ω			–	–	voltage: > 100 kΩ current: approx. 330 Ω
Time constant of the input filter	voltage: 100 μs current: 100 μs			–	–	voltage: 100 μs current: 100 μs
Conversion cycle	2 ms (for 8 AI + 8 AO), 1 s for Pt100/1000, Ni1000			–	–	1 ms (for 8 AI + 8 AO), 1 s for Pt100/1000, Ni1000
Overvoltage protection	●	●	●	–	–	●

Data when using the AI as digital input

Input	time delay	8 ms typically, configurable from 0.1 up to 32 ms	–	–	8 ms typically, configurable from 0.1 up to 32 ms
	signal voltage	24 V DC	–	–	24 V DC
Signal	0	-30...+5 V	–	–	-30...+5 V
	1	13...30 V	–	–	13...30 V

Analog outputs AO

Possible configuration per AO	Max. number of AOs per module and with regard to the configuration:					
-10...+10 V	4	8 (1)	–	–	16 (1)	–
0...20 mA	4	–	–	–	8	–
4...20 mA	4	–	–	–	8	–
Output	resistance (burden) when used as current output	0...500 Ω	–	–	0...500 Ω	–
	loading capability when used as voltage output	Max. ±10 mA	–	–	Max. ±10 mA	–

(1) Half can be used on current (the other half remains available).

AC500

Technical data

Analog S500 I/O modules

Type	AX521	AX522	AI523	AO523	AI531
Process voltage UP					
Nominal voltage	24 V DC				
Maximum ripple	5 %				
Current consumption on UP					
Min. typ. (module alone)	0.150 A				0.130 A
Max. typ. (min. + loads)	0.150 A + load	0.150 A + load	-	0.150 A + load	
Reverse polarity protection	●	●	●	●	●
Max. line length of the analog lines, conductor cross section > 0.14 mm ²	100 m				
Conversion error of analog values caused by non-linearity, calibration errors ex works and the resolution in the nominal range	0.5 % typically, 1 % max.				
Potential isolation					
Per module	●	●	●	●	-
Fieldbus connection	Via AC500 CPU or all communication interface modules				
Voltage supply for the module	Internally via extension bus interface (I/O bus)				-

AC500

Technical data

CD522 encoder module

The CD522 module offers accuracy and dynamic flexibility for a customized solution. It has two independent encoder inputs onboard and is easily configured using the Automation Builder software for 10 different operation modes and for frequencies up to 300 kHz (depending on CPU cycle time). The CD522 module also integrates outputs for pulses and for PWM as well as normal inputs and outputs, depending on selected encoder mode.

Type		CD522
Functionality		
Digital inputs/outputs		24 V DC, dedicated inputs/outputs can be used for specific counting functions. All unused inputs/outputs can be used as input/output with standard specification.
	Input options	Catch/Touch operation, counter value stored in separate variable on external event (rising or falling) Set to preset counter register with predefined value Set to reset counter register
	End value output	Output set when predefined value is reached
	Reference point initialization (RPI) input for relative encoder initialization	●
High-speed counter/encoder Integrated counters		
	Counter characteristics	2 counters (24 V DC, 5 V DC, differential and 1 V _{pp} sinus input)
	Counter mode	one 32 bits or two 16 bits
	Relative position encoder	X1, X2, X3
	Absolute SSI encoder	●
	Time frequency meter	●
	Frequency input	up to 300 kHz
PWM/pulse outputs		
Output mode specification		
	Number of outputs	2
	Push pull output	24 V DC, 100 mA max
	Current limitation	Thermal and overcurrent
PWM mode specification		
	Frequency	1...100 kHz
	Value	0...100 %
Pulse mode specification		
	Frequency	1...15 kHz
	Pulse emission	1...65535 pulses
	Number of pulses emitted indicator	0...100 %
Frequency mode specification		
	Frequency output	100 kHz
	Duty Cycle	Set to 50 %
Number of channels per module		
Digital	input	2
	output	2
Configurable channels DC (configurable as inputs or outputs)		8
Additional configuration of channels as		
Fast counter		Integrated 2 counter encoders
Connection via terminal unit		●
Digital Inputs		
Input	signal voltage	24 V DC
	time delay	8 ms typically configurable from 0.1 up to 32 ms
Input current per channel		
At input voltage	24 V DC	Typically 5 mA
	5 V DC	> 1 mA
	15 V DC	> 5 mA
	30 V DC	< 8 mA
Digital outputs		
Output voltage at signal state 1		UP – 0.8 V
Output current		
Nominal current per channel		0.5 A at UP = 24 V
Maximum (total current of all channels)		8 A
Residual current at signal state 0		< 0.5 mA
Demagnetization when switching off inductive loads		By internal varistors
Switching frequency		
For inductive load		Max. 0.5 Hz
For lamp load		Max. 11 Hz with max. 5 W
Short-circuit / Overload proofness		●
Overload indication (I > 0.7 A)		After approx. 100 ms
Output current limiting		●
Proofness against reverse feeding of 24 V signals		●

AC500

Technical data

CD522 encoder module

Type	CD522	
Maximum cable length for connected process signals		
Cable	shielded	1000 m
	unshielded	600 m
Potential isolation		
Per module	●	
Technical data of the high-speed inputs		
Number of channels per module	6	
Input type	24 V DC, 5 V DC / Differential / Sinus 1 Vpp	
Frequency	300 kHz	
Technical data of the fast outputs		
Number of channels	2	
Indication of the output signals	Brightness of the LED depends on the number of pulses emitted (0 % to 100 %) (pulse output mode only)	
Output current		
Rated value, per channel	100 mA at UP = 24 V	
Maximum value (all channels together, configurable outputs included)	8 A	
Leakage current with signal 0	< 0.5 mA	
Rated protection fuse on UP	10 A fast	
De-magnetization when inductive loads are switched off	with varistors integrated in the module	
Overload message ($I > 0.1 \times A$)	Yes, after ca. 100 ms	
Output current limitation	Yes, automatic reactivation after short-circuit/overload	
Resistance to feedback against 24 V signals	Yes	
Process voltage UP		
Nominal voltage	24 V DC	
Maximum ripple	5 %	
Current consumption on UP		
Min. typ. (module alone)	0.070 A	
Max. typ. (min. + loads)	0.070 A + load	
Reverse polarity protection	●	
Fuse for process voltage UP	10 A miniature fuse	

AC500

Technical data

Analog/digital mixed I/O expansion module

For all modules: max cable length for connected process signals is 1000 m for shielded cable and 600 m for unshielded ones.
For all Input modules, the signal resolution for channel configuration is: -10...+10 V: 12 bit + sign; 0...10 V, 0...20 mA, 4...20 mA: 12 bits.

Type		DA501
Number of Channels per Module		
Digital	inputs	16
	outputs	–
Analog	inputs	4
	outputs	2
Digital configurable channels DC (configurable as inputs or outputs)		8
Additional configuration of channels as		
Fast counter		Yes
Occupies max. 1 DO or DC when used as counter		Configuration of max. 2 channels per module. Operating modes see table on page 83
Connection via terminal unit TU 5xx		●
Digital inputs		
Input	signal voltage	24 V DC
	characteristic acc. to EN 61132-2	Type 1
0 signal		-3...+5 V DC
Undefined signal state		5...15 V DC
1 signal		15...30 V DC
Residual ripple, range for	0 signal	-3...+5 V DC
	1 signal	15...30 V DC
Input time delay (0 -> 1 or 1 -> 0)		8 ms typically, configurable from 0.1 up to 32 ms
Digital outputs		
Transistor outputs 24 V DC, 0.5 A		●
Readback of output		●
Outputs, supplied via process voltage UP		●
Switching of 24 V load		●
Output voltage at signal state 1		Process voltage UP - 0.8 V
Output current		
Nominal current per channel		500 mA at UP = 24 V DC
Maximum (total current of all channels)		8 A
Residual current at signal state 0		< 0.5 mA
Demagnetization when switching off inductive loads		By internal varistors
Analog inputs AI		
Signal configuration per AI		●
0...10 V / -10...+10 V		4 / 4
0...20 mA / 4...20 mA		4 / 4
RTD using 2/3 wire needs 1/2 channel(s)		4 / 2
0...10 V using differential inputs, needs 2 channels		4 / 2
-10...+10 V using differential inputs, needs 2 channels		4 / 2
Digital signals (digital input)		4 / 4
Data when using the AI as digital input		
Input	time delay	8 ms typically, configurable from 0.1 up to 32 ms
	signal voltage	24 V DC
Outputs, single configurable as		
Possible configuration per AO		●
-10...+10 V		●
0...20 mA / 4...20 mA		●
Output resistance (load) when used as current output		0...500 Ω
Output loading capability when used as voltage output		±10 mA max.
Potential isolation		
Per module		●
Process voltage UP		
Nominal voltage		24 V DC
Maximum ripple		5 %
Current consumption on UP		
Min. typ. (module alone)		0.070 A
Max. typ. (min. + loads)		0.070 A + load
Reverse polarity protection		●
Fuse for process voltage UP		10 A miniature fuse
Approvals		See detailed page 168 or www.abb.com/plc

AC500

Technical data

DC541-CM interrupt I/O and fast counter module

In the operating mode counter, the channels can be configured as follows:

Input, Output, 32-bit up/down counter (uses C0...C3) as a 32-bit counter without limit, 32-bit periodic counter as a 32-bit counter with a limit, limiter for a 32-bit counter (limit channel 0), 32-bit up counter (forward counter) with the frequencies 50 kHz, 5 kHz and 2.5 kHz, pulse-width modulation (PWM) with a resolution of 10 kHz, time and frequency measurement, frequency output.

Type	DC541-CM	
Number of channels per module		
Configurable channels DC (configurable as inputs or outputs)	8	
Additional configuration of channels as		
Fast counter	Yes	
Connection via CPU terminal base. Occupies one communication module slot	●	
Digital inputs		
Input signal voltage	24 V DC	
characteristic acc. to EN 61132-2	Type 1	
0 signal	-3...+5 V DC	
Undefined signal state	5...15 V DC	
1 signal	5...30 V DC	
Input time delay (0 -> 1 or 1 -> 0)	20 µs	
	Clamp to clamp - 300 µs with interrupt task	
Input current per channel		
At input voltage	24 V DC	5 mA typically
	5 V DC	> 1 mA
	15 V DC	> 5 mA
	30 V DC	< 8 mA
Digital outputs		
Transistor outputs 24 V DC, 0.5 A	●	
Readback of output	●	
Switching of 24 V load	●	
Output voltage at signal state 1	Process voltage UP minus 0.8 V	
Output current		
Nominal current per channel	500 mA at UP = 24 V	
Maximum (total current of all channels)	8 A	
Residual current at signal state 0	< 0.5 mA	
Demagnetization when switching off inductive loads	by internal varistors	
Potential isolation		
Per module	●	
Voltage supply for the module	Internally via backplane bus	

Interrupt I/O table

Configuration as	Configuration for channel no.					Max. no. of channels for this function	Remarks and notes regarding possible alternative combinations of the remaining channels (a and b)	
	Chan. 0	Chan. 1	Chan. 2	Chan. 3	Chan. 4-7			
Mode 1: Interrupt functionality								
Interrupt	Digital input	1	1	1	1	4	8	Each channel can be configured individually as interrupt input or output
	Digital output	1	1	1	1	4	8	
Mode 2: Counting functionality								
Digital I/Os PWM (1)	Digital input	1	1	1	1	4	8	Usual input
	Digital output	1	1	1	1	4	8	Usual output
	PWM, resolution 10 kHz	1	1	1	1	4	8	Outputs and pulsed signal with and adjustable on-off ratio

(1) Counter and fast counter data available on technical documentation.

AC500

Technical data

AC500 communication modules

- Up to 4 communications modules can be used on an AC500 CPU
- No external power supply required.

Type	CM572-DP	CM597-ETH	CM578-CN	CM588-CN	CM579-PNIO	CM589-PNIO	CM579-ETHCAT	CM574-RS	CM574-RCOM
Communication interfaces									
RJ45	–	● (x 2) (2)	–	–	● (x 2) (2)	● (x 2) (2)	● (x 2)	–	–
RS-232 / 485	–	–	–	–	–	–	–	● (x 2)	● (x 2)
Terminal blocks (1)	–	–	●	●	–	–	–	● (x 2)	● (x 2)
Sub-D socket	●	–	–	–	–	–	–	–	–
Protocols	PROFIBUS® DP Master V0/V1	Ethernet (TCP/IP, UDP/IP, Modbus® TCP)	CANopen® master	CANopen® slave	PROFINET® IO Controller	PROFINET® IO Device	EtherCAT®	Serial COM ASCII, Modbus® RTU, CS31	Serial RCOM/RCOM+
CPU interface	8 kB Dual-port memory	8 kB Dual-port memory	8 kB Dual-port memory	8 kB Dual-port memory	8 kB Dual-port memory	8 kB Dual-port memory	8 kB Dual-port memory	8 kB Dual-port memory	8 kB Dual-port memory
Transfer Rate	9.6 kbit/s to 12 Mbit/s	10 / 100 Mbit/s	10 kbit/s to 1 Mbit/s	10 kbit/s to 1 Mbit/s	10 / 100 Mbit/s	10 / 100 Mbit/s	10 / 100 Mbit/s	9.6 kBit/s up to 187.5 kBit/s	2.4 kBit/s to 19.2 kBit/s
Co-processor	Communication processor	Communication processor netX 100	Communication processor	Communication processor netX 100	Communication processor netX 100	Communication processor netX 100	Communication processor netX 100	Programmable CPU like PM57x with PowerPC 50 MHz processor	PowerPC 50 MHz processor
Memory	–	–	–	–	–	–	–	256 kB program memory 384 kB data memory	–
Additional features	Multi master functionality Max. Number of subscribers: – 126 (V0) – 32 (V1)	BOOTP DHCP	CAN 2.0A CAN 2.0B CANopen®	NMT Slave PDO SDO server Heartbeat Nodeguard	RTC - Real-time Cyclic Protocol, Class 1 RTA - Real-time Acyclic Protocol DCP Discovery and Configuration Protocol CL-RPC - Connectionless Remote Procedure Call	RTC - Real-time Cyclic Protocol, Class 1 RTA - Real-time Acyclic protocol DCP Discovery and Configuration Protocol LLDP - Link Layer Discovery Protocol	CoE (Can over Ethercat) process data (PDO) (cyclic) CoE Mailbox data (SDO) (acyclic) Distributed Clock (32-bit, 64-bit)	– Stand alone CPU in coupler module housing allowing to be used as standard serial interface or as free programmable serial interface coupler. – Independant internal CPU programmable for own communication protocol or data processing. – 2 x CS31 master, Modbus® master/slave, free configurable, protocols ASCII.	–

(1) Plug-in terminal block included.

(2) 10 / 100 Mbit/s, full/half duplex with auto-sensing, 2-port switch integrated.

AC500

Technical data

Communication interface modules

For all modules: max cable length for connected process signals is 1000 m for shielded cable and 600 m for unshielded ones.
For all Input modules, the signal resolution for channel configuration is: -10...+10 V: 12 bits + sign; 0...10 V, 0...20 mA, 4...20 mA: 12 bits.
Temperature: 0.1 °C.

Type	DC551-CS31	CI590-CS31-HA (1)	CI592-CS31
Communication Interface			
Protocol	Proprietary CS31 bus protocol on RS485 interface		
ID configuration	Per rotary switches on front face from 00d to 99d		
Field bus connection on terminal units	CS31 field bus, via terminal / redundant for CI590-CS31-HA on TU551-CS31 or TU552-CS31		
Number of Channels per Module			
Digital	inputs	8	8
	outputs	–	–
Analog	inputs	–	4
	outputs	–	2
Digital configurable channels DC (configurable as inputs or outputs)		16	8
Additional configuration of channels as			
Fast counter	Configuration of max. 2 channels per module		
Occupies max. 1 DO or DC when used as counter	●	●	●
Connection			
Via terminal unit TU5xx	●	●	●
Local I/O extension			
Max. number of extension modules	max. 7 x S500 extension modules (standard or eCo), up to 31 stations with up to 120 DI/120 DOs or up to 32 AIs/32AOs per station		
		not for S500-eCo I/O modules	
Digital inputs			
Input	signal voltage	24 V DC	
	characteristic acc. to EN 61132-2	Type 1	
0 signal		-3...+5 V DC	
Undefined signal state		5...15 V DC	
1 signal		15...30 V DC	
Residual ripple, range for	0 signal	-3...+5 V DC	
	1 signal	15...30 V DC	
Input time delay (0 -> 1 or 1 -> 0)		8 ms typically, configurable from 0.1 up to 32 ms	
Digital outputs			
Transistor outputs 24 V DC, 0.5 A	●		
Readback of output	●		
Outputs, supplied via process voltage UP	●		
Switching of 24 V load	●		
Output voltage at signal state 1	Process voltage UP - 0.8 V		
Output current			
Nominal current per channel	500 mA at UP = 24 V DC		
Maximum (total current of all channels)	8 A	8 A	4 A
Residual current at signal state 0	< 0.5 mA		
Demagnetization when switching off inductive loads	By internal varistors		
Analog inputs AI			
Signal configuration per AI	Max. number per module and with regard to the configuration: AIs / Measuring points		
0...10 V / -10...+10 V	–		●
0...20 mA / 4...20 mA	–		4 / 4
RTD using 2/3 wire needs 1/2 channel(s)	–		4 / 2
0...10 V using differential inputs, needs 2 channels	–		4 / 2
-10...+10 V using differential inputs, needs 2 channels	–		4 / 2
Digital signals (digital input)	–		4 / 4
Data when using the AI as digital input			
Input	time delay	–	8 ms typically, configurable from 0.1 up to 32 ms
	signal voltage	–	24 V DC

(1) Dedicated to High Availability.

AC500

Technical data

Communication interface modules

Type	DC551-CS31	CI590-CS31-HA (1)	CI592-CS31
Outputs, single configurable as			
Possible configuration per AO	-		●
-10...+10 V	-		●
0...20 mA / 4...20 mA	-		●
Output	resistance (load) when used as current output	-	0...500 Ω
	loading capability when used as voltage output	-	±10 mA max.
Potential isolation			
Per module	●	●	●
Between fieldbus interface against the rest of the module	●	●	●
Voltage supply for the module	By external 24 V DC voltage via terminal UP		
Process voltage UP			
Nominal voltage	24 V DC		
Maximum ripple	5 %		
Current consumption on UP			
Min. typ. (module alone)	0.100 A	0.100 A	0.070 A
Max. typ. (min. + loads)	0.100 A + load	0.100 A + load	0.070 A + load
Reverse polarity protection	●		
Fuse for process voltage UP	10 A miniature fuse		
Approvals	See detailed page 168 or www.abb.com/plc		

(1) Dedicated to High Availability.

AC500

Technical data

PROFIBUS®-DP modules

Type	CI541-DP	CI542-DP	
Communication Interface			
Protocol	PROFIBUS® DP (DP-V0 and DP-V1 slave)		
ID configuration	Per rotary switches on front face from 00h to FFh		
Field bus connection on terminal units	Sub-D 9 poles on TU509, TU510 preferred but TU517/TU518 can be used with baud rate up to 1Mbaud		
Number of Channels per Module			
Digital	inputs	8	8
	outputs	8	8
Analog	inputs	4	-
	outputs	2	-
Digital configurable channels DC (configurable as inputs or outputs)		-	8
Additional configuration of channels as			
Fast counter (onboard I/O)	Configuration of max. 2 DI channels per module		
Occupies max 1 DO or DC when used as counter	●		
Connection			
Local I/O extension	●		
Max. number of extension modules	max. 10 x S500 extension modules (standard or eCo modules allowed). Fast counter from digital IO modules can be also used.		
Via terminal unit TU5xx	●		
Digital inputs			
Input	signal voltage	24 V DC	
	characteristic acc. to EN 61132-2	Type 1	
0 signal		-3...+5 V DC	
Undefined signal state		5...15 V DC	
1 signal		15...30 V DC	
Residual ripple, range for	0 signal	-3...+5 V DC	
	1 signal	15...30 V DC	
Input time delay (0 -> 1 or 1 -> 0)		8 ms typically, configurable from 0.1 up to 32 ms	
Digital outputs			
Transistor outputs 24 V DC, 0.5 A	●		
Readback of output	-	● (on DC outputs)	
Outputs, supplied via process voltage UP	●		
Switching of 24 V load	●		
Output voltage at signal state 1	Process voltage UP - 0.8 V		
Output current			
Nominal current per channel	500 mA at UP = 24 V DC		
Maximum (total current of all channels)	8 A		
Residual current at signal state 0	< 0.5 mA		
Demagnetization when switching off inductive loads	By internal varistors		
Analog Inputs AI			
	Max. number per module and with regard to the configuration: AIs / Measuring points		
Signal configuration per AI	4	-	
0...10 V / -10...+10 V	4 / 4	-	
0...20 mA / 4...20 mA	4 / 4	-	
RTD using 2/3 wire needs 1/2 channel(s)	4 / 2	-	
0...10 V using differential inputs, needs 2 channels	4 / 2	-	
-10...+10 V using differential inputs, needs 2 channels	4 / 2	-	
Digital signals (digital input)	4 / 4	-	
Data when using the AI as digital input			
Input	input time delay	8 ms typically, configurable from 0.1 up to 32 ms	-
	signal voltage	24 V DC	-
Outputs, single configurable as			
Possible configuration per AO	●	-	
-10...+10V	●	-	
0...20 mA / 4...20 mA	●	-	
Output	resistance (load) when used as current output	0...500 Ω	-
	loading capability when used as voltage output	±10 mA max.	-

AC500

Technical data

PROFIBUS®-DP modules

Type	CI541-DP	CI542-DP
Potential isolation		
Per module	●	●
Between fieldbus interface against the rest of the module	●	●
Between the channels	-	-
input	-	-
output	-	-
Voltage supply for the module	By external 24 V DC voltage via terminal UP	
Process voltage UP		
Nominal voltage	24 V DC	
Maximum ripple	5 %	
Current consumption on UP		
Min. typ. (module alone)	0.260 A	
Max. typ. (min. + loads)	0.260 A + load	
Reverse polarity protection	●	
Fuse for process voltage UP	10 A miniature fuse	
Approvals	See detailed page 168 or www.abb.com/plc	

4

AC500

Technical data

CANopen® modules

Type	CI581-CN	CI582-CN	
Communication interface			
Protocol	CANopen® slave, DS401 profile selectable using rotary switches		
ID configuration	Per rotary switches on front face for CANopen® ID node from 00h to 7Fh and 80h to FFh for CANopen® DS401 profile		
Field bus connection on terminal units	Terminal blocks on TU517/TU518 or TU509/TU510		
Number of channels per module			
Digital	inputs	8	8
	outputs	8	8
Analog	inputs	4	-
	outputs	2	-
Digital configurable channels DC (configurable as inputs or outputs)		-	8
Additional configuration of channels as			
Fast counter (onboard I/O)	Configuration of max. 2 DI channels per module		
Occupies max. 1 DO or DC when used as counter	●	●	
Connection			
Local I/O extension	●		
Max. number of extension modules	max. 10 x S500 extension modules (standard or eCo modules are allowed)		
Via terminal unit TU5xx	●	●	
Digital inputs			
Input	signal voltage characteristic acc. to EN 61132-2	24 V DC Type 1	
0 signal		-3...+5 V DC	
Undefined signal state		5...15 V DC	
1 signal		15...30 V DC	
Residual ripple, range for	0 signal	-3...+5 V DC	
	1 signal	15...30 V DC	
Input time delay (0 -> 1 or 1 -> 0)	8 ms typically, configurable from 0.1 up to 32 ms		
Digital outputs			
Transistor outputs 24 V DC, 0.5 A	●		
Readback of output	-	● (on DC outputs)	
Outputs, supplied via process voltage UP	●		
Switching of 24 V load	●		
Output voltage at signal state 1	Process voltage UP - 0.8 V		
Output current			
Nominal current per channel	500 mA at UP = 24 V DC		
Maximum (total current of all channels)	8 A		
Residual current at signal state 0	< 0.5 mA		
Demagnetization when switching off inductive loads	By internal varistors		
Analog Inputs AI			
Signal configuration per AI	Max. number per module and with regard to the configuration: AIs / Measuring points		
0...10 V / -10...+10 V	4 / 4	-	
0...20 mA / 4...20 mA	4 / 4	-	
RTD using 2/3 wire needs 1/2 channel(s)	4 / 2	-	
0...10 V using differential inputs, needs 2 channels	4 / 2	-	
-10...+10 V using differential inputs, needs 2 channels	4 / 2	-	
Digital signals (digital input)	4 / 4	-	
Data when using the AI as digital input			
Input	time delay	8 ms typically, configurable from 0.1 up to 32 ms	-
	signal voltage	24 V DC	-
Outputs, single configurable as			
Possible configuration per AO	●		-
-10...+10 V	●		-
0...20 mA / 4...20 mA	●		-
Output	resistance (load) when used as current output	0...500 Ω	-
	loading capability when used as voltage output	±10 mA max.	-

AC500

Technical data

CANopen® modules

Type	CI581-CN	CI582-CN
Potential isolation		
Per module	●	●
Between fieldbus interface against the rest of the module	●	●
Between the channels	-	-
input	-	-
output	-	-
Voltage supply for the module	By external 24 V DC voltage via terminal UP	
Process voltage UP		
Nominal voltage	24 V DC	
Maximum ripple	5 %	
Current consumption on UP		
Min. typ. (module alone)	0.260 A	
Max. typ. (min. + loads)	0.260 A + load	
Reverse polarity protection	●	
Fuse for process voltage UP	10 A miniature fuse	
Approvals	See detailed page 168 or www.abb.com/plc	

4

AC500

Technical data

PROFINET® IO RT device modules

Type	CI501-PNIO	CI502-PNIO	CI504-PNIO	CI506-PNIO
Communication interface				
Ethernet Interface				
Main protocol	PROFINET® IO RT device			
ID Device configuration	By rotary switch on the front side, from 00h to FFh			
Ethernet connection on terminal units	2 x RJ45 with switch functionality for simple daisy chain on TU507-ETH or TU508-ETH or TU520-ETH			
Gateway Interface				
Gateway to	-	-	3 x RS232 / RS422 / RS485 ASCII serial interfaces	CAN / CANopen® Master + 2 x RS232 / RS422 / RS485 ASCII serial interfaces
Fieldbus Protocol used				
CAN physical interface	-	-	-	CAN 2A/2B Master - CANopen® Master (1) 1 x 10 poles pluggable spring connector
Baudrate	-	-	-	Baudrate up to 1 MBit/s, Support for up to 126 CANopen® Slaves
Serial interface				
Protocol used	-	-	3 x RS232 / RS422 or RS485	2 x RS232 / RS422 or RS485
Baudrate	-	-	ASCII	ASCII
Fieldbus or serial connection on terminal units	-	-	Configurable from 300 bit/s to 115200 bit/s	3 x pluggable terminal blocks with spring on TU520-ETH
Number of channels per module				
Digital	inputs	8	8	-
	outputs	8	8	-
Analog	inputs	4	-	-
	outputs	2	-	-
Digital configurable channels DC (configurable as inputs or outputs)		-	8	-
Additional configuration of channels as				
Fast counter (onboard I/O)	Configuration of max. 2 DI channels per module		-	-
Occupies max. 1 DO or DC when used as counter	●		-	-
Connection				
Local I/O extension	●		●	●
Max. number of extension modules	max. 10 x S500 extension modules (standard or eCo modules allowed). Fast counter from digital IO modules can be also used.		Valid for CI501, 502, 504 and 506. All modules can have extension up to 10 modules	
Via terminal unit TU5xx	●		●	●
Digital inputs				
Input	signal voltage	24 V DC		-
	characteristic acc. to EN 61132-2	Type 1		-
0 signal		-3...+5 V DC		-
Undefined signal state		5...15 V DC		-
1 signal		15...30 V DC		-
Residual ripple, range for	0 signal	-3...+5 V DC		-
	1 signal	15...30 V DC		-
Input time delay (0 -> 1 or 1 -> 0)		8 ms typically, configurable from 0.1 up to 32 ms		-
Digital outputs				
Transistor outputs 24 V DC, 0.5 A	●		-	-
Readback of output	-	● (on DC outputs)		-
Outputs, supplied via process voltage UP	●		-	-
Switching of 24 V load	●		-	-
Output voltage at signal state 1	Process voltage UP - 0.8 V		-	-
Output current				
Nominal current per channel	500 mA at UP = 24 V DC		-	-
Maximum (total current of all channels)	8 A		-	-
Residual current at signal state 0	< 0.5 mA		-	-
Demagnetization when switching off inductive loads	By internal varistors		-	-

(1) Not simultaneously.

AC500

Technical data

PROFINET® IO RT device modules

Type	CI501-PNIO	CI502-PNIO	CI504-PNIO	CI506-PNIO
Analog inputs AI				
Max. number per module and with regard to the configuration: AIs / Measuring points				
Signal configuration per AI	4	–	–	–
0...10 V / -10...+10 V	4 / 4	–	–	–
0...20 mA / 4...20 mA	4 / 4	–	–	–
RTD using 2/3 wire needs 1/2 channel(s)	4 / 2	–	–	–
0...10 V using differential inputs, needs 2 channels	4 / 2	–	–	–
-10...+10 V using differential inputs, needs 2 channels	4 / 2	–	–	–
Digital signals (digital input)	4 / 4	–	–	–
Data when using the AI as digital input				
Input	time delay	8 ms typically, configurable from 0.1 up to 32 ms	–	–
	signal voltage	24 V DC	–	–
Outputs, single configurable as				
Possible configuration per AO				
-10...+10 V	●	–	–	–
0...20 mA / 4...20 mA	●	–	–	–
Output	resistance (load) when used as current output	0...500 Ω	–	–
	loading capability when used as voltage output	±10 mA max.	–	–
Potential isolation				
Per module	●	●	●	●
Between Ethernet interface against the rest of the module	●	●	●	●
Voltage supply for the module	By external 24 V DC voltage via terminal UP			
Process voltage UP				
Nominal voltage	24 V DC			
Maximum ripple	5 %			
Current consumption on UP				
	min. typ. (module alone)	0.260 A	0.150 A	
	max. typ. (min. + loads)	0.260 A + load	0.150 A	
Reverse polarity protection	●			
Fuse for process voltage UP	10 A miniature fuse			
Approvals	See detailed page 168 or www.abb.com/plc			

4

AC500

Technical data

EtherCAT® modules

Type	CI511-ETHCAT	CI512-ETHCAT
Communication interface		
Protocol	EtherCAT® slave	
ID Device configuration	Address is defined by position on Ethernet bus	
Field bus connection on TUs	2 x RJ45 with switch functionality for simple daisy chain on TU507-ETH or TU508-ETH	
Number of channels per module		
Digital	inputs	8
	outputs	8
Analog	inputs	–
	outputs	–
Digital configurable channels DC (configurable as inputs or outputs)		8
Additional configuration of channels as		
Fast counter (onboard I/O)	–	
Occupies max. 1 DO or DC when used as counter	–	
Connection		
Local I/O extension	●	
Max. number of extension modules	max. 10 x S500 extension modules (standard or eCo modules allowed). Fast counter from digital IO modules can be also used.	
Via terminal unit TU5xx	●	
Digital inputs		
Input signal voltage	24 V DC	
Input characteristic acc. to EN 61 132-2	Type 1	
0 signal	–3...+5 V DC	
Undefined signal state	5...15 V DC	
1 signal	15...30 V DC	
Residual ripple, range for	0 signal	–3...+5 V DC
	1 signal	15...30 V DC
Input time delay (0 -> 1 or 1 -> 0)	8 ms typically, configurable from 0.1 up to 32 ms	
Digital outputs		
Transistor outputs 24 V DC, 0.5 A	●	
Readback of output	–	● (on DC outputs)
Outputs, supplied via process voltage UP	●	
Switching of 24 V load	●	
Output voltage at signal state 1	Process voltage UP - 0.8 V	
Output current		
Nominal current per channel	500 mA at UP = 24 V DC	
Maximum (total current of all channels)	8 A	
Residual current at signal state 0	< 0.5 mA	
Demagnetization when switching off inductive loads	By internal varistors	
Analog inputs AI		
	Max. number per module and with regard to the configuration: AIs / Measuring points	
Signal configuration per AI	4	–
0...10 V / -10 V... +10 V	4 / 4	–
0...20 mA / 4...20 mA	4 / 4	–
RTD using 2/3 wire needs 1/2 channel(s)	4 / 2	–
0...10 V using differential inputs, needs 2 channels	4 / 2	–
-10...+10 V using differential inputs, needs 2 channels	4 / 2	–
Digital signals (digital input)	4 / 4	–
Data when using the AI as digital input		
Input	time delay	8 ms typically, configurable from 0.1 up to 32 ms
	signal voltage	24 V DC
Outputs, single configurable as:		
Possible configuration per AO	●	
-10...+10 V	●	
0...20 mA / 4...20 mA	●	
Output resistance (load) when used as current output	0...500 Ω	
Output loading capability when used as voltage output	±10 mA max.	

AC500

Technical data

EtherCAT® modules

Type	CI511-ETHCAT	CI512-ETHCAT
Potential isolation		
Per module	●	●
Between Ethernet interface against the rest of the module	●	●
Between the channels		
input	–	–
output	–	–
Voltage supply for the module	By external 24 V DC voltage via terminal UP	
Process voltage UP		
Nominal voltage	24 V DC	
Maximum ripple	5 %	
Current consumption on UP		
min. typ. (module alone)	0.260 A	
max. typ. (min. + loads)	0.260 A + load	
Reverse polarity protection	●	
Fuse for process voltage UP	10 A miniature fuse	
Approvals	See detailed page 168 or www.abb.com/plc	

4

AC500

Technical data

CS31 functionality

	AC500 CPU with integrated CS31 interface	S500 I/O with communication interface DC551-CS31 CI590-CS31-HA CI592-CS31
Master	Yes, at COM1	-
Slave	No	Yes / Redundant for CI590-CS31-HA
Protocols supported	ABB CS31 protocol	
Diagnosis		
Error indication	On LCD display of the CPU / AC500-eCo error LED	Via module LEDs
Online diagnosis	Yes	
Error code	Errors are recorded in the diagnosis system of the CPU	
Associated function blocks	Yes	
Physical layer		
Connection	RS485 / 2 x RS485 for CI590-CS31-HA for redundancy	Plug at COM1
Baud rate	187.5 kbit/s	Screw-type or spring-type terminals
Distance	AC500-eCo: up to 50 m and up to 500 m using the isolator TK506 / AC500: up to 500 m; up to 2000 m using a repeater	
Max. number of modules on fieldbus	31 modules max. Please note: The CS31 bus interface occupies one or two module addresses (if counters are configured onboard or if the module is a mixed digital analog module). Depending on the configuration, or if the module contains also mixed digital analog I/O, connected extension modules can occupy further module addresses.	
Configuration		
Station address configuration	Using configuration tool (included in Automation Builder software suite)	
	No	Using rotary switches (99 max.)

4

Digital and mixed signal I/O modules, "Fast Counter" operating modes. Not applicable for DC541 or eCo-I/O modules (1)

Operating mode, configured in the user program of the AC500	Occupied inputs DI or DC	Occupied outputs DO or DC	Maximum counting frequency kHz
0 No counter	0	0	-
1 One count-up counter with "end value reached" indication	1	1	50
2 One count-up counter with "enable" input and "end value reached" indication	2	1	50
3 Two up/down counters	2	0	50
4 Two up/down counters with 1 counting input inverted	2	0	50
5 One up/down counter with "dynamic set" input	2	0	50
6 One up/down counter with "dynamic set" input	2	0	50
7 One up/down counter with directional discriminator For synchro transmitters using two counting pulses with an offset of 90° (track A and B)	2	0	50
8 -	0	0	-
9 One up/down counter with directional discriminator and double evaluation For synchro transmitters using two counting pulses with an offset of 90° towards each other (track A and B)	2	0	30
10 One up/down counter with directional discriminator and fourfold evaluation For synchro transmitters using two counting pulses with an offset of 90° towards each other (track A and B)	2	0	15

(1) See technical documentation for details.

AC500

System data

Operating and ambient conditions

Voltages according to EN 61131-2

24 V DC	Process and supply voltage	24 V DC (-15 %, +20 % without ripple)
	Absolute limits	19.2...30 V inclusive ripple
	Ripple	< 5 %
	Protection against reverse polarity	10 s
120 V AC	Line voltage	120 V AC (-15 %, +10 %)
	Frequency	47...62.4 Hz / 50...60 Hz (-6 %, +4 %)
230 V AC	Line voltage	230 V AC (-15 %, +10 %)
	Frequency	47...62.4 Hz / 50...60 Hz (-6 %, +4 %)
120-240 V AC	Wide-range supply	-
	Line voltage	102...264 V / 120...240 V (-15 %, +10 %)
	Frequency	47...62.4 Hz / 50...60 Hz (-6 %, +4 %)
Allowed interruptions of power supply acc. to EN 61131-2	DC supply	Interruption < 10 ms, time between 2 interruptions > 1 s, PS2
	AC supply	Interruption < 0.5 periods, time between 2 interruptions > 1 s

Important: Exceeding the maximum power supply voltage (> 30 V DC) for process or supply voltages could lead to unrecoverable damage of the system. The system could be destroyed.

Temperature	Operation	0...60 °C (horizontal mounting of modules)
		0...40 °C (vertical mounting of modules and output load reduced to 50 % per group)
	Storage	-40...+70 °C
	Transport	-40...+70 °C
Humidity		Max. 95 %, without condensation
Air pressure	Operation	> 800 hPa / < 2000 m
	Storage	> 660 hPa / < 3500 m

Creepage distances and clearances

Insulation Test Voltages, Routine Test, according to EN 61131-2		High voltage pulse 1.2/50 µs	AC voltage during 2 seconds
Circuits against other circuitry	230 V	2500 V	1350 V
	120 V	1500 V	820 V
	120...240 V	2500 V	1350 V
24 V circuits (supply, 24 V inputs/outputs), if they are electrically isolated against other circuitry		500 V	350 V
COM interfaces, electrically	isolated	500 V	350 V
	not isolated	not applicable	not applicable
FBP interface		500 V	350 V
Ethernet		500 V	350 V

The creepage distances and clearances meet the requirements of the overvoltage category II, pollution degree 2.

Main dimensions mm, inches

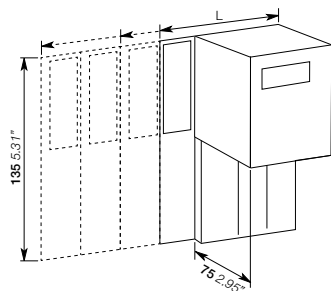

Type	Nr communication modules	Length L	
		mm	inches
TB511-ETH	1	95.5	3.76
TB521-ETH	2	123.5	4.86
TB541-ETH	4	179.5	7.07

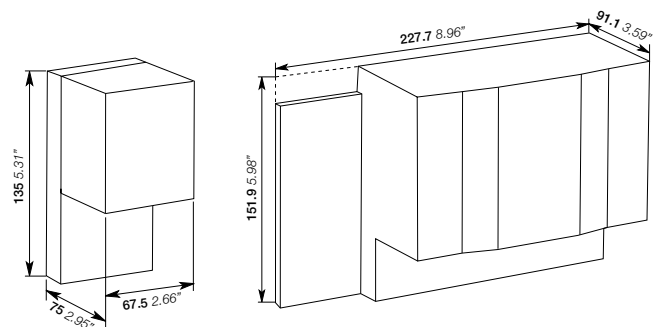

AC500

System data

Power supply units

For the supply of the modules, power supply units according to PELV specifications must be used.

Electromagnetic Compatibility

Immunity

Against electrostatic discharge (ESD)		According to EN 61000-4-2, zone B, criterion B
Electrostatic voltage in case of	air discharge	8 kV
	contact discharge	4 kV, in a closed switch-gear cabinet 6 kV (1)
ESD with communication connectors		In order to prevent operating malfunctions, it is recommended, that the operating personnel discharge themselves prior to touching communication connectors or perform other suitable measures to reduce effects of electrostatic discharges.
ESD with connectors of Terminal Bases		The connectors between the terminal bases and CPUs or communication modules must not be touched during operation. The same is valid for the I/O-Bus with all modules involved.
Against the influence of radiated (CW radiated)		According to EN 61000-4-3, zone B, criterion A
Test field strength		10 V/m
Against transient interference voltages (burst)		According to EN 61000-4-4, zone B, criterion B
Supply voltage units	AC / DC	2 kV
Digital inputs/outputs	24 V DC	2 kV
	120/230 V AC	2 kV
Analog inputs/outputs		1 kV
CS31 system bus		2 kV
Serial RS485 interfaces (COM)		2 kV
Serial RS232 interfaces (COM, not for PM55x and PM56x)		1 kV
ARCNET		1 kV
FBP		1 kV
Ethernet		1 kV
I/O supply, DC-out		1 kV
Against the influence of line-conducted interferences (CW conducted)		According to EN 61000-4-6, zone B, criterion A
Test voltage		3 V zone B, 10 V is also met
High energy surges		According to EN 61000-4-5, zone B, criterion B
Power supply DC		1 kV CM (2) / 0.5 kV DM (2)
DC I/O supply		0.5 kV CM (2) / 0.5 kV DM (2)
Buses, shielded		1 kV CM (2)
AC-I/O unshielded		2 kV CM (2) / 1 kV DM (2)
I/O analog, I/O DC unshielded		1 kV CM (2) / 0.5 kV DM (2)
Radiation (radio disturbance)		According to EN 55011, group 1, class A

(1) High requirement for shipping classes are achieved with additional specific measures (see specific documentation).

(2) CM = Common Mode - DM = Differential Mode.

Mechanical Data

Wiring method / terminals

Mounting	Horizontal
Degree of protection	IP20 (if all terminal screws are tightened)
Housing	According to UL 94
Vibration resistance acc. to EN 61131-2	all three axes 2...15 Hz, continuous 3.5 mm 15...150 Hz, continuous 1 g (higher values on request)
Vibration resistance with SD Memory Card inserted	15...150 Hz, continuous 1 g
Shock resistance	All three axes 15 g, 11 ms, half-sinusoidal
Shipping specific requirements	-
Mounting of the modules	
DIN rail according to DIN EN 50022	35 mm, depth 7.5 mm or 15 mm
Mounting with screws	Screws with a diameter of 4 mm
Fastening torque	1.2 Nm

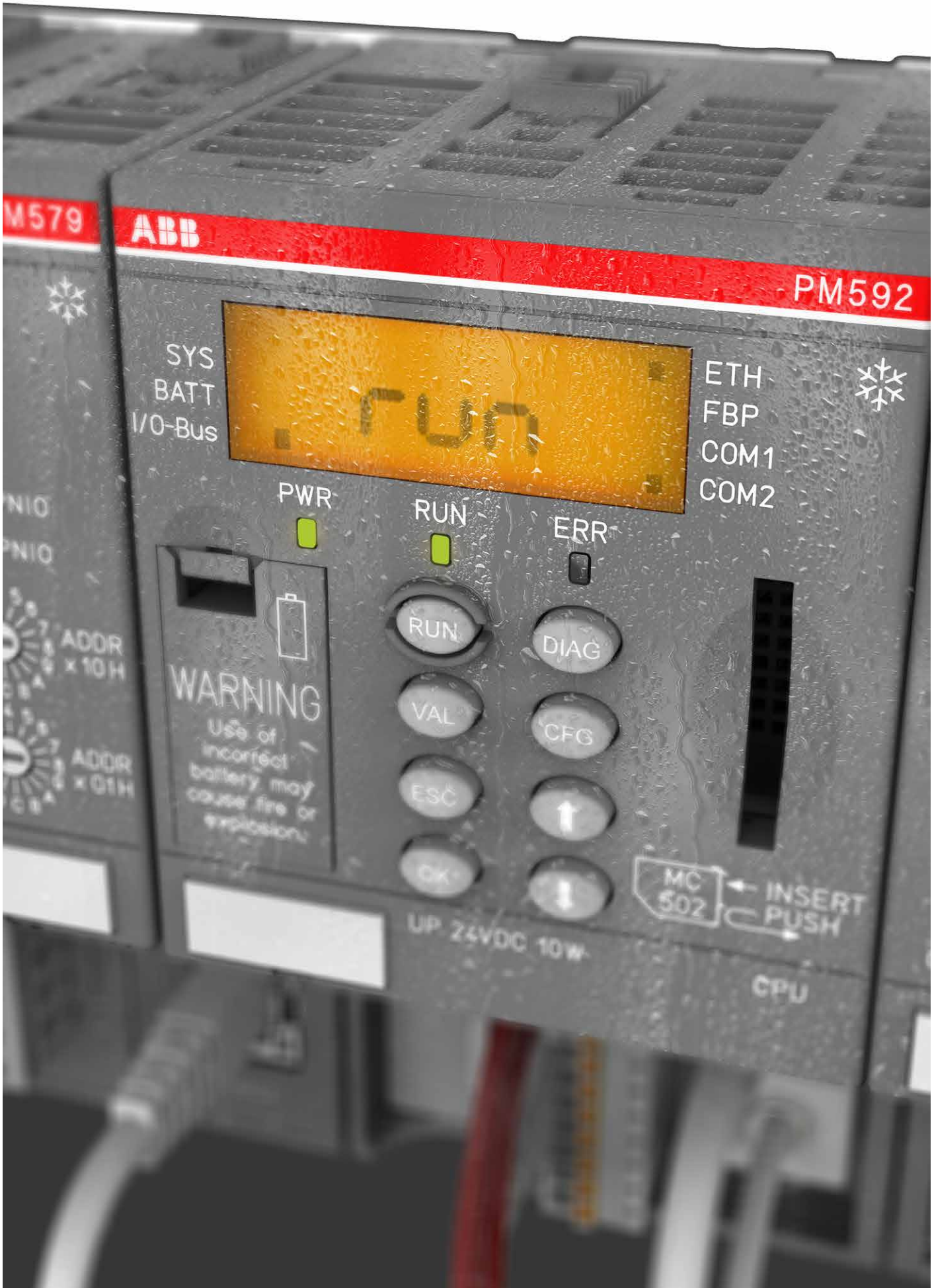

AC500-XC

PLC operating in eXtreme Conditions

Key features	5/88
PLC operating in eXtreme Conditions	5/89
Technical data	5/95
System data	5/115

AC500-XC

Key features

5

Lower lifetime cost and many of the traditional practices are not required, such as: HVAC for the panel, shock absorbers, door sealing, etc...



- Resistance to:
- High humidity
 - Salt mist
 - Vibration
 - High altitude
 - Corrosive gases
 - Temperature: from -40 to +70 °C

All the benefits from AC500 line: Automation Builder productivity suite, I/O modules, scalable and flexible, same high performance communication, libraries and web services.

AC500-XC

PLC operating in eXtreme Conditions



PM573-ETH-XC



PM592-ETH-XC



PM595-4ETH-M-XC



TB511-ETH-XC



TB541-ETH-XC

AC500 CPUs

- 2 internal serial interfaces, RS232 / RS485 configurable
- Display and 8 function keys for diagnosis and status
- Centrally expandable with up to 10 I/O modules (S500) for a total of 320 Digital I/Os or 160 Analog I/Os
- Simultaneous operation of up to 4 external communication modules in any desired combination
- Optional SD card for data storage and program backup
- Can also be used as slave CANopen® using CM588-CN-XC slave coupler
- Ethernet version provides web server and IEC 60870-5-104 remote control protocol.

Program memory kB	Cycle time in µs per instruction min. Bit/Word/Float. point	Integrated communication	Type	Order code	Price	Weight (1 pce) kg
512	0.06 / 0.09 / 0.7	Ethernet (2), 2 x serial	PM573-ETH-XC (1)	1SAP330300R0271		0.150
512	0.05 / 0.06 / 0.5	2 x serial	PM582-XC	1SAP340200R0201		0.135
1024	0.05 / 0.06 / 0.5	Ethernet (2), 2 x serial	PM583-ETH-XC (1)	1SAP340300R0271		0.150
4096	0.002 / 0.004 / 0.004	Ethernet (2), 2 x serial	PM591-ETH-XC (1)	1SAP350100R0271		0.150
4096	0.002 / 0.004 / 0.004	Ethernet (2), 2 x serial	PM592-ETH-XC (1)(3)	1SAP350200R0271		0.150

AC500 CPU PM595

- 2 Ethernet interfaces with integrated switch and software configurable protocol (PROFINET, EtherCAT (4))
- 2 Ethernet interfaces
- 2 serial interfaces, RS232 / RS485 configurable
- Provides web server and IEC 60870-5-104 telecontrol protocol
- Centrally expandable with up to 10 I/O modules (S500 and/or S500-eCo modules allowed)
- Simultaneous operation of up to 2 external communication modules in any desired combination

Program memory MB	Cycle time in µs per instruction min. Bit/Word/Float. point	Integrated communication	Type	Order code	Price	Weight (1 pce) kg
16	0.0006/0.001/0.001	2 x Ethernet (2 Ports switch), 2 x Ethernet (2), 2 x serial	PM595-4ETH-M-XC	1SAP351500R0279		1.050

(1) Ethernet communication.

(2) Provides integrated web server and IEC 60870-5-104 remote control protocol on each interface independently.

(3) Provides integrated 4 GB flashdisk for user data storage and data logging.

(4) Availability on demand.

Terminal base

- For mounting and connection of the CPUs and communication modules, not needed for PM595
- 1 to 4 plug-in communication modules
- Connection for communication coupler integrated in the CPU
- I/O interface for direct connection of up to 10 expansion modules
- Connection COM1: 9-pole pluggable terminal block
- Connection COM2: 9-pole Sub-D (socket).

Number of coupler slots	Connection for coupler integrated in the CPU	Type	Order code	Price	Weight (1 pce) kg
1	Ethernet RJ45	TB511-ETH-XC	1SAP311100R0270		0.215
2	Ethernet RJ45	TB521-ETH-XC	1SAP312100R0270		0.215
4	Ethernet RJ45	TB421-ETH-XC	1SAP314100R0270		0.215

AC500-XC

PLC operating in eXtreme Conditions



CM572-DP-XC



CM579-PNIO-XC

Communication modules

Protocol	Connections	Type	Order code	Price	Weight (1 pce) kg
PROFIBUS® DP V0/V1 master	Sub-D socket 9 poles	CM572-DP-XC	1SAP370200R0001		0.115
Ethernet (TCP/IP, UDP/IP, Modbus TCP)	2 x RJ45 - integrated switch	CM597-ETH-XC	1SAP373700R0001		0.115
CANopen® master	Terminal block 5 poles spring	CM578-CN-XC	1SAP370800R0001		0.115
CANopen® slave	Terminal block 2 x 5 poles spring	CM588-CN-XC	1SAP372800R0001		0.115
PROFINET® I/O RT controller	2 x RJ45 - integrated switch	CM579-PNIO-XC	1SAP370901R0101		0.115
PROFINET® I/O RT device	2 x RJ45 - integrated switch	CM589-PNIO-XC	1SAP372900R0011		0.115

I/O modules

- For central expansion of the AC500-XC CPU
- For decentralized expansion in combination with communication interface module (not for DC505-FBP)
- DC: channels can be configured individually as inputs or outputs
- Terminal unit required (refer to table below).

Digital I/O

Number of	Input signal	Output type	Output signal	Terminal units	Type	Order code	Price	Weight (1 pce) kg
DI/DO/DC								
32 / - / -	24 V DC	-	-	TU516-XC	DI524-XC	1SAP440000R0001		0.200
- / - / 16	24 V DC	Transistor	24 V DC, 0.5 A	TU516-XC	DC522-XC	1SAP440600R0001		0.200
- / - / 24	24 V DC	Transistor	24 V DC, 0.5 A	TU516-XC	DC523-XC	1SAP440500R0001		0.200
16 / - / 16	24 V DC	Transistor	24 V DC, 0.5 A	TU516-XC	DC532-XC	1SAP440100R0001		0.200
- / 32 / -	24 V DC	Transistor	24 V DC, 0.5 A	TU516-XC	DO524-XC	1SAP440700R0001		0.200
8 / 8 / -	24 V DC	Relay	230 V AC, 3 A (1)	TU532-XC	DX522-XC	1SAP445200R0001		0.200

(1) Relay outputs, changeover contacts.

Analog I/O

Number of	Input signal	Output signal	Terminal units	Type	Order code	Price	Weight (1 pce) kg
A/AO							
16 / 0	0...10 V, ±10 V 0/4...20 mA	-	TU516-XC	AI523-XC	1SAP450300R0001		0.200
4 / 4	PT100, PT1000, Ni1000	±10 V	TU516-XC	AX521-XC	1SAP450100R0001		0.200
8 / 8 (max. 4 current outputs)		0/4...20 mA	TU516-XC	AX522-XC	1SAP450000R0001		0.200
0 / 16 (max. 8 current outputs)			TU516-XC	AO523-XC	1SAP450200R0001		0.200
8 / 0	0...5 V, 0...10 V, ±50 mV, ±500 mV, 1 V, ±5 V, ±10 V, 0/4...20 mA, ±20 mA PT100, PT1000, Ni1000, Cu50, 0...50 kΩ, S, T, N, K, J		TU516-XC	AI531-XC	1SAP450600R0001		0.200

Analog/digital mixed I/O

Standard I/O module with high functionality:

- 16 digital input channels
- 8 configurable In/Output channels
- First two inputs are also usable as high-speed counter (up to 50 kHz) together with AC500-XC CPU, CS31 or CI5xx-XC communication interface modules
- 4 independent analog input channels configurable for voltage, current, 12 bit + sign, 1-2 wire connection
- Galvanic isolation per module
- Usable with all CI5xx modules.

Number of	Input signal	Output type	Output signal	Terminal unit	Type	Order code	Price	Weight (1 pce) kg
A/AO/DI/DO/DC								
4 / 2 / 16 / - / 8	24 V DC, 0...10 V, ±10 V, 0/4...20 mA, PT100, PT1000, Ni100, Ni1000	Transistor	24 V DC, 0.5 A ±10 V, 0/4...20 mA	TU516-XC	DA501-XC	1SAP450700R0001		0.200



DI524-XC



DO524-XC



AI523-XC



AO523-XC



DA501-XC

AC500-XC

PLC operating in eXtreme Conditions



CD522-XC

Multifunctional modules

Functionality	Number of	Input signal	Output type	Output signal	Terminal unit	Type	Order code	Price	Weight (1 pce)
DI/DO/DC									
Encoder module									
Encoder and PWM module	2 / - / 8	24 V DC and 2 encoder inputs	2 PWM outputs	-	TU516-XC	CD522-XC	1SAP460300R0001		0.125

- DC541-XC occupies one communication module slot on the AC500-XC CPU terminal base, no terminal block required
- Usable with all CI5xx-XC modules.

Functionality	Number of	Input signal	Output type	Output signal	Terminal unit	Type	Order code	Price	Weight (1 pce)
DI/DO/DC									
Interrupt I/O and fast counter module									
Interrupt I/O and fast counter	- / - / 8	24 V DC	Transistor	24 V DC, 0.5 A	N/A (2)	DC541-CM-XC (1)	1SAP470000R0001		0.100

- (1) Multifunctional module, refer to table on page 103 for details.
 (2) Occupies a communication module slot.

AC500-XC

PLC operating in eXtreme Conditions



DC551-CS31-XC



CI541-DP-XC



CI581-CN-XC



CI502-PNIO-XC



CI506-PNIO-XC

Communication interface modules

Number of	Input signal	Output type	Output signal	Terminal units	Type	Order code	Price	Weight (1 pce)
-----------	--------------	-------------	---------------	----------------	------	------------	-------	----------------

AI/AO/DI/DO/DC

Communication interface module for CS31-Bus

- / - / 8 / - / 16	24 V DC	Transistor	24 V DC, 0.5 A	TU552-CS31-XC	DC551-CS31-XC	1SAP420500R0001		0.200
- / - / - / - / 16	24 V DC	Transistor	24 V DC, 0.5 A	TU552-CS31-XC	CI590-CS31-HA-XC	1SAP421100R0001		0.200
4 / 2 / 8 / - / 8	24 V DC / 0...10 V, -10...+10 V, 0...20 mA, 4...20 mA, PT100, PT1000, Ni100, Ni1000	Transistor	24 V DC, 0.5 A / -10...+10 V, 0...20 mA, 4...20 mA	TU552-CS31-XC	CI592-CS31-XC	1SAP421200R0001		0.200

Communication interface module for PROFIBUS®-DP

4 / 2 / 8 / 8 / -	24 V DC / 0...10 V, -10...+10 V, 0...20 mA, 4...20 mA, PT100, PT1000, Ni100, Ni1000	Transistor	24 V DC, 0.5 A / -10...+10 V, 0...20 mA, 4...20 mA	TU510-XC / TU518-XC	CI541-DP-XC	1SAP424100R0001		0.200
- / - / 8 / 8 / 8	24 V DC	Transistor	24 V DC, 0.5 A	TU510-XC / TU518-XC	CI542-DP-XC	1SAP424200R0001		0.200

Communication interface module for CANopen®

4 / 2 / 8 / 8 / -	24 V DC / 0...10 V, -10...+10 V, 0...20 mA, 4...20 mA, PT100, PT1000, Ni100, Ni1000	Transistor	24 V DC, 0.5 A / -10...+10 V, 0...20 mA, 4...20 mA	TU510-XC / TU518-XC	CI581-CN-XC	1SAP428100R0001		0.200
- / - / 8 / 8 / 8	24 V DC	Transistor	24 V DC, 0.5 A	TU510-XC / TU518-XC	CI582-CN-XC	1SAP428200R0001		0.200

Communication interface module for Ethernet based protocol - PROFINET® IO RT

4 / 2 / 8 / 8 / -	24 V DC / 0...10 V, -10...+10 V, 0...20 mA, 4...20 mA, PT100, PT1000, Ni100, Ni1000	Transistor	24 V DC, 0.5 A / -10...+10 V, 0...20 mA, 4...20 mA	TU508-ETH-XC	CI501-PNIO-XC	1SAP420600R0001		0.200
- / - / 8 / 8 / 8	24 V DC	Transistor	24 V DC, 0.5 A	TU508-ETH-XC	CI502-PNIO-XC	1SAP420700R0001		0.200

From	To	Output signal	Terminal units	Type	Order code	Price	Weight (1 pce)
------	----	---------------	----------------	------	------------	-------	----------------

Communication interface module gateway for Ethernet based protocol - PROFINET® IO RT

PROFINET® I/O	-	3 x RS232/485 ASCII serial interfaces	TU520-ETH-XC	CI504-PNIO-XC	1SAP421300R0001		0.200
PROFINET® I/O	1 x CAN 2A/2B or CANopen® Master	2 x RS232/485 ASCII serial interfaces	TU520-ETH-XC	CI506-PNIO-XC	1SAP421500R0001		0.200

AC500-XC

PLC operating in eXtreme Conditions



TU516-XC

Terminal units

For digital and analog expansion modules and interface modules. Please note: for modules with relay outputs, terminal units for 230 V AC (TU532-XC) is required.

For	Supply	Connection type	Type	Order code	Price	Weight (1 pce) kg
Ethernet interface modules	24 V DC	Spring	TU508-ETH-XC	1SAP414000R0001		0.300
CANopen®/PROFIBUS® DP interface modules	24 V DC	Spring	TU510-XC	1SAP410800R0001		0.300
I/O modules	24 V DC	Spring	TU516-XC	1SAP412000R0001		0.300
CANopen®/PROFIBUS® DP interface modules	24 V DC	Spring	TU518-XC (1)	1SAP411200R0001		0.300
Ethernet gateway modules	24 V DC	Spring	TU520-ETH-XC	1SAP414400R0001		0.300
I/O modules AC / Relay	230 V AC	Spring	TU532-XC	1SAP417000R0001		0.300
CS31 interface modules	24 V DC	Spring	TU552-CS31-XC	1SAP410400R0001		0.300

(1) TU518-XC Terminal units can also be used with PROFIBUS® DP CI modules with baud rate up to 1Mbaud.



TU520-ETH-XC

Terminal units compatibility

Type	For I/O modules		For communication interface modules				
	TU516-XC	TU532-XC	TU508-ETH-XC	TU510-XC	TU518-XC	TU520-ETH-XC	TU552-CS31-XC
DA501-XC	●						
DC522-XC	●						
DC523-XC	●						
DC532-XC	●						
DI524-XC	●						
DX522-XC		●					
CD522-XC	●						
AI523-XC	●						
AI531-XC	●						
AO523-XC	●						
AX521-XC	●						
AX522-XC	●						
DC551-CS31-XC							●
CI590-CS31-HA-XC							●
CI592-CS31-XC							●
CI501-PNIO-XC			●				
CI502-PNIO-XC			●				
CI504-PNIO-XC						●	
CI506-PNIO-XC						●	
CI541-DP-XC				●	● (1)		
CI542-DP-XC				●	● (1)		
CI581-CN-XC					●		
CI582-CN-XC					●		

(1) Can be used with baudrate up to 1Mbaud.



TU510-XC



TU508-ETH-XC

AC500-XC

PLC operating in eXtreme Conditions



MC502

Accessories for AC500-XC

For	Description	Type	Order code	Price	Weight (1 pce) kg
AC500 CPUs COM1	Programming cable Sub-D / terminal block, length 5 m	TK502	1SAP180200R0101		0.400
AC500 CPUs COM2	Programming cable Sub-D / Sub-D, length 5 m	TK501	1SAP180200R0001		0.400
AC500 CPUs	Memory card (2 GB SD card)	MC502	1SAP180100R0001		0.020
	Lithium battery for data buffering	TA521	1SAP180300R0001		0.100
I/O modules	Pluggable marker holder for I/O modules, packing unit incl. 10 pcs. Template available in the AC500 online help	TA523	1SAP180500R0001		0.300
AC500 CPU's, interface module, communication module and I/O modules	White labels, packing unit incl. 10 pcs	TA525	1SAP180700R0001		0.100
Terminal base	Communication Module, blind cap	TA524	1SAP180600R0001		0.120
CPU terminal base	Accessories for mounting, packing unit includes 10 pcs	TA526	1SAP180800R0001		0.200
	5-pole power plug for AC500. Spare part. Can be plugged to CPU terminal base TB5x1. Packing unit includes 5 pcs	TA527	1SAP181100R0001		0.200
	9-pole COM1 plug for AC500. Spare part. Can be plugged to CPU terminal base TB5x1. Packing unit includes 5 pcs	TA528	1SAP181200R0001		0.200
Protective caps for TB, TU and CM	10 x Sub-D plastic caps 20 x RJ45 plastic caps, 3 x RJ45 female 10 x M12 plastic caps	TA535	1SAP182300R0001		0.300
AC500 CPUs PM595	Protective cap, spare-parts, 3 pieces	TA540	1SAP182600R0001		0.200
	Lithium battery for real-time-clock buffering	TA541	1SAP182700R0001		0.030
	Accessories for screw-mounting, 20 pieces	TA543	1SAP182800R0001		0.100

AC500-XC

Technical data

AC500-XC CPUs

Type	PM573-ETH-XC	PM582-XC	PM583-ETH-XC	PM591-ETH-XC	PM592-ETH-XC	PM595-4ETH-M-XC
Supply voltage	24 V DC					
Current consumption on 24 V DC						
Min. typ. (module alone)	0.110 A	0.050 A	0.110 A	0.150 A		0.400 A
Max. typ. (all couplers and I/Os)	0.810 A	0.750 A	0.810 A	0.850 A		1.2 A
User program memory - Flash EPROM and RAM	512 kB	512 kB	1024 kB	4096 kB		16384 kB
Integrated user data memory	512 kB thereof 288 kB saved	416 kB thereof 288 kB saved	1024 kB thereof 288 kB saved	5632 kB thereof 1536 kB saved		16384 kB thereof 3072 kB saved
User Flashdisk (Data-storage, program access or also external with FTP)	-					Yes, 4 GB Flash non removable
Plug-in memory card	depending on SD-Card used: no SD-HC card allowed, use MC502 accessory					
Web server's data for user RAM disk	1 024 kB	-	4 096 kB	8 MB		32 MB
Cycle time for 1 instruction (minimum)						
Binary	0.06 µs	0.05 µs		0.002 µs		0.0006 µs
Word	0.09 µs	0.06 µs		0.004 µs		0.001 µs
Floating-point	0.7 µs	0.5 µs		0.004 µs		0.001 µs
Max. number of centralized inputs/outputs						
Max. number of extension modules on I/O bus	up to max. 10 (S500 allowed)					
Digital inputs / outputs	320 / 320					
Analog inputs / outputs	160 / 160					
Max. number of decentralized inputs/outputs	depends on the used standard Fieldbus (1)					
Data buffering	battery					no battery needed
Real-time clock (with battery back-up)	●					
Program execution						
Cyclical / Time controlled / Multi tasking	● / ● / ●					
User program protection by password	●					
Internal interfaces						
COM1						
RS232 / RS485 configurable	●					
Connection (on terminal bases)	pluggable spring terminal block, use TK502 cable in accessory					
Programming, Modbus® RTU, ASCII, CS31 master	●					
COM2						
RS232 / RS485 configurable	●					
Connection (on terminal bases)	Sub-D female 9 poles, use TK501 cable in accessory					
Programming, Modbus® RTU, ASCII	●					
FieldBusPlug						
Serial neutral interface	●					
Connection (on terminal bases)	M12 male, 5 poles					
Functions	programming cable UTF-21-FBP, slave communication depending on FieldBusPlug used (PROFIBUS® DP, CANopen®, DeviceNet)					
Ethernet						
Ethernet connection (on terminal bases)	RJ45	-	RJ45	RJ45	RJ45	2x RJ45
Ethernet functions: Programming, TCP/IP, UDP/IP, Modbus® TCP, integrated Web server, IEC60870-5-104 remote control protocol, SNTP (simple Network Time Protocol), DHCP, PING, SMTP FTP server	●	-	●	●	●	●
Ethernet based Fieldbus						
Ethernet connection (on CPU module)	-					4 x RJ45 (2 x interfaces with 2-port switch)
Downloadable protocols like: PROFINET® IO RT Controller / Device (2) EtherCAT® (2) Master / Slave	-					●
LCD display and 8 function keys	●					
Function	RUN / STOP, status, diagnosis					Status, diagnosis
RUN / STOP, RESET push buttons	-					
LEDs for various status display	-					
Timers / Counters	unlimited / unlimited					
Approvals	See detailed page 168 or www.abb.com/plc					

(1) e.g. CS31 Fieldbus: up to 31 stations with up to 120 DI / 120 DOs or up to 32 AIs / 32 AOs per station.

(2) Availability on demand

AC500-XC

Technical data

Digital S500-XC I/O modules

Type	DI524-XC	DC522-XC	DC523-XC	DC532-XC	DO524-XC	DX522-XC
Number of channels per module						
Digital inputs	32	-	-	16	-	8
Digital outputs	-	-	-	-	32	8 relays
Configurable channels DC (configurable as inputs or outputs)	-	16	24	16	-	-
Additional configuration of channels as						
Fast counter	configuration of max. 2 channels per module, operating modes see table on page 114					
Occupies max. 1 DO or DC when used as counter	-	●	●	●	-	-
Connection via terminal unit	●	●	●	●	●	●
Digital inputs						
Input signal voltage	24 V DC				-	24 V DC
Input characteristic acc. to EN 61132-2	Type 1				-	Type 1
0 signal	-3...+5 V DC				-	-3...+5 V DC
Undefined signal state	5...15 V DC				-	5...15 V DC
1 signal	15...30 V DC				-	15...30 V DC
Input time delay (0 -> 1 or 1 -> 0)	8 ms typically, configurable from 0.1 up to 32 ms				-	8 ms typically, configurable from 0.1 up to 32 ms
Input current per channel						
At input voltage	24 V DC	5 mA typically			-	5 mA typically
	5 V DC	> 1 mA			-	> 1 mA
	15 V DC	> 5 mA			-	> 5 mA
	30 V DC	< 8 mA			-	< 8 mA
Digital outputs						
Transistor outputs 24 V DC, 0.5 A	-	●	●	●	●	-
Readback of output	-	●	●	●	-	-
Relay outputs, supplied via process voltage UP, changeover contacts	-	-	-	-	-	●
Switching of load	24 V	●	●	●	●	●
	230 V	-	-	-	-	●
Output voltage at signal state 1	-	process voltage UP minus 0.8 V				-
Output current						
Nominal current per channel	-	500 mA at UP = 24 V				-
Maximum (total current of all channels)	-	8 A				-
Residual current at signal state 0	-	< 0.5 mA				-
Demagnetization when switching off inductive loads	-	by internal varistors				-
Switching frequency						
For inductive load	-	0.5 Hz max.			0.5 Hz max.	2 Hz
For lamp load	-	11 Hz max. at max. 5 W				
Short-circuit / overload proofness	-	●	●	●	●	by external fuse / circuit breaker 6 A gL/gG per channel
Overload indication (I > 0.7 A)	-	after approx. 100 ms				
Output current limiting	-	yes, with automatic reclosure				
Proofness against reverse feeding of 24 V signals	-	●	●	●	●	-
Contact rating						
For resistive load, max.	-					3 A at 230 V AC 2 A at 24 V DC
For inductive load, max.	-					1.5 A at 230 V AC 1.5 A at 24 V DC
For lamp load	-					60 W at 230 V AC 10 W at 24 V DC
Lifetime (switching cycles)						
Mechanical lifetime	-					300 000
Lifetime under load	-					300 000 at 24 V DC / 2 A 200 000 at 120 V AC / 2 A 100 000 at 230 V AC / 3 A
Spark suppression for inductive AC load	-					external measure depending on the switched load
Demagnetization for inductive DC load	-					external measure: free-wheeling diode connected in parallel to the load

AC500-XC

Technical data

Digital S500-XC I/O modules

Type	DI524-XC	DC522-XC	DC523-XC	DC532-XC	DO524-XC	DX522-XC
Process voltage UP						
Nominal voltage	24 V DC					
Maximum ripple	5 %					
Current consumption on UP						
Min. typ. (module alone)	0.150 A	0.100 A	0.150 A		0.050 A	0.050 A
Max. typ. (min. + loads)	0.150 A	0.100 A + load	0.150 A + load		0.100 A + load	0.050 A + load
Reverse polarity protection	●	●	●	●	●	●
Fuse for process voltage UP	10 A miniature fuse					
Connections for sensor voltage supply. Terminal 24 V and 0 V for each connection. Permitted load for each group of 4 or 8 connections: 0.5 A	-	8	4	-	-	-
Short-circuit and overload proof 24 V DC sensor supply voltage	-	●	●	-	-	-
Maximum cable length for connected process signals						
Cable	shielded	1000 m				
	unshielded	600 m				
Potential isolation						
Per module		●	●	●	●	●
Between channels	input	-	-	-	-	-
	output	-	-	-	-	●
Voltage supply for the module	internally via extension bus interface (I/O bus)					
Fieldbus connection	via AC500-XC CPU or all communication interface modules (except DC505-FBP Fieldbus Plug module)					
Address setting	automatically (internal)					

AC500-XC

Technical data

Analog S500-XC I/O modules

Type		AX521-XC	AX522-XC	AI523-XC	AO523-XC	AI531-XC
Number of channels per module	Individual configuration, analog					
	inputs	4	8	16	-	8
	outputs	4	8	-	16	-

Signal resolution for channel configuration

-10...+10 V	12 bits + sign					15 bits + sign
0...10 V	12 bits					15 bits
0...20 mA, 4...20 mA	12 bits					15 bits
Temperature: 0.1 °C	●	●	●	●	●	●

Monitoring configuration per channel

Plausibility monitoring	●	●	●	●	●	●
Wire break & short-circuit monitoring	●	●	●	●	●	●

Analog Inputs AI

Signal configuration per AI	max. number per module and with regard to the configuration: AIs / Measuring points (depending on the use of 2/3-wire connection or differential input)					
0...10 V	4 / 4	8 / 8	16 / 16	-	-	8 / 8
-10...+10 V	4 / 4	8 / 8	16 / 16	-	-	8 / 8
0...20 mA	4 / 4	8 / 8	16 / 16	-	-	8 / 8
4...20 mA	4 / 4	8 / 8	16 / 16	-	-	8 / 8
Pt100						
-50...+400 °C (2-wire)	4 / 4	8 / 8	16 / 16	-	-	8 / 8
-50...+400 °C (3-wire), 2 channels	4 / 2	8 / 4	16 / 8	-	-	8 / 8
-50...+400 °C (4-wire)	-	-	-	-	-	8 / 8
-50...+70 °C (2-wire)	4 / 4	8 / 8	16 / 16	-	-	8 / 8
-50...+70 °C (3-wire), 2 channels	4 / 2	8 / 4	16 / 8	-	-	8 / 8
-50...+70 °C (4-wire)	-	-	-	-	-	8 / 8
Pt1000						
-50...+400 °C (2-wire)	4 / 4	8 / 8	16 / 16	-	-	8 / 8
-50...+400 °C (3-wire), 2 channels	4 / 2	8 / 4	16 / 8	-	-	8 / 8
-50...+400 °C (4-wire)	-	-	-	-	-	8 / 8
Ni1000						
-50...+150 °C (2-wire)	4 / 4	8 / 8	16 / 16	-	-	8 / 8
-50...+150 °C (3-wire), 2 channels	4 / 2	8 / 4	16 / 8	-	-	8 / 8
-50...+150 °C (4-wire)	-	-	-	-	-	8 / 8
Thermocouples of types J, K, T, N, S						
0...10 V using differential inputs, 2 channels	4 / 2	8 / 4	16 / 8	-	-	8 / 8
-10...+10 V using differential inputs, 2 channels	4 / 2	8 / 4	16 / 8	-	-	8 / 8
Digital signals (digital input)	4 / 4	8 / 8	16 / 16	-	-	8 / 8
Input resistance per channel	voltage: > 100 kΩ current: approx. 330 Ω			-	-	voltage: > 100 kΩ current: approx. 330 Ω
Time constant of the input filter	voltage: 100 μs current: 100 μs			-	-	voltage: 100 μs current: 100 μs
Conversion cycle	2 ms (for 8 AI + 8 AO), 1 s for Pt100/1000, Ni1000			-	-	1 ms (for 8 AI + 8 AO), 1 s for Pt100/1000, Ni1000
Overvoltage protection	●	●	●	-	-	●

Data when using the AI as digital input

Input	time delay	8 ms typically, configurable from 0.1 up to 32 ms			-	8 ms typically, configurable from 0.1 up to 32 ms
	signal voltage	24 V DC			-	24 V DC
Signal	0	-30...+5 V			-	-30...+5 V
	1	13...30 V			-	13...30 V

Analog outputs AO

Possible configuration per AO	Max. number of AOs per module and with regard to the configuration:					
-10...+10 V	4	8 (1)	-	16 (1)	-	-
0...20 mA	4	-	-	8	-	-
4...20 mA	4	-	-	8	-	-
Output	resistance (burden) when used as current output	0...500 Ω			-	0...500 Ω
	loading capability when used as voltage output	Max. ±10 mA			-	Max. ±10 mA

(1) Half can be used on current (the other half remains available).

AC500-XC

Technical data

Analog S500-XC I/O modules

Type	AX521-XC	AX522-XC	AI523-XC	AO523-XC	AI531-XC
Process voltage UP					
Nominal voltage	24 V DC				
Maximum ripple	5 %				
Current consumption on UP					
Min. typ. (module alone)	0.150 A				0.130 A
Max. typ. (min. + loads)	0.150 A + load	0.150 A + load	-	0.150 A + load	
Reverse polarity protection	●	●	●	●	●
Max. line length of the analog lines, conductor cross section > 0.14 mm ²	100 m				
Conversion error of analog values caused by non-linearity, calibration errors ex works and the resolution in the nominal range	0.5 % typically, 1 % max.				
Potential isolation					
Per module	●	●	●	●	-
Fieldbus connection	Via AC500-XC CPU or all communication interface modules (except DC505-FBP)				
Voltage supply for the module	Internally via extension bus interface (I/O bus)				-

AC500-XC

Technical data

CD522-XC encoder module

The CD522-XC module offers accuracy and dynamic flexibility for a customized solution. It has two independent encoder inputs onboard and is easily configured using the Automation Builder software for 10 different operation modes and for frequencies up to 300 kHz (depending on CPU cycle time). The CD522-XC module also integrates outputs for pulses and for PWM as well as normal inputs and outputs, depending on selected encoder mode.

Type	CD522-XC	
Functionality		
Digital inputs/outputs		24 V DC, dedicated inputs/outputs can be used for specific counting functions. All unused inputs/outputs can be used as input/output with standard specification.
	Input options	Catch/Touch operation, counter value stored in separate variable on external event (rising or falling) Set to preset counter register with predefined value Set to reset counter register
	End value output	Output set when predefined value is reached
	Reference point initialization (RPI) input for relative encoder initialization	●
High-speed counter/encoder Integrated counters	Counter characteristics	2 counters (24 V DC, 5 V DC, differential and 1 V _{pp} sinus input)
	Counter mode	one 32 bits or two 16 bits
	Relative position encoder	X1, X2, X3
	Absolute SSI encoder	●
	Time frequency meter	●
	Frequency input	up to 300 kHz
PWM/pulse outputs		
Output mode specification	Number of outputs	2
	Push pull output	24 V DC, 100 mA max
	Current limitation	Thermal and overcurrent
PWM mode specification	Frequency	1...100 kHz
	Value	0...100 %
Pulse mode specification	Frequency	1...15 kHz
	Pulse emission	1...65535 pulses
	Number of pulses emitted indicator	0...100 %
Frequency mode specification	Frequency output	100 kHz
	Duty Cycle	Set to 50 %

Number of channels per module

Digital	input	2
	output	2
Configurable channels DC (configurable as inputs or outputs)		8

Additional configuration of channels as

Fast counter	Integrated 2 counter encoders
Connection via terminal unit	●

Digital Inputs

Input	signal voltage	24 V DC
	time delay	8 ms typically configurable from 0.1 up to 32 ms

Input current per channel

At input voltage	24 V DC	Typically 5 mA
	5 V DC	> 1 mA
	15 V DC	> 5 mA
	30 V DC	< 8 mA

Digital outputs

Output voltage at signal state 1	UP – 0.8 V
----------------------------------	------------

Output current

Nominal current per channel	0.5 A at UP = 24 V
Maximum (total current of all channels)	8 A
Residual current at signal state 0	< 0.5 mA
Demagnetization when switching off inductive loads	By internal varistors

Switching frequency

For inductive load	Max. 0.5 Hz
For lamp load	Max. 11 Hz with max. 5 W
Short-circuit / Overload proofness	●
Overload indication (I > 0.7 A)	After approx. 100 ms
Output current limiting	●
Proofness against reverse feeding of 24 V signals	●

AC500-XC

Technical data

CD522-XC encoder module

Type		CD522-XC
Maximum cable length for connected process signals		
Cable	shielded	1000 m
	unshielded	600 m
Potential isolation		
Per module		●
Technical data of the high-speed inputs		
Number of channels per module		6
Input type		24 V DC, 5 V DC / Differential / Sinus 1 Vpp
Frequency		300 kHz
Technical data of the fast outputs		
Number of channels		2
Indication of the output signals		Brightness of the LED depends on the number of pulses emitted (0 % to 100 %) (pulse output mode only)
Output current		
Rated value, per channel		100 mA at UP = 24 V
Maximum value (all channels together, configurable outputs included)		8 A
Leakage current with signal 0		< 0.5 mA
Rated protection fuse on UP		10 A fast
De-magnetization when inductive loads are switched off		with varistors integrated in the module
Overload message ($I > 0.1 \times A$)		Yes, after ca. 100 ms
Output current limitation		Yes, automatic reactivation after short-circuit/overload
Resistance to feedback against 24 V signals		Yes
Process voltage UP		
Nominal voltage		24 V DC
Maximum ripple		5 %
Current consumption on UP		
Min. typ. (module alone)		0.070 A
Max. typ. (min. + loads)		0.070 A + load
Reverse polarity protection		●
Fuse for process voltage UP		10 A miniature fuse

AC500-XC

Technical data

Analog/digital mixed I/O expansion module

For all modules: max cable length for connected process signals is 1000 m for shielded cable and 600 m for unshielded ones.
For all Input modules, the signal resolution for channel configuration is: -10...+10 V: 12 bit + sign; 0...10 V, 0...20 mA, 4...20 mA: 12 bits.

Type		DA501-XC
Number of Channels per Module		
Digital	inputs	16
	outputs	–
Analog	inputs	4
	outputs	2
Digital configurable channels DC (configurable as inputs or outputs)		8
Additional configuration of channels as		
Fast counter		Yes
Occupies max. 1 DO or DC when used as counter		Configuration of max. 2 channels per module. Operating modes see table on page 114
Connection via terminal unit TU 5xx		●
Digital inputs		
Input	signal voltage	24 V DC
	characteristic acc. to EN 61132-2	Type 1
0 signal		-3...+5 V DC
Undefined signal state		5...15 V DC
1 signal		15...30 V DC
Residual ripple, range for	0 signal	-3...+5 V DC
	1 signal	15...30 V DC
Input time delay (0 -> 1 or 1 -> 0)		8 ms typically, configurable from 0.1 up to 32 ms
Digital outputs		
Transistor outputs 24 V DC, 0.5 A		●
Readback of output		●
Outputs, supplied via process voltage UP		●
Switching of 24 V load		●
Output voltage at signal state 1		Process voltage UP - 0.8 V
Output current		
Nominal current per channel		500 mA at UP = 24 V DC
Maximum (total current of all channels)		8 A
Residual current at signal state 0		< 0.5 mA
Demagnetization when switching off inductive loads		By internal varistors
Analog inputs AI		
Signal configuration per AI		●
0...10 V / -10...+10 V		4 / 4
0...20 mA / 4...20 mA		4 / 4
RTD using 2/3 wire needs 1/2 channel(s)		4 / 2
0...10 V using differential inputs, needs 2 channels		4 / 2
-10...+10 V using differential inputs, needs 2 channels		4 / 2
Digital signals (digital input)		4 / 4
Data when using the AI as digital input		
Input	time delay	8 ms typically, configurable from 0.1 up to 32 ms
	signal voltage	24 V DC
Outputs, single configurable as		
Possible configuration per AO		●
-10...+10 V		●
0...20 mA / 4...20 mA		●
Output resistance (load) when used as current output		0...500 Ω
Output loading capability when used as voltage output		±10 mA max.
Potential isolation		
Per module		●
Process voltage UP		
Nominal voltage		24 V DC
Maximum ripple		5 %
Current consumption on UP		
Min. typ. (module alone)		0.070 A
Max. typ. (min. + loads)		0.070 A + load
Reverse polarity protection		●
Fuse for process voltage UP		10 A miniature fuse
Approvals		See detailed page 168 or www.abb.com/plc

AC500-XC

Technical data

DC541-CM-XC interrupt I/O and fast counter module

In the operating mode counter, the channels can be configured as follows:

Input, Output, 32-bit up/down counter (uses C0...C3) as a 32-bit counter without limit, 32-bit periodic counter as a 32-bit counter with a limit, limiter for a 32-bit counter (limit channel 0), 32-bit up counter (forward counter) with the frequencies 50 kHz, 5 kHz and 2.5 kHz, pulse-width modulation (PWM) with a resolution of 10 kHz, time and frequency measurement, frequency output.

Type	DC541-CM-XC	
Number of channels per module		
Configurable channels DC (configurable as inputs or outputs)	8	
Additional configuration of channels as		
Fast counter	Yes	
Connection via CPU terminal base. Occupies one communication module slot	●	
Digital inputs		
Input signal voltage characteristic acc. to EN 61132-2	24 V DC Type 1	
0 signal	-3...+5 V DC	
Undefined signal state	5...15 V DC	
1 signal	5...30 V DC	
Input time delay (0 -> 1 or 1 -> 0)	20 µs	
	Clamp to clamp - 300 µs with interrupt task	
Input current per channel		
At input voltage	24 V DC	5 mA typically
	5 V DC	> 1 mA
	15 V DC	> 5 mA
	30 V DC	< 8 mA
Digital outputs		
Transistor outputs 24 V DC, 0.5 A	●	
Readback of output	●	
Switching of 24 V load	●	
Output voltage at signal state 1	Process voltage UP minus 0.8 V	
Output current		
Nominal current per channel	500 mA at UP = 24 V	
Maximum (total current of all channels)	8 A	
Residual current at signal state 0	< 0.5 mA	
Demagnetization when switching off inductive loads	by internal varistors	
Potential isolation		
Per module	●	
Voltage supply for the module	Internally via backplane bus	

5

Interrupt I/O table

Configuration as	Configuration for channel no.					Max. no. of channels for this function	Remarks and notes regarding possible alternative combinations of the remaining channels (a and b)	
	Chan. 0	Chan. 1	Chan. 2	Chan. 3	Chan. 4-7			
Mode 1: Interrupt functionality								
Interrupt	Digital input	1	1	1	1	4	8	Each channel can be configured individually as interrupt input or output
	Digital output	1	1	1	1	4	8	
Mode 2: Counting functionality								
Digital I/Os PWM (1)	Digital input	1	1	1	1	4	8	Usual input
	Digital output	1	1	1	1	4	8	Usual output
	PWM, resolution 10 kHz	1	1	1	1	4	8	Outputs and pulsed signal with and adjustable on-off ratio

(1) Counter and fast counter data available on technical documentation.

AC500-XC

Technical data

AC500-XC communication modules

- Up to 4 communications modules can be used on an AC500-XC CPU
- No external power supply required.

Type	CM572-DP-XC	CM597-ETH-XC	CM578-CN-XC	CM588-CN-XC	CM579-PNIO-XC	CM589-PNIO-XC
Communication interfaces						
RJ45	–	● (x2)(1)	–	–	● (x2)(1)	● (x2)(2)
RS-232 / 485	–	–	–	–	–	–
Terminal blocks	–	–	●	●	–	–
Sub-D socket	●	–	–	–	–	–
Protocols	PROFIBUS® DP master V0/V1	Ethernet (TCP/IP, UDP/IP, Modbus TCP)	CANopen® master	CANopen® slave	PROFINET® IO controller	PROFINET® IO device
CPU interface	8 kB Dual-port memory	8 kB Dual-port memory	8 kB Dual-port memory	8 kB Dual-port memory	8 kB Dual-port memory	8 kB Dual-port memory
Transfer Rate	9.6 kbit/s to 12 Mbit/s	10/100 Mbit/s	10 kbit/s to 1 Mbit/s	10 kbit/s to 1 Mbit/s	10/100 Mbit/s	10/100 Mbit/s
Co-processor	Communication processor	Communication processor netX	Communication processor	Communication processor netX 100	Communication processor netX 100	Communication processor netX 100
Additional features	Multi master functionality Max. Number of subscribers: - 126 (V0) - 32 (V1)	BOOTP DHCP	CAN 2.0A CAN 2.0B CANopen®	NMT slave PDO SDO server Heartbeat Nodeguard	RTC - Real-Time Cyclic protocol, Class 1 RTA - Real-Time Acyclic protocol DCP Discovery and Configuration Protocol CL-RPC - Connectionless Remote Procedure Call	RTC - Real-Time Cyclic protocol, Class 1 RTA - Real-Time Acyclic protocol DCP Discovery and Configuration Protocol LLDP - Link Layer Discovery Protocol

(1) 10/100 Mbit/s, full/half duplex with auto-sensing, 2-port switch integrated.

AC500-XC

Technical data

Communication interface modules

For all modules: max cable length for connected process signals is 1000 m for shielded cable and 600 m for unshielded ones.
For all Input modules, the signal resolution for channel configuration is: -10...+10 V: 12 bits + sign; 0...10 V, 0...20 mA, 4...20 mA: 12 bits.
Temperature: 0.1 °C.

Type	DC551-CS31-XC	CI590-CS31-HA-XC (1)	CI592-CS31-XC
Communication Interface			
Protocol	Proprietary CS31 bus protocol on RS485 interface		
ID configuration	Per rotary switches on front face from 00d to 99d		
Field bus connection on TUs	CS31 field bus, via terminal / redundant for CI590-CS31-HA-XC on TU552-CS31-XC		
Number of Channels per Module			
Digital			
inputs	8	–	8
outputs	–	–	–
Analog			
inputs	–	–	4
outputs	–	–	2
Digital configurable channels DC (configurable as inputs or outputs)	16	16	8
Additional configuration of channels as			
Fast counter	Configuration of max. 2 channels per module		
Occupies max. 1 DO or DC when used as counter	●	●	●
Connection			
Via terminal base TU5xx	●	●	●
Local I/O extension			
Max. number of extension modules	max. 7 x S500 extension modules, up to 31 stations with up to 120 DI/120 DOs or up to 32 AIs/ 32AOs per station		
Digital inputs			
Input	signal voltage	24 V DC	
	characteristic acc. to EN 61132-2	Type 1	
0 signal		-3...+5 V DC	
Undefined signal state		5...15 V DC	
1 signal		15...30 V DC	
Residual ripple, range for	0 signal	-3...+5 V DC	
	1 signal	15...30 V DC	
Input time delay (0 -> 1 or 1 -> 0)		8 ms typically, configurable from 0.1 up to 32 ms	
Digital outputs			
Transistor outputs 24 V DC, 0.5 A	●		
Readback of output	●		
Outputs, supplied via process voltage UP	●		
Switching of 24 V load	●		
Output voltage at signal state 1	Process voltage UP - 0.8 V		
Output current			
Nominal current per channel	500 mA at UP = 24 V DC		
Maximum (total current of all channels)	8 A	8 A	4 A
Residual current at signal state 0	< 0.5 mA		
Demagnetization when switching off inductive loads	By internal varistors		
Analog inputs AI			
Signal configuration per AI	Max. number per module and with regard to the configuration: AIs / Measuring points		
0...10 V / -10...+10 V	–	●	
0...20 mA / 4...20 mA	–	4 / 4	
RTD using 2/3 wire needs 1/2 channel(s)	–	4 / 4	
0...10 V using differential inputs, needs 2 channels	–	4 / 2	
-10...+10 V using differential inputs, needs 2 channels	–	4 / 2	
Digital signals (digital input)	–	4 / 4	
Data when using the AI as digital input			
Input	time delay	–	8 ms typically, configurable from 0.1 up to 32 ms
	signal voltage	–	24 V DC

(1) Dedicated to High Availability. Not compatible with S500-eCo I/O modules.

AC500-XC

Technical data

Communication interface modules

Type	DC551-CS31-XC	CI590-CS31-HA-XC (1)	CI592-CS31-XC
Outputs, single configurable as			
Possible configuration per AO	-	-	●
-10...+10 V	-	-	●
0...20 mA / 4...20 mA	-	-	●
Output			0...500 Ω
resistance (load) when used as current output	-	-	
loading capability when used as voltage output	-	-	±10 mA max.
Potential isolation			
Per module	●	●	●
Between fieldbus interface against the rest of the module	●	●	●
Voltage supply for the module	By external 24 V DC voltage via terminal UP		
Process voltage UP			
Nominal voltage	24 V DC		
Maximum ripple	5 %		
Current consumption on UP			
Min. typ. (module alone)	0.100 A	0.100 A	0.070 A
Max. typ. (min. + loads)	0.100 A + load	0.100 A + load	0.070 A + load
Reverse polarity protection	●		
Fuse for process voltage UP	10 A miniature fuse		
Approvals	See detailed page 168 or www.abb.com/plc		

(1) Dedicated to High Availability.

AC500-XC

Technical data

PROFIBUS®-DP modules

Type	CI541-DP-XC	CI542-DP-XC
Communication Interface		
Protocol	PROFIBUS® DP (DP-V0 and DP-V1 slave)	
ID configuration	Per rotary switches on front face from 00h to FFh	
Field bus connection on terminal units	Sub-D 9 poles on TU510-XC or TU518-XC with baud rate up to 1Mbaud	
Number of Channels per Module		
Digital	inputs	8
	outputs	8
Analog	inputs	4
	outputs	2
Digital configurable channels DC (configurable as inputs or outputs)		8
Additional configuration of channels as		
Fast counter (onboard I/O)	Configuration of max. 2 DI channels per module	
Occupies max 1 DO or DC when used as counter	●	●
Connection		
Local I/O extension	●	
Max. number of extension modules	max. 10 x S500 extension modules, fast counter from digital IO modules can be also used	
Via terminal base TU5xx	●	●
Digital inputs		
Input	signal voltage	24 V DC
	characteristic acc. to EN 61132-2	Type 1
0 signal		-3...+5 V DC
Undefined signal state		5...15 V DC
1 signal		15...30 V DC
Residual ripple, range for	0 signal	-3...+5 V DC
	1 signal	15...30 V DC
Input time delay (0 -> 1 or 1 -> 0)	8 ms typically, configurable from 0.1 up to 32 ms	
Digital outputs		
Transistor outputs 24 V DC, 0.5 A	●	
Readback of output	-	● (on DC outputs)
Outputs, supplied via process voltage UP	●	
Switching of 24 V load	●	
Output voltage at signal state 1	Process voltage UP - 0.8 V	
Output current		
Nominal current per channel	500 mA at UP = 24 V DC	
Maximum (total current of all channels)	8 A	
Residual current at signal state 0	< 0.5 mA	
Demagnetization when switching off inductive loads	By internal varistors	
Analog Inputs AI		
Signal configuration per AI	Max. number per module and with regard to the configuration: AIs / Measuring points	
0...10 V / -10...+10 V	4	-
0...20 mA / 4...20 mA	4 / 4	-
RTD using 2/3 wire needs 1/2 channel(s)	4 / 2	-
0...10 V using differential inputs, needs 2 channels	4 / 2	-
-10...+10 V using differential inputs, needs 2 channels	4 / 2	-
Digital signals (digital input)	4 / 4	-
Data when using the AI as digital input		
Input	time delay	8 ms typically, configurable from 0.1 up to 32 ms
	signal voltage	24 V DC
Outputs, single configurable as		
Possible configuration per AO	●	
-10...+10V	●	
0...20 mA / 4...20 mA	●	
Output	resistance (load) when used as current output	0...500 Ω
	loading capability when used as voltage output	±10 mA max.

AC500-XC

Technical data

PROFIBUS®-DP modules

Type	CI541-DP-XC	CI542-DP-XC
Potential isolation		
Per module	●	●
Between fieldbus interface against the rest of the module	●	●
Between the channels		
input	–	–
output	–	–
Voltage supply for the module	By external 24 V DC voltage via terminal UP	
Process voltage UP		
Nominal voltage	24 V DC	
Maximum ripple	5 %	
Current consumption on UP		
Min. typ. (module alone)	0.260 A	
Max. typ. (min. + loads)	0.260 A + load	
Reverse polarity protection	●	
Fuse for process voltage UP	10 A miniature fuse	
Approvals	See detailed page 168 or www.abb.com/plc	

5

AC500-XC

Technical data

CANopen® modules

Type	CI581-CN-XC	CI582-CN-XC	
Communication interface			
Protocol	CANopen® slave, DS401 profile selectable using rotary switches		
ID configuration	Per rotary switches on front face for CANopen® ID node from 00h to 7Fh and 80h to FFh for CANopen® DS401 profile		
Field bus connection on terminal units	Terminal blocks on TU518-XC		
Number of channels per module			
Digital	inputs	8	8
	outputs	8	8
Analog	inputs	4	-
	outputs	2	-
Digital configurable channels DC (configurable as inputs or outputs)		-	8
Additional configuration of channels as			
Fast counter (onboard I/O)	Configuration of max. 2 DI channels per module		
Occupies max. 1 DO or DC when used as counter	●	●	
Connection			
Local I/O extension	●		
Max. number of extension modules	max. 10 x S500-XC extension modules		
Via terminal unit TU5xx	●	●	
Digital inputs			
Input	signal voltage characteristic acc. to EN 61132-2	24 V DC Type 1	
0 signal		-3...+5 V DC	
Undefined signal state		5...15 V DC	
1 signal		15...30 V DC	
Residual ripple, range for	0 signal	-3...+5 V DC	
	1 signal	15...30 V DC	
Input time delay (0 -> 1 or 1 -> 0)	8 ms typically, configurable from 0.1 up to 32 ms		
Digital outputs			
Transistor outputs 24 V DC, 0.5 A	●		
Readback of output	-	● (on DC outputs)	
Outputs, supplied via process voltage UP	●		
Switching of 24 V load	●		
Output voltage at signal state 1	Process voltage UP - 0.8 V		
Output current			
Nominal current per channel	500 mA at UP = 24 V DC		
Maximum (total current of all channels)	8 A		
Residual current at signal state 0	< 0.5 mA		
Demagnetization when switching off inductive loads	By internal varistors		
Analog Inputs AI			
Signal configuration per AI	Max. number per module and with regard to the configuration: AIs / Measuring points		
0...10 V / -10...+10 V	4 / 4	-	
0...20 mA / 4...20 mA	4 / 4	-	
RTD using 2/3 wire needs 1/2 channel(s)	4 / 2	-	
0...10 V using differential inputs, needs 2 channels	4 / 2	-	
-10...+10 V using differential inputs, needs 2 channels	4 / 2	-	
Digital signals (digital input)	4 / 4	-	
Data when using the AI as digital input			
Input	time delay	8 ms typically, configurable from 0.1 up to 32 ms	-
	signal voltage	24 V DC	-
Outputs, single configurable as			
Possible configuration per AO	●		-
-10...+10 V	●		-
0...20 mA / 4...20 mA	●		-
Output	resistance (load) when used as current output	0...500 Ω	-
	loading capability when used as voltage output	±10 mA max.	-

AC500-XC

Technical data

CANopen® modules

Type	CI581-CN-XC	CI582-CN-XC
Potential isolation		
Per module	●	●
Between fieldbus interface against the rest of the module	●	●
Between the channels		
input	–	–
output	–	–
Voltage supply for the module	By external 24 V DC voltage via terminal UP	
Process voltage UP		
Nominal voltage	24 V DC	
Maximum ripple	5 %	
Current consumption on UP		
Min. typ. (module alone)	0.260 A	
Max. typ. (min. + loads)	0.260 A + load	
Reverse polarity protection	●	
Fuse for process voltage UP	10 A miniature fuse	
Approvals	See detailed page 168 or www.abb.com/plc	

5

AC500-XC

Technical data

PROFINET® IO RT device modules

Type	CI501-PNIO-XC	CI502-PNIO-XC	CI504-PNIO-XC	CI506-PNIO-XC
Communication interface				
Ethernet Interface				
Main protocol	PROFINET® IO RT device			
ID Device configuration	By rotary switch on the front side, from 00h to FFh			
Ethernet connection on terminal units	2 x RJ45 with switch functionality for simple daisy chain on TU508-ETH-XC or TU520-ETH-XC			
Gateway Interface				
Gateway to	-	-	3 x RS232/RS422/RS485 ASCII serial interfaces	CAN / CANopen® Master + 2 x RS232/RS422/RS485 ASCII serial interfaces
Fieldbus Protocol used				
CAN physical interface	-	-	-	CAN 2A/2B Master - CANopen® Master (1) 1 x 10 poles pluggable spring connector
Baudrate	-	-	-	Baudrate up to 1 MBit/s, Support for up to 126 CANopen® Slaves
Serial interface				
Protocol used	-	-	3 x RS232 / RS422 or RS485	2 x RS232 / RS422 or RS485
Baudrate	-	-	ASCII	ASCII
Fieldbus or serial connection on TUs	-	-	Configurable from 300 bit/s to 115200 bit/s	3 x pluggable terminal blocks with spring on TU520-ETH
Number of channels per module				
Digital	inputs	8	8	-
	outputs	8	8	-
Analog	inputs	4	-	-
	outputs	2	-	-
Digital configurable channels DC (configurable as inputs or outputs)		-	8	-
Additional configuration of channels as				
Connection via terminal unit TU5xx	-	-	●	●
Fast counter (onboard I/O)	Configuration of max. 2 DI channels per module		-	-
Occupies max. 1 DO or DC when used as counter	●	-	-	-
Connection				
Local I/O extension	●	-	●	●
Max. number of extension modules	max. 10 x S500-XC extension modules. Fast counter from digital IO modules can be also used.		Valid for CI501-XC, 502-XC, 504-XC and 506-XC. All modules can have extension up to 10 modules	
Digital inputs				
Input	signal voltage	24 V DC		
	characteristic acc. to EN 61132-2	Type 1		
0 signal	-3...+5 V DC			
Undefined signal state	5...15 V DC			
1 signal	15...30 V DC			
Residual ripple, range for	0 signal	-3...+5 V DC		
	1 signal	15...30 V DC		
Input time delay (0 -> 1 or 1 -> 0)	8 ms typically, configurable from 0.1 up to 32 ms			-
Digital outputs				
Transistor outputs 24 V DC, 0.5 A	●	-	-	-
Readback of output	-	● (on DC outputs)	-	-
Outputs, supplied via process voltage UP	●	-	-	-
Switching of 24 V load	●	-	-	-
Output voltage at signal state 1	Process voltage UP - 0.8 V			-
Output current				
Nominal current per channel	500 mA at UP = 24 V DC			-
Maximum (total current of all channels)	8 A			-
Residual current at signal state 0	< 0.5 mA			-
Demagnetization when switching off inductive loads	By internal varistors			-

(1) Not simultaneously.

AC500-XC

Technical data

PROFINET® IO RT device modules

Type	CI501-PNIO-XC	CI502-PNIO-XC	CI504-PNIO-XC	CI506-PNIO-XC
Analog inputs AI				
Max. number per module and with regard to the configuration: AIs / Measuring points				
Signal configuration per AI	4	-	-	-
0...10 V / -10... +10 V	4 / 4	-	-	-
0...20 mA / 4...20 mA	4 / 4	-	-	-
RTD using 2/3 wire needs 1/2 channel(s)	4 / 2	-	-	-
0...10 V using differential inputs, needs 2 channels	4 / 2	-	-	-
-10...+10 V using differential inputs, needs 2 channels	4 / 2	-	-	-
Digital signals (digital input)	4 / 4	-	-	-
Data when using the AI as digital input				
Input	time delay	8 ms typically, configurable from 0.1 up to 32 ms	-	-
	signal voltage	24 V DC	-	-
Outputs, single configurable as				
Possible configuration per AO				
-10...+10 V	●	-	-	-
0...20 mA / 4...20 mA	●	-	-	-
Output	resistance (load) when used as current output	0...500 Ω	-	-
	loading capability when used as voltage output	±10 mA max.	-	-
Potential isolation				
Per module	●	●	●	●
Between Ethernet interface against the rest of the module	●	●	●	●
Voltage supply for the module	By external 24 V DC voltage via terminal UP			
Process voltage UP				
Nominal voltage	24 V DC			
Maximum ripple	5 %			
Current consumption on UP				
	min. typ. (module alone)	0.260 A	0.150 A	
	max. typ. (min. + loads)	0.260 A + load	0.150 A + load	
Reverse polarity protection	●			
Fuse for process voltage UP	10 A miniature fuse			
Approvals	See detailed page 168 or www.abb.com/plc			

AC500-XC

Technical data

CS31 functionality

	AC500-XC CPU with integrated CS31 interface	S500 I/O with communication interface DC551-CS31-XC CI590-CS31-HA-XC CI592-CS31-XC
Master	Yes, at COM1	-
Slave	No	Yes / Redundant for CI590-CS31-HA-XC
Protocols supported	ABB CS31 protocol	
Diagnosis		
Error indication	On LCD display of the CPU	Via module LEDs
Online diagnosis	Yes	
Error code	Errors are recorded in the diagnosis system of the CPU	
Associated function blocks	Yes	
Physical layer		
Connection	Plug at COM1	Screw-type or spring-type terminals
Baud rate	187.5 kbit/s	
Distance	AC500-XC: up to 500 m; up to 2000 m using a repeater	
Max. number of modules on fieldbus	31 modules max. Please note: The CS31 bus interface occupies one or two module addresses (if counters are configured onboard or if the module is a mixed digital analog module). Depending on the configuration, or if the module contains also mixed digital analog I/O, connected extension modules can occupy further module addresses.	
Configuration		
Station address configuration	No	Using rotary switches (99 max.)

AC500-XC

Technical data

Digital I/O modules, "Fast Counter" operating modes. Not applicable for DC541-XC (1)

Operating mode, configured in the user program of the AC500-XC		Occupied inputs DI or DC	Occupied outputs DO or DC	Maximum counting frequency kHz
0	No counter	0	0	–
1	One count-up counter with "end value reached" indication	1	1	50
2	One count-up counter with "enable" input and "end value reached" indication	2	1	50
3	Two up/down counters	2	0	50
4	Two up/down counters with 1 counting input inverted	2	0	50
5	One up/down counter with "dynamic set" input	2	0	50
6	One up/down counter with "dynamic set" input	2	0	50
7	One up/down counter with directional discriminator For synchro transmitters using two counting pulses with an offset of 90° (track A and B)	2	0	50
8	–	0	0	–
9	One up/down counter with directional discriminator and double evaluation For synchro transmitters using two counting pulses with an offset of 90° towards each other (track A and B)	2	0	30
10	One up/down counter with directional discriminator and fourfold evaluation For synchro transmitters using two counting pulses with an offset of 90° towards each other (track A and B)	2	0	15

(1) See technical documentation for details.

AC500-XC

System data

Environmental conditions

Process and supply voltages

24 V DC	Process and supply voltage	24 V DC (-25 %, +30 % inclusive ripple)
	Absolute limits	18 ... 31.2 V inclusive ripple
	Ripple	< 10 %
	Protection against reverse polarity	yes
Allowed interruptions of power supply	DC supply	Interruption < 10 ms, time between 2 interruptions > 1s, PS2

Important: Exceeding the maximum process or supply voltage (< -35 V DC and > + 35 V DC) could lead to unrecoverable damage of the system. For the supply of the modules, power supply units according to PELV or SELV specifications must be used. The creepage distances and clearances meet the requirements of the overvoltage category II, pollution degree 2.

Temperature

Operating	-40 ... +70 °C	
	-40 ... -30 °C	Proper start-up of system; technical data not guaranteed
	-40 ... 0 °C	Due to the LCD technology, the display might not be readable
	-40 ... +40 °C	vertical mounting of modules possible, output load limited to 50% per group with the following deratings:
	+60 ... +70 °C	System is limited to max. 2 Communication Modules per Terminal Base Applications certified for cULus up to 60 °C Digital inputs: maximum number of simultaneously switched on input channels limited to 75 % per group (e.g. 8 channels => 6 channels) Digital outputs: output current maximum value (all channels together) limited to 75 % per group (e.g. 8 A => 6 A) Analog outputs only if configured as voltage output: maximum total output current per group is limited to 75 % (e.g. 40 mA => 30 mA) Analog outputs only if configured as current output: maximum number of simultaneously used output channels limited to 75 % per group (e.g. 4 channels => 3 channels)
Storage / Transport	-40 ... +85 °C	

Humidity

Operating / Storage	100 % r. H. with condensation
---------------------	-------------------------------

Air pressure

Operating	-1000 m 4000 m (1080 hPa ... 620 hPa) >2000 m (<795 hPa): max. operating temperature must be reduced by 10 K (e.g. 70 °C to 60°C)
-----------	---

Immunity to corrosive gases

Operating	Yes, according to: ISA S71.04.1985 Harsh group A, G3/GX IEC 60721-3-3 3C2 / 3C3
-----------	---

Immunity to salt mist

Operating	Yes, horizontal mounting only, according to: IEC 60068-2-52 severity level 1
-----------	---

Note: Unused communication sockets (RJ45, Sub-D, FBP) must be covered with TA535 Protective Caps for XC devices in case of salt mist environments.

Electromagnetic Compatibility

Radiated emission (radio disturbances)	Yes, according to: CISPR 16-2-3
Conducted emission (radio disturbances)	Yes, according to: CISPR 16-2-1, CISPR 16-1-2
Electrostatic discharge (ESD)	Yes, according to: IEC 61000-4-2, zone B, criterion B
Fast transient interference voltages (burst)	Yes, according to: IEC 61000-4-4, zone B, criterion B
High energy transient interference voltages (surge)	Yes, according to: IEC 61000-4-5, zone B, criterion B
Influence of radiated disturbances	Yes, according to: IEC 61000-4-3, zone B, criterion A
Influence of line-conducted interferences	Yes, according to: IEC 61000-4-6, zone B, criterion A
Influence of power frequency magnetic fields	Yes, according to: IEC 61000-4-8, zone B, criterion A

Note: In order to prevent malfunctions, it is recommended that the operating personnel discharge themselves prior to touching communication connectors or perform other suitable measures to reduce effects of electrostatic discharges. Unused sockets for Communication Modules on Terminal Bases must be covered with TA524 Dummy Communication Module. I/O-Bus connectors must not be touched during operation.

AC500-XC

System data

Mechanical data

Wiring method		Spring terminals
Degree of protection		IP20
Vibration resistance		Yes, according to: IEC 61131-2, IEC 60068-2-6, IEC 60068-2-64
Shock resistance		Yes, according to: IEC 60068-2-27
Assembly position		Horizontal Vertical (no application in salt mist environment)
Assembly on DIN rail	DIN rail type	According to IEC 60715: 35 mm, depth 7.5 mm or 15 mm
Assembly with screws	Screw diameter	4 mm
	Fastening torque	1.2 Nm

Environmental Tests

Storage		IEC 60068-2-1 Test Ab: cold withstand test -40 °C / 16 h IEC 60068-2-2 Test Bb: dry heat withstand test +85 °C / 16 h
Humidity		IEC 60068-2-30 Test Db: Cyclic (12 h / 12 h) Damp-Heat Test 55 °C, 93 % r. H. / 25 °C, 95 % r. H., 6 cycles IEC 60068-2-78, Stationary Humidity Test: 40 °C, 93 % r. H., 240 h
Insulation Test		IEC 61131-2
Vibration resistance		IEC 61131-2 / IEC 60068-26: 5 Hz ... 500 Hz, 2 g (with SD Memory Card inserted) IEC 60068-2-64: 5 Hz ... 500 Hz, 4 g rms
Shock resistance		IEC 60068-2-27: all 3 axes 15 g, 11 ms, half-sinusoidal

EMC Immunity

Electrostatic discharge (ESD)		Electrostatic voltage in case of air discharge: 8 kV Electrostatic voltage in case of contact discharge: 6 kV
Fast transient interference voltages (burst)		Supply voltage units (DC): 4 kV Digital inputs/outputs (24 V DC): 2 kV Analog inputs/outputs: 2 kV Communication lines shielded: 2 kV I/O supply (DC-out): 2 kV
High energy transient interference voltages (surge) (1)		Supply voltage units (DC): 1 kV CM / 0.5 kV DM Digital inputs/outputs (24 V DC): 1 kV CM / 0.5 kV DM Analog inputs/outputs: 1 kV CM / 0.5 kV DM Communication lines shielded: 1 kV CM I/O supply (DC-out): 0.5 kV CM / 0.5 kV DM
Influence of radiated disturbances		Test field strength: 10 V/m
Influence of line-conducted interferences		Test voltage: 10 V
Power frequency		30 A/m 50 Hz
Magnetic fields		30 A/m 60 Hz

(1) CM = Common Mode, DM = Differential Mode.

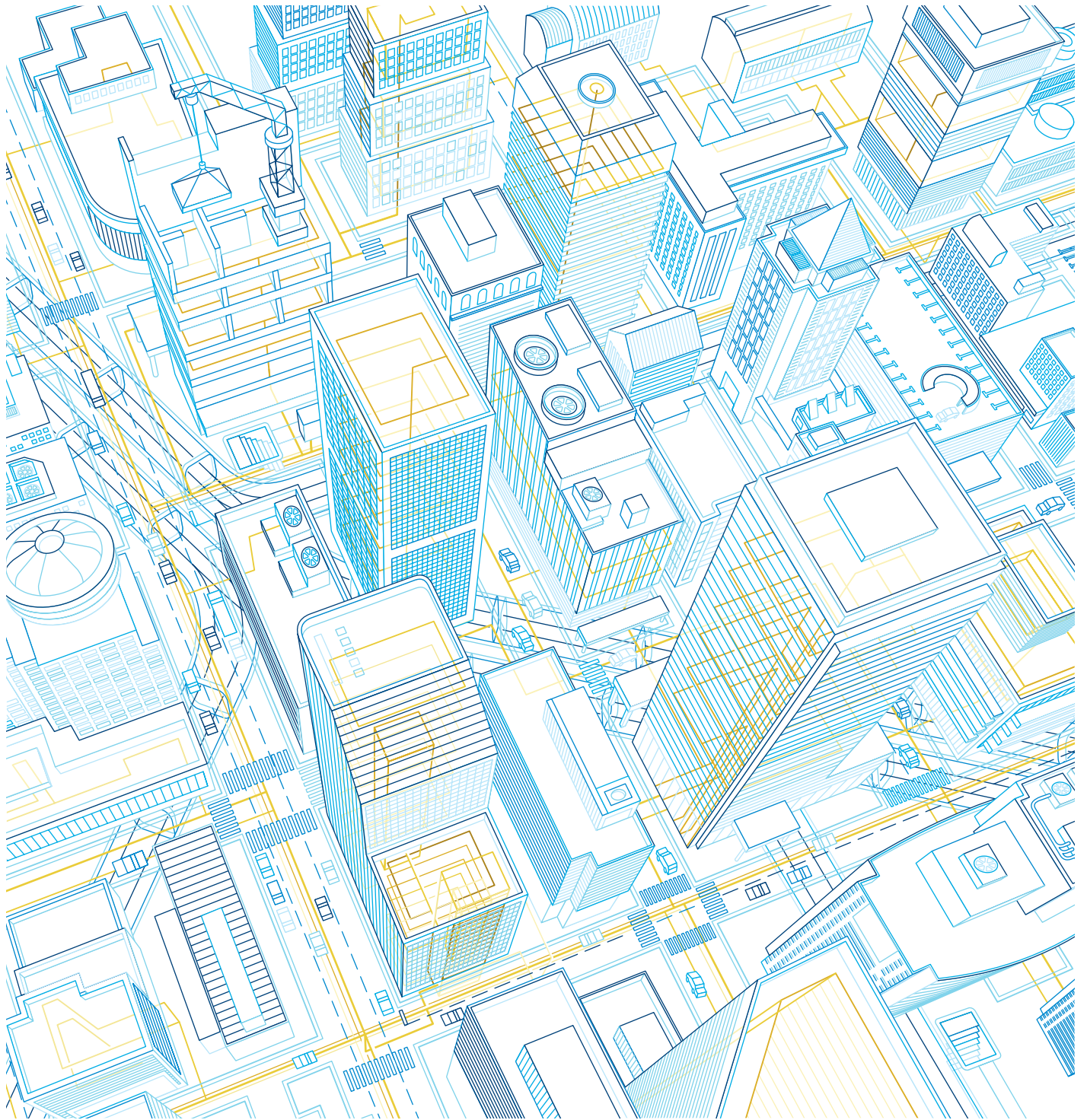

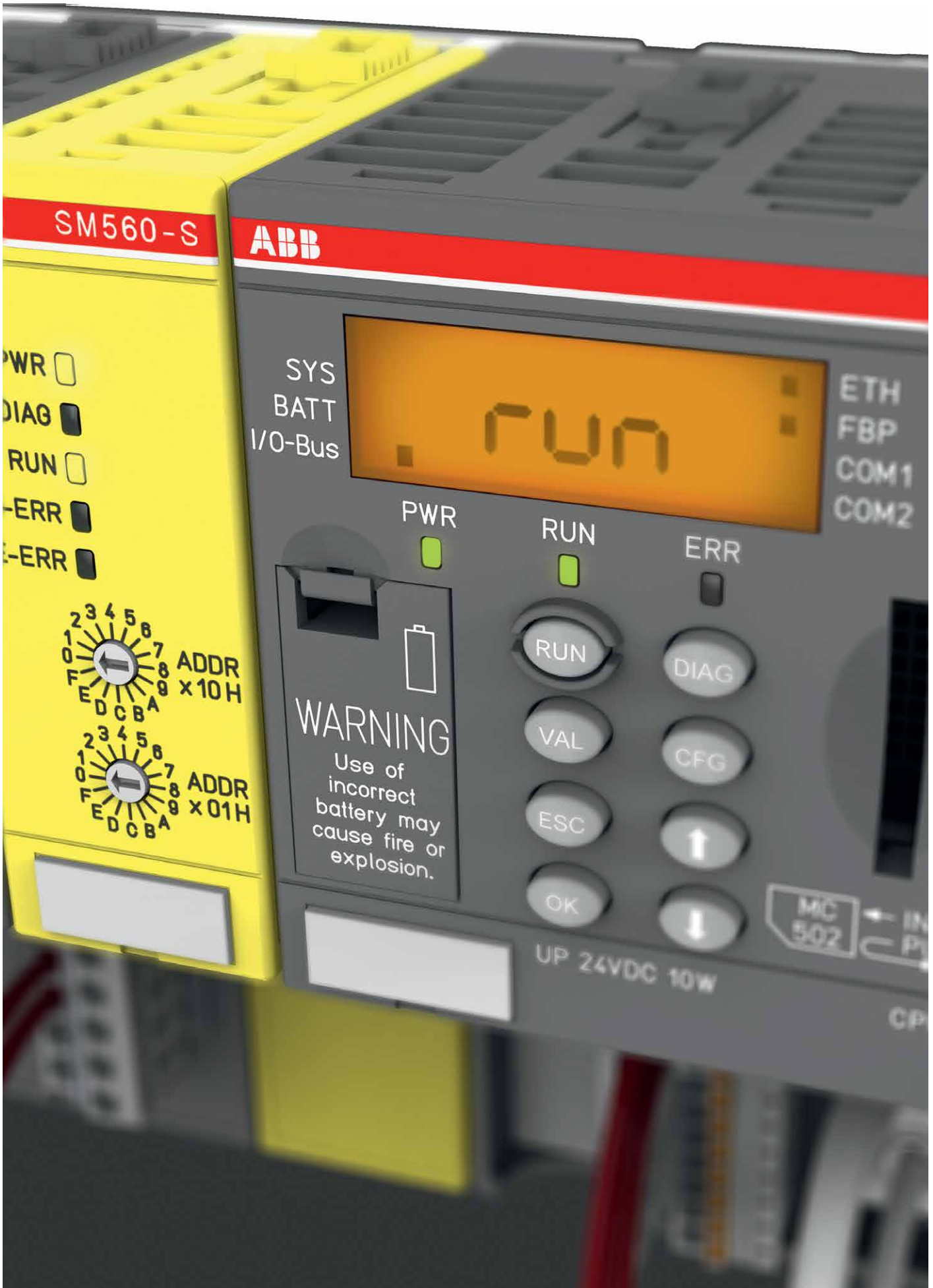

AC500-S

Functional Safety PLC

Key features	6/120
Functional Safety PLC from ABB	6/121
Functional Safety and extreme conditions PLC from ABB	6/122
Technical data	6/123
System data	6/126

AC500-S

Key features

Easy integration: Simple expansion of a non-safety ABB PLC with safety functions.

One common diagnostic system for safety and non-safety CPUs. eXtreme Conditions (-XC) version is available.

6

PROFINET®/PROFIsafe® interface for decentralized safety I/Os, safe position and speed monitoring as well as triggering of safety drive functions.



Easy implementation of flexible configuration concept (one safety program for various machine types). Safety CPU can be configured to work even if non-safety CPU is in STOP mode.

Automation Builder productivity suite providing integrated support of ST, Ladder (LD) and Function Block Diagram (FBD) programming. Trigonometric functions are supported for easy implementation of complex kinematic tasks.

AC500-S

Functional Safety PLC from ABB



SM560-S

Safety CPU

Description	User program memory	Type	Order code	Weight (1 pce) kg
	MB			
Safety CPU module	1	SM560-S	1SAP280000R0001	0.100

S500 Safety I/O

Description	Input signal		Output signal	Type	Order code	Weight (1 pce) kg
	SIL2	SIL3	SIL3			
Safety digital input module	16	8	-	DI581-S	1SAP284000R0001	0.130
Safety digital input / output module	8	4	8	DX581-S	1SAP284100R0001	0.130
Safety analog input module	4	2	-	AI581-S	1SAP282000R0001	0.130



DI581-S

S500 Safety terminal unit

Description	Type	Order code	Weight (1 pce) kg
Spring terminal unit for safety I/O modules	TU582-S	1SAP281200R0001	0.200



TU582-S

Software

Description	Type	Order code	Weight (1 pce) kg
Licence enabling package for AC500-S Safety PLC programming	PS501-S	1SAP198000R0001	0.100

AC500-S-XC

Functional Safety and extreme conditions PLC from ABB



SM560-S-XC

Safety XC CPU

Description	User program memory	Type	Order code	Weight (1 pce) kg
	MB			
Safety CPU module	1	SM560-S-XC	1SAP380000R0001	0.100

S500-XC Safety I/O

Description	Input signal		Output signal	Type	Order code	Weight (1 pce) kg
	SIL2	SIL3	SIL3			
Safety digital input module	16	8	-	DI581-S-XC	1SAP484000R0001	0.130
Safety digital input / output module	8	4	8	DX581-S-XC	1SAP484100R0001	0.130
Safety analog input module	4	2	-	AI581-S-XC	1SAP482000R0001	0.130

S500-XC Safety terminal unit

Description	Type	Order code	Weight (1 pce) kg
Spring terminal unit for safety I/O modules	TU582-S-XC	1SAP481200R0001	0.200

6



DI581-S-XC



TU582-S-XC

AC500-S and AC500-S-XC

Technical data

Safety CPUs

Type		SM560-S / SM560-S-XC
Performance level		PL e (ISO 13849)
Safety	integrity level	SIL3 (IEC 61508: 2010, IEC 62061)
	protocol	PROFIsafe® V2 via PROFINET®
Program memory flash EPROM and RAM		1 MB
Integrated data memory		1 MB thereof 120 KB saved

Cycle time for 1 instruction

Binary	0.05 µs
Word	0.06 µs
Floating point	0.5 µs

Max. number of centralized inputs/outputs

Max. nb. of safety extension modules on I/O bus		up to max. 10
Digital	inputs	160 (SIL2) / 80 (SIL3)
	outputs	80 (SIL3)
Analog	inputs	40 (SIL2) / 20 (SIL3)
Max. number of decentralized inputs/outputs		On PROFINET®: up to 128 stations with up to 10 safety extension modules

Program execution

Cyclical	●
User program protection by password	●

Interfaces

Ethernet	Via AC500 CPU or PROFINET® coupler
COM	Via AC500 CPU
Programming	Via AC500 CPU

Approvals	CE, cUL, UL, C-Tick
------------------	---------------------

AC500-S and AC500-S-XC

Technical data

S500 and S500-XC Safety I/O

Type	DI581-S / DI581-S-XC	DX581-S / DX581-S-XC	AI581-S / AI581-S-XC
Performance Level	PL e (ISO 13849)		
Safety Integrity Level	SIL3		
Safety protocol	PROFIsafe® V2 via PROFINET® (IEC 61508: 2010, IEC 62061)		

Digital inputs

Number of channels per module	16 (SIL2) / 8 (SIL3)	8 (SIL2) / 4 (SIL3)	-
Input signal voltage	24 V DC	24 V DC	-
Frequency range	65 Hz	65 Hz	-
Input characteristic acc. to EN61131-2	Type 1	Type 1	-
0 signal	-3...+5 V DC	-3...+5 V DC	-
Undefined signal state	5...15 V DC	5...15 V DC	-
1 signal	15...30 V DC	15...30 V DC	-
Input time delay (0 -> 1 or 1 -> 0)	Input filter configurable from 1, 2, 5...500 ms	Input filter configurable from 1, 2, 5...500 ms	-
Test pulse outputs	8	4	-

Input current per channel

At input voltage	24 V DC / 7 mA typically	24 V DC / 7 mA typically	-
	5 V DC / < 1 mA	5 V DC / < 1 mA	-
	15 V DC / > 4 mA	15 V DC / > 4 mA	-
	30 V DC / < 8 mA	30 V DC / < 8 mA	-

Digital outputs

Number of channels per module	-	8 (SIL3)	-
Transistor outputs 24 V DC, 0.5 A	-	●	-
Switching of 24 V load	-	●	-

Output current

Nominal current per channel	-	500 mA at UP = 24 V	-
Maximum (total current of all channels)	-	4 Amp. / 500 mA / channel	-
Residual current at signal state 0	-	< 0.5 mA	-
Demagnetization when switching off inductive loads	-	By internal suppressor diodes	-

Switching frequency

Short-circuit / overload proofness	-	●	-
For inductive load	-	On request	-
For lamp load	-	On request	-
Proofness against reverse feeding of 24 V signals	-	●	-

AC500-S and AC500-S-XC

Technical data

S500 and S500-XC Safety I/O

Type	DI581-S / DI581-S-XC	DX581-S / DX581-S-XC	AI581-S / AI581-S-XC
Analog inputs			
Number of channels per module	-	-	4 (SIL2) / 2 (SIL3)
Input resistance per channel	-	-	125 Ohm
Time constant of the input filter	-	-	10 ms
Conversion cycle	-	-	0.33 ms
Overvoltage protection	-	-	-
Signal resolution for channel configuration			
0...20 mA, 4...20 mA	-	-	14 bits
Process voltage UP			
Nominal voltage	24 V DC		
Maximum ripple	5 %		
Reverse polarity protection	●		
Fuse for process voltage UP	10 A miniature fuse		
Connections for sensor voltage supply	●		
Terminal 24 V and 0 V			
Conversion error of analog values caused by non-linearity, calibration errors ex and the resolution in the nominal range	-	-	±1.5 %
Maximum cable length for connected process signals			
Shielded cable	1000 m	1000 m	-
Unshielded cable	600 m	600 m	-
Max. line length of the analog lines, conductor cross section > 0.14 mm ²	-	-	100 m
Potential isolation			
Per module	●		
Fieldbus connection	Via AC500 CPU or PROFINET® coupler		
Voltage supply for the module	Internally via extension bus interface (I/O bus)		
Approvals	CE, cUL, UL, C-Tick		

AC500-S

System data

Operating and ambient conditions

Voltages according to EN 61131-2

24 V DC	Process and supply voltage	24 V DC (-15 %, +20 % without ripple)
	Absolute limits	19.2...30 V inclusive ripple
	Ripple	< 5 %
	Protection against reverse polarity	Yes
Allowed interruptions of power supply acc. to EN 61131-2	DC supply	Interruption < 10 ms, time between 2 interruptions > 1 s

Important: Exceeding the maximum power supply voltage (> 30 V DC) for process or supply voltages could lead to unrecoverable damage of the system. The system could be destroyed.

Temperature	Operation	0...60 °C (horizontal mounting of modules)
		0...40 °C (vertical mounting of modules and output load reduced to 50 % per group)
	Storage	-40...+70 °C
	Transport	-40...+70 °C
Humidity		Max. 95 %, without condensation
Air pressure	Operation	> 800 hPa / < 2000 m
	Storage	> 660 hPa / < 3500 m

6

Creepage distances and clearances

Insulation Test Voltages, Routine Test, according to EN 61131-2	AC voltage during 2 seconds
24 V circuits (supply, 24 V inputs/outputs), if they are electrically isolated against other circuitry	350 V

The creepage distances and clearances meet the requirements of the overvoltage category II, pollution degree 2.

AC500-S

System data

Power supply units

For the supply of the modules, power supply units according to PELV specifications must be used.

Electromagnetic Compatibility

Immunity

Against electrostatic discharge (ESD)		According to EN 61000-4-2, zone B, criterion B
Electrostatic voltage in case of	air discharge	±8 kV
	contact discharge	±4 kV
ESD with communication connectors		In order to prevent operating malfunctions, it is recommended, that the operating personnel discharge themselves prior to touching communication connectors or perform other suitable measures to reduce effects of electrostatic discharges.
ESD with connectors of Terminal Bases		The connectors between the Terminal Bases and CPUs or Communication Modules must not be touched during operation. The same is valid for the I/O-Bus with all modules involved.
Against the influence of radiated (CW radiated)		According to EN 61000-4-3, zone B, criterion A
Test field strength		10 V/m
Against transient interference voltages (burst)		According to EN 61000-4-4, zone B, criterion B
Supply voltage units	DC	2 kV
Digital inputs/outputs	24 V DC	2 kV
Analog inputs		1 kV
Against the influence of line-conducted interferences (CW conducted)		According to EN 61000-4-6, zone B, criterion A
Test voltage		10 V zone B
High energy surges		According to EN 61000-4-5, zone B, criterion B
Power supply	DC	1 kV CM (1) / 0.5 kV DM (2)
DC I/O supply, add. DC-supply-out		0.5 kV CM (2) / 0.5 kV DM (2)
I/O analog, I/O DC unshielded		1 kV CM (2) / 0.5 kV DM (2)
Radiation (radio disturbance)		According to EN 55011, group 1, class A

(1) High requirement for shipping classes is achieved with additional specific measures (see specific documentation).

(2) CM = Common Mode; DM = Differential Mode.

Mechanical Data

Wiring method / terminals

Mounting	Horizontal (DIN rail mounting)
Degree of protection	IP20
Housing	According to UL 94
Vibration resistance acc. to EN 61131-2	all three axes (DIN rail mounting) 5...11.9 Hz, continuous 3.5 mm 11.9...150 Hz, continuous 1 g
Shock resistance	All three axes 15 g, 11 ms, half-sinusoidal

Mounting of the modules

DIN rail according to DIN EN 50022	35 mm, depth 7.5 mm or 15 mm
Mounting with screws	Screws with a diameter of 4 mm
Fastening torque	1.2 Nm

AC500-S-XC

System data

Operating and ambient conditions

Voltages according to EN 61131-2

24 V DC	Process and supply voltage	24 V DC (-25 %, +30 % without ripple)
	Absolute limits	18...31.2 V inclusive ripple
	Ripple	< 10 %
	Protection against reverse polarity	Yes
Allowed interruptions of power supply acc. to EN 61131-2	DC supply	Interruption < 10 ms, time between 2 interruptions > 1 s

Important: Exceeding the maximum power supply voltage (> 30 V DC) for process or supply voltages could lead to unrecoverable damage of the system. The system could be destroyed.

Temperature	Operation	-40...+70 °C (horizontal mounting of modules) -40...+40 °C (vertical mounting of modules and output load reduced to 50 % per group)
	Storage	-40...+85 °C
	Transport	-40...+85 °C
Humidity		Max. 100 %, with condensation
Air pressure	Operation	620...1080 hPa / (-1000...4000 m) > 2000 m (< 795 hPa): max. operating temperature must be reduced by 10 °C.
	Storage	> 620 hPa / < 4000 m

6

Creepage distances and clearances

Insulation Test Voltages, Routine Test, according to EN 61131-2	AC voltage during 2 seconds
24 V circuits (supply, 24 V inputs/outputs), if they are electrically isolated against other circuitry	350 V

The creepage distances and clearances meet the requirements of the overvoltage category II, pollution degree 2.

AC500-S-XC

System data

Power supply units

For the supply of the modules, power supply units according to PELV specifications must be used.

Electromagnetic Compatibility

Immunity

Against electrostatic discharge (ESD)		According to EN 61000-4-2, zone B, criterion B
Electrostatic voltage in case of	air discharge	±8 kV
	contact discharge	±4 kV
ESD with communication connectors		In order to prevent operating malfunctions, it is recommended, that the operating personnel discharge themselves prior to touching communication connectors or perform other suitable measures to reduce effects of electrostatic discharges.
ESD with connectors of Terminal Bases		The connectors between the Terminal Bases and CPUs or Communication Modules must not be touched during operation. The same is valid for the I/O-Bus with all modules involved.
Against the influence of radiated (CW radiated)		According to EN 61000-4-3, zone B, criterion A
Test field strength		10 V/m
Against transient interference voltages (burst)		According to EN 61000-4-4, zone B, criterion B
Supply voltage units	DC	2 kV
Digital inputs/outputs	24 V DC	2 kV
Analog inputs		1 kV
Against the influence of line-conducted interferences (CW conducted)		According to EN 61000-4-6, zone B, criterion A
Test voltage		10 V zone B
High energy surges		According to EN 61000-4-5, zone B, criterion B
Power supply	DC	1 kV CM (1) / 0.5 kV DM (2)
DC I/O supply, add. DC-supply-out		0.5 kV CM (2) / 0.5 kV DM (2)
I/O analog, I/O DC unshielded		1 kV CM (2) / 0.5 kV DM (2)
Radiation (radio disturbance)		According to EN 55011, group 1, class A

(1) High requirement for shipping classes is achieved with additional specific measures (see specific documentation).

(2) CM = Common Mode; DM = Differential Mode.

Mechanical Data

Wiring method / terminals

Mounting	Horizontal (DIN rail mounting)
Degree of protection	IP20
Housing	According to UL 94
Vibration resistance acc. to EN 61131-2	all three axes (DIN rail mounting) 5...11.9 Hz, continuous 3.5 mm 11.9...150 Hz, continuous 1 g
Shock resistance	All three axes 15 g, 11 ms, half-sinusoidal

Mounting of the modules

DIN rail according to DIN EN 50022	35 mm, depth 7.5 mm or 15 mm
Mounting with screws	Screws with a diameter of 4 mm
Fastening torque	1.2 Nm

CP635

7



Back



Forth



Alarms



CP600 and CP400 series HMI and control panels

[Key features](#) [7/132](#)

CP600 series and CP400 series

HMI panels	7/133
Control panels	7/133

Technical data

CP600	7/134
CP400	7/135

HMI and control panels

Key features CP600

- Aluminium housing
- Front protection IP66
- Engineering software Panel Builder 600 integrated in Automation Builder



- Improved flexibility and integration
- Two versions available:
 - CP600: Configuration with PB610 Panel Builder 600 for clear tailor made visualization.
 - CP600-WEB: visualization of AC500 web server with Automation Builder visualization. The Automation Builder debugging and diagnostics screens can be converted effortlessly for use with CP600-WEB control panels.

- Brilliant colored display
- Free reusable 3D graphic elements (Widgets)
- Import tags from PLC, drives, motion controller and robots configuration within Automation Builder

CP600 series and CP400 series HMI panels and control panels



CP651

HMI panels

Resolution	Display size	Type	Order code	Price	Weight (1 pce) kg
pixels					
480 x 272	4.3"	CP620	1SAP520100R0001		0.950
320 x 240	5.7"	CP630	1SAP530100R0001		1.150
800 x 480	7.0"	CP635	1SAP535100R0001		1.100
800 x 600	10.4"	CP651	1SAP551100R0001		2.100
800 x 600	12.1"	CP661	1SAP561100R0001		2.800
1280 x 800	13.3"	CP665	1SAP565100R0001		2.600
1024 x 768	15"	CP676	1SAP576100R0001		3.800
480 x 272	4.3"	CP620-WEB	1SAP520200R0001		0.950
320 x 240	5.7"	CP630-WEB	1SAP530200R0001		1.150
800 x 480	7.0"	CP635-WEB	1SAP535200R0001		1.100
800 x 600	10.4"	CP651-WEB	1SAP551200R0001		2.100
800 x 600	12.1"	CP661-WEB	1SAP561200R0001		2.800
1280 x 800	13.3"	CP665-WEB	1SAP565200R0001		2.600
1024 x 768	15"	CP676-WEB	1SAP576200R0001		3.800

Communication cables (connection control panel <-> PLC)

Description	Type	Order code	Price	Weight (1 pce) kg
Communication cable RS232: CP600-AC500	TK681	1SAP500981R0001		0.130
Communication cable RS485: CP600-AC500-eCo	TK682	1SAP500982R0001		0.130

Programming software

Description	Type	Order code	Price	Weight (1 pce) kg
Panel Builder 600 stand-alone engineering tool (1) (also available as part of the engineering suite Automation Builder)	PB610	1SAP500900R0001		0.150

(1) Delivery includes the programming software and corresponding documentation for software and control panels on USB-ROM.



CP415

Control panels

Resolution	Display	Type	Order code	Price	Weight (1 pce) kg
pixels					
240 x 240	3.5", 16 grey levels	CP415M	1SBP260191R1001		0.230
320 x 240	5.7", 16 blue levels	CP430B	1SBP260183R1001		0.810

Programming cables

Plug on CP400 side	Description	Type	Order code	Price	Weight (1 pce) kg
Sub-D 9	Connection to COM1. Length: 4 m	TK401	1SBN260216R1001		0.180
Sub-D 25	Connection to COM2. Length: 4 m	TK402	1SBN260217R1001		0.230

Communication cables (connection control panel <-> PLC)

Plug on PLC side	PLC	Type	Order code	Price	Weight (1 pce) kg
Sub-D 9	AC500	TK405	1SBN260221R1001		0.130
Sub-D 9	AC500-eCo	TK406	1SBN260224R1001		0.130

Programming software

Description	Type	Order code	Price	Weight (1 pce) kg
Programming software for CP400 (1)	CP400Soft	1SBS260284R1001		0.100

(1) Delivery includes the programming software and corresponding documentation on CD-ROM.

CP600 series

Technical data

Type	CP620	CP630	CP635	CP651	CP661	CP665	CP676
Application	control panels for PB610 Panel Builder 600 applications only Features, supported from V1.90.0.975						
Type	CP620-WEB	CP630-WEB	CP635-WEB	CP651-WEB	CP661-WEB	CP665-WEB	CP676-WEB
Application	control panels for visualization of AC500 web server applications, provided by AC500, AC500-eCo PLCs						
Display							
Exact display size diameter	4.3" widescreen	5.7"	7" widescreen	10.4"	12.1"	13.3" widescreen	15"
Resolution	480 x 272 pixels	320 x 240 pixels	800 x 480 pixels	800 x 600 pixels	800 x 600 pixels	1280 x 800 pixels	1024 x 768 pixels
Display type, colors	TFT color, 64 k						
Touch screen material	glass covered by plastic film						
Touch screen type	analog resistive, 4 wires						
Backlight type, life	LED, 40 000 h typ at 25 °C						
Brightness	150 CD/m ²	200 CD/m ²	300 CD/m ²				
Housing							
Protection class front, rear	IP66, IP20						
Front side material	Zamak			Aluminium			
Reverse side material	Zamak	Aluminium					
System resources							
Processor type	ARM Cortex A8: 600 MHz			ARM Cortex A8: 1 GHz			
Operating system, version	Microsoft Windows CE 6.0 Core						
User memory type, capacity	Flash disk, 128 MB			Flash disk, 256 MB			
RAM type, capacity	256 MB DDR						
Interfaces							
Ethernet ports, number, type	2 - 10/100 Mbit (with integrated Switch function)						
USB Host ports number, type	1 - ver. 2.0	2 - 1 ver. 2.0, 1 ver. 2.0 and ver. 1.1					
Serial ports number, type	1 - RS-232/-485/-422 software configurable						
Additional ports number, type	1 - Expansion slot	2 - Expansion slot for future modules for future modules					
Card slot number, type	1 - SD card slot						
Power supply voltage nominal, tolerance	24 V DC, 18...30 V DC						
Current consumption at nominal voltage	0.4 A	0.7 A	0.7 A	1.0 A	1.05 A	1.15 A	1.4 A
Battery type	Rechargeable Lithium battery, not user-replaceable						
Weight	0.95 kg	1.15 kg	1.1 kg	2.1 kg	2.8 kg	2.6 kg	3.8 kg
Faceplate dimensions (L x H)	149 mm x 109 mm	187 mm x 147 mm		287 mm x 232 mm	337 mm x 267 mm	392 mm x 307 mm	
Cutout dimensions (L x H)	136 mm x 96 mm	176 mm x 136 mm		276 mm x 221 mm	326 mm x 256 mm	381 mm x 296 mm	
Environmental conditions							
Operating temperature range	0...50 °C						
Operating humidity range	5...85 % relative humidity, non-condensing						
Storage temperature range	-20...+70 °C						
Storage humidity range	5...85 % relative humidity, non-condensing						
Approvals	See detailed page 168 or www.abb.com/plc						

CP400 series

Technical data

Type	CP415M	CP430B
Display size	3.5"	5.7"
Resolution	240 x 240 pixels	320 x 240 pixels
Display type	Touch Mono FSTN 16 grey	Touch 16 blue, STN
Brightness	90 cd/m ²	110 cd/m ²
Contrast adjustment	Via touch panel	Via touch panel
Back-light type	LED	CCFL
Back-light life	40 000 h	50 000 h
Touch screen (number of times)	> 1 million	> 1 million
Function keys / other keys	-	5 keys + 1 key menu
Application flash prom	4 MB	4 MB
RTC (rechargeable lithium battery)	●	●
Ethernet	-	-
Alarm management	●	●
Recipe management	-	-
Data/Recipe	-	-
Trends	●	●
Data storage (CF card)	-	-
Communication interface	1	2
USB 2.0	-	-
Printer port	-	-
Consumption	< 330 mA	< 840 mA
Dimensions L x H x W (external)	96 x 96 x 40.6 mm	195 x 145 x 60 mm
Weight	0.23 kg	0.81 kg
For the entire range		
RISC CPU	32 bit	
Graphics and text	●	
Macro and Ladder	●	
On-line and off-line simulation	●	
Real time clock	●	
Password protection	●	
Supply voltage	24 V DC ±15 %	
Class protection	IP65	
Approvals	RoHS, cUL	

ABB

System

Boiler DEMO

Operate

Message list

View

Display

Tools

Print

Help



Medium A

96.9 l/h

Medium B

17.7 l/h

132.3 °C

0.0 l/h

20.0 °C



Sound On

Man

Auto

DigiVis 500

Supervision software

[Key features](#) 8/138

Your supervision software from ABB

[Ordering details](#) 8/139

[Technical data](#) 8/140

DigiVis 500

Key features

Interacts easily with AC500 PLC via OPC and allows High Availability (HA) ABB PLC systems management

Dual-display enhanced mode and "DigiBrowse" options offer availability and easy access to data outside the software



- Adaptable from 50 to an unlimited number of variables
- Flexible license scheme so customers can easily extend based on demand

DigiVis 500

Your supervision software from ABB



DigiVis 500 USB, software and documentation

Ordering details

Description	Type	Order code	Price	Weight (1 pce) kg
Operations licenses				
OPC signals	50	DV500-OP50	1SAP501800R0021	0.050
	100	DV500-OP100	1SAP501800R0031	0.050
	250	DV500-OP250	1SAP501800R0041	0.050
	500	DV500-OP500	1SAP501800R0051	0.050
	1000	DV500-OP1000	1SAP501800R0061	0.050
	2000	DV500-OP2000	1SAP501800R0071	0.050
	unlimited	DV500-OPUNL	1SAP501800R0081	0.050
Operation expansion licenses				
OPC signals	50...100	DV500-EXP100	1SAP501800R0091	0.050
	100...250	DV500-EXP250	1SAP501800R0101	0.050
	250...500	DV500-EXP500	1SAP501800R0111	0.050
	500...1000	DV500-EXP1000	1SAP501800R0121	0.050
	1000...2000	DV500-EXP2000	1SAP501800R0131	0.050
	unlimited	DV500-EXPUNL	1SAP501800R0141	0.050
Software				
USB dongle		DV500-USB	1SBN260318R1001	0.100
Software and Documentation CD		DV500-CD	1SAP501900R0001	0.150
Software options				
Graphics Builder		DV500-GBUILDER	1SAP501800R0011	0.050
USB dongle replacement license		DV500-USB-R	1SAP501800R0151	0.050
WEB Display runtime		DV500-WEBDIS	1SAP501800R0161	0.050
Dual monitor Support		DV500-DUALMON	1SAP501800R0171	0.050
DigiBrowse		DV500-DIGIB	1SAP501800R0181	0.050
Security Lock		DV500-SLOCK	1SAP501800R0191	0.050

DigiVis 500

Your supervision software from ABB

Technical data

Type	DigiVis 500
Description	Creation and operation of windows-based supervision of AC500 based automation systems via OPC
Features	<ul style="list-style-type: none"> - User interface/system supervision design for PC without need for scripting - Clear information hierarchy - Optional user authorization control and security lock, up to 16 user profiles with up to 1 000 users - Multi-monitor screens - Rich choice of displays, images and log functions - Graphics editor and macros - Trending and archiving - Acoustic alarms - OPC configuration - Commissioning & debugging - Automatic code documentation - DigiBrowse – standalone archive viewer - Operation mode - Report generation - Audit trails/user action logging - On-the-fly software updating without restarting the application - Languages: English.
Minimum engineering PC requirements	Windows XP Professional SP3 or Windows 7 Professional SP1, 32 or 64-bit, 2 GHz, 1 GB RAM, 10 GB free disk space.
Target Systems	PC with Windows XP Professional SP3 or Windows 7 Professional SP1, 32-bit, 2 GHz, 3 GB RAM, 2 GB free disk space (≥80 GB for archiving).
Components and options	<ul style="list-style-type: none"> - DigiVis 500 Graphics Builder - DigiVis 500 operations - ABB OPC tunnel - AC500 standard tag type library - Web display runtime - Dual monitor support - DigiBrowse - Security lock.

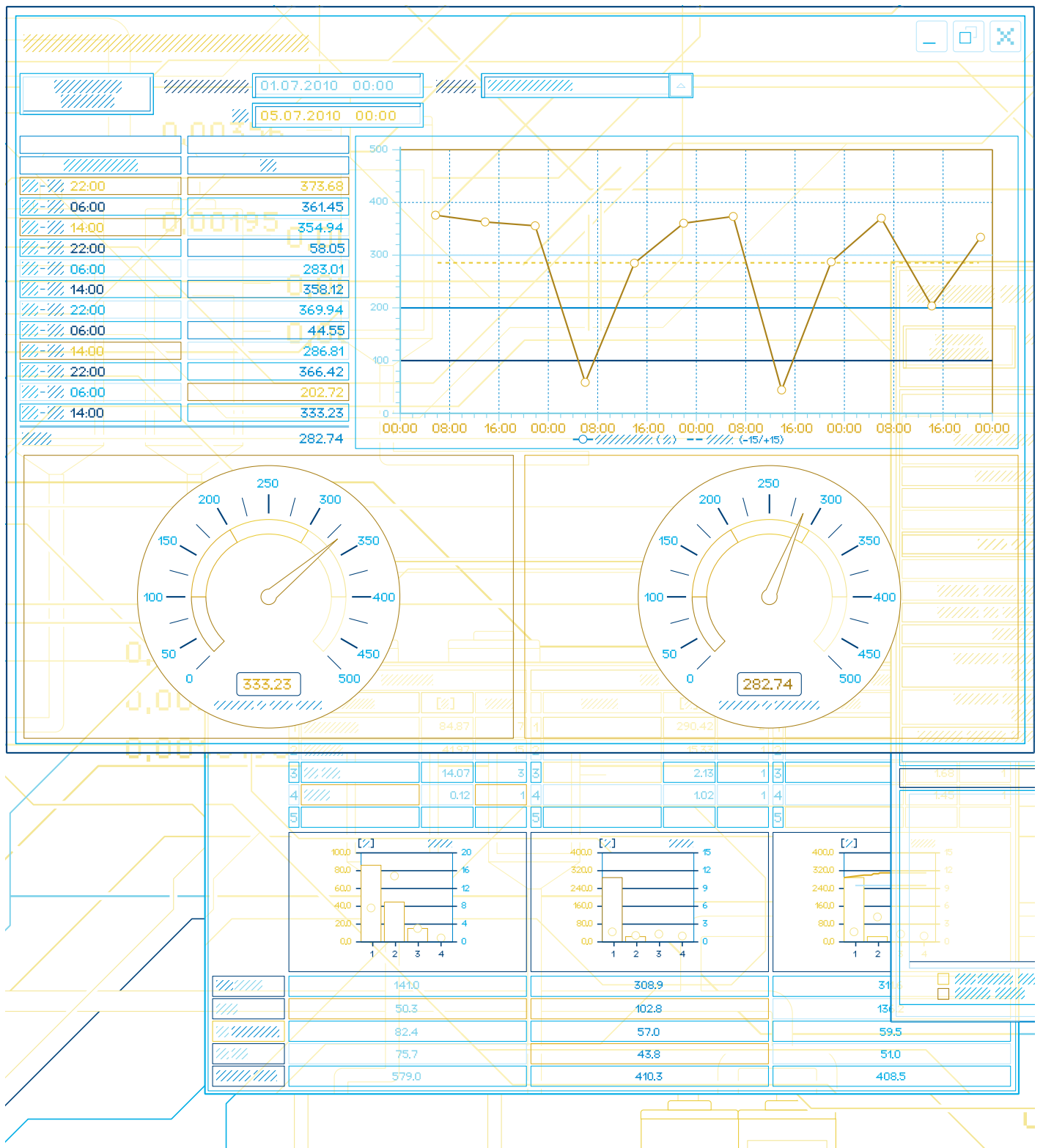



Low voltage drives

[ACS880 series, all compatible ABB industrial drives](#) 9/144

[ABB general purpose drives offer ease-of-use](#) 9/145

[ABB machinery drives for flexible needs](#) 9/146

[ABB machinery drives ACSM1](#) 9/147

ACS880 series

all-compatible ABB industrial drives

The ACS880 series drives introduce a new generation of industrial drives. These drives are easily adaptable to suit different customer needs and integrate into various industry solutions. The drives are part of ABB's new all-compatible drives portfolio that is designed to provide customers across industries and applications with unprecedented levels of compatibility, flexibility and ease of use. The new ACS880 industrial drives are compatible

with virtually all types of processes, automation systems, user groups and business requirements. Yet, despite the drives' wide-ranging capabilities, they are remarkably easy to use and integrate.

The ACS880 drives offering will grow alongside with the ACS800 drives. They are available as single drives, multidrives and drive modules.

ACS880-01, wall-mounted drives highlights

- Compact wall-mounted drives with all important features built-in the drive, saving installation space and time
- Premium motor control with direct torque control (DTC) for virtually any type of AC motor, including permanent magnet motors
- A broad range of options offer flexibility and universal connectivity
- Built on ABB's all-compatible drives architecture providing unprecedented levels of compatibility, flexibility and ease-of-use.

All-compatible
wall-mounted drive
with everything
built-in



9

Features

- Power range 0.55...250 kW (208...690 V)
 - IP21 as standard (UL type 1), IP55 as option (UL type 12)
 - Integrated safety including safe torque-off (STO) as standard with several safety functions as options
 - Intuitive control panel with USB connection and support up to 20 languages
 - Common PC tool, Drive composer, for commissioning and configuration
 - Drive-to-drive link for fast communication between drives including master-follower configurations without any additional software
 - Removable memory unit for easy setup and maintenance
 - Drive's energy efficiency information and the energy optimizer feature help to improve process efficiency
- Options include:
 - I/O extension modules
 - Fieldbus adapter modules
 - Safety functions module
 - Speed feedback interfaces
 - EMC filter, braking chopper.

ABB general purpose drives offer ease-of-use

ABB general purpose drives are designed to control a wide range of applications such as pumps, fans, conveyors and mixers, as well as process control in industries including material handling, food and beverage, chemical, rubber and plastics, textile and printing. The drives are easy to select, install, configure and use, saving considerable time as most features are built-in as standard.

Built-in features for pump and fan applications



ACS310 highlights

- Designed for pump and fan applications, such as booster pumps and process ventilation
- Compact dimensions with unified height and depth save space and facilitate cabinet installations
- Equipped with pump and fan control (PFC), PID control with booster functionality and pump protection function to optimize pump or fan flow, to cut maintenance costs and to save energy.

Features

- Power range 0.37...2.2 kW (1-phase 200...240 V), 0.37...11 kW (3-phase 200...240 V)
- Power range 0.37...22 kW (3-phase 380...480 V)
- IP20 enclosure, optional NEMA 1 kit
- Built-in pump and fan features such as multi-pump control, pipe clean and fill functions
- Built-in C3 EMC filter and Modbus EIA-485 fieldbus interface
- Options
 - Basic and assistant control panels
 - Input and output chokes
 - Relay output extension module
 - External EMC filter for 1st environment
 - FlashDrop tool for unpowered drive configuration in 2 seconds.

A wide power range for a broad range of industries



ACS580 Highlights

- Wide power range and vector control (SVC) for variable and constant torque applications such as pumps and fans, conveyors and mixers
- Many built-in features including an EMC filter for the 1st environment, a Modbus® RTU interface and a swinging choke to enhance harmonics reduction and reduce the space needed for installation
- Intuitive control panel and assistants for fast setup and commissioning, STO input for safe torque off (SIL3)
- Built on ABB's all-compatible drives architecture providing compatibility, flexibility and ease-of-use.

Features

- Power range 0.75...250 kW (3-phase 380...415 V, 440...480 V)
- Wall-mounted drives, IP21 as standard (UL type 1), IP55 optional (UL type 12 in frame sizes R0-R9)
- Options
 - Basic and assistant control panel
 - Built-in C3 EMC filter and Modbus EIA-485 fieldbus interface
 - Plug-in fieldbus adapters, panel mounting kits, remote monitoring
 - Output chokes
 - Brake units and brake chopper
 - Expansion module for
 - relay outputs
 - digital outputs
 - +24 V DC/AC supply
 - electrically isolated PTC input
 - PC tool: DriveComposer entry/pro (compatible with ACS880)

ABB machinery drives for flexible needs

ABB machinery drives are designed to meet the production and performance needs of machine builders, system integrators, panel builders and end users in a broad range of applications. The drives can be flexibly programmed to meet the demands of different machine solutions. A wide range of features and options provide optimal solutions.

Compact and easy drives to install, set and commission



Flexibility and scalability for machinery applications



ACS355 highlights

- A compact drive with a wide range of built-in features including safety functionality
- Sequence programming provides an easy way to implement drive's control logic
- A wide range of options for enhanced performance and flexible connectivity to different processes
- Compact dimensions with unified height and depth save space and facilitate cabinet installations.

Features

- Power range 0.37...2.2 kW (1-phase 200...240 V), 0.37...11 kW (3-phase 200...240 V)
- Power range 0.37...22 kW (3-phase 380...480 V)
- IP20 enclosure, optional NEMA 1 kit
- IP66, IP67 or IP69K as optional variant up to 7.5 kW
- Scalar control, open and closed loop vector control
- Advanced functionality with sequence programming
- Induction and permanent magnet motor control
- Built-in brake chopper and EMC filter for 2nd environment
- Integrated safe torque-off (STO) as standard
- Options
 - Basic and assistant control panels
 - Potentiometer, plug-in fieldbus adapters, encoder interface, relay output extension module, input and output chokes
 - External EMC filter for 1st environment
 - FlashDrop tool for unpowered drive configuration in 2 seconds.

ACS850 highlights

- Covers a wide power and voltage range, and provides a variety of standard and optional features making adaptation to different applications easy
- The standard control program can be easily modified to meet specific application needs and function block programming provides additional flexibility
- Equipped with direct torque control (DTC) providing highly accurate open and closed loop control for different types of motors.

Features

- Power range 0.37...560 kW (380...500 V)
- IP20 enclosure (UL open type) as standard
- Compact size and side-by-side mounting save space in cabinets
- Built-in input chokes for harmonic filtering
- Built-in braking chopper up to 45 kW as standard
- Induction, permanent magnet and synchronous reluctance motor control
- Extensive input and output connectivity as standard
- Integrated safe torque-off (STO) as standard
- Removable memory unit for easy drive management
- Options
 - Plug-in fieldbus adapters, I/O extensions and feedback interface modules
 - PC tools: DriveStudio for startup, tuning and programming, DriveSPC for modifying and extending functionality
 - Synchronous reluctance motor and drive packages
 - Crane control program for stand-alone cranes
 - EMC filters, braking options, du/dt filters.

ABB machinery drives ACSM1

ABB machinery drives offer flexible technologies and high performance motor control to solve a wide variety of applications. The range includes powers from less than 1 kW to more than 100 kW. The drives enable operation with single and three-phase supplies for global markets, and have open communication options as well as real-time Ethernet technologies such as EtherCAT® and PowerLink.

ACSM1 highlights

- Wide power range, different product variants and programming flexibility ensure an optimum solution for both single and multi-axis systems.
- Control of synchronous and asynchronous motors with direct torque control (DTC) in open or closed loop
- Regenerative supply for applications with high braking power duty cycles.

Features

- Three-phase operation 230...500 V AC
- 3...635 A rms, power range 0.75...355 kW
- IP20 enclosure for cabinet installation (UL open)
- Suitable for single drive and multidrive configurations
- Speed, torque and motion control
- Controls synchronous and induction motors
- Integrated safe torque-off (STO) as standard
- Innovative memory unit for easy drive management.

Our intelligent machinery drives include programming options for single and multi-axis control applications or can be combined with our multi-axis motion controllers and PLC products for system solutions.

The flexible workhorse for many high performance applications



- Options:
 - Various control options for encoder feedback and communication with master and I/O extension
 - Cooling variants: air, cold-plate, push-through
 - Winder control program
 - Regenerative supply
 - Drive variant for lift application.



Motion control

Servo drives	10/150
AC motion control drives	10/152
Motion controllers	10/154

Servo drives

Analog, PTO, POWERLINK and EtherCAT® options

MicroFlex Analog

- Compact motion control drive for single and three-phase operation
- ± 10 V analog speed / torque demand or Pulse + Direction inputs
- Choice of resolver feedback or incremental encoder / SSI
- Pulse Train control inputs compatible to Pulse Train Output (PTO) module FM562 for AC500 and AC500-eCo.



Compact motion control drive for simple analog or PTO control

MicroFlex e100

- Compact motion control drive for single and three-phase operation
- Ethernet PowerLink technology for real-time motion control
- MINT programming for multitasking control of communications, logic, motion and HMI interaction in simple motion applications.



Compact motion control drive with real time Ethernet POWERLINK technology

10

Series MicroFlex Analog

- 1 or 3-phase operation 105...250 V AC
- 3, 6 and 9 Arms
- IP20 enclosure for cabinet installation (UL open)
- Auto-tuning and anti-resonance digital filters
- Suitable for single drive and multi-axis systems
- Controls rotary and linear AC servo motors
- Options
 - Space saving footprint EMC filter
 - Brake units.

For further information, see flyer "ABB motion control drives, MicroFlex brushless AC servo drives", code: 3AUA0000123110 EN.

Series MicroFlex e100

- 1 or 3-phase operation 105...250 V AC
- 3, 6 and 9 Arms
- IP20 enclosure for cabinet installation (UL open)
- Real-time Ethernet operation with PowerLink
- Suitable for single drive and multi-axis systems
- Controls rotary and linear AC servo motors
- Options
 - Space saving footprint EMC filter
 - Brake units.

For further information, see flyer "ABB motion control products, MicroFlex e100 servo drives", code: 3AUA0000116018 EN.

MicroFlex e150

- Compact motion control drive with embedded safety for single and three-phase operation
- Ethernet technology including EtherCAT® for real-time motion control
- Advanced MINT programming for multitasking control of communications, logic, motion and HMI interaction in high performance motion applications.



Intelligent motion control drive with embedded safety and EtherCAT® technology

Series MicroFlex e150

- 1 or 3-phase operation 105...250 V AC
- 3, 6 and 9 Arms
- IP20 enclosure for cabinet installation (UL open)
- Embedded real-time Ethernet including EtherCAT®, Modbus® TCP and Ethernet/IP™
- Suitable for single drive and multi-axis systems
- Controls rotary and linear AC servo motors
- Safe torque-off feature as standard
- Options
 - MINT Motion programming
 - Space-saving footprint EMC filter
 - Resolver adapter
 - Dual encoder splitter
 - Brake units.

For further information, see flyer "ABB motion control products, MicroFlex e150 servo drives", code: 3AUA0000097609 EN.

MotiFlex e180

- EtherCAT®, Modbus/TCP, EtherNet/IP and POWERLINK
- DSL combined power and feedback option
- Advanced MINT programming for multitasking control of communications, logic, motion and HMI interaction in high performance motion applications.
- Safety as standard



Versatile motion control drive with integrated real-time Ethernet technology

Series MotiFlex e180

- Three-phase operation 200...480 V AC
- 2.3 to 40 A with 200% servo duty, Arms in four frame sizes
- IP20 enclosure for cabinet installation (UL open)
- Real time Ethernet with EtherCAT and PowerLink and Modbus TCP and EtherNet/IP
- Suitable for single drive and multi-axis systems
- Controls rotary and linear AC servo motors
- Safe torque off as standard
- Memory unit for firmware, settings and functionality level
- Options
 - Drive functionality levels (Single axis Mint motion)
 - Feedback options, resolver, encoder, serial encoders or DSL.
 - Filters, brake resistors, and chokes

For further information, see flyer "ABB motion control products, MotiFlex e180 servo drives", code: 3AUA0000168682.

AC motion control drives

MicroFlex series



MicroFlex e150

MicroFlex e150 (EtherCAT®, Ethernet/IP, Modbus® TCP/IP, MINT programming)

- Compact EtherCAT® motion control drive
- Simple to advanced motion technology fully integrated
- Powerful PC tool for commissioning and auto-tuning
- Precise control of rotary and linear motors
- Embedded EtherCAT®, Ethernet/IPTM, Modbus® TCP/IP
- Standard I/O: (10) inputs + (7) outputs
- Universal and Dual Encoder function
- Safe Torque Off (STO) SIL3 PLe
- USB, RS485 serial and 7-segment display communications.

Input voltage	Bus voltage	Output current		Order code	Price
	V DC	Continuous Arms	Peak (3 s) Arms		
1/3 phase 105-250 V AC	160-320	3	6	E152A03EIOA	
1/3 phase 105-250 V AC	160-320	6	12	E152A06EIOA	
1/3 phase 105-250 V AC	160-320	9	18	E152A09EIOA	

EtherCAT® slave device drive (non-programmable)

1/3 phase 105-250 V AC	160-320	3	6	E152A03EINA	
1/3 phase 105-250 V AC	160-320	6	12	E152A06EINA	
1/3 phase 105-250 V AC	160-320	9	18	E152A09EINA	

Note: Will accept either incremental or absolute encoder feedback (BiSS, EnDat, SSI, SmartAbs®). Dual encoder mode and resolver supported via option.

MicroFlex e100 (Ethernet POWERLINK)

- Compact Ethernet Powerlink motion control drive
- Simple motion programming with MINT Lite software and auto-tuning
- Ethernet - Powerlink, Modbus® TCP and TCP/IP
- Universal encoder
- CANopen® port for simple expansion
- USB and RS485 serial communications
- LEDs: Drive status, CANopen®, Ethernet Powerlink.

1/3 phase 105-250 V AC	160-320	3	6	MFE230A003BW	
1/3 phase 105-250 V AC	160-320	6	12	MFE230A006BW	
1/3 phase 105-250 V AC	160-320	9	18	MFE230A009BW	

Note: Will accept either incremental or absolute encoder feedback (BiSS, EnDat, SSI, SmartAbs®).

MicroFlex analog

- Compact analog motion control drive
- Encoder/resolver feedback and simulated encoder output
- RS232/422 serial communications for PC tools
- Analog or pulse and direction control e.g. for motion control applications using AC500 or AC500-eCo CPUs with the Pulse Train Output module FM562.

Input voltage	Bus voltage	Output current		Order code		Price
	V DC	Continuous Arms	Peak (3 s) Arms	RS232 version	RS485 version	
Encoder/SSi feedback						
1/3 phase 105-250 V AC	160-320	3	6	FMH2A03TR-EN23W	FMH2A03TR-EN43W	
1/3 phase 105-250 V AC	160-320	6	12	FMH2A06TR-EN23W	FMH2A06TR-EN43W	
1/3 phase 105-250 V AC	160-320	9	18	FMH2A09TR-EN23W	FMH2A09TR-EN43W	
Resolver feedback						
1/3 phase 105-250 V AC	160-320	3	6	FMH2A03TR-RN23W	FMH2A03TR-RN43W	
1/3 phase 105-250 V AC	160-320	6	12	FMH2A06TR-RN23W	FMH2A06TR-RN43W	
1/3 phase 105-250 V AC	160-320	9	18	FMH2A09TR-RN23W	FMH2A09TR-RN43W	



MicroFlex analog

AC motion control drives

MotiFlex e180



MotiFlex e180 Size A/B
(1.5 A - 16 A)



MotiFlex e180 Size C
(21 A - 33.5 A)



MotiFlex e180 Size D
(48 A - 65 A)

MotiFlex e180

- Three-phase operation 200...480 V AC
- 2.3 to 40 A with 200% servo duty Arms in four frame sizes
- IP20 enclosure for cabinet installation (UL open)
- Real time Ethernet with EtherCAT and PowerLink and Modbus TCP and EtherNet/IP
- Suitable for single drive and multi-axis systems
- Controls rotary and linear AC servo motors
- Safe torque off as standard
- Memory unit for firmware, settings and functionality level

Size	Input voltage	Bus voltage V DC	Output current (8kHz)		Order code	Price
			Continuous Arms	Peak (3s) Arms		
A	3 phases 200-480 V AC	270-650	2.3	4.6	MFE180-04AN-03A0-4	
			3	6	MFE180-04AN-05A0-4	
			4	8	MFE180-04AN-07A0-4	
B	3 phases 200-480 V AC	270-650	7	14	MFE180-04AN-016A-4	
C	3 phases 200-480 V AC	270-650	12	24	MFE180-04AN-024A-4	
			18	36	MFE180-04AN-031A-4	
			25	50	MFE180-04AN-046A-4	
			28	56	MFE180-04AN-060A-4	
			40	80	MFE180-04AN-090A-4	

Accessories for MotiFlex e180

Description	Drive type	Order code	Price
Braking resistors			
JBR-01, IP20	03A0, 05A0, 07A0	68711401	
JBR-04, IP20	016A0	68711428	
JBR-05, IP20	024A0, 031A0	68711436	
JBR-06, IP20	046A0, 060A0, 090A0	68711444	
Mains choke			
CHK-01 - 0,75-1,5 kW	03A0	68711185	
CHK-02, 2,2-3,0 kW	05A0, 07A0	68711193	
CHK-04, 7,5 kW	016A0	68711231	
CHK-05, 11-15 kW	024A0, 031A0	68711240	
CHK-06, 18,5-22 kW	046A0	68711266	
CHK-07, 30 kW	060A0	68816238	
CHK-08, 37-45 kW	090A0	68816246	
DC choke			
DCL-01, 11-15 kW	024A0, 031A0	3AU0000035503	
DCL-02, 18,5-15 kW	046A0	3AU0000035504	
DCL-03, 30 kW	060A0	3AU0000036067	
DCL-04, 37-45 kW	090A0	3AU0000036068	
Mains filter EMC category C2			
JFI-02	03A0, 05A0, 07A0	68711321	
JFI-03	016A0	68711339	
JFI-05	024A0, 031A0, 031A0	68711355	
JFI-07	060A0, 090A0	68711371	

Feedback interface

Description	Order code	Price
FB-01: Incremental encoder + Halls	L517	
FB-02: Serial Encoder + SinCos (1v pk-pk)	L518	
FB-03: Resolver	L516	
FB-04: DSL (Stegman 2 wire solution)	L530	

Programming option

Description	Order code	Price
Single axis MINT programming	N8020	

Motion controllers

MINT programmable, analog, PTO, CANopen and POWERLINK

NextMove ESB-2

- Compact panel mount motion controller
- Up to 8 axes of coordinated motion
- Stepper and analog axis control
- CANopen manager for system expansion
- MINT programming for multitasking control of communications, logic, motion and HMI interaction in simple motion applications.

NextMove e100

- Compact panel mount motion controller
- Ethernet PowerLink technology for real-time motion control
- Stepper and analog axis control
- CANopen manager for system expansion
- MINT programming for multitasking control of communications, logic, motion and HMI interaction in simple motion applications.



Compact motion controller for analog and stepper control



Compact motion controller with real-time Ethernet POWERLINK technology

Series NextMove ESB-2

- Up to 8 axes of coordinated motion
- 4 x PTO (Stepper) axes
- 3 or 4 x analog controlled axes with encoder feedback
- Maximum of 8 axes of control
- Digital and analog I/O including 4 x high speed registration latches
- Options
 - RS232 or RS485 serial option
 - Differential / single-ended stepper interfaces
 - 7 axis or 8 axis variants.

Series NextMove e100

- 1 to 16 axes interpolated axes via POWERLINK
- Additional CN profiled POWERLINK axes
- 4 x PTO (stepper) axes
- 3 x analog controlled axes with encoder feedback
- Maximum of 30 axes of control
- Digital and analog I/O including 4 x high speed registration latches
- Options
 - Differential / single-ended stepper interfaces
 - 8, 12 or 16 axes of interpolated motion.

Motion controllers

NextMove



NextMove e100

NextMove e100 (Ethernet Powerlink, Modbus® TCP and Modbus RTU)

- Compact, high performance motion controller
- Real-time Ethernet Powerlink and Modbus® TCP/IP
- 8, 12 or 16 axes of interpolated motion
- (16 MN + 14 CN) profiled axes = max. 30 Powerlink axes
- 4 stepper axes / 3 analog axes
- CANopen® network manager
- RS232/422 and USB communications
- Advanced multitasking MINT programming
- ActiveX® controls
- Integrated digital/analog I/O including high speed registration inputs.

Number of axes	Order code		Price
	Differential stepper	Single ended stepper	
8	NXE100-1608DBW	NXE100-1608SBW (1)	
12	NXE100-1612DBW	NXE100-1612SBW (1)	
16	NXE100-1616DBW	NXE100-1616SBW (1)	

(1) For use with DSMS stepper/driver.



NextMove ESB-2

NextMove ESB-2

- Compact, panel mount motion controller
- Economical and simple to install
- Powerful multitasking MINT programming
- 4 axes of closed loop control
- 4 axes of open loop control (step/direction outputs)
- Max. 8 axes
- USB, serial and CANopen® provide flexible communications to PLC, distributed I/O and other devices
- Integrated digital/analog I/O including high speed registration inputs
- Firmware variant allows the controller to operate as a CANopen® DS402 master and control up to 64 axes.

Number of axes	Serial port	Order code		Price
		Differential stepper	Single ended stepper	
7	RS232 / USB	NSB202-501W	NSB203-501W	
7	RS485 / USB	NSB202-502W	NSB203-502W	
8	RS232 / USB	NSB204-501W	NSB205-501W	
8	RS485 / USB	NSB204-502W	NSB205-502W	



NextMove PCI-2

NextMove PCI-2

- Compact, high performance PCI-bus motion controller
- 4 stepper axes + 4 analog axes = max. 8 axes
- Onboard digital and analog I/O
- CANopen® for distributed control
- High speed PCI bus interface
- Advanced multitasking MINT or ActiveX® programming
- Firmware variant allows the controller to operate as a CANopen® DS402 master and control up to 64 axes.

Number of axes	Order code		Price
	PNP outputs	NPN outputs	
1 (2)	PCI201-501	PCI201-511	
2 (2)	PCI201-502	PCI201-512	
3 (2)	PCI201-503	PCI201-513	
4 (2)	PCI201-504	PCI201-514	
8 (3)	PCI201-508	PCI201-518	

(2) User configurable for servo or stepper. (3) 4-axis servo control and 4-axis stepper.

Plug in option cards for use with MotiFlex e100

- Plug-in motion controller
- 4 POWERLINK axes + 1 analog axes = max. 5 axes
- Onboard digital and analog I/O
- Encoder input for electronic gearing functions
- CANopen® manager for I/O expansion (via host drive)
- Add CP600 HMI via RS485 Modbus® RTU
- Fully utilize drive I/O and interfaces including additional option cards.



MotiFlex e100 connection panel

Description	Order code	Price
Single axis MINT motion option (plug-in)	OPT-MF-100	
Multi-axis MINT motion option (plug-in)	OPT-MF-101	

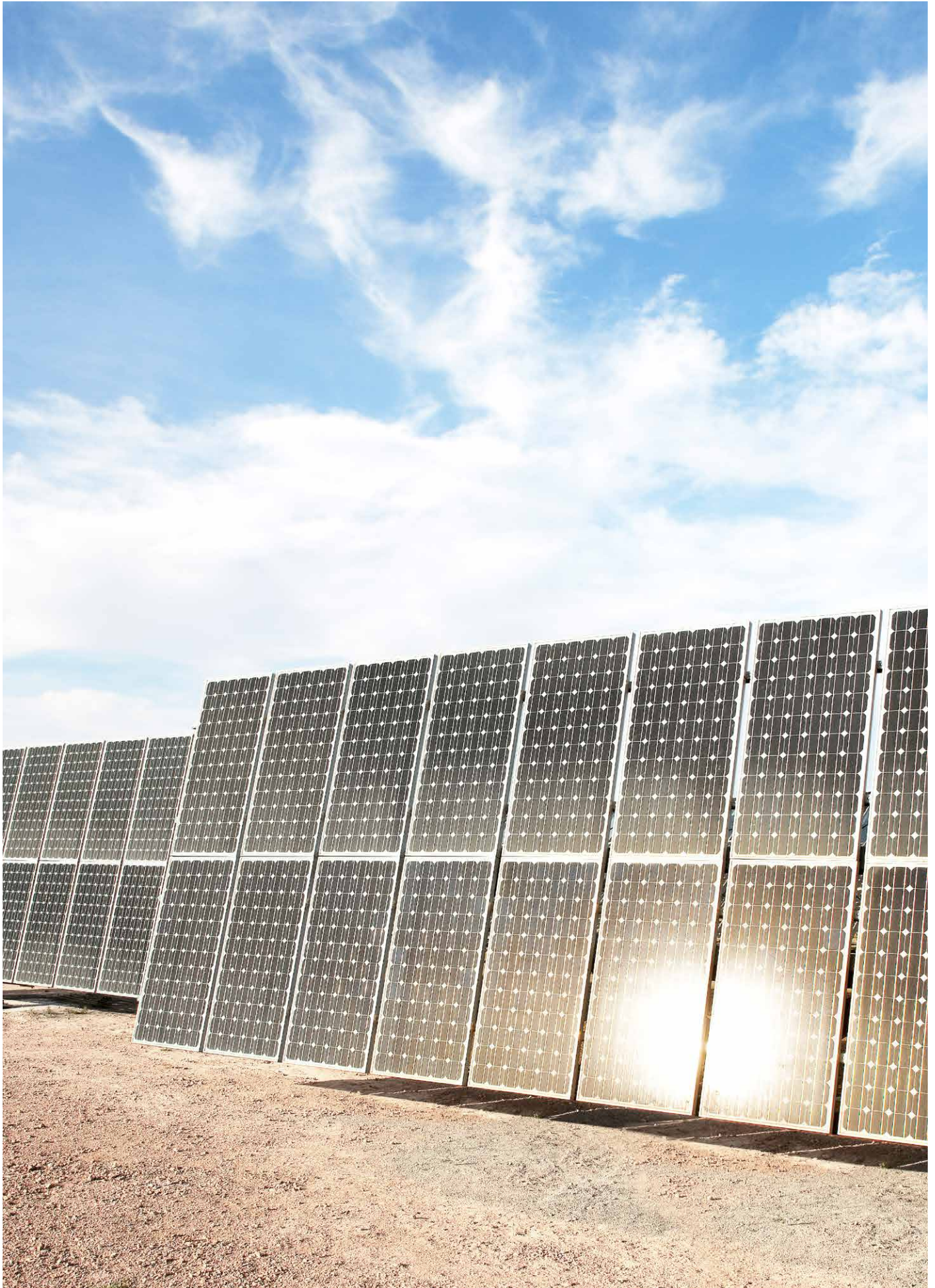

Application descriptions and additional information

Application descriptions

Network architecture	11/158
AC500 High Availability	11/160
Real-time Ethernet products	11/161
MINT motion solution - Real-time Ethernet systems	11/162

PLC Trainer AC500

11/164

AC500-eCo Starter kits

11/165

Additional information

Life cycle management for maximum return on investment	11/166
Approvals and certifications	11/168
AC500 website - Online tools	11/172
Order and delivery	11/173

Application descriptions

Network architecture

Communication with AC500 – always the right solution

Flexibility, real-time capability and the highest possible data transmission speed are just some of the communication demands made on automation systems. With its AC500 control system, ABB developed a communication platform offering customer oriented solutions for the most varied communication tasks. Simple network configuration and diagnostic options using the Automation Builder enables fast planning, implementation and commissioning, thus helping save engineering time and project costs. Among others, ABB's AC500 supports the following communication protocols:

PROFINET®

PROFINET® I/O meets the sophisticated demands placed on real time Ethernet protocols in the world of automation. Very fast data transmission, integrated and standardized network structures from the control to the field level as well as flexible network management support users in the implementation of their automation solutions.

PROFIBUS DP®

PROFIBUS DP® enables flexible configuration by means of a mono and multi-master systems structure. Data rates of up to 12 Mbit/s on twisted pair cables and/or optical fiber, as well as the option to connect up to 126 devices (master/slave) to one bus segment enable simple and robust communication solutions.

CANopen®

CANopen® offers fast data transmission and high immunity in Master/Slave network topologies, with up to 127 participants and transmission speeds of 10 kbit/s up to 1 Mbit/s depending on bus length.

CS31-Bus

CS31-Bus is a high-performance, proprietary ABB communication standard enabling transmission speeds of up to 187.5 kbit/s. Up to 31 bus participants can communicate via RS485, simple telephone cable or optical fiber lines.

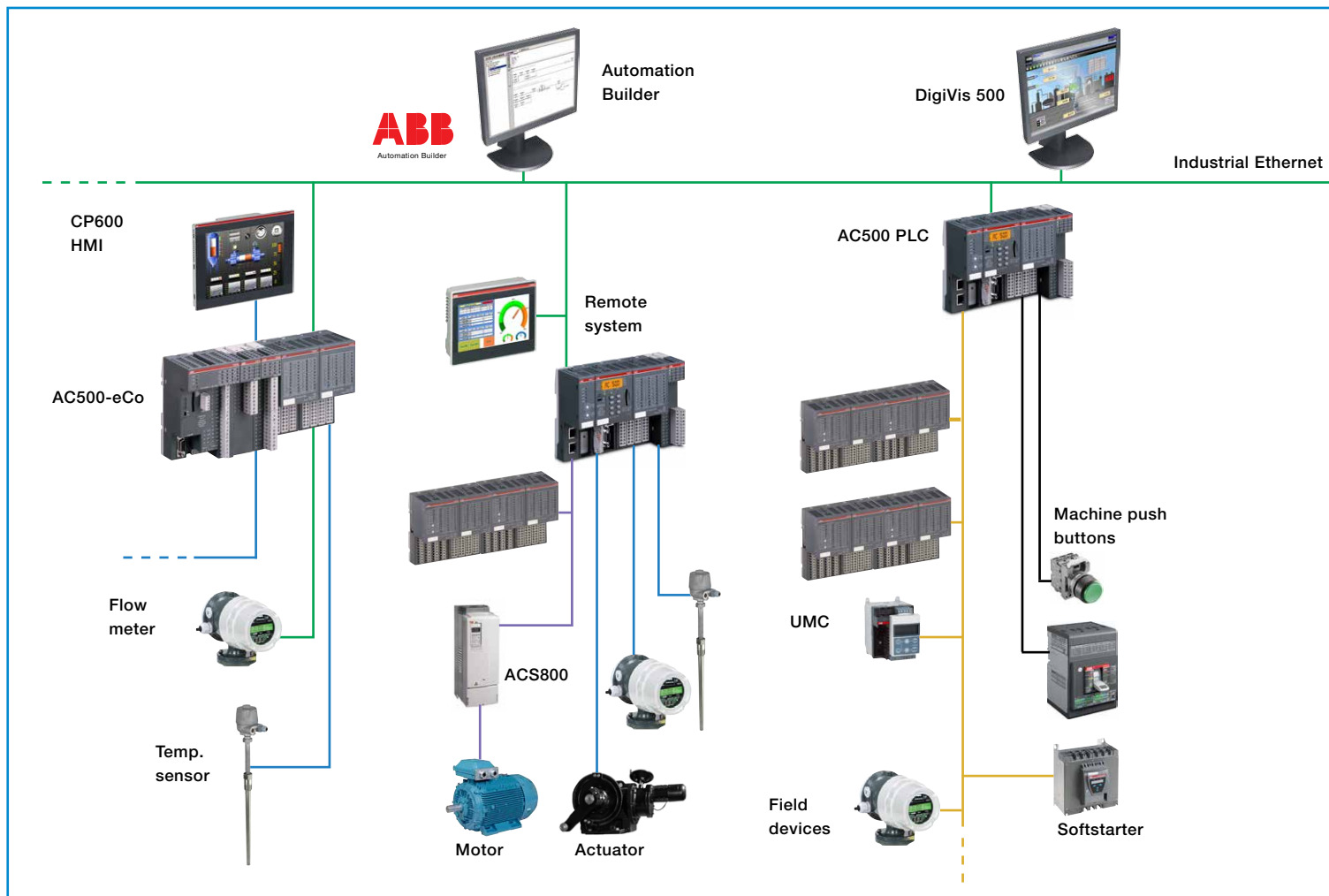

Modbus® TCP & RTU

Modbus® RTU is an open serial data protocol for the implementation of master/slave network configurations with up to 31 network partners. Different bus lengths depending on the serial communication interface enable data transmission speeds of up to 115.2 Kbit/s. Modbus® TCP is a common Ethernet based networking protocol.

RCOM

RCOM is a proprietary ABB bus protocol for master/slave communication via RS232/485. Based on expandability up to 254 RCOM Slaves and the most varied diagnostic options, this protocol is ideal for applications in the water and waste water industry.

Ethernet and Internet

Integrated communications, high data transmission rates and the use of existing data networks enable simple, customer specific solutions. Supported protocols are:

- HTTP for web server. Visualization for remote operations and maintenance

- FTP for file data-transfer
- SNTP, simple network time protocol. The PLC time can be synchronized using internet-hosted time services
- SMTP, to send e-mails with attachments
- TCP and UDP sockets can be programmed for project specific protocols. Library functions are available
- IEC60870-5-104 Telecontrol, mainly used for long distances as like pipe-lines, water and waste-water. The configuration of protocols is done with the Automation Builder software suite.
- DHCP for automatic assignment of IP addresses
- PING to check connection with other automation devices

EtherCAT®

EtherCAT® is an open Industrial Ethernet standard regulated in the international standards IEC 61158 and IEC 61784 as well as in ISO 15745-4. Because of its extremely high data transmission speeds, EtherCAT® is suitable as a real time Ethernet protocol for time critical applications within the area of motion control technology. Whether in "cam switch" functionalities or the most varied master/slave network configurations, AC500 delivers the right solution for your application.

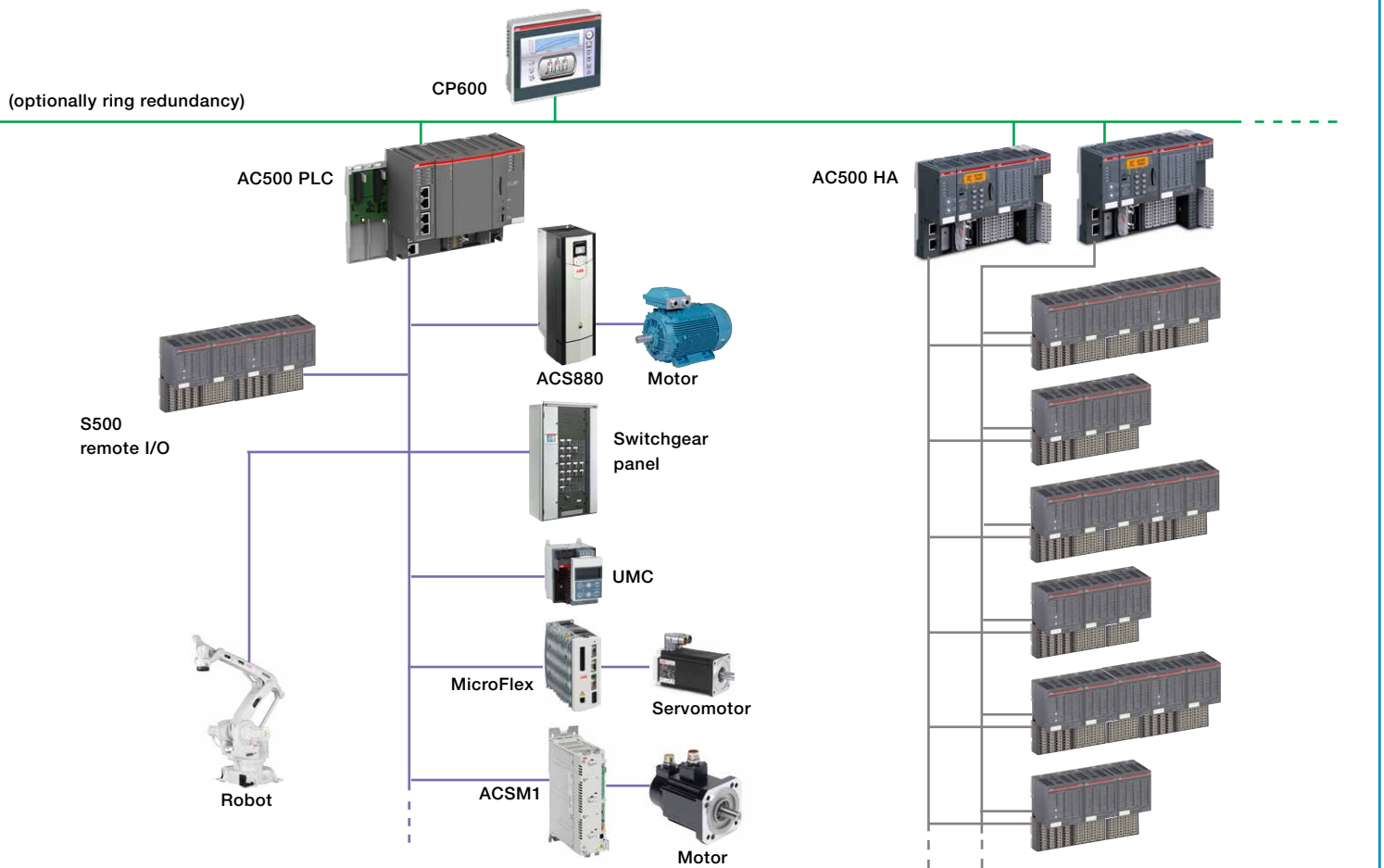

Application descriptions

AC500 High Availability

Performance is the key

Most downtime is caused by either human error or device malfunction which could be avoided with the AC500 high availability. Utilizing redundant CPUs and redundant distributed I/O Bus help to reduce any risk of total system failure thus enhancing system availability.

If the retention of critical data and the avoidance of downtime are important to your application then ABB AC500 high availability is the ideal solution.

What benefits can you expect from our AC500 high availability solution?

- Greater resource usage with no downtime in hardware/software failure with the redundant CPUs and redundant communication fieldbus CS31-Bus
- Cost efficiency and easy system maintenance through the use of standard hardware
- Only standard CPUs required, choose from PM573-ETH to PM592-ETH to achieve high availability
- 3 cycles or 50 ms changeover time
- Scalable: Up to total 7 redundant IO-Bus lines via CM574 make now also large applications possible.

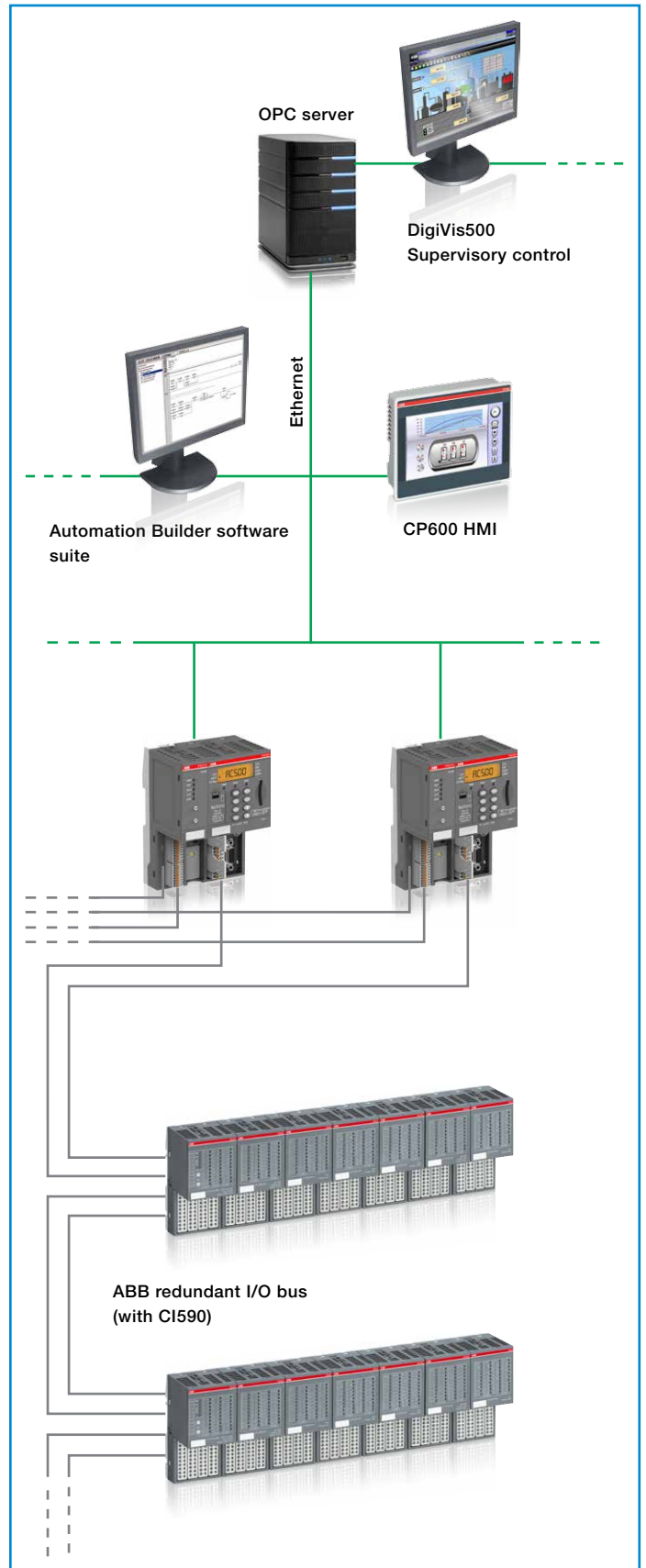

Application descriptions

Real-time Ethernet products

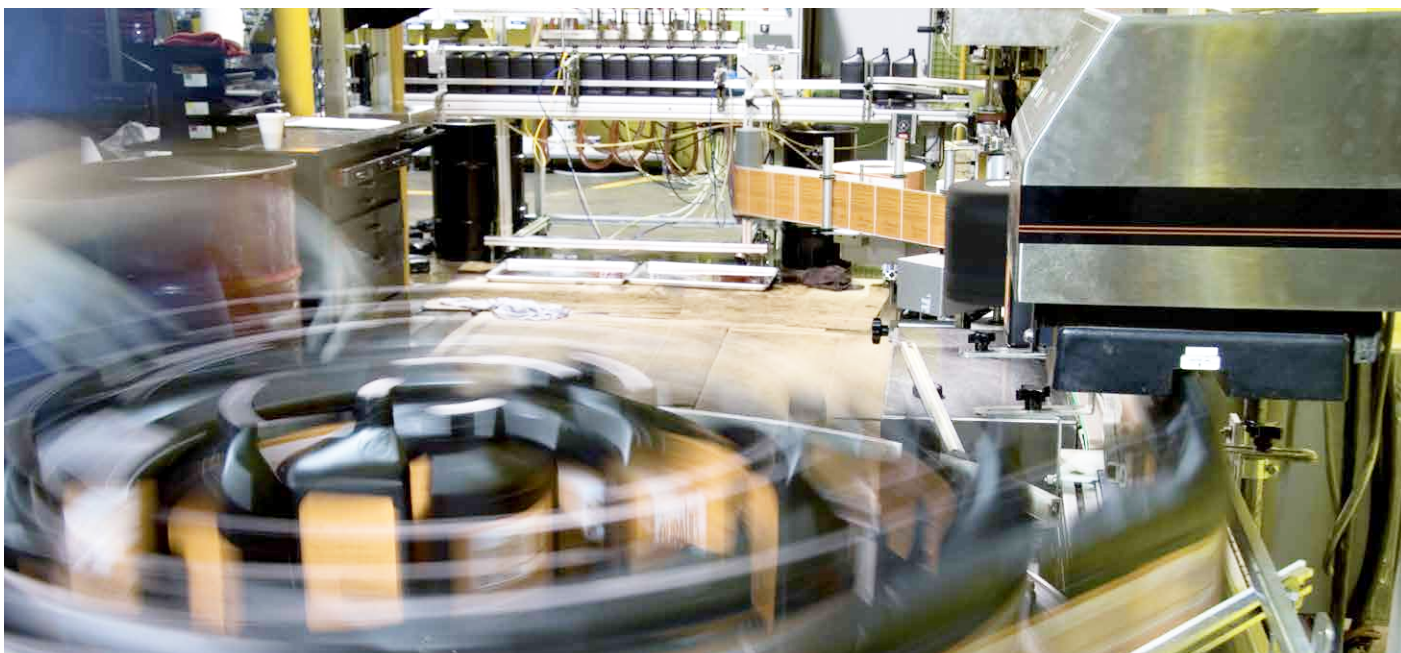

RT-Ethernet modules

The modules are available on two different communication protocols on Ethernet basis (PROFINET® I/O, EtherCAT®). Master couplers provide the connection of the AC500 CPUs to the remote I/O modules. Various interface modules offer the possibility to connect I/O modules decentralized to the real-time Ethernet networks.

Cam-switch functionality

Modules based on decentralized real-time EtherCAT® interface technology extended with integrated I/Os and programmed thanks to PLCopen® function blocks.

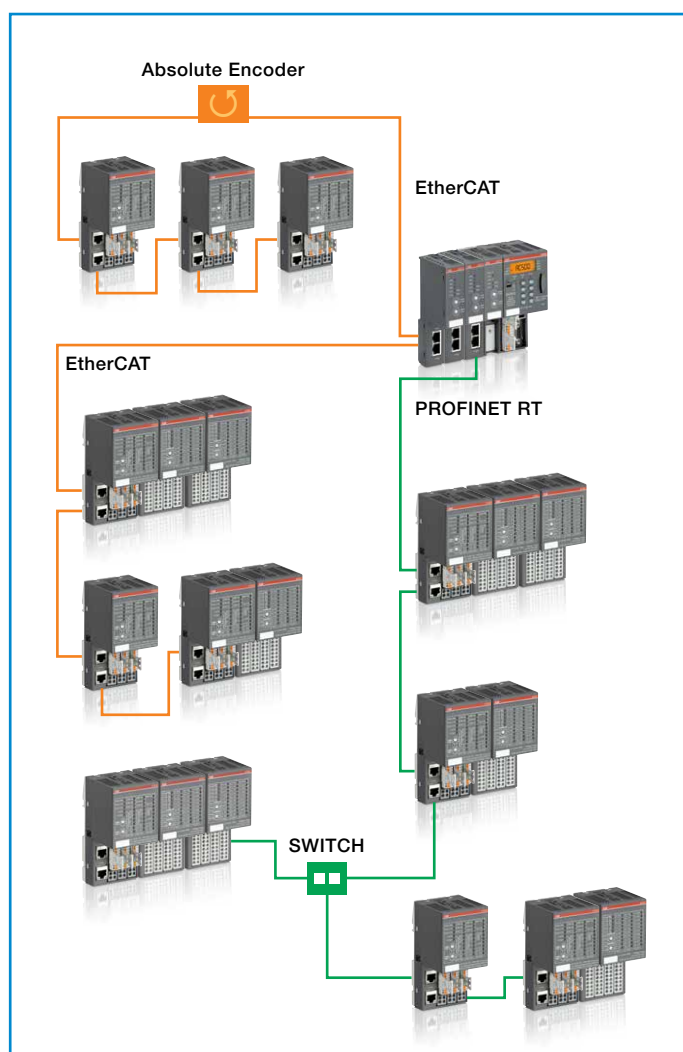

Application descriptions

MINT motion solutions – Real-time Ethernet systems

Advanced multi-axis machine controller

Machine control systems, requiring up to 16 axes of interpolation, can be implemented using the NextMove e100 family of motion controllers. NextMove e100 can coordinate 16 axes of interpolated motion in a single or multiple coordinate groups and command additional DSP 402 positioning drives via Powerlink, up to 24 axes in total. On-board communications include, RS232/485 (selectable), USB, CANopen® and Ethernet Powerlink or TCP/IP.

Mixed technology motion control

In addition to Powerlink axes, NextMove e100 supports 3 axes of analog control with incremental encoder feedback and 4 stepper axes, providing a mixed technology platform. Analog axes can be servo, vector, inverter or servo - hydraulic valves for example. Encoder inputs can be used as line-shaft inputs and all analog outputs can be used for general purpose functions.

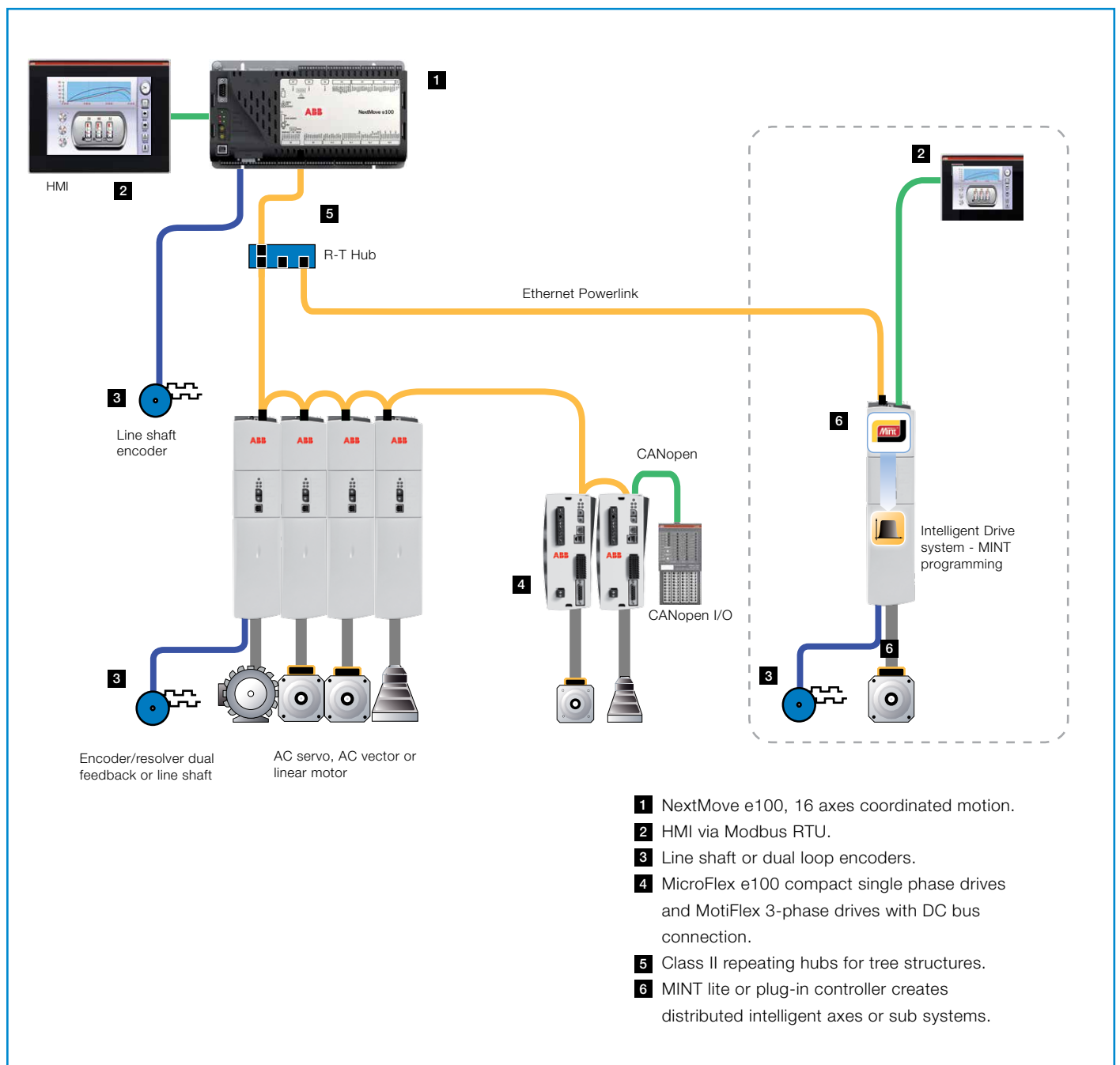

EtherCAT multi-axis coordinated motion

MicroFlex e150 is ideally partnered with ABB's AC500 PLC line with EtherCAT real-time performance or Modbus TCP control for less demanding applications. It also works with ABB's ACSM1 with FECA-01 EtherCAT module for higher power axes, along with the ACS355 and ACS850 drives. The MicroFlex e150 provides an industry solution with IEC 61131 programming and PLCOpen motion functions.

This popular high performance motion bus provides simple 'daisy chain' connection. It features two-port RJ45 Ethernet 100MB and as DS402 drive profile (IEC 61800-7 A) providing cyclic sync position and velocity, homing and touch probe. The MicroFlex e150 can be combined with the ABB AC500 PLC, drives.

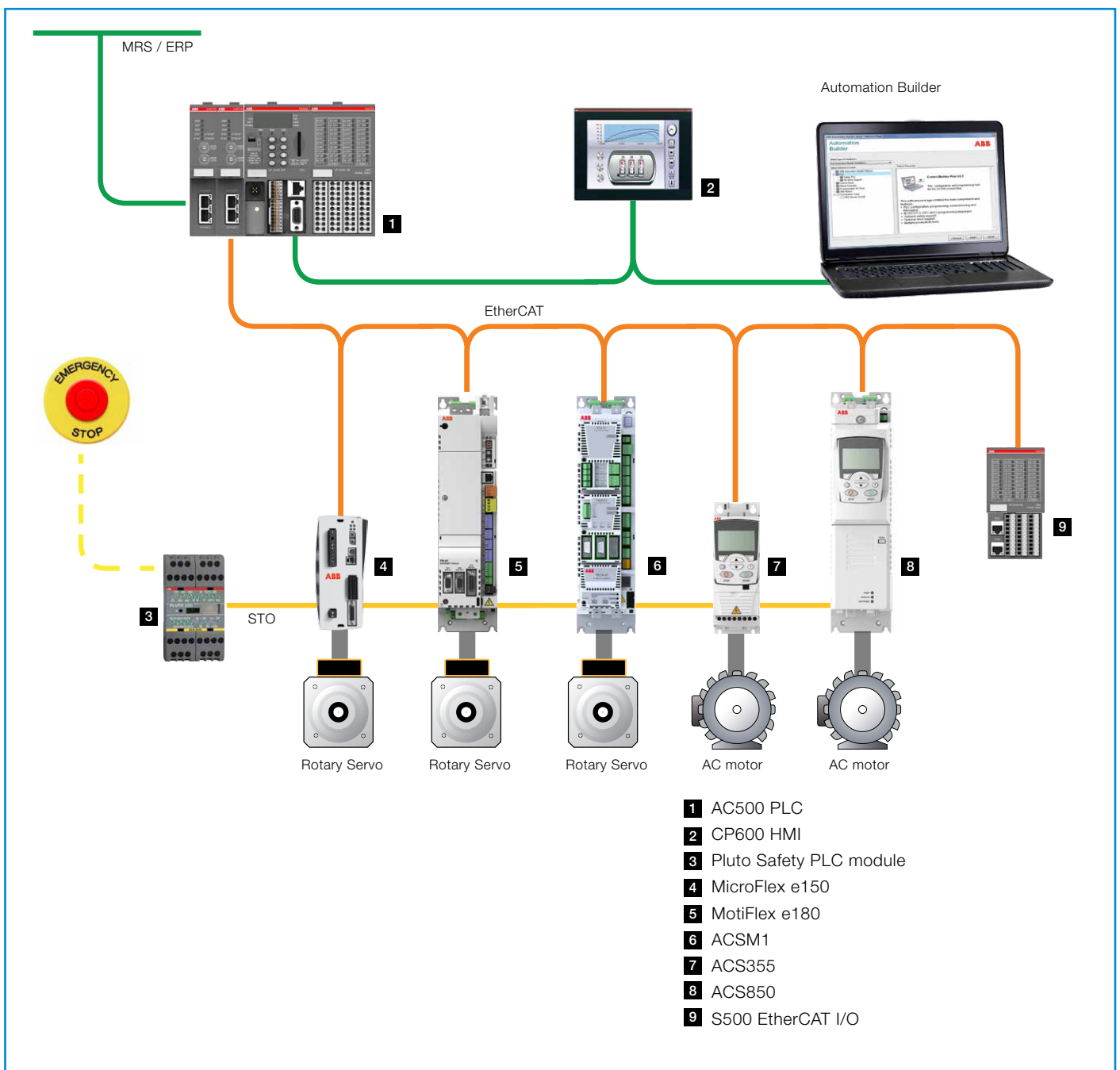

PLC Trainer AC500

Training packages with didactic models, software, teachware for schools and universities

Teach IEC61131-3 based programming with ABB AC500 PLCs

The ABB PLC Trainer AC500 addresses learners and students starting from the basic logic programming over motivating exercises up to Ethernet communication tasks and visualization with an integrated web server.

The included exercises range from the basic logical functions to practical samples like hot water heating using solar panels, parking bay monitoring or controlling gates with IR-remote.

Expansion possibilities like Motor or Traffic Light plug-on module and the Solar Tracking module will increase the motivation of the learners.

These training packages are built in cooperation with IKH Didactic Systems.

For more information please visit www.ikhds.com/abb

PLC Trainer AC500 basic package

Description:

- 1 PLC Trainer ABB AC500 with AC500-eCo CPU
- 1 Power supply 230 V AC / 24 V DC
- 1 IR-remote control without batteries
- 45 Learning cards 110 x 81 mm laminated in transparent storage box
- Programming software and 45 practical exercises and solutions on USB stick
- 1 Programming cable.



ABB PLC trainer AC500



ABB PLC trainer AC500 with plug-on traffic light module



ABB PLC trainer AC500 with plug-on motor module

AC500-eCo Starter kit

Getting started is as easy as 1, 2, 3

More functionality and enhanced scalability

AC500-eCo Starter kit

The AC500-eCo Starter kit helps you to get familiar with ABB AC500 PLC offerings and the engineering tool within a very short time. Learn how to connect and setup the components provided in the starter kit and how to program the PLC by means of several simple example applications. The starter kit comes with CPU, programming cable, digital input simulator, engineering tool and getting started handbook.

Easy to use

The AC500-eCo from ABB is a range of uniquely scalable PLCs offering you unrivalled cost effectiveness for modern industrial automation applications. The AC500-eCo integrates perfectly into the AC500 family - this provides you with the option to build customized solutions based on the standard S500 and S500-eCo I/O range.

Easy to learn

Offering all of the advantages you would expect from the AC500 family of devices, the AC500-eCo delivers an impressive set of powerful programming features. In addition, thanks to the fact that ABB uses a standard IEC61131-3 based programming system for the entire AC500 family, it is a snap to learn and configure.

Ordering details

Each kit consists of a CPU, programming cable, digital input simulator, engineering tool and "Getting started" handbook.

CPU module in the starter kit	Programming cable (included)	Type	Order code	Price	Weight (1 pce) kg
PM554-TP-ETH	Ethernet	TA574-D-T-ETH	1SAP186200R0004		1.400

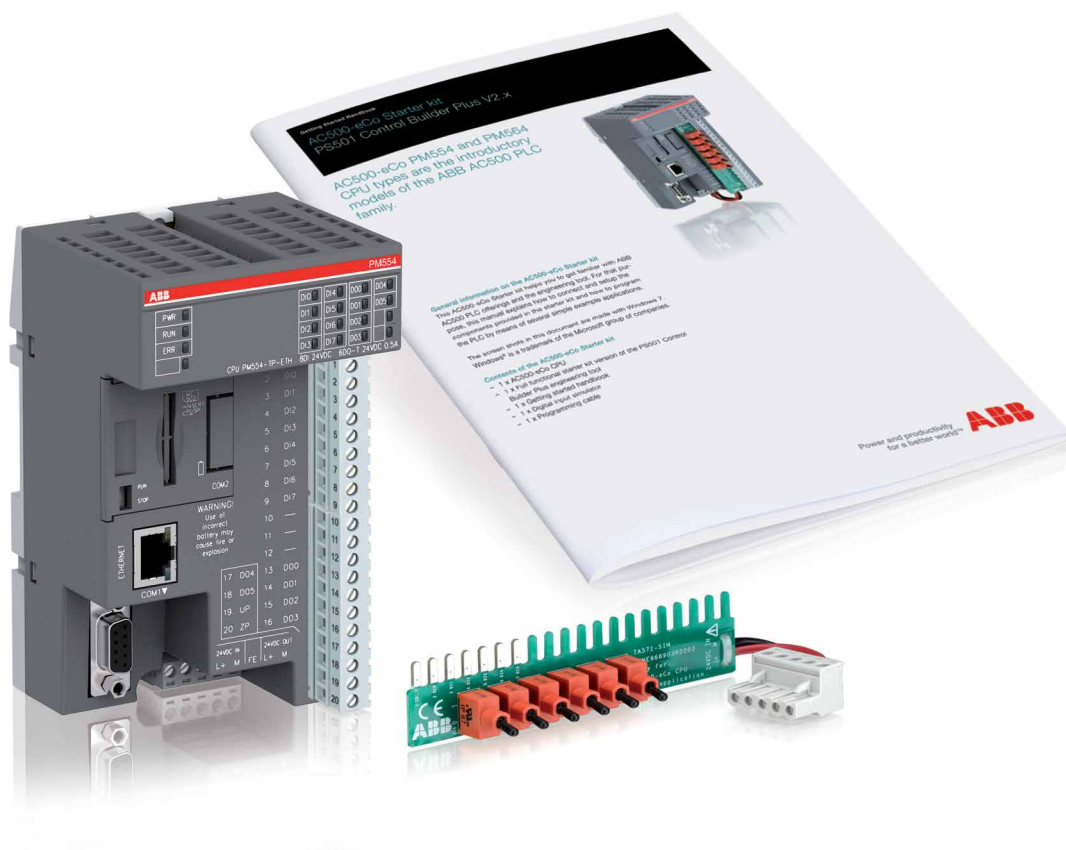

Additional information

Life cycle management for maximum return on investment

ABB's automation products business follows two main structures to ensure its customer's installations remain healthy:

1. ABB's product life cycle management model assures availability of services and support throughout the life cycle and a smooth transition to new technology at the end of the life cycle.

2. ABB's service offering follows a logical flow that spans the entire asset life cycle, from the moment a customer makes the first enquiry through to disposal and recycling of the product. At the heart of ABB's services is its product life cycle management model. All services and support available for ABB products are planned according to this model. Product specific life cycle plans are available for customers to help with maintenance planning and when deciding about upgrades, retrofits and replacements.

Product life cycle management model



The life cycle management model divides a product's life cycle into four phases: active, classic, limited and obsolete. Each phase has different implications for the end user in terms of services and support provided.

In the "active" phase the end user benefits from warranty options and a full range of life cycle services, spare parts and maintenance materials. This phase ends when the volume production of a particular product ends and the "classic" phase starts. In addition to offerings available in "active" phase, end users may migrate to new technology by using upgrade and retrofit solutions providing improved performance and extension of the life cycle.

After the "classic" phase products enter the "limited" phase and end users are recommended to start planning a transfer to new technology before product support ceases.

Spare part services continue as long as components and materials are available, and throughout the course of time the use of reconditioned parts increases.

A product is transferred to the "obsolete" phase when it is no longer possible to provide life cycle services within reasonable cost, or when ABB can no longer support the product technically, or the old technology is no longer available.

Benefits of product life cycle management

Product life cycle management maximizes the value of equipment and maintenance investments by:

- Ensuring spare part and competence availability throughout the life cycle
- Enabling efficient product support & maintenance for improved reliability
- Adding functionality to the initial product by following the upgrade path
- Providing a smooth transition to new technology at the end of a product's lifecycle
- Helping the end user to decide when an upgrade, retrofit or replacement is required.



The services offered by ABB's automation products span the entire asset lifetime, from the moment a customer makes the first enquiry to disposal and recycling of the product. Throughout the lifetime of an asset, ABB provides training, technical support and customized contracts. All of this is supported by one of the most extensive global sales and service networks.

Pre-purchase

ABB provides a range of services and support that help guide the customers to the right products for their applications.

Order and delivery

Orders can be placed through any ABB office or through ABB's channel partners. In some countries, ABB also offers a global online ordering and tracking system. ABB's sales and service network offers timely deliveries including express delivery.

Installation and commissioning

While many customers have the resource to undertake installation and commissioning on their own, ABB and its channel partners offer professional installation and start up services.

Operation and maintenance

From maintenance assessments, preventive maintenance and reconditioning to spare parts and repairs on-site or within its workshops, ABB has all the options covered to keep its customer's processes operational.

Upgrade and retrofit

ABB products can often be upgraded to the latest software or hardware to improve the performance of the application. Existing processes can be economically modernized by retrofitting the latest technology.

Replacement and recycling

ABB can advise on the best replacement products while ensuring that the products are disposed of in a way that meets all local environmental regulations.

Additional information

Approvals and certifications

Symbols and legends:

Standard product certified: product sticker wears approval mark when mandatory
 Approval submitted (roadmap available upon request)

Submission planned (roadmap available upon request)
 N.A. Not applicable N.N. Not needed













Symbol	Approvals					Shipping classification companies							Others
Abbreviation	CE	cUL	TR	C-Tick	KCC	ABS	BV	DNV	GL	LR	RINA	RMRS	ROHS
Name		Ordinary Locations	Hazardous Locations Class I Div 2	TR CU 004/2011 Formerly known as CQ1FR									
AI523	<input checked="" type="checkbox"/>	<input checked="" type="checkbox"/>	<input checked="" type="checkbox"/>	<input type="checkbox"/>	<input checked="" type="checkbox"/>	<input checked="" type="checkbox"/>	<input checked="" type="checkbox"/>	<input checked="" type="checkbox"/>	<input checked="" type="checkbox"/>	<input checked="" type="checkbox"/>	<input checked="" type="checkbox"/>	<input checked="" type="checkbox"/>	<input checked="" type="checkbox"/>
AI523-XC	<input checked="" type="checkbox"/>	<input checked="" type="checkbox"/>	<input checked="" type="checkbox"/>	<input type="checkbox"/>	<input checked="" type="checkbox"/>	<input checked="" type="checkbox"/>	<input checked="" type="checkbox"/>	<input checked="" type="checkbox"/>	<input checked="" type="checkbox"/>	<input checked="" type="checkbox"/>	<input checked="" type="checkbox"/>	<input checked="" type="checkbox"/>	<input checked="" type="checkbox"/>
AI531	<input checked="" type="checkbox"/>	<input checked="" type="checkbox"/>	<input checked="" type="checkbox"/>	<input type="checkbox"/>	<input checked="" type="checkbox"/>	<input checked="" type="checkbox"/>	<input checked="" type="checkbox"/>	<input checked="" type="checkbox"/>	<input checked="" type="checkbox"/>	<input checked="" type="checkbox"/>	<input checked="" type="checkbox"/>	<input checked="" type="checkbox"/>	<input checked="" type="checkbox"/>
AI531-XC	<input checked="" type="checkbox"/>	<input checked="" type="checkbox"/>	<input checked="" type="checkbox"/>	<input type="checkbox"/>	<input checked="" type="checkbox"/>	<input checked="" type="checkbox"/>	<input checked="" type="checkbox"/>	<input checked="" type="checkbox"/>	<input checked="" type="checkbox"/>	<input checked="" type="checkbox"/>	<input checked="" type="checkbox"/>	<input checked="" type="checkbox"/>	<input checked="" type="checkbox"/>
AI561	<input checked="" type="checkbox"/>	<input checked="" type="checkbox"/>	<input checked="" type="checkbox"/>	<input type="checkbox"/>	<input checked="" type="checkbox"/>	<input checked="" type="checkbox"/>	<input checked="" type="checkbox"/>	<input checked="" type="checkbox"/>	<input checked="" type="checkbox"/>	<input checked="" type="checkbox"/>	<input checked="" type="checkbox"/>	<input checked="" type="checkbox"/>	<input checked="" type="checkbox"/>
AI562	<input checked="" type="checkbox"/>	<input checked="" type="checkbox"/>	<input checked="" type="checkbox"/>	<input type="checkbox"/>	<input checked="" type="checkbox"/>	<input checked="" type="checkbox"/>	<input checked="" type="checkbox"/>	<input checked="" type="checkbox"/>	<input checked="" type="checkbox"/>	<input checked="" type="checkbox"/>	<input checked="" type="checkbox"/>	<input checked="" type="checkbox"/>	<input checked="" type="checkbox"/>
AI563	<input checked="" type="checkbox"/>	<input checked="" type="checkbox"/>	<input checked="" type="checkbox"/>	<input type="checkbox"/>	<input checked="" type="checkbox"/>	<input checked="" type="checkbox"/>	<input checked="" type="checkbox"/>	<input checked="" type="checkbox"/>	<input checked="" type="checkbox"/>	<input checked="" type="checkbox"/>	<input checked="" type="checkbox"/>	<input checked="" type="checkbox"/>	<input checked="" type="checkbox"/>
AI581-S	<input checked="" type="checkbox"/>	<input checked="" type="checkbox"/>	<input checked="" type="checkbox"/>	<input type="checkbox"/>	<input checked="" type="checkbox"/>	<input checked="" type="checkbox"/>	<input checked="" type="checkbox"/>	<input checked="" type="checkbox"/>	<input checked="" type="checkbox"/>	<input checked="" type="checkbox"/>	<input checked="" type="checkbox"/>	<input checked="" type="checkbox"/>	<input checked="" type="checkbox"/>
AI581-S-XC	<input checked="" type="checkbox"/>	<input checked="" type="checkbox"/>	<input checked="" type="checkbox"/>	<input type="checkbox"/>	<input checked="" type="checkbox"/>	<input checked="" type="checkbox"/>	<input checked="" type="checkbox"/>	<input checked="" type="checkbox"/>	<input checked="" type="checkbox"/>	<input checked="" type="checkbox"/>	<input checked="" type="checkbox"/>	<input checked="" type="checkbox"/>	<input checked="" type="checkbox"/>
AO523	<input checked="" type="checkbox"/>	<input checked="" type="checkbox"/>	<input checked="" type="checkbox"/>	<input type="checkbox"/>	<input checked="" type="checkbox"/>	<input checked="" type="checkbox"/>	<input checked="" type="checkbox"/>	<input checked="" type="checkbox"/>	<input checked="" type="checkbox"/>	<input checked="" type="checkbox"/>	<input checked="" type="checkbox"/>	<input checked="" type="checkbox"/>	<input checked="" type="checkbox"/>
AO523-XC	<input checked="" type="checkbox"/>	<input checked="" type="checkbox"/>	<input checked="" type="checkbox"/>	<input type="checkbox"/>	<input checked="" type="checkbox"/>	<input checked="" type="checkbox"/>	<input checked="" type="checkbox"/>	<input checked="" type="checkbox"/>	<input checked="" type="checkbox"/>	<input checked="" type="checkbox"/>	<input checked="" type="checkbox"/>	<input checked="" type="checkbox"/>	<input checked="" type="checkbox"/>
AO561	<input checked="" type="checkbox"/>	<input checked="" type="checkbox"/>	<input checked="" type="checkbox"/>	<input type="checkbox"/>	<input checked="" type="checkbox"/>	<input checked="" type="checkbox"/>	<input checked="" type="checkbox"/>	<input checked="" type="checkbox"/>	<input checked="" type="checkbox"/>	<input checked="" type="checkbox"/>	<input checked="" type="checkbox"/>	<input checked="" type="checkbox"/>	<input checked="" type="checkbox"/>
AX521	<input checked="" type="checkbox"/>	<input checked="" type="checkbox"/>	<input checked="" type="checkbox"/>	<input type="checkbox"/>	<input checked="" type="checkbox"/>	<input checked="" type="checkbox"/>	<input checked="" type="checkbox"/>	<input checked="" type="checkbox"/>	<input checked="" type="checkbox"/>	<input checked="" type="checkbox"/>	<input checked="" type="checkbox"/>	<input checked="" type="checkbox"/>	<input checked="" type="checkbox"/>
AX521-XC	<input checked="" type="checkbox"/>	<input checked="" type="checkbox"/>	<input checked="" type="checkbox"/>	<input type="checkbox"/>	<input checked="" type="checkbox"/>	<input checked="" type="checkbox"/>	<input checked="" type="checkbox"/>	<input checked="" type="checkbox"/>	<input checked="" type="checkbox"/>	<input checked="" type="checkbox"/>	<input checked="" type="checkbox"/>	<input checked="" type="checkbox"/>	<input checked="" type="checkbox"/>
AX522	<input checked="" type="checkbox"/>	<input checked="" type="checkbox"/>	<input checked="" type="checkbox"/>	<input type="checkbox"/>	<input checked="" type="checkbox"/>	<input checked="" type="checkbox"/>	<input checked="" type="checkbox"/>	<input checked="" type="checkbox"/>	<input checked="" type="checkbox"/>	<input checked="" type="checkbox"/>	<input checked="" type="checkbox"/>	<input checked="" type="checkbox"/>	<input checked="" type="checkbox"/>
AX522-XC	<input checked="" type="checkbox"/>	<input checked="" type="checkbox"/>	<input checked="" type="checkbox"/>	<input type="checkbox"/>	<input checked="" type="checkbox"/>	<input checked="" type="checkbox"/>	<input checked="" type="checkbox"/>	<input checked="" type="checkbox"/>	<input checked="" type="checkbox"/>	<input checked="" type="checkbox"/>	<input checked="" type="checkbox"/>	<input checked="" type="checkbox"/>	<input checked="" type="checkbox"/>
AX561	<input checked="" type="checkbox"/>	<input checked="" type="checkbox"/>	<input checked="" type="checkbox"/>	<input type="checkbox"/>	<input checked="" type="checkbox"/>	<input checked="" type="checkbox"/>	<input checked="" type="checkbox"/>	<input checked="" type="checkbox"/>	<input checked="" type="checkbox"/>	<input checked="" type="checkbox"/>	<input checked="" type="checkbox"/>	<input checked="" type="checkbox"/>	<input checked="" type="checkbox"/>
CD522	<input checked="" type="checkbox"/>	<input checked="" type="checkbox"/>	<input checked="" type="checkbox"/>	<input type="checkbox"/>	<input checked="" type="checkbox"/>	<input checked="" type="checkbox"/>	<input checked="" type="checkbox"/>	<input checked="" type="checkbox"/>	<input checked="" type="checkbox"/>	<input checked="" type="checkbox"/>	<input checked="" type="checkbox"/>	<input checked="" type="checkbox"/>	<input checked="" type="checkbox"/>
CD522-XC	<input checked="" type="checkbox"/>	<input checked="" type="checkbox"/>	<input checked="" type="checkbox"/>	<input type="checkbox"/>	<input checked="" type="checkbox"/>	<input checked="" type="checkbox"/>	<input checked="" type="checkbox"/>	<input checked="" type="checkbox"/>	<input checked="" type="checkbox"/>	<input checked="" type="checkbox"/>	<input checked="" type="checkbox"/>	<input checked="" type="checkbox"/>	<input checked="" type="checkbox"/>
CI501-PNIO	<input checked="" type="checkbox"/>	<input checked="" type="checkbox"/>	<input checked="" type="checkbox"/>	<input type="checkbox"/>	<input checked="" type="checkbox"/>	<input checked="" type="checkbox"/>	<input checked="" type="checkbox"/>	<input checked="" type="checkbox"/>	<input checked="" type="checkbox"/>	<input checked="" type="checkbox"/>	<input checked="" type="checkbox"/>	<input checked="" type="checkbox"/>	<input checked="" type="checkbox"/>
CI501-PNIO-XC	<input checked="" type="checkbox"/>	<input checked="" type="checkbox"/>	<input checked="" type="checkbox"/>	<input type="checkbox"/>	<input checked="" type="checkbox"/>	<input checked="" type="checkbox"/>	<input checked="" type="checkbox"/>	<input checked="" type="checkbox"/>	<input checked="" type="checkbox"/>	<input checked="" type="checkbox"/>	<input checked="" type="checkbox"/>	<input checked="" type="checkbox"/>	<input checked="" type="checkbox"/>
CI502-PNIO	<input checked="" type="checkbox"/>	<input checked="" type="checkbox"/>	<input checked="" type="checkbox"/>	<input type="checkbox"/>	<input checked="" type="checkbox"/>	<input checked="" type="checkbox"/>	<input checked="" type="checkbox"/>	<input checked="" type="checkbox"/>	<input checked="" type="checkbox"/>	<input checked="" type="checkbox"/>	<input checked="" type="checkbox"/>	<input checked="" type="checkbox"/>	<input checked="" type="checkbox"/>
CI502-PNIO-XC	<input checked="" type="checkbox"/>	<input checked="" type="checkbox"/>	<input checked="" type="checkbox"/>	<input type="checkbox"/>	<input checked="" type="checkbox"/>	<input checked="" type="checkbox"/>	<input checked="" type="checkbox"/>	<input checked="" type="checkbox"/>	<input checked="" type="checkbox"/>	<input checked="" type="checkbox"/>	<input checked="" type="checkbox"/>	<input checked="" type="checkbox"/>	<input checked="" type="checkbox"/>
CI504-PNIO	<input checked="" type="checkbox"/>	<input checked="" type="checkbox"/>	<input checked="" type="checkbox"/>	<input type="checkbox"/>	<input checked="" type="checkbox"/>	<input checked="" type="checkbox"/>	<input checked="" type="checkbox"/>	<input checked="" type="checkbox"/>	<input checked="" type="checkbox"/>	<input checked="" type="checkbox"/>	<input checked="" type="checkbox"/>	<input checked="" type="checkbox"/>	<input checked="" type="checkbox"/>
CI504-PNIO-XC	<input checked="" type="checkbox"/>	<input checked="" type="checkbox"/>	<input checked="" type="checkbox"/>	<input type="checkbox"/>	<input checked="" type="checkbox"/>	<input checked="" type="checkbox"/>	<input checked="" type="checkbox"/>	<input checked="" type="checkbox"/>	<input checked="" type="checkbox"/>	<input checked="" type="checkbox"/>	<input checked="" type="checkbox"/>	<input checked="" type="checkbox"/>	<input checked="" type="checkbox"/>
CI506-PNIO	<input checked="" type="checkbox"/>	<input checked="" type="checkbox"/>	<input checked="" type="checkbox"/>	<input type="checkbox"/>	<input checked="" type="checkbox"/>	<input checked="" type="checkbox"/>	<input checked="" type="checkbox"/>	<input checked="" type="checkbox"/>	<input checked="" type="checkbox"/>	<input checked="" type="checkbox"/>	<input checked="" type="checkbox"/>	<input checked="" type="checkbox"/>	<input checked="" type="checkbox"/>
CI506-PNIO-XC	<input checked="" type="checkbox"/>	<input checked="" type="checkbox"/>	<input checked="" type="checkbox"/>	<input type="checkbox"/>	<input checked="" type="checkbox"/>	<input checked="" type="checkbox"/>	<input checked="" type="checkbox"/>	<input checked="" type="checkbox"/>	<input checked="" type="checkbox"/>	<input checked="" type="checkbox"/>	<input checked="" type="checkbox"/>	<input checked="" type="checkbox"/>	<input checked="" type="checkbox"/>
CI511-ETHCAT	<input checked="" type="checkbox"/>	<input checked="" type="checkbox"/>	<input checked="" type="checkbox"/>	<input type="checkbox"/>	<input checked="" type="checkbox"/>	<input checked="" type="checkbox"/>	<input checked="" type="checkbox"/>	<input checked="" type="checkbox"/>	<input checked="" type="checkbox"/>	<input checked="" type="checkbox"/>	<input checked="" type="checkbox"/>	<input checked="" type="checkbox"/>	<input checked="" type="checkbox"/>
CI512-ETHCAT	<input checked="" type="checkbox"/>	<input checked="" type="checkbox"/>	<input checked="" type="checkbox"/>	<input type="checkbox"/>	<input checked="" type="checkbox"/>	<input checked="" type="checkbox"/>	<input checked="" type="checkbox"/>	<input checked="" type="checkbox"/>	<input checked="" type="checkbox"/>	<input checked="" type="checkbox"/>	<input checked="" type="checkbox"/>	<input checked="" type="checkbox"/>	<input checked="" type="checkbox"/>
CI541-DP	<input checked="" type="checkbox"/>	<input checked="" type="checkbox"/>	<input checked="" type="checkbox"/>	<input type="checkbox"/>	<input checked="" type="checkbox"/>	<input checked="" type="checkbox"/>	<input checked="" type="checkbox"/>	<input checked="" type="checkbox"/>	<input checked="" type="checkbox"/>	<input checked="" type="checkbox"/>	<input checked="" type="checkbox"/>	<input checked="" type="checkbox"/>	<input checked="" type="checkbox"/>
CI541-DP-XC	<input checked="" type="checkbox"/>	<input checked="" type="checkbox"/>	<input checked="" type="checkbox"/>	<input type="checkbox"/>	<input checked="" type="checkbox"/>	<input checked="" type="checkbox"/>	<input checked="" type="checkbox"/>	<input checked="" type="checkbox"/>	<input checked="" type="checkbox"/>	<input checked="" type="checkbox"/>	<input checked="" type="checkbox"/>	<input checked="" type="checkbox"/>	<input checked="" type="checkbox"/>
CI542-DP	<input checked="" type="checkbox"/>	<input checked="" type="checkbox"/>	<input checked="" type="checkbox"/>	<input type="checkbox"/>	<input checked="" type="checkbox"/>	<input checked="" type="checkbox"/>	<input checked="" type="checkbox"/>	<input checked="" type="checkbox"/>	<input checked="" type="checkbox"/>	<input checked="" type="checkbox"/>	<input checked="" type="checkbox"/>	<input checked="" type="checkbox"/>	<input checked="" type="checkbox"/>
CI542-DP-XC	<input checked="" type="checkbox"/>	<input checked="" type="checkbox"/>	<input checked="" type="checkbox"/>	<input type="checkbox"/>	<input checked="" type="checkbox"/>	<input checked="" type="checkbox"/>	<input checked="" type="checkbox"/>	<input checked="" type="checkbox"/>	<input checked="" type="checkbox"/>	<input checked="" type="checkbox"/>	<input checked="" type="checkbox"/>	<input checked="" type="checkbox"/>	<input checked="" type="checkbox"/>
CI581-CN	<input checked="" type="checkbox"/>	<input checked="" type="checkbox"/>	<input checked="" type="checkbox"/>	<input type="checkbox"/>	<input checked="" type="checkbox"/>	<input checked="" type="checkbox"/>	<input checked="" type="checkbox"/>	<input checked="" type="checkbox"/>	<input checked="" type="checkbox"/>	<input checked="" type="checkbox"/>	<input checked="" type="checkbox"/>	<input checked="" type="checkbox"/>	<input checked="" type="checkbox"/>
CI581-CN-XC	<input checked="" type="checkbox"/>	<input checked="" type="checkbox"/>	<input checked="" type="checkbox"/>	<input type="checkbox"/>	<input checked="" type="checkbox"/>	<input checked="" type="checkbox"/>	<input checked="" type="checkbox"/>	<input checked="" type="checkbox"/>	<input checked="" type="checkbox"/>	<input checked="" type="checkbox"/>	<input checked="" type="checkbox"/>	<input checked="" type="checkbox"/>	<input checked="" type="checkbox"/>
CI582-CN	<input checked="" type="checkbox"/>	<input checked="" type="checkbox"/>	<input checked="" type="checkbox"/>	<input type="checkbox"/>	<input checked="" type="checkbox"/>	<input checked="" type="checkbox"/>	<input checked="" type="checkbox"/>	<input checked="" type="checkbox"/>	<input checked="" type="checkbox"/>	<input checked="" type="checkbox"/>	<input checked="" type="checkbox"/>	<input checked="" type="checkbox"/>	<input checked="" type="checkbox"/>
CI582-CN-XC	<input checked="" type="checkbox"/>	<input checked="" type="checkbox"/>	<input checked="" type="checkbox"/>	<input type="checkbox"/>	<input checked="" type="checkbox"/>	<input checked="" type="checkbox"/>	<input checked="" type="checkbox"/>	<input checked="" type="checkbox"/>	<input checked="" type="checkbox"/>	<input checked="" type="checkbox"/>	<input checked="" type="checkbox"/>	<input checked="" type="checkbox"/>	<input checked="" type="checkbox"/>
CI590-CS31-HA	<input checked="" type="checkbox"/>	<input checked="" type="checkbox"/>	<input checked="" type="checkbox"/>	<input type="checkbox"/>	<input checked="" type="checkbox"/>	<input checked="" type="checkbox"/>	<input checked="" type="checkbox"/>	<input checked="" type="checkbox"/>	<input checked="" type="checkbox"/>	<input checked="" type="checkbox"/>	<input checked="" type="checkbox"/>	<input checked="" type="checkbox"/>	<input checked="" type="checkbox"/>
CI590-CS31-HA-XC	<input checked="" type="checkbox"/>	<input checked="" type="checkbox"/>	<input checked="" type="checkbox"/>	<input type="checkbox"/>	<input checked="" type="checkbox"/>	<input checked="" type="checkbox"/>	<input checked="" type="checkbox"/>	<input checked="" type="checkbox"/>	<input checked="" type="checkbox"/>	<input checked="" type="checkbox"/>	<input checked="" type="checkbox"/>	<input checked="" type="checkbox"/>	<input checked="" type="checkbox"/>
CI592-CS31	<input checked="" type="checkbox"/>	<input checked="" type="checkbox"/>	<input checked="" type="checkbox"/>	<input type="checkbox"/>	<input checked="" type="checkbox"/>	<input checked="" type="checkbox"/>	<input checked="" type="checkbox"/>	<input checked="" type="checkbox"/>	<input checked="" type="checkbox"/>	<input checked="" type="checkbox"/>	<input checked="" type="checkbox"/>	<input checked="" type="checkbox"/>	<input checked="" type="checkbox"/>
CI592-CS31-XC	<input checked="" type="checkbox"/>	<input checked="" type="checkbox"/>	<input checked="" type="checkbox"/>	<input type="checkbox"/>	<input checked="" type="checkbox"/>	<input checked="" type="checkbox"/>	<input checked="" type="checkbox"/>	<input checked="" type="checkbox"/>	<input checked="" type="checkbox"/>	<input checked="" type="checkbox"/>	<input checked="" type="checkbox"/>	<input checked="" type="checkbox"/>	<input checked="" type="checkbox"/>
CM572-DP	<input checked="" type="checkbox"/>	<input checked="" type="checkbox"/>	<input checked="" type="checkbox"/>	<input type="checkbox"/>	<input checked="" type="checkbox"/>	<input checked="" type="checkbox"/>	<input checked="" type="checkbox"/>	<input checked="" type="checkbox"/>	<input checked="" type="checkbox"/>	<input checked="" type="checkbox"/>	<input checked="" type="checkbox"/>	<input checked="" type="checkbox"/>	<input checked="" type="checkbox"/>
CM572-DP-XC	<input checked="" type="checkbox"/>	<input checked="" type="checkbox"/>	<input checked="" type="checkbox"/>	<input type="checkbox"/>	<input checked="" type="checkbox"/>	<input checked="" type="checkbox"/>	<input checked="" type="checkbox"/>	<input checked="" type="checkbox"/>	<input checked="" type="checkbox"/>	<input checked="" type="checkbox"/>	<input checked="" type="checkbox"/>	<input checked="" type="checkbox"/>	<input checked="" type="checkbox"/>
CM574-RCOM	<input checked="" type="checkbox"/>	<input checked="" type="checkbox"/>	<input checked="" type="checkbox"/>	<input type="checkbox"/>	<input checked="" type="checkbox"/>	<input checked="" type="checkbox"/>	<input checked="" type="checkbox"/>	<input checked="" type="checkbox"/>	<input checked="" type="checkbox"/>	<input checked="" type="checkbox"/>	<input checked="" type="checkbox"/>	<input checked="" type="checkbox"/>	<input checked="" type="checkbox"/>
CM574-RS	<input checked="" type="checkbox"/>	<input checked="" type="checkbox"/>	<input checked="" type="checkbox"/>	<input type="checkbox"/>	<input checked="" type="checkbox"/>	<input checked="" type="checkbox"/>	<input checked="" type="checkbox"/>	<input checked="" type="checkbox"/>	<input checked="" type="checkbox"/>	<input checked="" type="checkbox"/>	<input checked="" type="checkbox"/>	<input checked="" type="checkbox"/>	<input checked="" type="checkbox"/>
CM578-CN	<input checked="" type="checkbox"/>	<input checked="" type="checkbox"/>	<input checked="" type="checkbox"/>	<input type="checkbox"/>	<input checked="" type="checkbox"/>	<input checked="" type="checkbox"/>	<input checked="" type="checkbox"/>	<input checked="" type="checkbox"/>	<input checked="" type="checkbox"/>	<input checked="" type="checkbox"/>	<input checked="" type="checkbox"/>	<input checked="" type="checkbox"/>	<input checked="" type="checkbox"/>
CM578-CN-XC	<input checked="" type="checkbox"/>	<input checked="" type="checkbox"/>	<input checked="" type="checkbox"/>	<input type="checkbox"/>	<input checked="" type="checkbox"/>	<input checked="" type="checkbox"/>	<input checked="" type="checkbox"/>	<input checked="" type="checkbox"/>	<input checked="" type="checkbox"/>	<input checked="" type="checkbox"/>	<input checked="" type="checkbox"/>	<input checked="" type="checkbox"/>	<input checked="" type="checkbox"/>
CM579-ETHCAT	<input checked="" type="checkbox"/>	<input checked="" type="checkbox"/>	<input checked="" type="checkbox"/>	<input type="checkbox"/>	<input checked="" type="checkbox"/>	<input checked="" type="checkbox"/>	<input checked="" type="checkbox"/>	<input checked="" type="checkbox"/>	<input checked="" type="checkbox"/>	<input checked="" type="checkbox"/>	<input checked="" type="checkbox"/>	<input checked="" type="checkbox"/>	<input checked="" type="checkbox"/>
CM579-PNIO	<input checked="" type="checkbox"/>	<input checked="" type="checkbox"/>	<input checked="" type="checkbox"/>	<input type="checkbox"/>	<input checked="" type="checkbox"/>	<input checked="" type="checkbox"/>	<input checked="" type="checkbox"/>	<input checked="" type="checkbox"/>	<input checked="" type="checkbox"/>	<input checked="" type="checkbox"/>	<input checked="" type="checkbox"/>	<input checked="" type="checkbox"/>	<input checked="" type="checkbox"/>
CM579-PNIO-XC	<input checked="" type="checkbox"/>	<input checked="" type="checkbox"/>	<input checked="" type="checkbox"/>	<input type="checkbox"/>	<input checked="" type="checkbox"/>	<input checked="" type="checkbox"/>	<input checked="" type="checkbox"/>	<input checked="" type="checkbox"/>	<input checked="" type="checkbox"/>	<input checked="" type="checkbox"/>	<input checked="" type="checkbox"/>	<input checked="" type="checkbox"/>	<input checked="" type="checkbox"/>
CM588-CN	<input checked="" type="checkbox"/>	<input checked="" type="checkbox"/>	<input checked="" type="checkbox"/>	<input type="checkbox"/>	<input checked="" type="checkbox"/>	<input checked="" type="checkbox"/>	<input checked="" type="checkbox"/>	<input checked="" type="checkbox"/>	<input checked="" type="checkbox"/>	<input checked="" type="checkbox"/>	<input checked="" type="checkbox"/>	<input checked="" type="checkbox"/>	<input checked="" type="checkbox"/>
CM588-CN-XC	<input checked="" type="checkbox"/>	<input checked="" type="checkbox"/>	<input checked="" type="checkbox"/>	<input type="checkbox"/>	<input checked="" type="checkbox"/>	<input checked="" type="checkbox"/>	<input checked="" type="checkbox"/>	<input checked="" type="checkbox"/>	<input checked="" type="checkbox"/>	<input checked="" type="checkbox"/>	<input checked="" type="checkbox"/>	<input checked="" type="checkbox"/>	<input checked="" type="checkbox"/>
CM589-PNIO	<input checked="" type="checkbox"/>	<input checked="" type="checkbox"/>	<input type="checkbox"/>	<input type="checkbox"/>	<input checked="" type="checkbox"/>	<input checked="" type="checkbox"/>	<input checked="" type="checkbox"/>	<input checked="" type="checkbox"/>	<input checked="" type="checkbox"/>	<input checked="" type="checkbox"/>	<input checked="" type="checkbox"/>	<input checked="" type="checkbox"/>	<input checked="" type="checkbox"/>
CM589-PNIO-XC	<input checked="" type="checkbox"/>	<input checked="" type="checkbox"/>	<input type="checkbox"/>	<input type="checkbox"/>	<input checked="" type="checkbox"/>	<input checked="" type="checkbox"/>	<input checked="" type="checkbox"/>	<input checked="" type="checkbox"/>	<input checked="" type="checkbox"/>	<input checked="" type="checkbox"/>	<input checked="" type="checkbox"/>	<input checked="" type="checkbox"/>	<input checked="" type="checkbox"/>
CM597-ETH	<input checked="" type="checkbox"/>	<input checked="" type="checkbox"/>	<input type="checkbox"/>	<input type="checkbox"/>	<input checked="" type="checkbox"/>	<input checked="" type="checkbox"/>	<input checked="" type="checkbox"/>	<input checked="" type="checkbox"/>	<input checked="" type="checkbox"/>	<input checked="" type="checkbox"/>	<input checked="" type="checkbox"/>	<input checked="" type="checkbox"/>	<input checked="" type="checkbox"/>
CM597-ETH-XC	<input checked="" type="checkbox"/>	<input checked="" type="checkbox"/>	<input type="checkbox"/>	<input type="checkbox"/>	<input checked="" type="checkbox"/>	<input checked="" type="checkbox"/>	<input checked="" type="checkbox"/>	<input checked="" type="checkbox"/>	<input checked="" type="checkbox"/>	<input checked="" type="checkbox"/>	<input checked="" type="checkbox"/>	<input checked="" type="checkbox"/>	<input checked="" type="checkbox"/>

Additional information

Approvals and certifications

Symbols and legends:  Standard product certified: product sticker wears approval mark when mandatory
 Approval submitted (roadmap available upon request)

 Submission planned (roadmap available upon request)
 N.A. Not applicable N.N. Not needed

Symbol	Approvals						Shipping classification companies							Others
														
Abbreviation	CE	cUL	TR	C-Tick	KCC	ABS	BV	DNV	GL	LR	RINA	RMRS	ROHS	
Name		Ordinary Locations Hazardous Locations Class I Div. 2	TR CU 004/2011 Formerly known as GOST R											
CP620	<input checked="" type="checkbox"/>	<input checked="" type="checkbox"/>	<input checked="" type="checkbox"/>	<input type="checkbox"/>	<input checked="" type="checkbox"/>	<input checked="" type="checkbox"/>		<input checked="" type="checkbox"/>	<input checked="" type="checkbox"/>				<input checked="" type="checkbox"/>	
CP620-WEB	<input checked="" type="checkbox"/>	<input checked="" type="checkbox"/>	<input checked="" type="checkbox"/>	<input type="checkbox"/>	<input checked="" type="checkbox"/>	<input checked="" type="checkbox"/>		<input checked="" type="checkbox"/>	<input checked="" type="checkbox"/>				<input checked="" type="checkbox"/>	
CP630	<input checked="" type="checkbox"/>	<input checked="" type="checkbox"/>	<input checked="" type="checkbox"/>	<input type="checkbox"/>	<input checked="" type="checkbox"/>	<input checked="" type="checkbox"/>		<input checked="" type="checkbox"/>	<input checked="" type="checkbox"/>				<input checked="" type="checkbox"/>	
CP630-WEB	<input checked="" type="checkbox"/>	<input checked="" type="checkbox"/>	<input checked="" type="checkbox"/>	<input type="checkbox"/>	<input checked="" type="checkbox"/>	<input checked="" type="checkbox"/>		<input checked="" type="checkbox"/>	<input checked="" type="checkbox"/>				<input checked="" type="checkbox"/>	
CP635	<input checked="" type="checkbox"/>	<input checked="" type="checkbox"/>	<input checked="" type="checkbox"/>	<input type="checkbox"/>	<input checked="" type="checkbox"/>	<input checked="" type="checkbox"/>		<input checked="" type="checkbox"/>	<input checked="" type="checkbox"/>				<input checked="" type="checkbox"/>	
CP635-WEB	<input checked="" type="checkbox"/>	<input checked="" type="checkbox"/>	<input checked="" type="checkbox"/>	<input type="checkbox"/>	<input checked="" type="checkbox"/>	<input checked="" type="checkbox"/>		<input checked="" type="checkbox"/>	<input checked="" type="checkbox"/>				<input checked="" type="checkbox"/>	
CP650	<input checked="" type="checkbox"/>	<input checked="" type="checkbox"/>	<input checked="" type="checkbox"/>	<input type="checkbox"/>	<input checked="" type="checkbox"/>	<input checked="" type="checkbox"/>		<input checked="" type="checkbox"/>	<input checked="" type="checkbox"/>				<input checked="" type="checkbox"/>	
CP650-WEB	<input checked="" type="checkbox"/>	<input checked="" type="checkbox"/>	<input checked="" type="checkbox"/>	<input type="checkbox"/>	<input checked="" type="checkbox"/>	<input checked="" type="checkbox"/>		<input checked="" type="checkbox"/>	<input checked="" type="checkbox"/>				<input checked="" type="checkbox"/>	
CP651	<input checked="" type="checkbox"/>	<input checked="" type="checkbox"/>	<input checked="" type="checkbox"/>	<input type="checkbox"/>	<input checked="" type="checkbox"/>	<input type="checkbox"/>		<input checked="" type="checkbox"/>	<input checked="" type="checkbox"/>				<input checked="" type="checkbox"/>	
CP651-WEB	<input checked="" type="checkbox"/>	<input checked="" type="checkbox"/>	<input checked="" type="checkbox"/>	<input type="checkbox"/>	<input checked="" type="checkbox"/>	<input type="checkbox"/>		<input checked="" type="checkbox"/>	<input checked="" type="checkbox"/>				<input checked="" type="checkbox"/>	
CP660	<input checked="" type="checkbox"/>	<input checked="" type="checkbox"/>	<input checked="" type="checkbox"/>	<input type="checkbox"/>	<input checked="" type="checkbox"/>	<input checked="" type="checkbox"/>		<input checked="" type="checkbox"/>	<input checked="" type="checkbox"/>				<input checked="" type="checkbox"/>	
CP660-WEB	<input checked="" type="checkbox"/>	<input checked="" type="checkbox"/>	<input checked="" type="checkbox"/>	<input type="checkbox"/>	<input checked="" type="checkbox"/>	<input checked="" type="checkbox"/>		<input checked="" type="checkbox"/>	<input checked="" type="checkbox"/>				<input checked="" type="checkbox"/>	
CP661	<input checked="" type="checkbox"/>	<input checked="" type="checkbox"/>	<input checked="" type="checkbox"/>	<input type="checkbox"/>	<input checked="" type="checkbox"/>	<input type="checkbox"/>		<input checked="" type="checkbox"/>	<input checked="" type="checkbox"/>				<input checked="" type="checkbox"/>	
CP661-WEB	<input checked="" type="checkbox"/>	<input checked="" type="checkbox"/>	<input checked="" type="checkbox"/>	<input type="checkbox"/>	<input checked="" type="checkbox"/>	<input type="checkbox"/>		<input checked="" type="checkbox"/>	<input checked="" type="checkbox"/>				<input checked="" type="checkbox"/>	
CP665	<input checked="" type="checkbox"/>	<input checked="" type="checkbox"/>	<input checked="" type="checkbox"/>	<input type="checkbox"/>	<input checked="" type="checkbox"/>	<input type="checkbox"/>		<input checked="" type="checkbox"/>	<input checked="" type="checkbox"/>				<input checked="" type="checkbox"/>	
CP665-WEB	<input checked="" type="checkbox"/>	<input checked="" type="checkbox"/>	<input checked="" type="checkbox"/>	<input type="checkbox"/>	<input checked="" type="checkbox"/>	<input type="checkbox"/>		<input checked="" type="checkbox"/>	<input checked="" type="checkbox"/>				<input checked="" type="checkbox"/>	
CP675	<input checked="" type="checkbox"/>	<input checked="" type="checkbox"/>	<input checked="" type="checkbox"/>	<input type="checkbox"/>	<input checked="" type="checkbox"/>	<input checked="" type="checkbox"/>		<input checked="" type="checkbox"/>	<input checked="" type="checkbox"/>				<input checked="" type="checkbox"/>	
CP675-WEB	<input checked="" type="checkbox"/>	<input checked="" type="checkbox"/>	<input checked="" type="checkbox"/>	<input type="checkbox"/>	<input checked="" type="checkbox"/>	<input checked="" type="checkbox"/>		<input checked="" type="checkbox"/>	<input checked="" type="checkbox"/>				<input checked="" type="checkbox"/>	
CP676	<input checked="" type="checkbox"/>	<input checked="" type="checkbox"/>	<input checked="" type="checkbox"/>	<input type="checkbox"/>	<input checked="" type="checkbox"/>	<input type="checkbox"/>		<input checked="" type="checkbox"/>	<input checked="" type="checkbox"/>				<input checked="" type="checkbox"/>	
CP676-WEB	<input checked="" type="checkbox"/>	<input checked="" type="checkbox"/>	<input checked="" type="checkbox"/>	<input type="checkbox"/>	<input checked="" type="checkbox"/>	<input type="checkbox"/>		<input checked="" type="checkbox"/>	<input checked="" type="checkbox"/>				<input checked="" type="checkbox"/>	
DA501	<input checked="" type="checkbox"/>	<input checked="" type="checkbox"/>	<input checked="" type="checkbox"/>	<input type="checkbox"/>	<input checked="" type="checkbox"/>	<input checked="" type="checkbox"/>	<input checked="" type="checkbox"/>	<input checked="" type="checkbox"/>	<input checked="" type="checkbox"/>	<input checked="" type="checkbox"/>	<input checked="" type="checkbox"/>	<input checked="" type="checkbox"/>	<input checked="" type="checkbox"/>	
DA501-XC	<input checked="" type="checkbox"/>	<input checked="" type="checkbox"/>	<input checked="" type="checkbox"/>	<input type="checkbox"/>	<input checked="" type="checkbox"/>	<input checked="" type="checkbox"/>	<input checked="" type="checkbox"/>	<input checked="" type="checkbox"/>	<input checked="" type="checkbox"/>	<input checked="" type="checkbox"/>	<input checked="" type="checkbox"/>	<input checked="" type="checkbox"/>	<input checked="" type="checkbox"/>	
DC522	<input checked="" type="checkbox"/>	<input checked="" type="checkbox"/>	<input checked="" type="checkbox"/>	<input type="checkbox"/>	<input checked="" type="checkbox"/>	<input checked="" type="checkbox"/>	<input checked="" type="checkbox"/>	<input checked="" type="checkbox"/>	<input checked="" type="checkbox"/>	<input checked="" type="checkbox"/>	<input checked="" type="checkbox"/>	<input checked="" type="checkbox"/>	<input checked="" type="checkbox"/>	
DC522-XC	<input checked="" type="checkbox"/>	<input checked="" type="checkbox"/>	<input checked="" type="checkbox"/>	<input type="checkbox"/>	<input checked="" type="checkbox"/>	<input checked="" type="checkbox"/>	<input checked="" type="checkbox"/>	<input checked="" type="checkbox"/>	<input checked="" type="checkbox"/>	<input checked="" type="checkbox"/>	<input checked="" type="checkbox"/>	<input checked="" type="checkbox"/>	<input checked="" type="checkbox"/>	
DC523	<input checked="" type="checkbox"/>	<input checked="" type="checkbox"/>	<input checked="" type="checkbox"/>	<input type="checkbox"/>	<input checked="" type="checkbox"/>	<input checked="" type="checkbox"/>	<input checked="" type="checkbox"/>	<input checked="" type="checkbox"/>	<input checked="" type="checkbox"/>	<input checked="" type="checkbox"/>	<input checked="" type="checkbox"/>	<input checked="" type="checkbox"/>	<input checked="" type="checkbox"/>	
DC523-XC	<input checked="" type="checkbox"/>	<input checked="" type="checkbox"/>	<input checked="" type="checkbox"/>	<input type="checkbox"/>	<input checked="" type="checkbox"/>	<input checked="" type="checkbox"/>	<input checked="" type="checkbox"/>	<input checked="" type="checkbox"/>	<input checked="" type="checkbox"/>	<input checked="" type="checkbox"/>	<input checked="" type="checkbox"/>	<input checked="" type="checkbox"/>	<input checked="" type="checkbox"/>	
DC532	<input checked="" type="checkbox"/>	<input checked="" type="checkbox"/>	<input checked="" type="checkbox"/>	<input type="checkbox"/>	<input checked="" type="checkbox"/>	<input checked="" type="checkbox"/>	<input checked="" type="checkbox"/>	<input checked="" type="checkbox"/>	<input checked="" type="checkbox"/>	<input checked="" type="checkbox"/>	<input checked="" type="checkbox"/>	<input checked="" type="checkbox"/>	<input checked="" type="checkbox"/>	
DC532-XC	<input checked="" type="checkbox"/>	<input checked="" type="checkbox"/>	<input checked="" type="checkbox"/>	<input type="checkbox"/>	<input checked="" type="checkbox"/>	<input checked="" type="checkbox"/>	<input checked="" type="checkbox"/>	<input checked="" type="checkbox"/>	<input checked="" type="checkbox"/>	<input checked="" type="checkbox"/>	<input checked="" type="checkbox"/>	<input checked="" type="checkbox"/>	<input checked="" type="checkbox"/>	
DC541-CM	<input checked="" type="checkbox"/>	<input checked="" type="checkbox"/>	<input checked="" type="checkbox"/>	<input type="checkbox"/>	<input checked="" type="checkbox"/>	<input checked="" type="checkbox"/>	<input checked="" type="checkbox"/>	<input checked="" type="checkbox"/>	<input checked="" type="checkbox"/>	<input checked="" type="checkbox"/>	<input checked="" type="checkbox"/>	<input checked="" type="checkbox"/>	<input checked="" type="checkbox"/>	
DC541-CM-XC	<input checked="" type="checkbox"/>	<input checked="" type="checkbox"/>	<input checked="" type="checkbox"/>	<input type="checkbox"/>	<input checked="" type="checkbox"/>	<input checked="" type="checkbox"/>	<input checked="" type="checkbox"/>	<input checked="" type="checkbox"/>	<input checked="" type="checkbox"/>	<input checked="" type="checkbox"/>	<input checked="" type="checkbox"/>	<input checked="" type="checkbox"/>	<input checked="" type="checkbox"/>	
DC551-CS31	<input checked="" type="checkbox"/>	<input checked="" type="checkbox"/>	<input checked="" type="checkbox"/>	<input type="checkbox"/>	<input checked="" type="checkbox"/>	<input checked="" type="checkbox"/>	<input checked="" type="checkbox"/>	<input checked="" type="checkbox"/>	<input checked="" type="checkbox"/>	<input checked="" type="checkbox"/>	<input checked="" type="checkbox"/>	<input checked="" type="checkbox"/>	<input checked="" type="checkbox"/>	
DC551-CS31-XC	<input checked="" type="checkbox"/>	<input checked="" type="checkbox"/>	<input checked="" type="checkbox"/>	<input type="checkbox"/>	<input checked="" type="checkbox"/>	<input checked="" type="checkbox"/>	<input checked="" type="checkbox"/>	<input checked="" type="checkbox"/>	<input checked="" type="checkbox"/>	<input checked="" type="checkbox"/>	<input checked="" type="checkbox"/>	<input checked="" type="checkbox"/>	<input checked="" type="checkbox"/>	
DC561	<input checked="" type="checkbox"/>	<input checked="" type="checkbox"/>	<input checked="" type="checkbox"/>	<input type="checkbox"/>	<input checked="" type="checkbox"/>	<input checked="" type="checkbox"/>	<input checked="" type="checkbox"/>	<input checked="" type="checkbox"/>	<input checked="" type="checkbox"/>	<input checked="" type="checkbox"/>	<input checked="" type="checkbox"/>	<input checked="" type="checkbox"/>	<input checked="" type="checkbox"/>	
DC562	<input checked="" type="checkbox"/>	<input checked="" type="checkbox"/>	<input checked="" type="checkbox"/>	<input type="checkbox"/>	<input checked="" type="checkbox"/>	<input type="checkbox"/>	<input type="checkbox"/>	<input type="checkbox"/>	<input type="checkbox"/>	<input type="checkbox"/>	<input type="checkbox"/>	<input type="checkbox"/>	<input checked="" type="checkbox"/>	
DI524	<input checked="" type="checkbox"/>	<input checked="" type="checkbox"/>	<input checked="" type="checkbox"/>	<input type="checkbox"/>	<input checked="" type="checkbox"/>	<input checked="" type="checkbox"/>	<input checked="" type="checkbox"/>	<input checked="" type="checkbox"/>	<input checked="" type="checkbox"/>	<input checked="" type="checkbox"/>	<input checked="" type="checkbox"/>	<input checked="" type="checkbox"/>	<input checked="" type="checkbox"/>	
DI524-XC	<input checked="" type="checkbox"/>	<input checked="" type="checkbox"/>	<input checked="" type="checkbox"/>	<input type="checkbox"/>	<input checked="" type="checkbox"/>	<input checked="" type="checkbox"/>	<input checked="" type="checkbox"/>	<input checked="" type="checkbox"/>	<input checked="" type="checkbox"/>	<input checked="" type="checkbox"/>	<input checked="" type="checkbox"/>	<input checked="" type="checkbox"/>	<input checked="" type="checkbox"/>	
DI561	<input checked="" type="checkbox"/>	<input checked="" type="checkbox"/>	<input checked="" type="checkbox"/>	<input type="checkbox"/>	<input checked="" type="checkbox"/>	<input checked="" type="checkbox"/>	<input checked="" type="checkbox"/>	<input checked="" type="checkbox"/>	<input checked="" type="checkbox"/>	<input checked="" type="checkbox"/>	<input checked="" type="checkbox"/>	<input checked="" type="checkbox"/>	<input checked="" type="checkbox"/>	
DI562	<input checked="" type="checkbox"/>	<input checked="" type="checkbox"/>	<input checked="" type="checkbox"/>	<input type="checkbox"/>	<input checked="" type="checkbox"/>	<input checked="" type="checkbox"/>	<input checked="" type="checkbox"/>	<input checked="" type="checkbox"/>	<input checked="" type="checkbox"/>	<input checked="" type="checkbox"/>	<input checked="" type="checkbox"/>	<input checked="" type="checkbox"/>	<input checked="" type="checkbox"/>	
DI571	<input checked="" type="checkbox"/>	<input checked="" type="checkbox"/>	<input checked="" type="checkbox"/>	<input type="checkbox"/>	<input checked="" type="checkbox"/>	<input checked="" type="checkbox"/>	<input checked="" type="checkbox"/>	<input checked="" type="checkbox"/>	<input checked="" type="checkbox"/>	<input checked="" type="checkbox"/>	<input checked="" type="checkbox"/>	<input checked="" type="checkbox"/>	<input checked="" type="checkbox"/>	
DI572	<input type="checkbox"/>	<input type="checkbox"/>	<input type="checkbox"/>	<input type="checkbox"/>	<input type="checkbox"/>	<input type="checkbox"/>	<input type="checkbox"/>	<input type="checkbox"/>	<input type="checkbox"/>	<input type="checkbox"/>	<input type="checkbox"/>	<input type="checkbox"/>	<input type="checkbox"/>	
DI581-S	<input checked="" type="checkbox"/>	<input checked="" type="checkbox"/>	<input checked="" type="checkbox"/>	<input type="checkbox"/>	<input checked="" type="checkbox"/>	<input checked="" type="checkbox"/>	<input checked="" type="checkbox"/>	<input checked="" type="checkbox"/>	<input checked="" type="checkbox"/>	<input checked="" type="checkbox"/>	<input checked="" type="checkbox"/>	<input checked="" type="checkbox"/>	<input checked="" type="checkbox"/>	
DI581-S-XC	<input checked="" type="checkbox"/>	<input checked="" type="checkbox"/>	<input checked="" type="checkbox"/>	<input type="checkbox"/>	<input checked="" type="checkbox"/>	<input checked="" type="checkbox"/>	<input checked="" type="checkbox"/>	<input checked="" type="checkbox"/>	<input checked="" type="checkbox"/>	<input checked="" type="checkbox"/>	<input checked="" type="checkbox"/>	<input checked="" type="checkbox"/>	<input checked="" type="checkbox"/>	
DO524	<input checked="" type="checkbox"/>	<input checked="" type="checkbox"/>	<input checked="" type="checkbox"/>	<input type="checkbox"/>	<input checked="" type="checkbox"/>	<input type="checkbox"/>	<input type="checkbox"/>	<input type="checkbox"/>	<input type="checkbox"/>	<input type="checkbox"/>	<input type="checkbox"/>	<input type="checkbox"/>	<input checked="" type="checkbox"/>	
DO524-XC	<input checked="" type="checkbox"/>	<input checked="" type="checkbox"/>	<input checked="" type="checkbox"/>	<input type="checkbox"/>	<input checked="" type="checkbox"/>	<input type="checkbox"/>	<input type="checkbox"/>	<input type="checkbox"/>	<input type="checkbox"/>	<input type="checkbox"/>	<input type="checkbox"/>	<input type="checkbox"/>	<input checked="" type="checkbox"/>	
DO561	<input checked="" type="checkbox"/>	<input checked="" type="checkbox"/>	<input checked="" type="checkbox"/>	<input type="checkbox"/>	<input checked="" type="checkbox"/>	<input checked="" type="checkbox"/>	<input checked="" type="checkbox"/>	<input checked="" type="checkbox"/>	<input checked="" type="checkbox"/>	<input checked="" type="checkbox"/>	<input checked="" type="checkbox"/>	<input checked="" type="checkbox"/>	<input checked="" type="checkbox"/>	
DO562	<input checked="" type="checkbox"/>	<input checked="" type="checkbox"/>	<input checked="" type="checkbox"/>	<input type="checkbox"/>	<input checked="" type="checkbox"/>	<input type="checkbox"/>	<input type="checkbox"/>	<input type="checkbox"/>	<input type="checkbox"/>	<input type="checkbox"/>	<input type="checkbox"/>	<input type="checkbox"/>	<input checked="" type="checkbox"/>	
DO571	<input checked="" type="checkbox"/>	<input checked="" type="checkbox"/>	<input checked="" type="checkbox"/>	<input type="checkbox"/>	<input checked="" type="checkbox"/>	<input checked="" type="checkbox"/>	<input checked="" type="checkbox"/>	<input checked="" type="checkbox"/>	<input checked="" type="checkbox"/>	<input checked="" type="checkbox"/>	<input checked="" type="checkbox"/>	<input checked="" type="checkbox"/>	<input checked="" type="checkbox"/>	
DO572	<input checked="" type="checkbox"/>	<input checked="" type="checkbox"/>	<input checked="" type="checkbox"/>	<input type="checkbox"/>	<input checked="" type="checkbox"/>	<input checked="" type="checkbox"/>	<input checked="" type="checkbox"/>	<input checked="" type="checkbox"/>	<input checked="" type="checkbox"/>	<input checked="" type="checkbox"/>	<input checked="" type="checkbox"/>	<input checked="" type="checkbox"/>	<input checked="" type="checkbox"/>	
DO573	<input checked="" type="checkbox"/>	<input checked="" type="checkbox"/>	<input checked="" type="checkbox"/>	<input type="checkbox"/>	<input checked="" type="checkbox"/>	<input type="checkbox"/>	<input type="checkbox"/>	<input type="checkbox"/>	<input type="checkbox"/>	<input type="checkbox"/>	<input type="checkbox"/>	<input type="checkbox"/>	<input checked="" type="checkbox"/>	
DX522	<input checked="" type="checkbox"/>	<input checked="" type="checkbox"/>	<input checked="" type="checkbox"/>	<input type="checkbox"/>	<input checked="" type="checkbox"/>	<input checked="" type="checkbox"/>	<input checked="" type="checkbox"/>	<input checked="" type="checkbox"/>	<input checked="" type="checkbox"/>	<input checked="" type="checkbox"/>	<input checked="" type="checkbox"/>	<input checked="" type="checkbox"/>	<input checked="" type="checkbox"/>	
DX522-XC	<input checked="" type="checkbox"/>	<input checked="" type="checkbox"/>	<input checked="" type="checkbox"/>	<input type="checkbox"/>	<input checked="" type="checkbox"/>	<input checked="" type="checkbox"/>	<input checked="" type="checkbox"/>	<input checked="" type="checkbox"/>	<input checked="" type="checkbox"/>	<input checked="" type="checkbox"/>	<input checked="" type="checkbox"/>	<input checked="" type="checkbox"/>	<input checked="" type="checkbox"/>	
DX531	<input checked="" type="checkbox"/>	<input checked="" type="checkbox"/>	<input checked="" type="checkbox"/>	<input type="checkbox"/>	<input checked="" type="checkbox"/>	<input checked="" type="checkbox"/>	<input checked="" type="checkbox"/>	<input checked="" type="checkbox"/>	<input checked="" type="checkbox"/>	<input checked="" type="checkbox"/>	<input checked="" type="checkbox"/>	<input checked="" type="checkbox"/>	<input checked="" type="checkbox"/>	
DX561	<input checked="" type="checkbox"/>	<input checked="" type="checkbox"/>	<input checked="" type="checkbox"/>	<input type="checkbox"/>	<input checked="" type="checkbox"/>	<input checked="" type="checkbox"/>	<input checked="" type="checkbox"/>	<input checked="" type="checkbox"/>	<input checked="" type="checkbox"/>	<input checked="" type="checkbox"/>	<input checked="" type="checkbox"/>	<input checked="" type="checkbox"/>	<input checked="" type="checkbox"/>	
DX571	<input checked="" type="checkbox"/>	<input checked="" type="checkbox"/>	<input checked="" type="checkbox"/>	<input type="checkbox"/>	<input checked="" type="checkbox"/>	<input checked="" type="checkbox"/>	<input checked="" type="checkbox"/>	<input checked="" type="checkbox"/>	<input checked="" type="checkbox"/>	<input checked="" type="checkbox"/>	<input checked="" type="checkbox"/>	<input checked="" type="checkbox"/>	<input checked="" type="checkbox"/>	
DX581-S	<input checked="" type="checkbox"/>	<input checked="" type="checkbox"/>	<input checked="" type="checkbox"/>	<input type="checkbox"/>	<input checked="" type="checkbox"/>	<input checked="" type="checkbox"/>	<input checked="" type="checkbox"/>	<input checked="" type="checkbox"/>	<input checked="" type="checkbox"/>	<input checked="" type="checkbox"/>	<input checked="" type="checkbox"/>	<input checked="" type="checkbox"/>	<input checked="" type="checkbox"/>	
DX581-S-XC	<input checked="" type="checkbox"/>	<input checked="" type="checkbox"/>	<input checked="" type="checkbox"/>	<input type="checkbox"/>	<input checked="" type="checkbox"/>	<input checked="" type="checkbox"/>	<input checked="" type="checkbox"/>	<input checked="" type="checkbox"/>	<input checked="" type="checkbox"/>	<input checked="" type="checkbox"/>	<input checked="" type="checkbox"/>	<input checked="" type="checkbox"/>	<input checked="" type="checkbox"/>	

Additional information

Approvals and certifications

Symbols and legends:

■ Standard product certified: product sticker wears approval mark when mandatory
 □ Approval submitted (roadmap available upon request)

◇ Submission planned (roadmap available upon request)
 N.A. Not applicable N.N. Not needed

Symbol	Approvals						Shipping classification companies							Others
Abbreviation	CE	cUL	TR	C-Tick	KCC	ABS	BV	DNV	GL	LR	RINA	RMRS	ROHS	
Name		Ordinary Locations	Hazardous Locations Class I Div 2	TR CU 004/2011 Formerly known as CQSR										
FM562	■	■	■	□	■	□	◇	◇	◇	◇	◇	◇	◇	■
MC502	N.A.	■	■	□	N.A.	N.A.	■	■	■	■	■	■	■	■
MC503	■	■	■	□	■	■	■	■	■	■	■	■	■	■
PM554-RP	■	■	■	□	■	□	■	■	■	■	■	■	■	■
PM554-RP-AC	■	■	■	□	■	□	■	■	■	■	■	■	■	■
PM554-TP	■	■	■	□	■	□	■	■	■	■	■	■	■	■
PM554-TP-ETH	■	■	■	□	■	□	■	■	■	■	■	■	■	■
PM556-TP-ETH	■	■	■	□	■	□	■	■	■	■	■	■	■	■
PM564-RP	■	■	■	□	■	□	■	■	■	■	■	■	■	■
PM564-RP-AC	■	■	■	□	■	□	■	■	■	■	■	■	■	■
PM564-RP-ETH	■	■	■	□	■	□	■	■	■	■	■	■	■	■
PM564-RP-ETH-AC	■	■	■	□	■	□	■	■	■	■	■	■	■	■
PM564-TP	■	■	■	□	■	□	■	■	■	■	■	■	■	■
PM564-TP-ETH	■	■	■	□	■	□	■	■	■	■	■	■	■	■
PM572	■	■	■	□	■	■	■	■	■	■	■	■	■	■
PM573-ETH	■	■	■	□	■	■	■	■	■	■	■	■	■	■
PM573-ETH-XC	■	■	■	□	■	■	■	■	■	■	■	■	■	■
PM582	■	■	■	□	■	■	■	■	■	■	■	■	■	■
PM582-XC	■	■	■	□	■	■	■	■	■	■	■	■	■	■
PM583-ETH	■	■	■	□	■	■	■	■	■	■	■	■	■	■
PM583-ETH-XC	■	■	■	□	■	■	■	■	■	■	■	■	■	■
PM590-ETH	■	■	■	□	■	■	■	■	■	■	■	■	■	■
PM591-2ETH	■	■	◇	□	■	◇	◇	◇	◇	◇	◇	◇	◇	■
PM591-ETH	■	■	■	□	■	■	■	■	■	■	■	■	■	■
PM591-ETH-XC	■	■	■	□	■	■	■	■	■	■	■	■	■	■
PM592-ETH	■	■	■	□	■	■	■	■	■	■	■	■	■	■
PM592-ETH-XC	■	■	■	□	■	■	■	■	■	■	■	■	■	■
PM595-4ETH-F	■	■	□	□	■	◇	◇	◇	◇	◇	◇	◇	◇	■
PM595-4ETH-M-XC	■	■	□	□	■	◇	◇	◇	◇	◇	◇	◇	◇	■
SM560-S	■	■	■	□	■	■	■	■	■	■	■	■	■	■
SM560-S-XC	■	■	■	□	■	■	■	■	■	■	■	■	■	■
TA521	N.A.	■	■	□	N.A.	N.A.	■	N.A.	N.A.	N.A.	N.A.	N.A.	■	■
TA523	N.A.	■	■	□	N.A.	N.A.	■	N.A.	N.A.	N.A.	N.A.	N.A.	■	■
TA524	N.A.	■	■	□	N.A.	N.A.	■	N.A.	N.A.	■	N.A.	N.A.	■	N.A.
TA525	N.A.	■	■	□	N.A.	N.A.	■	N.A.	N.A.	N.A.	N.A.	N.A.	■	N.A.
TA526	N.A.	■	■	□	N.A.	N.A.	■	N.A.	N.A.	N.A.	N.A.	N.A.	■	N.A.
TA527	N.A.	N.A.	N.A.	□	N.A.	N.A.	N.A.	N.A.	N.A.	N.A.	N.A.	N.A.	N.A.	N.A.
TA528	N.A.	N.A.	N.A.	□	N.A.	N.A.	N.A.	N.A.	N.A.	N.A.	N.A.	N.A.	N.A.	N.A.
TA540	N.A.	N.A.	N.A.	□	N.A.	N.A.	N.A.	N.A.	N.A.	N.A.	N.A.	N.A.	N.A.	N.A.
TA541	N.A.	N.A.	N.A.	□	N.A.	N.A.	N.A.	N.A.	N.A.	N.A.	N.A.	N.A.	N.A.	N.A.
TA543	N.A.	N.A.	N.A.	□	N.A.	N.A.	N.A.	N.A.	N.A.	N.A.	N.A.	N.A.	N.A.	N.A.
TA561-RTC	■	■	■	□	■	■	■	■	■	■	■	■	■	■
TA562-RS	■	■	■	□	■	■	■	■	■	■	■	■	■	■
TA562-RS-RTC	■	■	■	□	■	■	■	■	■	■	■	■	■	■
TA563-11	N.N.	N.A.	N.A.	□	N.A.	N.A.	■	■	■	■	■	■	■	■
TA563-9	N.N.	N.A.	N.A.	□	N.A.	N.A.	■	■	■	■	■	■	■	■
TA564-11	N.N.	N.A.	N.A.	□	N.A.	N.A.	■	■	■	■	■	■	■	■
TA564-9	N.N.	N.A.	N.A.	□	N.A.	N.A.	■	■	■	■	■	■	■	■
TA565-11	N.N.	N.A.	N.A.	□	N.A.	N.A.	■	■	■	■	■	■	■	■
TA565-9	N.N.	N.A.	N.A.	□	N.A.	N.A.	■	■	■	■	■	■	■	■
TA566	N.N.	N.A.	N.A.	□	N.A.	N.A.	■	■	■	■	■	■	■	N.A.
TA570	N.N.	N.A.	N.A.	□	N.A.	N.A.	N.A.	N.A.	N.A.	N.A.	N.A.	N.A.	N.A.	N.A.
TA571-SIM	■	N.N.	N.N.	□	N.N.	■	N.N.	N.N.	N.N.	N.N.	N.N.	N.N.	N.N.	■
TB511-ETH	■	■	■	□	■	■	■	■	■	■	■	■	■	■
TB511-ETH-XC	■	■	■	□	■	■	■	■	■	■	■	■	■	■
TB521-ETH	■	■	■	□	■	■	■	■	■	■	■	■	■	■

Additional information

Approvals and certifications

Symbols and legends:

■ Standard product certified: product sticker wears approval mark when mandatory
 □ Approval submitted (roadmap available upon request)

◇ Submission planned (roadmap available upon request)
 N.A. Not applicable N.N. Not needed

Symbol	Approvals					Shipping classification companies								Others
	CE	cUL LISTED		TR	C-Tick	KCC	ABS	BV	DNV	GL	LR	RINA	RMRS	ROHS
Abbreviation	CE	Ordinary Locations	Hazardous Locations Class I Div 2	TR CU 004/2011 Formerly known as GOSTR	C-Tick	KCC	ABS	BV	DNV	GL	LR	RINA	RMRS	ROHS
Name														
TB521-ETH-XC	■	■	■	□	■	■	■	■	■	■	■	■	■	■
TB523-2ETH	■	■	◇	□	■	◇	◇	◇	◇	◇	◇	◇	◇	■
TB541-ETH	■	■	■	□	■	■	■	■	■	■	■	■	■	■
TB541-ETH-XC	■	■	■	□	■	■	■	■	■	■	■	■	■	■
TK501	N.A.	■	■	□	N.A.	N.A.	■	N.A.	N.A.	N.A.	N.A.	■	■	■
TK502	N.A.	■	■	□	N.A.	N.A.	■	N.A.	N.A.	N.A.	N.A.	■	■	■
TK503	■	■	■	□	■	■	■	■	■	■	■	■	■	■
TK504	■	■	■	□	■	■	■	■	■	■	■	■	■	■
TK506	■	■	■	□	■	■	■	■	■	■	■	■	■	■
TU507-ETH	■	■	■	□	■	■	■	■	■	■	■	■	■	■
TU508-ETH	■	■	■	□	■	■	■	■	■	■	■	■	■	■
TU508-ETH-XC	■	■	■	□	■	■	■	■	■	■	■	■	■	■
TU509	■	■	■	□	■	■	■	■	■	■	■	■	■	■
TU510	■	■	■	□	■	■	■	■	■	■	■	■	■	■
TU510-XC	■	■	■	□	■	■	■	■	■	■	■	■	■	■
TU515	■	■	■	□	■	■	■	■	■	■	■	■	■	■
TU516	■	■	■	□	■	■	■	■	■	■	■	■	■	■
TU516-XC	■	■	■	□	■	■	■	■	■	■	■	■	■	■
TU517	■	■	■	□	■	■	■	■	■	■	■	■	■	■
TU518	■	■	■	□	■	■	■	■	■	■	■	■	■	■
TU518-XC	■	■	■	□	■	■	■	■	■	■	■	■	■	■
TU520-ETH	■	■	■	□	■	■	■	■	■	■	■	■	■	■
TU520-ETH-XC	■	■	■	□	■	■	■	■	■	■	■	■	■	■
TU531	■	■	■	□	■	■	■	■	■	■	■	■	■	■
TU532	■	■	■	□	■	■	■	■	■	■	■	■	■	■
TU532-XC	■	■	■	□	■	■	■	■	■	■	■	■	■	■
TU551-CS31	■	■	■	□	■	■	■	■	■	■	■	■	■	■
TU552-CS31	■	■	■	□	■	■	■	■	■	■	■	■	■	■
TU552-CS31-XC	■	■	■	□	■	■	■	■	■	■	■	■	■	■
TU582-S	■	■	■	□	■	■	■	■	■	■	■	■	■	■
TU582-S-XC	■	■	■	□	■	■	■	■	■	■	■	■	■	■

Additional information

PLC Automation website - Online tools

The www.abb.com/plc website is a mine of information on our products and documentation.

1

PLC INFORMATION

Power and productivity for a better world™ **ABB**

PLC Automation

ABB's automation devices deliver solutions with high performance and flexibility to be effectively deployed within diverse industries and applications including water, building infrastructure, data centers, renewable energy, machinery automation, material handling, marine and more.

Are you looking for support or purchase information?
[Contact us](#)

Our offering

- Programmable Logic Controllers PLCs
- Automation Builder
- Control panels
- Supervisory software

Highlights

- Latest product news
- Main catalog
- SPS/PLC Drives
November 25-27, 2014
→ Nuremberg, Germany
- SPS/PLC
Event website in German
- Follow us

Industries and applications

- Cranes
- Food and beverage
- HVAC
- Marine
- Mining
- Plastics and rubber
- Water and wastewater

Services

- Documents and downloads
- Application examples
- Frequently asked questions
- Training locations
- Training courses
- Parts online
- Success stories

Related products

- Drives
- Drives channel network
- Motion control
- Robotics

Contact information

What would you like to do?

[I need more information](#)

ABB logo

2

HOME | OFFERINGS | MEDIA | CAREERS | INVESTORS | ABOUT | CONVERSATIONS

Power and productivity for a better world™ **ABB**

Gesellschaften

Grundsatz
ABB STOTZ-KONTAKT
 ABB Stotz-Kontakt /
 Diebel & John
 Vertriebsgesellschaft
 mbH

FAQ of PLC and automation products

- AC500 CPU
Information of AC500 CPUs
- AC500-eCo
Information of eCo CPU and eCo IO modules
- PSS01
Programming software of AC500
- Special functionalities
Visualisation, FTP, SNMP, SMTP etc.
- Accessories
SD card, battery, cable
- UMC
Universal Motor Controller
- S500 & CM5xx
IO modules and communication couplers
- AC500-S
Information of Safety CPU and Safety IO modules
- OPC based
OPC based communication, e.g. HA, Digits 500
- Motion Control
PLCOpen Motion Control Library MC501
- CP operating panel
CP600, CP400, CP500
- 07KT97/98
Software and hardware of 07KT97/98

→ Tips for using FAQ

Search **OK**

→ Rate this page

→ Share this page

Technical Support PLC
 +49 6221 701 1444
 plc.support@de.abb.com

3

HOME | OFFERINGS | MEDIA | CAREERS | INVESTORS | ABOUT | CONVERSATIONS

Power and productivity for a better world™ **ABB**

Product Guide > PLC Automation > Application examples for Automation Builder/Control Builder Plus for downloading

Application examples for Automation Builder/Control Builder Plus for downloading

Automation Builder is the integrated engineering suite for machine builders and system integrators. Automation Builder includes the PLC programming software Control Builder Plus. It is designed for efficient programming of the AC500 PLC platform and specific Low Voltage Drives offered by ABB.

The application examples contain programming descriptions for different communication protocols and automation components.

Complete overview

Communication Protocols

- ASCII
- DeviceNet
- FTP Client
- Modbus TCP/IP
- PROFIBUS DP
- SNMP
- UDP
- CANopen/CAN 2AB
- EtherCAT
- Modbus RTU
- OPC
- PROFINET
- SMTP

Others

- Circuit Breakers
- Drives
- Java
- PLC programming
- Softstarters
- Control Panels
- HVAC
- KNX
- Robotics
- UMC

Search **OK**

Products & Services only

→ Rate this page

→ Share this page

Your preferences:

Germany **OK**

English **OK**

ABB contact for Germany

→ Vertrieb Antriebe und Motoren

Select another country **OK**

- 1 PLC Automation
- 2 FAQ of PLC and automation products
- 3 Application examples

Additional information

Order and delivery

Automation products

With more than 100 manufacturing sites in 50 countries (see image below), the Automation Products Division of ABB is able to deliver one million products per day through sales activities in more than 200 countries. ABB often gets the reaction from its customers, "Do you really do all that?",

when they take a first glance at ABB's Automation Products catalog. With a range of more than 170,000 products, ABB supplies just about every type of electronic equipment; from standard components to the latest control technology, to meet all customer's need, whether a standalone product or a completely integrated system.

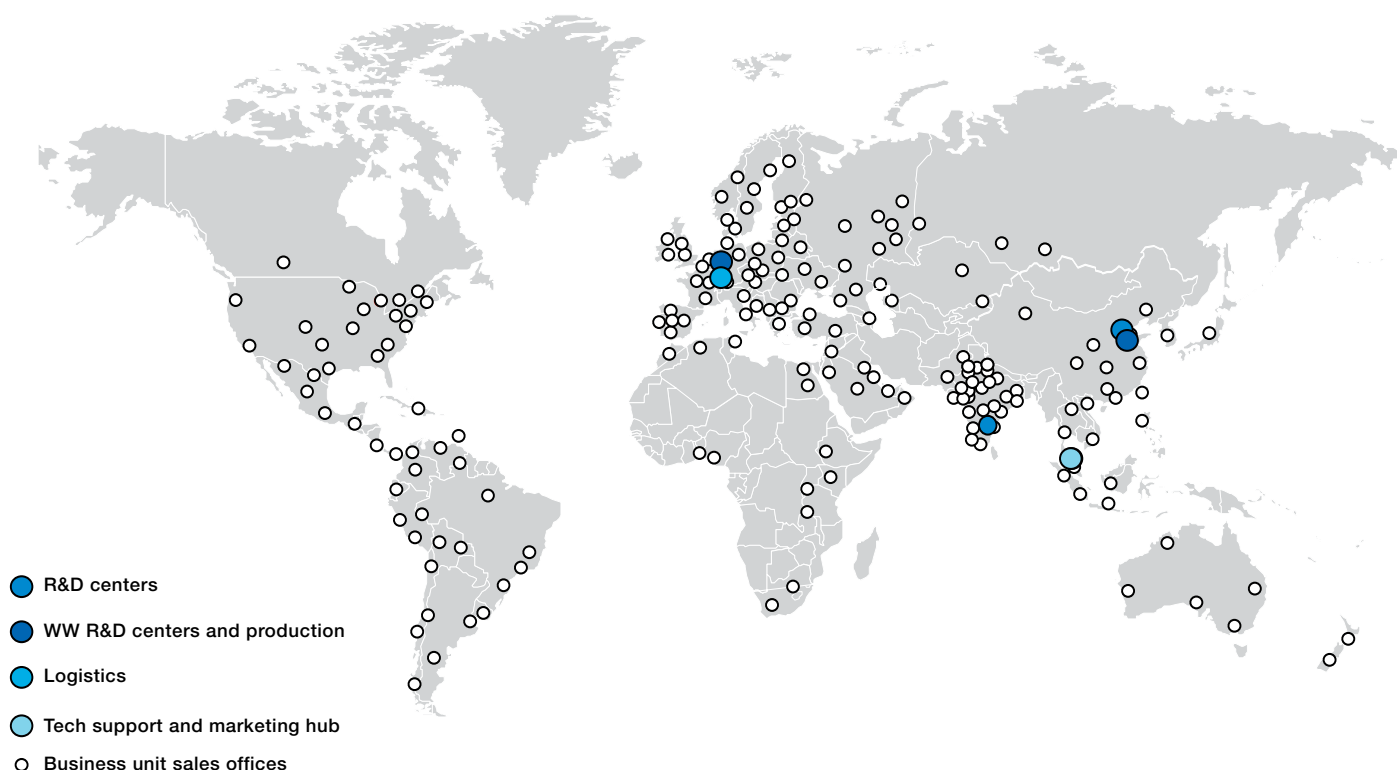

Through its global logistics network, ABB offers genuine factory certified spare parts and related services tailored to customer's needs. A wide range of parts is available within a short time, often in 24 hours direct to site. ABB spare parts and services can be purchased from more than 1400 companies located throughout the world and is able to serve customers locally, often in their own language. These companies include ABB's own offices and authorized channel partners.

In many countries, ABB and its channel partners, stock products and spare parts locally, providing high availability and, often, same day delivery. To minimize its customer's costly downtime, ABB's logistics network, in many countries, operate 24 hours a day, seven days a week, using air freight and express courier services.



Index

Order code classification

Order code	Type	Page	Order code	Type	Page	Order code	Type	Page
1SAJ929400R0001	UTF21-FBP	4/60	1SAP190500R0001	PS541-HMI	2/33	1SAP250600R0001	AI531	4/56
1SAP111100R0270	TB511-ETH	4/55	1SAP192100R0002	PS552-MC-E	2/33	1SAP250700R0001	DA501	4/57
1SAP112100R0270	TB521-ETH	4/55	1SAP192900R0011	CM589-PNIO	4/56	1SAP260300R0001	CD522	4/56
1SAP112300R0277	TB523-2ETH	4/55	1SAP193000R0101	DM-TOOL	2/33	1SAP270000R0001	DC541-CM	4/56
1SAP114100R0270	TB541-ETH	4/55	1SAP193001R0101	DM-TOOL-UPGR	2/33	1SAP280000R0001	SM560-S	6/121
1SAP120600R0001	PM554-TP	3/39	1SAP193004R0101	DM-PREM-UPGR	2/33	1SAP281200R0001	TU582-S	6/121
1SAP120600R0071	PM554-TP-ETH	3/39	1SAP193005R0101	DM-PREM	2/33	1SAP282000R0001	AI581-S	6/121
1SAP120700R0001	PM554-RP	3/39	1SAP193600R0001	DM-KEY	2/33	1SAP284000R0001	DI581-S	6/121
1SAP120800R0001	PM554-RP-AC	3/39	1SAP193700R0001	CM597-ETH	4/56	1SAP284100R0001	DX581-S	6/121
1SAP120900R0001	PM564-TP	3/39	1SAP195000R0001	PS562-SOLAR	2/33	1SAP311100R0270	TB511-ETH-XC	5/89
1SAP120900R0071	PM564-TP-ETH	3/39	1SAP195200R0001	PS563-WATER	2/33	1SAP312100R0270	TB521-ETH-XC	5/89
1SAP121000R0001	PM564-RP	3/39	1SAP195400R0001	PS564-TEMPCTRL	2/33	1SAP314100R0270	TB421-ETH-XC	5/89
1SAP121000R0071	PM564-RP-ETH	3/39	1SAP198000R0001	PS501-S	6/121	1SAP330300R0271	PM573-ETH-XC	5/89
1SAP121100R0001	PM564-RP-AC	3/39	1SAP210400R0001	TU552-CS31	4/59	1SAP340200R0201	PM582-XC	5/89
1SAP121100R0071	PM564-RP-ETH-AC	3/39	1SAP210600R0001	TU551-CS31	4/59	1SAP340300R0271	PM583-ETH-XC	5/89
1SAP121200R0071	PM556-TP-ETH	3/39	1SAP210800R0001	TU510	4/59	1SAP350100R0271	PM591-ETH-XC	5/89
1SAP130200R0200	PM572	4/55	1SAP211000R0001	TU509	4/59	1SAP350200R0271	PM592-ETH-XC	5/89
1SAP130300R0271	PM573-ETH	4/55	1SAP211200R0001	TU518	4/59	1SAP351500R0279	PM595-4ETH-M-XC	5/89
1SAP140200R0201	PM582	4/55	1SAP211400R0001	TU517	4/59	1SAP370200R0001	CM572-DP-XC	5/90
1SAP140300R0271	PM583-ETH	4/55	1SAP212000R0001	TU516	4/59	1SAP370800R0001	CM578-CN-XC	5/90
1SAP150000R0271	PM590-ETH	4/55	1SAP212200R0001	TU515	4/59	1SAP370901R0101	CM579-PNIO-XC	5/90
1SAP150100R0271	PM591-ETH	4/55	1SAP214000R0001	TU508-ETH	4/59	1SAP372800R0001	CM588-CN-XC	5/90
1SAP150100R0277	PM591-2ETH	4/55	1SAP214200R0001	TU507-ETH	4/59	1SAP372900R0011	CM589-PNIO-XC	5/90
1SAP150200R0271	PM592-ETH	4/55	1SAP214400R0001	TU520-ETH	4/59	1SAP373700R0001	CM597-ETH-XC	5/90
1SAP155500R0279	PM595-4ETH-F	4/55	1SAP217000R0001	TU532	4/59	1SAP380000R0001	SM560-S-XC	6/122
1SAP170200R0001	CM572-DP	4/56	1SAP217200R0001	TU531	4/59	1SAP410400R0001	TU552-CS31-XC	5/93
1SAP170400R0201	CM574-RS	4/56	1SAP220500R0001	DC551-CS31	4/58	1SAP410800R0001	TU510-XC	5/93
1SAP170401R0201	CM574-RCOM	4/56	1SAP220600R0001	CI501-PNIO	4/58	1SAP411200R0001	TU518-XC	5/93
1SAP170800R0001	CM578-CN	4/56	1SAP220700R0001	CI502-PNIO	4/58	1SAP412000R0001	TU516-XC	5/93
1SAP170901R0101	CM579-PNIO	4/56	1SAP220900R0001	CI511-ETHCAT	4/58	1SAP414000R0001	TU508-ETH-XC	5/93
1SAP170902R0001	CM579-ETHCAT	4/56	1SAP221000R0001	CI512-ETHCAT	4/58	1SAP414400R0001	TU520-ETH-XC	5/93
1SAP172800R0001	CM588-CN	4/56	1SAP221100R0001	CI590-CS31-HA	4/58	1SAP417000R0001	TU532-XC	5/93
1SAP180100R0001	MC502	3/41	1SAP221200R0001	CI592-CS31	4/58	1SAP420500R0001	DC551-CS31-XC	5/92
1SAP180200R0001	TK501	4/60	1SAP221300R0001	CI504-PNIO	4/58	1SAP420600R0001	CI501-PNIO-XC	5/92
1SAP180200R0101	TK502	4/60	1SAP221500R0001	CI506-PNIO	4/58	1SAP420700R0001	CI502-PNIO-XC	5/92
1SAP180300R0001	TA521	4/60	1SAP2224100R0001	CI541-DP	4/58	1SAP421100R0001	CI590-CS31-HA-XC	5/92
1SAP180500R0001	TA523	4/60	1SAP2224200R0001	CI542-DP	4/58	1SAP421200R0001	CI592-CS31-XC	5/92
1SAP180600R0001	TA524	4/60	1SAP228100R0001	CI581-CN	4/58	1SAP421300R0001	CI504-PNIO-XC	5/92
1SAP180700R0001	TA525	4/60	1SAP228200R0001	CI582-CN	4/58	1SAP421500R0001	CI506-PNIO-XC	5/92
1SAP180800R0001	TA526	4/60	1SAP230500R0000	DI572	3/40	1SAP424100R0001	CI541-DP-XC	5/92
1SAP181100R0001	TA527	4/60	1SAP230900R0000	DO562	3/40	1SAP424200R0001	CI542-DP-XC	5/92
1SAP181200R0001	TA528	4/60	1SAP231300R0000	DO573	3/40	1SAP428100R0001	CI581-CN-XC	5/92
1SAP181400R0001	TA561-RTC	3/41	1SAP231900R0000	DC562	3/40	1SAP428200R0001	CI582-CN-XC	5/92
1SAP181500R0001	TA562-RS-RTC	3/41	1SAP233100R0001	FM562	3/41	1SAP440000R0001	DI524-XC	5/90
1SAP182300R0001	TA535	5/94	1SAP240000R0001	DI524	4/56	1SAP440100R0001	DC532-XC	5/90
1SAP182400R0001	TA512-BAS	4/60	1SAP240100R0001	DC532	4/56	1SAP440500R0001	DC523-XC	5/90
1SAP182500R0001	TA513-ADV	4/60	1SAP240500R0001	DC523	4/56	1SAP440600R0001	DC522-XC	5/90
1SAP182600R0001	TA540	4/60	1SAP240600R0001	DC522	4/56	1SAP440700R0001	DO524-XC	5/90
1SAP182700R0001	TA541	4/60	1SAP240700R0001	DO524	4/56	1SAP445200R0001	DX522-XC	5/90
1SAP182800R0001	TA543	4/60	1SAP245000R0001	DX531	4/56	1SAP450000R0001	AX522-XC	5/90
1SAP186100R0001	TK506	3/41	1SAP245200R0001	DX522	4/56	1SAP450100R0001	AX521-XC	5/90
1SAP186200R0001	TA574-A-R-AC	11/165	1SAP250000R0001	AX522	4/56	1SAP450200R0001	AO523-XC	5/90
1SAP186200R0002	TA574-A-R	11/165	1SAP250100R0001	AX521	4/56	1SAP450300R0001	AI523-XC	5/90
1SAP186200R0003	TA574-A-T	11/165	1SAP250200R0001	AO523	4/56	1SAP450600R0001	AI531-XC	5/90
1SAP186200R0004	TA574-D-T-ETH	11/165	1SAP250300R0001	AI523	4/56	1SAP450700R0001	DA501-XC	5/90

Index

Order code classification

Order code	Type	Page	Order code	Type	Page	Order code	Type	Page
1SAP460300R0001	CD522-XC	5/91	1TNE968901R3102	TA563-11	3/41	FMH2A06TR-RN43W		10/152
1SAP470000R0001	DC541-CM-XC	5/91	1TNE968901R3103	TA564-9	3/41	FMH2A09TR-EN23W		10/152
1SAP481200R0001	TU582-S-XC	6/122	1TNE968901R3104	TA564-11	3/41	FMH2A09TR-EN43W		10/152
1SAP482000R0001	AI581-S-XC	6/122	1TNE968901R3105	TA565-9	3/41	FMH2A09TR-RN23W		10/152
1SAP484000R0001	DI581-S-XC	6/122	1TNE968901R3106	TA565-11	3/41	FMH2A09TR-RN43W		10/152
1SAP484100R0001	DX581-S-XC	6/122	1TNE968901R3107	TA566	3/41	L516		10/153
1SAP500900R0001	PB610	7/133	1TNE968901R3203	TA570	3/41	L517		10/153
1SAP500981R0001	TK681	7/133	1TNE968901R4300	TA562-RS	3/41	L518		10/153
1SAP500982R0001	TK682	7/133	1TNE968902R1101	AI561	3/40	L530		10/153
1SAP501800R0011	DV500-GBUILDER	8/139	1TNE968902R1102	AI562	3/40	MFE180-04AN-016A-4		10/153
1SAP501800R0021	DV500-OP50	8/139	1TNE968902R1103	AI563	3/40	MFE180-04AN-024A-4		10/153
1SAP501800R0031	DV500-OP100	8/139	1TNE968902R1201	AO561	3/40	MFE180-04AN-024A-4		10/153
1SAP501800R0041	DV500-OP250	8/139	1TNE968902R1301	AX561	3/40	MFE180-04AN-03A0-4		10/153
1SAP501800R0051	DV500-OP500	8/139	1TNE968902R2001	DC561	3/40	MFE180-04AN-046A-4		10/153
1SAP501800R0061	DV500-OP1000	8/139	1TNE968902R2101	DI561	3/40	MFE180-04AN-05A0-4		10/153
1SAP501800R0071	DV500-OP2000	8/139	1TNE968902R2102	DI562	3/40	MFE180-04AN-060A-4		10/153
1SAP501800R0081	DV500-OPUNL	8/139	1TNE968902R2103	DI571	3/40	MFE180-04AN-07A0-4		10/153
1SAP501800R0091	DV500-EXP100	8/139	1TNE968902R2201	DO561	3/40	MFE180-04AN-090A-4		10/153
1SAP501800R0101	DV500-EXP250	8/139	1TNE968902R2202	DO571	3/40	MFE230A003BW		10/152
1SAP501800R0111	DV500-EXP500	8/139	1TNE968902R2203	DO572	3/40	MFE230A006BW		10/152
1SAP501800R0121	DV500-EXP1000	8/139	1TNE968902R2301	DX561	3/40	MFE230A009BW		10/152
1SAP501800R0131	DV500-EXP2000	8/139	1TNE968902R2302	DX571	3/40	N8020		10/153
1SAP501800R0141	DV500-EXPUNL	8/139	1TNE968903R0203	TA571-SIM	3/40	NSB202-501W		10/155
1SAP501800R0151	DV500-USB-R	8/139	3AUA0000035503		10/153	NSB202-502W		10/155
1SAP501800R0161	DV500-WEBDIS	8/139	3AUA0000035504		10/153	NSB203-501W		10/155
1SAP501800R0171	DV500-DUALMON	8/139	3AUA0000036067		10/153	NSB203-502W		10/155
1SAP501800R0181	DV500-DIGIB	8/139	3AUA0000036068		10/153	NSB204-501W		10/155
1SAP501800R0191	DV500-SLOCK	8/139	68711401		10/153	NSB204-502W		10/155
1SAP501900R0001	DV500-CD	8/139	68711428		10/153	NSB205-501W		10/155
1SAP520100R0001	CP620	7/133	68711436		10/153	NSB205-502W		10/155
1SAP520200R0001	CP620-WEB	7/133	68711444		10/153	NXE100-1608DBW		10/155
1SAP530100R0001	CP630	7/133	68711185		10/153	NXE100-1608SBW		10/155
1SAP530200R0001	CP630-WEB	7/133	68711193		10/153	NXE100-1612DBW		10/155
1SAP535100R0001	CP635	7/133	68711231		10/153	NXE100-1612SBW		10/155
1SAP535200R0001	CP635-WEB	7/133	68711240		10/153	NXE100-1616DBW		10/155
1SAP551100R0001	CP651	7/133	68711266		10/153	NXE100-1616SBW		10/155
1SAP551200R0001	CP651-WEB	7/133	68711321		10/153	OPT-MF-100		10/153
1SAP561100R0001	CP661	7/133	68711339		10/153	OPT-MF-101		10/153
1SAP561200R0001	CP661-WEB	7/133	68711355		10/153	PCI201-501		10/155
1SAP565100R0001	CP665	7/133	68711371		10/153	PCI201-502		10/155
1SAP565200R0001	CP665-WEB	7/133	68816238		10/153	PCI201-503		10/155
1SAP576100R0001	CP676	7/133	68816246		10/153	PCI201-504		10/155
1SAP576200R0001	CP676-WEB	7/133	E152A03EINA		10/152	PCI201-508		10/155
1SBN260216R1001	TK401	7/133	E152A03EIOA		10/152	PCI201-511		10/155
1SBN260217R1001	TK402	7/133	E152A06EINA		10/152	PCI201-512		10/155
1SBN260221R1001	TK405	7/133	E152A06EIOA		10/152	PCI201-513		10/155
1SBN260224R1001	TK406	7/133	E152A09EINA		10/152	PCI201-514		10/155
1SBN260318R1001	DV500-USB	8/139	E152A09EIOA		10/152	PCI201-518		10/155
1SBP260183R1001	CP430B	7/133	FMH2A03TR-EN23W		10/152			
1SBP260191R1001	CP415M	7/133	FMH2A03TR-EN43W		10/152			
1SBS260284R1001	CP400Soft	7/133	FMH2A03TR-RN23W		10/152			
1TNE968901R0100	MC503	3/41	FMH2A03TR-RN43W		10/152			
1TNE968901R1100	TK503	3/41	FMH2A06TR-EN23W		10/152			
1TNE968901R2100	TK504	3/41	FMH2A06TR-EN43W		10/152			
1TNE968901R3101	TA563-9	3/41	FMH2A06TR-RN23W		10/152			

Index

Type classification

Type	Order code	Page	Type	Order code	Page	Type	Order code	Page
AI523	1SAP250300R0001	4/56	CM597-ETH-XC	1SAP373700R0001	5/90	DV500-EXP100	1SAP501800R0091	8/139
AI523-XC	1SAP450300R0001	5/90	CP400Soft	1SBS260284R1001	7/133	DV500-EXP1000	1SAP501800R0121	8/139
AI531	1SAP250600R0001	4/56	CP415M	1SBP260191R1001	7/133	DV500-EXP2000	1SAP501800R0131	8/139
AI531-XC	1SAP450600R0001	5/90	CP430B	1SBP260183R1001	7/133	DV500-EXP250	1SAP501800R0101	8/139
AI561	1TNE968902R1101	3/40	CP620	1SAP520100R0001	7/133	DV500-EXP500	1SAP501800R0111	8/139
AI562	1TNE968902R1102	3/40	CP620-WEB	1SAP520200R0001	7/133	DV500-EXPUNL	1SAP501800R0141	8/139
AI563	1TNE968902R1103	3/40	CP630	1SAP530100R0001	7/133	DV500-GBUILDER	1SAP501800R0011	8/139
AI581-S	1SAP282000R0001	6/121	CP630-WEB	1SAP530200R0001	7/133	DV500-OP100	1SAP501800R0031	8/139
AI581-S-XC	1SAP482000R0001	6/122	CP635	1SAP535100R0001	7/133	DV500-OP1000	1SAP501800R0061	8/139
AO523	1SAP250200R0001	4/56	CP635-WEB	1SAP535200R0001	7/133	DV500-OP2000	1SAP501800R0071	8/139
AO523-XC	1SAP450200R0001	5/90	CP651	1SAP551100R0001	7/133	DV500-OP250	1SAP501800R0041	8/139
AO561	1TNE968902R1201	3/40	CP651-WEB	1SAP551200R0001	7/133	DV500-OP50	1SAP501800R0021	8/139
AX521	1SAP250100R0001	4/56	CP661	1SAP561100R0001	7/133	DV500-OP500	1SAP501800R0051	8/139
AX521-XC	1SAP450100R0001	5/90	CP661-WEB	1SAP561200R0001	7/133	DV500-OPUNL	1SAP501800R0081	8/139
AX522	1SAP250000R0001	4/56	CP665	1SAP565100R0001	7/133	DV500-SLOCK	1SAP501800R0191	8/139
AX522-XC	1SAP450000R0001	5/90	CP665-WEB	1SAP565200R0001	7/133	DV500-USB	1SBN260318R1001	8/139
AX561	1TNE968902R1301	3/40	CP676	1SAP576100R0001	7/133	DV500-USB-R	1SAP501800R0151	8/139
CD522	1SAP260300R0001	4/57	CP676-WEB	1SAP576200R0001	7/133	DV500-WEBDIS	1SAP501800R0161	8/139
CD522-XC	1SAP460300R0001	5/91	DA501	1SAP250700R0001	4/57	DX522	1SAP245200R0001	4/56
CI501-PNIO	1SAP220600R0001	4/58	DA501-XC	1SAP450700R0001	5/90	DX522-XC	1SAP445200R0001	5/90
CI501-PNIO-XC	1SAP420600R0001	5/92	DC522	1SAP240600R0001	4/56	DX531	1SAP245000R0001	4/56
CI502-PNIO	1SAP220700R0001	4/58	DC522-XC	1SAP440600R0001	5/90	DX561	1TNE968902R2301	3/40
CI502-PNIO-XC	1SAP420700R0001	5/92	DC523	1SAP240500R0001	4/56	DX571	1TNE968902R2302	3/40
CI504-PNIO	1SAP221300R0001	4/58	DC523-XC	1SAP440500R0001	5/90	DX581-S	1SAP284100R0001	6/121
CI504-PNIO-XC	1SAP421300R0001	5/92	DC532	1SAP240100R0001	4/56	DX581-S-XC	1SAP484100R0001	6/122
CI506-PNIO	1SAP221500R0001	4/58	DC532-XC	1SAP440100R0001	5/90	FM562	1SAP233100R0001	3/41
CI506-PNIO-XC	1SAP421500R0001	5/92	DC541-CM	1SAP270000R0001	4/57	MC502	1SAP180100R0001	3/41
CI511-ETHCAT	1SAP220900R0001	4/58	DC541-CM-XC	1SAP470000R0001	5/91	MC503	1TNE968901R0100	3/41
CI512-ETHCAT	1SAP221000R0001	4/58	DC551-CS31	1SAP220500R0001	4/58	PB610	1SAP500900R0001	7/133
CI541-DP	1SAP224100R0001	4/58	DC551-CS31-XC	1SAP420500R0001	5/92	PM554-RP	1SAP120700R0001	3/39
CI541-DP-XC	1SAP424100R0001	5/92	DC561	1TNE968902R2001	3/40	PM554-RP-AC	1SAP120800R0001	3/39
CI542-DP	1SAP224200R0001	4/58	DC562	1SAP231900R0000	3/40	PM554-TP	1SAP120600R0001	3/39
CI542-DP-XC	1SAP424200R0001	5/92	DI524	1SAP240000R0001	4/56	PM554-TP-ETH	1SAP120600R0071	3/39
CI581-CN	1SAP228100R0001	4/58	DI524-XC	1SAP440000R0001	5/90	PM556-TP-ETH	1SAP121200R0071	3/39
CI581-CN-XC	1SAP428100R0001	5/92	DI561	1TNE968902R2101	3/40	PM564-RP	1SAP121000R0001	3/39
CI582-CN	1SAP228200R0001	4/58	DI562	1TNE968902R2102	3/40	PM564-RP-AC	1SAP121100R0001	3/39
CI582-CN-XC	1SAP428200R0001	5/92	DI571	1TNE968902R2103	3/40	PM564-RP-ETH	1SAP121000R0071	3/39
CI590-CS31-HA	1SAP221100R0001	4/58	DI572	1SAP230500R0000	3/40	PM564-RP-ETH-AC	1SAP121100R0071	3/39
CI590-CS31-HA-XC	1SAP421100R0001	5/92	DI581-S	1SAP284000R0001	6/121	PM564-TP	1SAP120900R0001	3/39
CI592-CS31	1SAP221200R0001	4/58	DI581-S-XC	1SAP484000R0001	6/122	PM564-TP-ETH	1SAP120900R0071	3/39
CI592-CS31-XC	1SAP421200R0001	5/92	DM-KEY	1SAP193600R0001	2/33	PM572	1SAP130200R0200	4/55
CM572-DP	1SAP170200R0001	4/56	DM-PREM	1SAP193005R0101	2/33	PM573-ETH	1SAP130300R0271	4/55
CM572-DP-XC	1SAP370200R0001	5/90	DM-PREM-UPGR	1SAP193004R0101	2/33	PM573-ETH-XC	1SAP330300R0271	5/89
CM574-RCOM	1SAP170401R0201	4/56	DM-TOOL	1SAP193000R0101	2/33	PM582	1SAP140200R0201	4/55
CM574-RS	1SAP170400R0201	4/56	DM-TOOL-UPGR	1SAP193001R0101	2/33	PM582-XC	1SAP340200R0201	5/89
CM578-CN	1SAP170800R0001	4/56	DO524	1SAP240700R0001	4/56	PM583-ETH	1SAP140300R0271	4/55
CM578-CN-XC	1SAP370800R0001	5/90	DO524-XC	1SAP440700R0001	5/90	PM583-ETH-XC	1SAP340300R0271	5/89
CM579-ETHCAT	1SAP170902R0001	4/56	DO561	1TNE968902R2201	3/40	PM590-ETH	1SAP150000R0271	4/55
CM579-PNIO	1SAP170901R0101	4/56	DO562	1SAP230900R0000	3/40	PM591-2ETH	1SAP150100R0277	4/55
CM579-PNIO-XC	1SAP370901R0101	5/90	DO571	1TNE968902R2202	3/40	PM591-ETH	1SAP150100R0271	4/55
CM588-CN	1SAP172800R0001	4/56	DO572	1TNE968902R2203	3/40	PM591-ETH-XC	1SAP350100R0271	5/89
CM588-CN-XC	1SAP372800R0001	5/90	DO573	1SAP231300R0000	3/40	PM592-ETH	1SAP150200R0271	4/55
CM589-PNIO	1SAP192900R0011	4/56	DV500-CD	1SAP501900R0001	8/139	PM592-ETH-XC	1SAP350200R0271	5/89
CM589-PNIO-XC	1SAP372900R0011	5/90	DV500-DIGIB	1SAP501800R0181	8/139	PM595-4ETH-F	1SAP155500R0279	4/55
CM597-ETH	1SAP193700R0001	4/56	DV500-DUALMON	1SAP501800R0171	8/139	PM595-4ETH-M-XC	1SAP351500R0279	5/89

Index

Type classification

Type	Order code	Page	Type	Order code	Page
PS501-S	1SAP198000R0001	6/121	TU507-ETH	1SAP214200R0001	4/59
PS541-HMI	1SAP190500R0001	2/33	TU508-ETH	1SAP214000R0001	4/59
PS552-MC-E	1SAP192100R0002	2/33	TU508-ETH-XC	1SAP414000R0001	5/93
PS562-SOLAR	1SAP195000R0001	2/33	TU509	1SAP211000R0001	4/59
PS564-TEMPCTRL	1SAP195400R0001	2/33	TU510	1SAP210800R0001	4/59
PS563-WATER	1SAP195200R0001	2/33	TU510-XC	1SAP410800R0001	5/93
SM560-S	1SAP280000R0001	6/121	TU515	1SAP212200R0001	4/59
SM560-S-XC	1SAP380000R0001	6/122	TU516	1SAP212000R0001	4/59
TA512-BAS	1SAP182400R0001	4/60	TU516-XC	1SAP412000R0001	5/93
TA513-ADV	1SAP182500R0001	4/60	TU517	1SAP211400R0001	4/59
TA521	1SAP180300R0001	4/60	TU518	1SAP211200R0001	4/59
TA523	1SAP180500R0001	4/60	TU518-XC	1SAP411200R0001	5/93
TA524	1SAP180600R0001	4/60	TU520-ETH	1SAP214400R0001	4/59
TA525	1SAP180700R0001	4/60	TU520-ETH-XC	1SAP414400R0001	5/93
TA526	1SAP180800R0001	4/60	TU531	1SAP217200R0001	4/59
TA527	1SAP181100R0001	4/60	TU532	1SAP217000R0001	4/59
TA528	1SAP181200R0001	4/60	TU532-XC	1SAP417000R0001	5/93
TA535	1SAP182300R0001	5/94	TU551-CS31	1SAP210600R0001	4/59
TA540	1SAP182600R0001	4/60	TU552-CS31	1SAP210400R0001	4/59
TA541	1SAP182700R0001	4/60	TU552-CS31-XC	1SAP410400R0001	5/93
TA543	1SAP182800R0001	4/60	TU582-S	1SAP281200R0001	6/121
TA561-RTC	1SAP181400R0001	3/41	TU582-S-XC	1SAP481200R0001	6/122
TA562-RS	1TNE968901R4300	3/41	UTF21-FBP	1SAJ929400R0001	4/60
TA562-RS-RTC	1SAP181500R0001	3/41			
TA563-11	1TNE968901R3102	3/41			
TA563-9	1TNE968901R3101	3/41			
TA564-11	1TNE968901R3104	3/41			
TA564-9	1TNE968901R3103	3/41			
TA565-11	1TNE968901R3106	3/41			
TA565-9	1TNE968901R3105	3/41			
TA566	1TNE968901R3107	3/41			
TA570	1TNE968901R3203	3/41			
TA571-SIM	1TNE968903R0203	3/41			
TA574-A-R	1SAP186200R0002	11/165			
TA574-A-R-AC	1SAP186200R0001	11/165			
TA574-A-T	1SAP186200R0003	11/165			
TA574-D-T-ETH	1SAP186200R0004	11/165			
TB421-ETH-XC	1SAP314100R0270	5/89			
TB511-ETH	1SAP111100R0270	4/55			
TB511-ETH-XC	1SAP311100R0270	5/89			
TB521-ETH	1SAP112100R0270	4/55			
TB521-ETH-XC	1SAP312100R0270	5/89			
TB523-2ETH	1SAP112300R0277	4/55			
TB541-ETH	1SAP114100R0270	4/55			
TK401	1SBN260216R1001	7/133			
TK402	1SBN260217R1001	7/133			
TK405	1SBN260221R1001	7/133			
TK406	1SBN260224R1001	7/133			
TK501	1SAP180200R0001	4/60			
TK502	1SAP180200R0101	4/60			
TK503	1TNE968901R1100	3/41			
TK504	1TNE968901R2100	3/41			
TK506	1SAP186100R0001	3/41			
TK681	1SAP500981R0001	7/133			
TK682	1SAP500982R0001	7/133			

Contact us

ABB Automation Products GmbH

Wallstadter Str. 59

D-68526 Ladenburg / Germany

Tel.: +49 62 21 701 1444

Fax: +49 62 21 701 1382

E-Mail: plc.sales@de.abb.com



www.abb.com/plc

Note

We reserve the right to make technical changes or modify the contents of this document without prior notice.

ABB does not accept any responsibility whatsoever for potential errors or possible lack of information in this document.

We reserve all rights in this document and in the subject matter and illustrations contained therein. Any reproduction, disclosure to third parties or utilization of its contents – in whole or in parts – is forbidden without prior written consent of ABB.

Copyright© 2014 ABB - All rights reserved

