

Ekip Display

User and operator manual for
display for protection releases
Tmax XT series

Ekip Display

User and operator manual

INDEX

1	User interface.....	4
1.1	<i>Legend.....</i>	5
2	Signalling icons	5
3	Default page	7
4	Main menu detail.....	8
4.1	Main menu.....	8
4.1.1	Menu structure	8
4.1.2	Available submenus	9
4.2	'Measures' menu	10
4.2.1	Menu structure	10
4.2.2	Available submenus	10
4.3	'Parameters' menu	11
4.3.1	Menu structure	11
4.3.2	Available submenus.....	11
4.3.3	'Manual set parameters' menu.....	12
4.3.4	'Electronic set parameters' menu.....	20
4.3.5	'Configuration set parameters' menu.....	37
4.4	'Communication' menu.....	40
4.4.1	Menu structure	40
4.4.2	Available parameters	40
4.4.3	'Slave address' parameter.....	41
4.4.4	'Code' parameter	41
4.4.5	'Baudrate' parameter	41
4.4.6	Communication parameter programming example.....	42
4.5	'History' menu.....	43
4.5.1	Menu structure	43
4.5.2	Available submenus	43
4.5.3	'Trip history' menu	44
4.6	'Information' menu	45
4.6.1	Menu structure	45
4.6.2	Available submenus.....	45
4.6.3	'CB information' menu.....	46
4.6.4	'TRIP UNIT information' menu	46
4.6.5	'DISPLAY information' menu	46
4.7	'Settings' menu	47
4.7.1	Menu structure	47
4.7.2	Available submenus.....	47
4.7.3	'Autotest' menu	48
4.7.4	'Buttons test' menu	49
4.7.5	'MIN/MAX reset' menu	49
4.7.6	'ENERGY reset' menu	50
4.8	'Trip test' menu.....	51
4.8.1	Menu structure	51
5	Miscellaneous information.....	52
5.1	Display features.....	52
5.2	Backlight features.....	52
5.3	'Power' led features.....	53
5.4	Ekip TT or Ekip T&P unit connection.....	53
5.4.1	Ekip TT or Ekip T&P connection procedure	54

Version	L5048			Apparatus	Ekip Display	Language	EN
	L5975						
ABB				Doc. No	1SDH000892R0002	Pag. No	2/54

ABBREVIATIONS

Tmax XT	New series of moulded case breakers from ABB SACE
CB	Circuit Breaker
TU	Trip Unit
TC	Trip Coil
PTC	Rotor thermal protection
Ekip LSI	Protection relay for ABB SACE Tmax XT CB series
Ekip LSIg	Protection relay for ABB SACE Tmax XT CB series
Ekip M-LRIU	Protection relay for ABB SACE Tmax XT CB series
Ekip E-LSIG	Protection relay for ABB SACE Tmax XT CB series
Ekip TT	ABB SACE test unit
Ekip T&P	ABB SACE communication unit
rms	Root Mean Square value
s/n	Serial number
SW	Software

Version	L5048		Apparatus	Ekip Display	Language
	L5975				EN
ABB			Doc. No	1SDH000892R0002	Pag. No 3/54

1 User interface

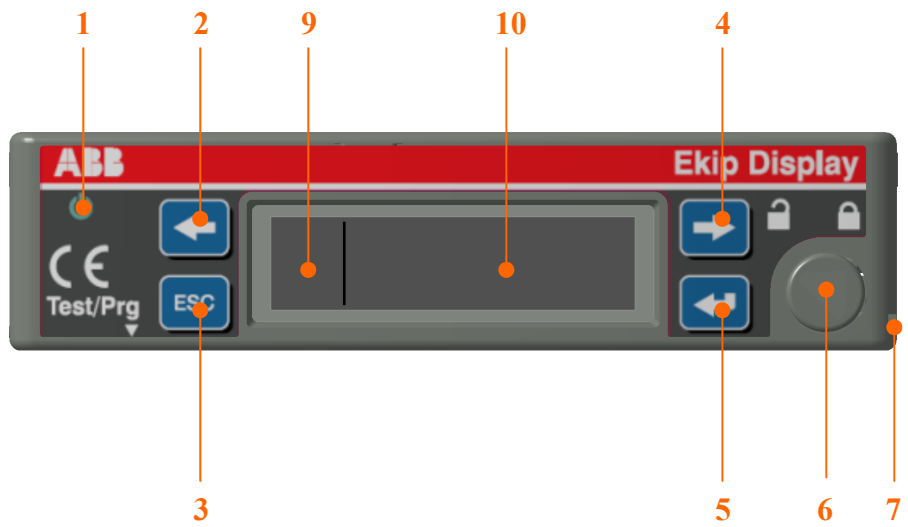





Version	L5048			Apparatus	Ekip Display	Language EN
	L5975					
ABB				Doc. No	1SDH000892R0002	Pag. No 4/54

1.1 Legend















Ref.	Description	Notes
1	'Power' led	
2	'Left' cursor button	
3	Exit or cancellation 'Esc' button	
4	'Right' cursor button	
5	Confirm 'Enter' button	
6	Mechanical fastening	
7	Sealing slot	
8	Ekip TT or Ekip T&P connector	
9	Signalling icons display area	See Par. 2: Signalling icons
10	Menu display area	See Par. 4: main menu detail
11	TU connector	

Tab. 1: user interface

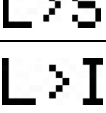
2 Signalling icons

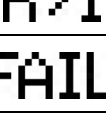
Signalling icons table					
Symbol	Description	Ekip LSI	Ekip LSIG	Ekip M-LRIU	Ekip E-LSIG
MAN	Manual parameters selected	✓	✓	✓	✓
ELT	Electronic parameters selected	✓	✓	✓	✓
REM	Remote mode selected	✓	✓	✗	✓
LOC	Local mode selected	✓	✓	✗	✓
	Auxiliary power supply presence	✓	✓	✓	✓
PL 	L prealarm	✓	✓	✓	✓
L 	L timing	✓	✓	✓	✓
S 	S timing	✓	✓	✗	✓
G 	G timing	✗	✓	✓	✓

Version	L5048			Apparatus	Ekip Display	Language EN
	L5975					
ABB				Doc. No	1SDH000892R0002	Pag. No 5/54

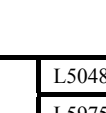
Signalling icons table					
Symbol	Description	Ekip LSI	Ekip LSI ^G	Ekip M-LRIU	Ekip E-LSIG
	R (stall) timing R (jam) timing	✗	✗	✓	✗
	U (unbalance) timing	✗	✗	✓	✗
	U (undercurrent) timing	✗	✗	✓	✗
	U (phase loss) timing	✗	✗	✓	✗
	OV/UV timing UV/OV alarm	✗	✗	✗	✓
	PTC timing	✗	✗	✓	✗
	No communication between TU and display	✓	✓	✓	✓
	TC not connected	✓	✓	✓	✓
	ERROR: protection parameters incongruency TU programming failed	✓	✓	✗	✓
		✓	✓	✓	✓
		✓	✓	✗	✓
		✗	✗	✓	✗
	TU programming failed	✓	✓	✓	✓
	TU programming correctly saved	✓	✓	✓	✓
	TU programming correctly saved with manual parameters selected	✓	✓	✓	✓

Tab. 2: icons

Version	L5048			Apparatus	Ekip Display	Language EN
	L5975					
ABB				Doc. No	1SDH000892R0002	Pag. No 6/54

3 Default page

Ekip Display default page shows a phase with higher current and its value, expressed in ampere rms (A):

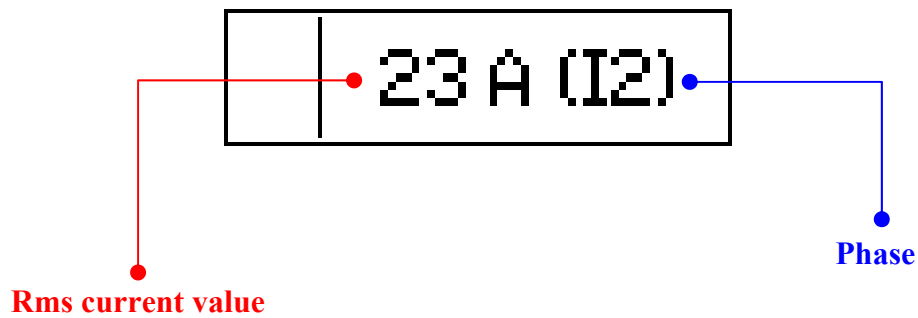

In case there is no current on all phases, is showed the following page:

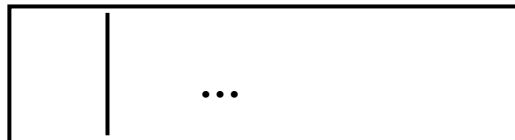

Version	L5048			Apparatus	Ekip Display	Language EN
	L5975					
ABB				Doc. No	1SDH000892R0002	Pag. No 7/54

4 Main menu detail





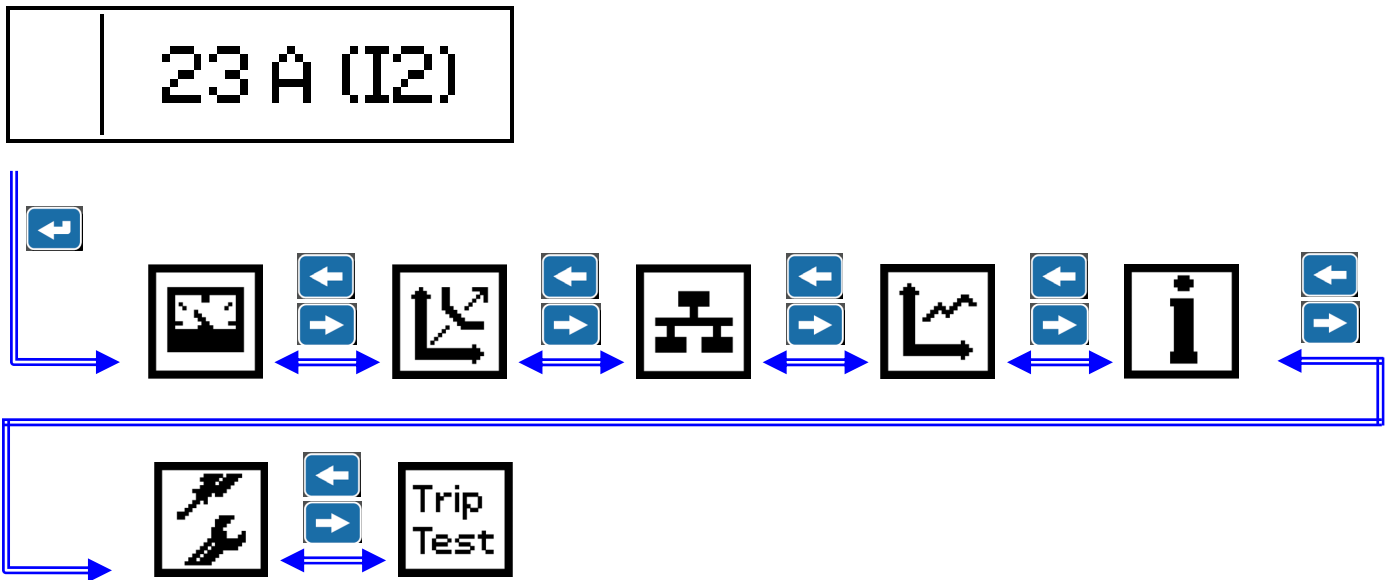

4.1 Main menu

4.1.1 Menu structure



Version	L5048			Apparatus	Ekip Display	Language EN
	L5975					
ABB				Doc. No	1SDH000892R0002	Pag. No 8/54

4.1.2 Available submenus

Available submenus			
Symbol	Name	Description	Par.
	Measures	Show the measures related to the CB connected to the display	4.2
	Parameters	Show and edit protection and configuration settings of the TU connected to the display	4.3
	Communication	Show and edit communication settings for the TU connected to the display	4.4
	History	Show historical trip information of the TU	4.5
	Information	Show serial number and information about CB, TU and display	4.6
	Settings	Enter the display self-test procedures menu	4.7
	Trip test	Enter the CB trip test menu	4.8

Version	L5048			Apparatus	Ekip Display	Language EN
	L5975					
ABB				Doc. No	1SDH000892R0002	Pag. No 9/54

4.2 'Measures' menu

Show the runtime current values of all phases.

4.2.1 Menu structure

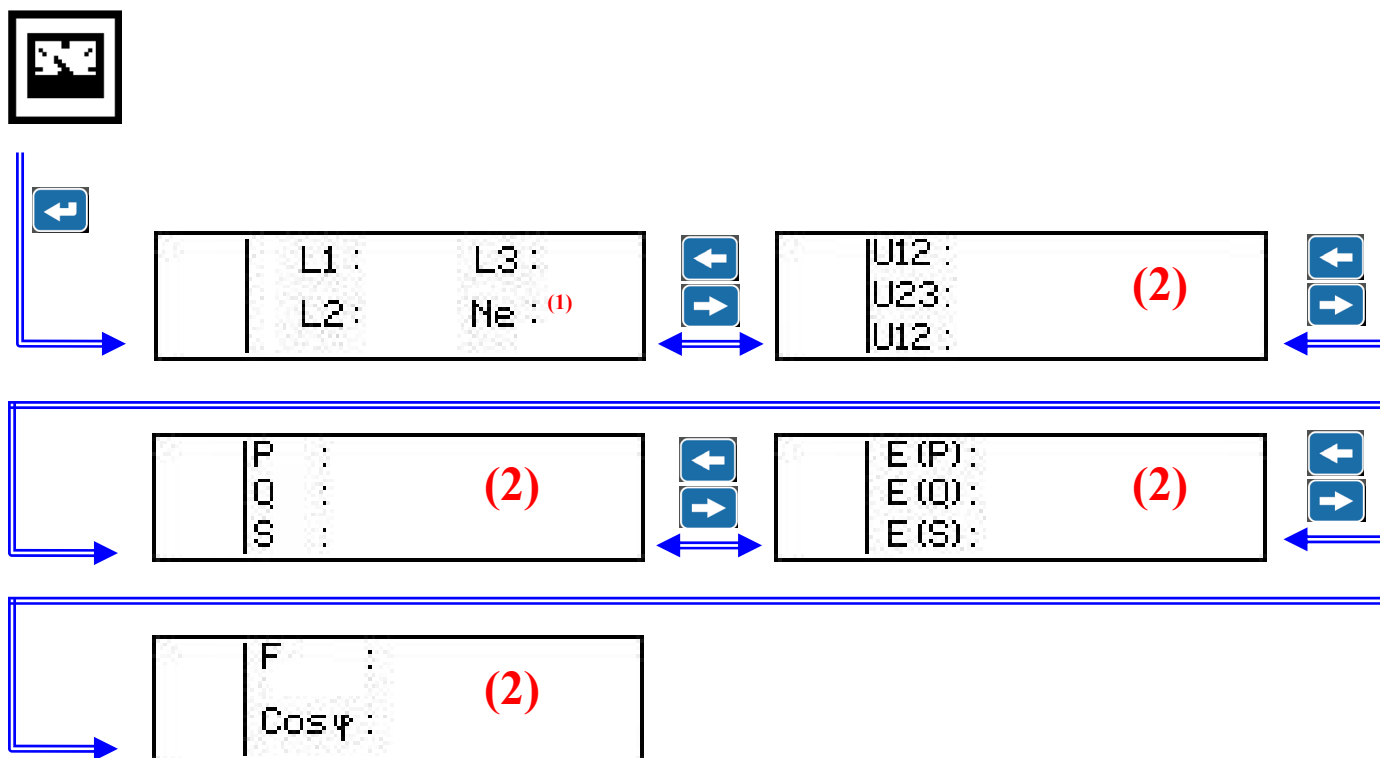

(1) Not available for 'Ekip M-LRIU' TU type

(2) Available for 'Ekip E-LSIG' TU type only

4.2.2 Available submenus

Accessing this menu (see par. 4.2.1) you can see:

- the runtime value, expressed in ampere rms (A), of the phases current of the system which the TU is connected.
- the runtime value, expressed in volt rms (V), of the phase voltages of the system which the TU is connected.⁽¹⁾
- the runtime value, expressed in watt - reactive voltampere - voltampere rms (W – Var - VA), of the total power of the system which the TU is connected.⁽¹⁾
- the runtime value, expressed in kilowatt/hour – reactive kilovoltampere/hour - kilovoltampere/hour rms (kWh – kVARh - kVAh), of the total energy of the system which the TU is connected.⁽¹⁾
- the runtime value, expressed in hertz (Hz), of the frequency and the runtime value of the phase displacement $\cos\varphi$ of the system which the TU is connected.⁽¹⁾

(1) Available for 'Ekip E-LSIG' TU type only

Version	L5048			Apparatus	Ekip Display	Language EN
	L5975					
ABB				Doc. No	1SDH000892R0002	Pag. No 10/54

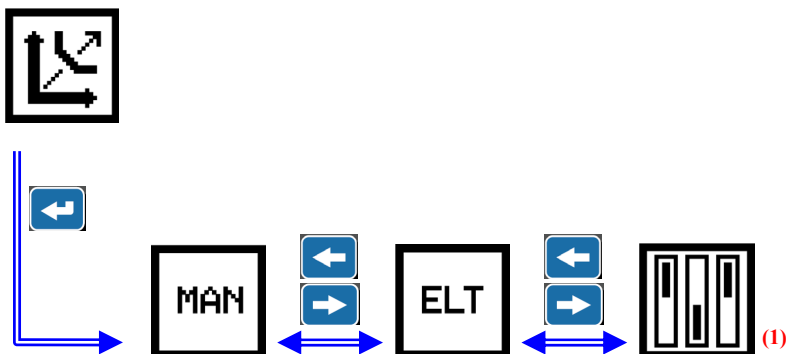

4.3 'Parameters' menu

4.3.1 Menu structure



(1) Not available for 'Ekip LSI', 'Ekip LSIG' and 'Ekip LSIG' TU type

4.3.2 Available submenus

Available submenus			
Symbol	Name	Description	Par.
	Manual set parameters	Show the protection settings made by dip-switch on the TU connected to the display	4.3.3
	Electronic set parameters	Show and edit protection settings stored in the TU connected to the display	4.3.4
	Configuration set parameters ⁽¹⁾	Show and edit configuration settings stored in the TU connected to the display	4.3.5

(1) Not available for 'Ekip LSI', 'Ekip LSIG' and 'Ekip LSIG' TU type

Version	L5048		Apparatus	Ekip Display	Language EN
	L5975				
ABB			Doc. No	1SDH000892R0002	Pag. No 11/54

4.3.3 'Manual set parameters' menu

Accessing this menu is showed the protection setting made by dip-switch on the TU connected to the display.

4.3.3.1 Menu structure

The submenus available are different depending of the TU type connected to the display.

In case of use of 'Ekip LSI', 'Ekip LSIG' o 'Ekip E-LSIG' TU type the following structure is available:

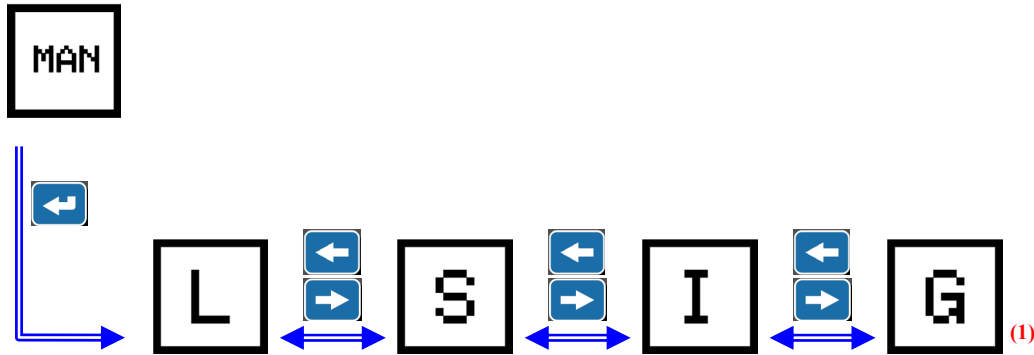

(1) Not available for 'Ekip LSI' and 'Ekip E-LSIG' TU type



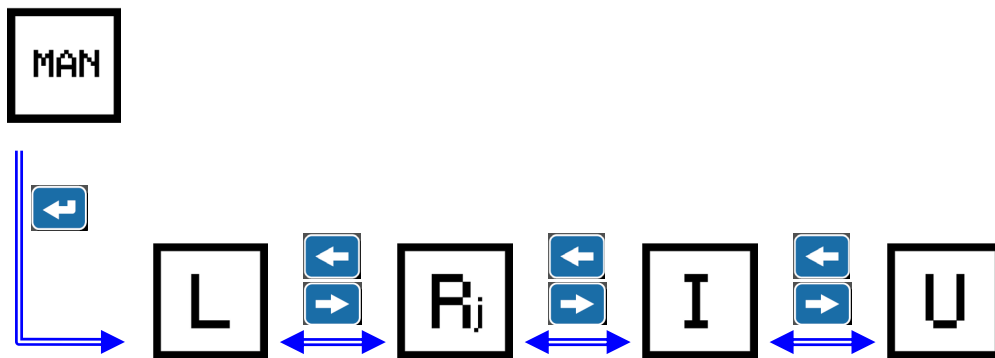

In case of use of 'Ekip M-LRIU' TU type the following structure is available:



Version	L5048		Apparatus	Ekip Display	Language EN
	L5975				
ABB			Doc. No	1SDH000892R0002	Pag. No 12/54





4.3.3.2 Available submenus

The submenus available are different depending of the TU type connected to the display.
In case of use of 'Ekip LSI', 'Ekip LSIG' or 'Ekip E-LSIG' TU type the following structure is available:

Available submenus			
Symbol	Name	Description	Par.
	L protection	Show the manual settings for protection against overloading made by dip-switch on the TU connected to the display	4.3.3.3
	S protection	Show the manual settings for protection against short circuit with adjustable delay made by dip-switch on the TU connected to the display	4.3.3.4
	I protection	Show the manual settings for istantaneous protection against short circuit made by dip-switch on the TU connected to the display	4.3.3.5
	G protection⁽¹⁾	Show the manual settings for protection against ground fault made by dip-switch on the TU connected to the display	4.3.3.6

⁽¹⁾ Not available for 'Ekip LSI' and 'Ekip E-LSIG' TU type

In case of use of 'Ekip M-LRIU' TU type the following structure is available:

Available submenus			
Symbol	Name	Description	Par.
	L protection	Show the manual settings for protection against overloading made by dip-switch on the TU connected to the display	4.3.3.3
	R (jam) protection	Show the manual settings for protection against rotor jam made by dip-switch on the TU connected to the display	4.3.3.7
	I protection	Show the manual settings for istantaneous protection against short circuit made by dip-switch on the TU connected to the display	4.3.3.5
	U (phase loss) protection	Show the manual settings for protection against phase loss made by dip-switch on the TU connected to the display	4.3.3.8

Version	L5048		Apparatus	Ekip Display	Language EN
	L5975				
ABB			Doc. No	1SDH000892R0002	Pag. No 13/54

4.3.3.3 Manual 'L' protection parameters

Show the manual settings for protection against overload 'L' made by dip-switch on the TU connected to the display.

This protection is available for 'Ekip LSI', 'Ekip LSIG', 'Ekip M-LRIU' and 'Ekip E-LSIG' TU type.

4.3.3.3.1 Structure

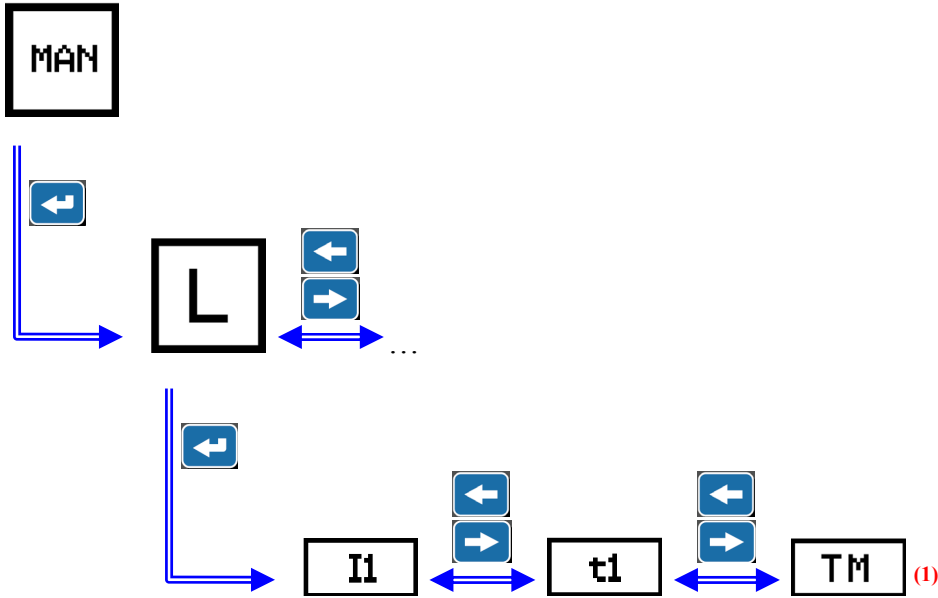

(1) Not available for 'Ekip M-LRIU' and 'Ekip E-LSIG' TU type

4.3.3.3.2 Available parameters

Symbol	Name
I1	Manual L threshold
t1	Manual L time
TM	Thermal memory status (1)

(1) Not available for 'Ekip M-LRIU' and 'Ekip E-LSIG' TU type

Version	L5048		Apparatus	Ekip Display	Language EN
	L5975				
ABB			Doc. No	1SDH000892R0002	Pag. No 14/54

4.3.3.4 Manual 'S' protection parameters

Show the manual settings for protection against short circuit with adjustable delay 'S' made by dip-switch on the TU connected to the display.

This protection is available for 'Ekip LSI', 'Ekip LSIG' and 'Ekip E-LSIG' TU type.

4.3.3.4.1 Structure

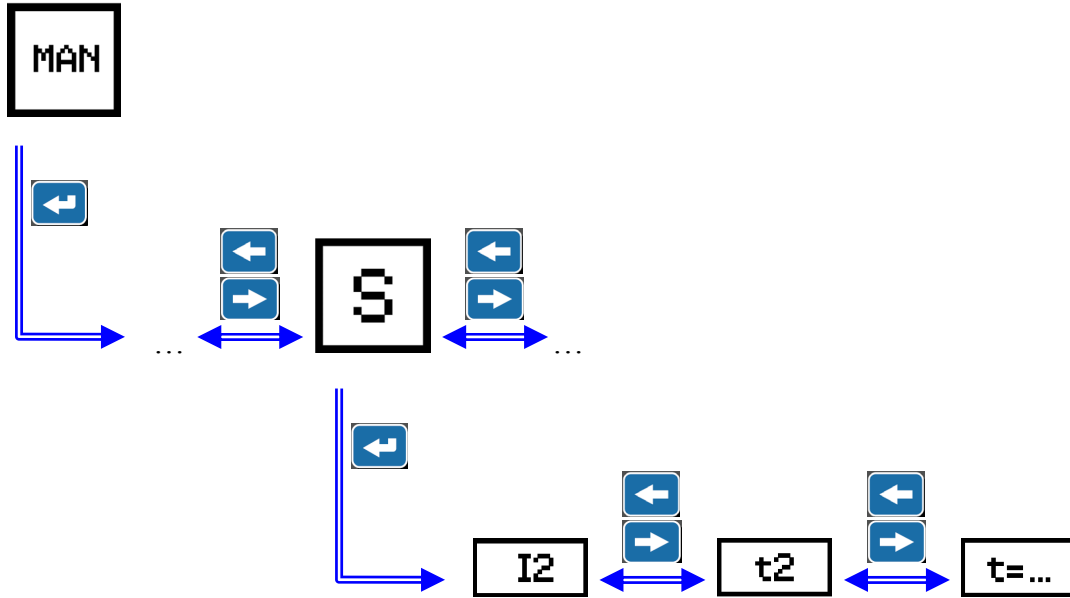

4.3.3.4.2 Available parameters

Symbol	Name
I2	Manual S threshold
t2	Manual S time
t=...	Manual S protection curve type

Version	L5048		Apparatus	Ekip Display	Language EN
	L5975				
ABB			Doc. No	1SDH000892R0002	Pag. No 15/54

4.3.3.5 Manual 'I' protection parameters

Show the manual settings for instantaneous protection against short circuit 'I' made by dip-switch on the TU connected to the display.

This protection is available for 'Ekip LSI', 'Ekip LSIG', 'Ekip M-LRIU' and 'Ekip E-LSIG' TU type.

4.3.3.5.1 Structure

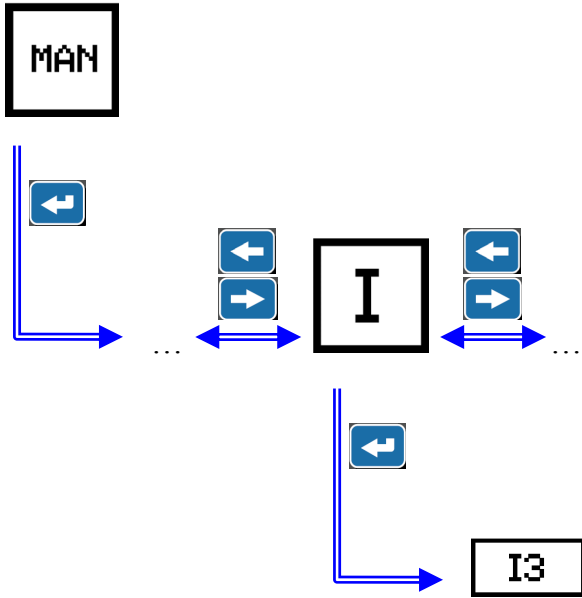

4.3.3.5.2 Available parameters

Symbol	Name
I3	Manual I protection status

Version	L5048			Apparatus	Ekip Display	Language	EN
	L5975						
ABB				Doc. No	1SDH000892R0002	Pag. No	16/54

4.3.3.6 Manual 'G' protection parameters

Show the manual settings for protection against ground fault 'G' made by dip-switch on the TU connected to the display.

This protection is available only for 'Ekip LSIG' TU type.

4.3.3.6.1 Structure

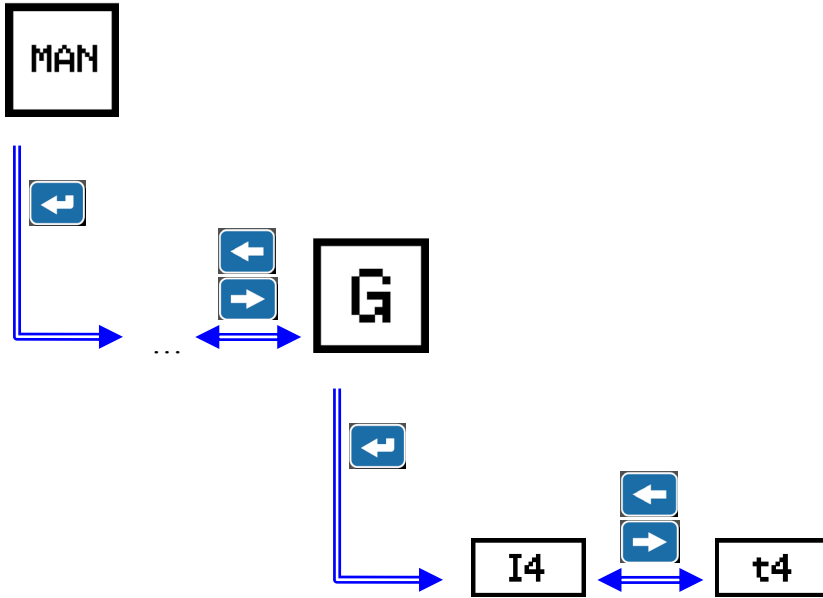

4.3.3.6.2 Available parameters

Symbol	Name
I4	Manual G threshold
t4	Manual G time

Version	L5048		Apparatus	Ekip Display	Language EN
	L5975				
ABB			Doc. No	1SDH000892R0002	Pag. No 17/54

4.3.3.7 Manual 'R (jam)' protection parameters

Show the manual settings for protection against rotor jam 'R (jam)' made by dip-switch on the TU connected to the display.

This protection is available only for 'Ekip M-LRIU' TU type.

4.3.3.7.1 Structure

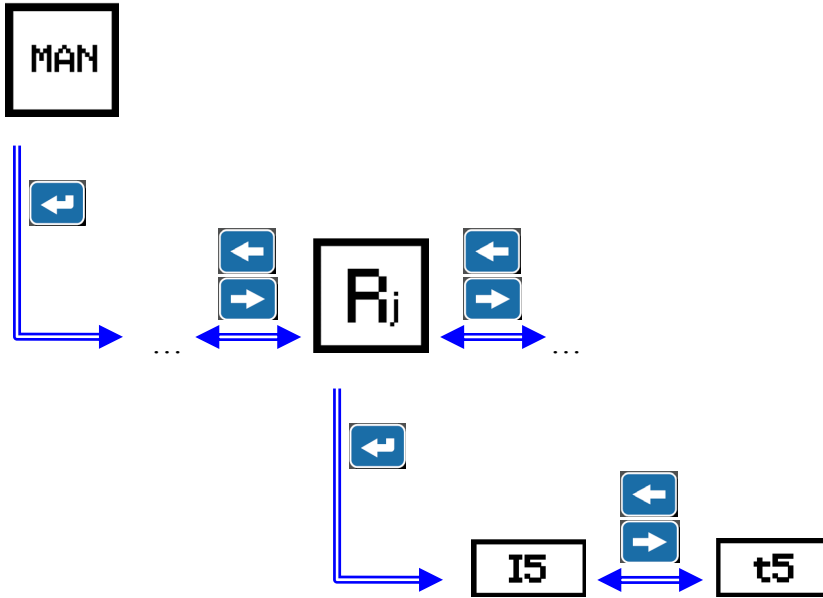

4.3.3.7.2 Available parameters

Symbol	Name
I5	Manual R (jam) threshold
t5	Manual R (jam) time

Version	L5048		Apparatus	Ekip Display	Language EN
	L5975				
ABB			Doc. No	1SDH000892R0002	Pag. No 18/54

4.3.3.8 Protection parameters ‘U (phase loss)’ manuals

Show the manual settings for protection against phase loss ‘U (phase loss)’ made by dip-switch on the TU connected to the display.

This protection is available only for ‘Ekip M-LRIU’ TU type.

4.3.3.8.1 Structure

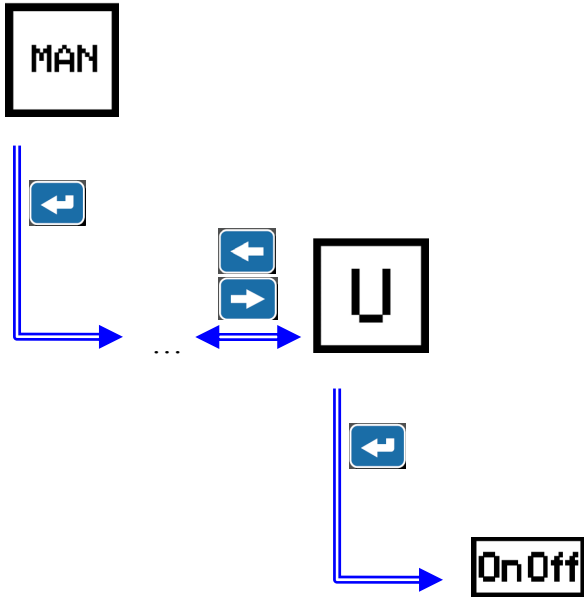

4.3.3.8.2 Available parameters

Symbol	Name
OnOff	Manual U (phase loss) protection status

Version	L5048		Apparatus	Ekip Display	Language EN
	L5975				
ABB			Doc. No	1SDH000892R0002	Pag. No 19/54

4.3.4 'Electronic set parameters' menu

Accessing this menu is possible to show and edit the protection settings stored in the TU connected to the display.

4.3.4.1 Menu structure

The submenus available are different depending of the TU type connected to the display. In case of use of 'Ekip LSI' or 'Ekip LSIG' TU type the following structure is available:

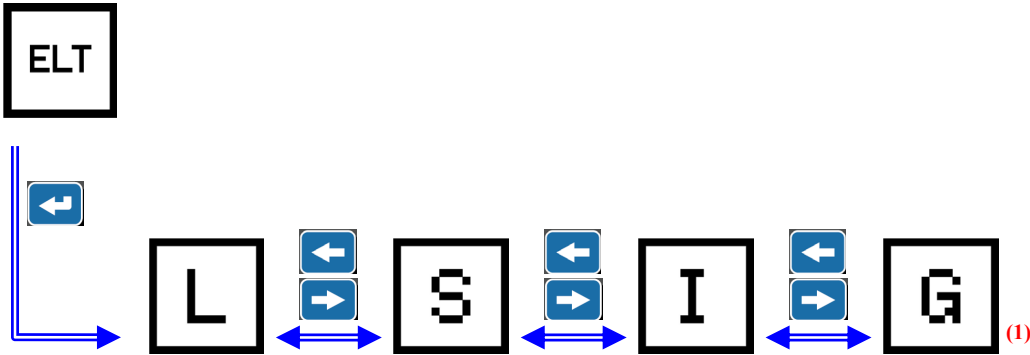

(1) Not available for 'Ekip-LSI' TU type

In case of use of 'Ekip M-LRIU' TU type the following structure is available:

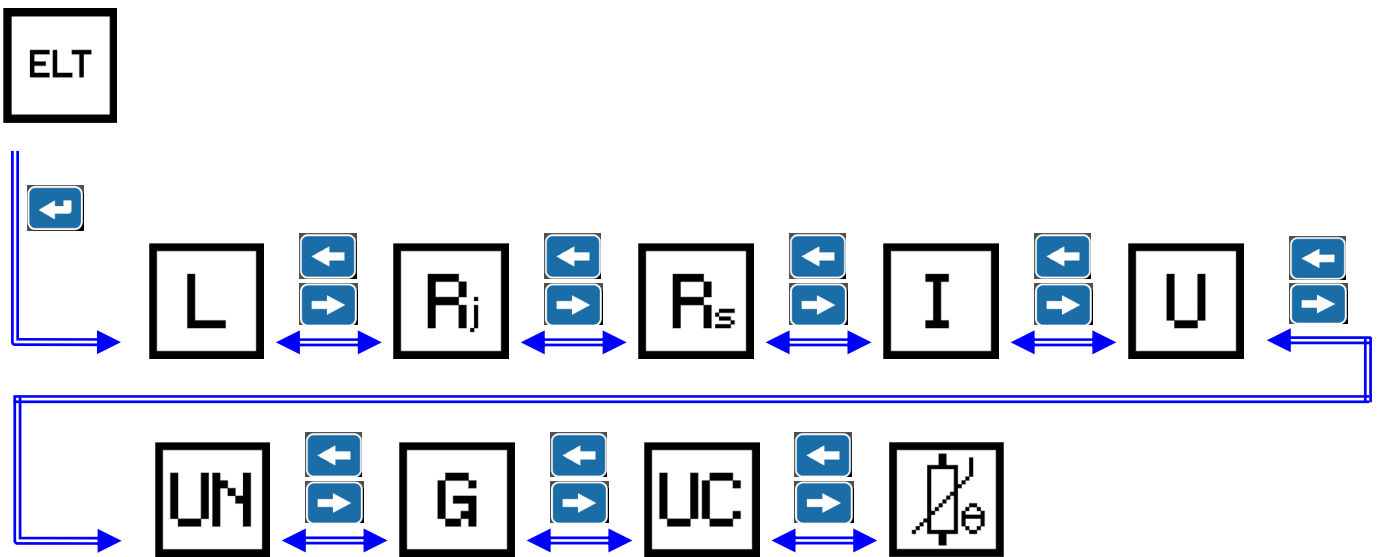

Version	L5048			Apparatus	Ekip Display	Language	EN
	L5975						
ABB				Doc. No	1SDH000892R0002	Pag. No	20/54

In case of use of 'Ekip E-LSIG' TU type the following structure is available:

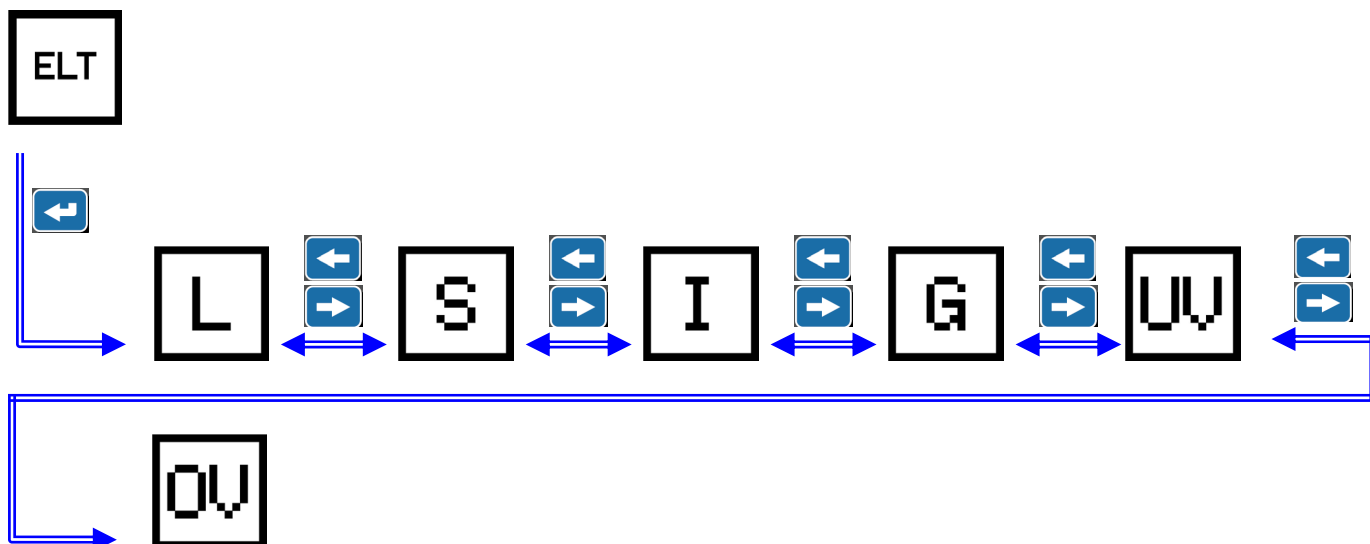

4.3.4.2 Available submenus









The submenus available are different depending of the TU type connected to the display. In case of use of 'Ekip LSI' or 'Ekip LSIG' TU type the following structure is available:

Available submenus			
Symbol	Name	Description	Par.
	L protection	Show and edit the electronic settings for protection against overloading of the TU connected to the display	4.3.4.3
	S protection	Show and edit the electronic settings for protection against short circuit with adjustable delay of the TU connected to the display	4.3.4.4
	I protection	Show and edit the electronic settings for instantaneous protection against short circuit of the TU connected to the display	4.3.4.5
	G protection⁽¹⁾	Show and edit the electronic settings for protection against ground fault of the TU connected to the display	4.3.4.6

⁽¹⁾ Not available for 'Ekip-LSI' TU type







Version	L5048		Apparatus	Ekip Display	Language EN
	L5975				
ABB			Doc. No	1SDH000892R0002	Pag. No 21/54

In case of use of 'Ekip M-LRIU' TU type the following structure is available:

Available submenus			
Symbol	Name	Description	Par.
	L protection	Show and edit the electronic settings for protection against overloading of the TU connected to the display	4.3.4.3
	R (jam) protection	Show and edit the electronic settings for protection against rotor jam of the TU connected to the display	4.3.4.7
	R (stall) protection	Show and edit the electronic settings for protection against stall of the TU connected to the display	4.3.4.8
	I protection	Show and edit the electronic settings for instantaneous protection against short circuit of the TU connected to the display	4.3.4.5
	U (phase loss) protection	Show and edit the electronic settings for protection against phase loss of the TU connected to the display	4.3.4.9
	U (unbalance) protection	Show and edit the electronic settings for protection against current unbalance of the TU connected to the display	4.3.4.10
	G protection	Show and edit the electronic settings for protection against ground fault of the TU connected to the display	4.3.4.6
	U (undercurrent) protection	Show and edit the electronic settings for protection against undercurrent of the TU connected to the display	4.3.4.11
	PTC protection	Show and edit the electronic settings for PTC protection of the TU connected to the display	4.3.4.12

Version	L5048		Apparatus	Ekip Display	Language EN
	L5975				
ABB			Doc. No	1SDH000892R0002	Pag. No 22/54

In case of use of 'Ekip E-LSIG' TU type the following structure is available:

Available submenus			
Symbol	Name	Description	Par.
	L protection	Show and edit the electronic settings for protection against overloading of the TU connected to the display	4.3.4.3
	S protection	Show and edit the electronic settings for protection against short circuit with adjustable delay of the TU connected to the display	4.3.4.4
	I protection	Show and edit the electronic settings for instantaneous protection against short circuit of the TU connected to the display	4.3.4.5
	G protection	Show and edit the electronic settings for protection against ground fault of the TU connected to the display	4.3.4.6
	UV protection	Show and edit the electronic settings for protection against undervoltage of the TU connected to the display	4.3.4.13
	OV protection	Show and edit the electronic settings for protection against overvoltage of the TU connected to the display	4.3.4.14

Version	L5048			Apparatus	Ekip Display	Language EN
	L5975					
ABB				Doc. No	1SDH000892R0002	Pag. No 23/54

4.3.4.3 Electronic ‘L’ protection parameters

Show and edit the electronic settings for protection against overload ‘L’ of the TU connected to the display. This protection is available for ‘Ekip LSI’, ‘Ekip LSIg’, ‘Ekip M-LRIU’ and ‘Ekip E-LSIG’ TU type.

4.3.4.3.1 Structure

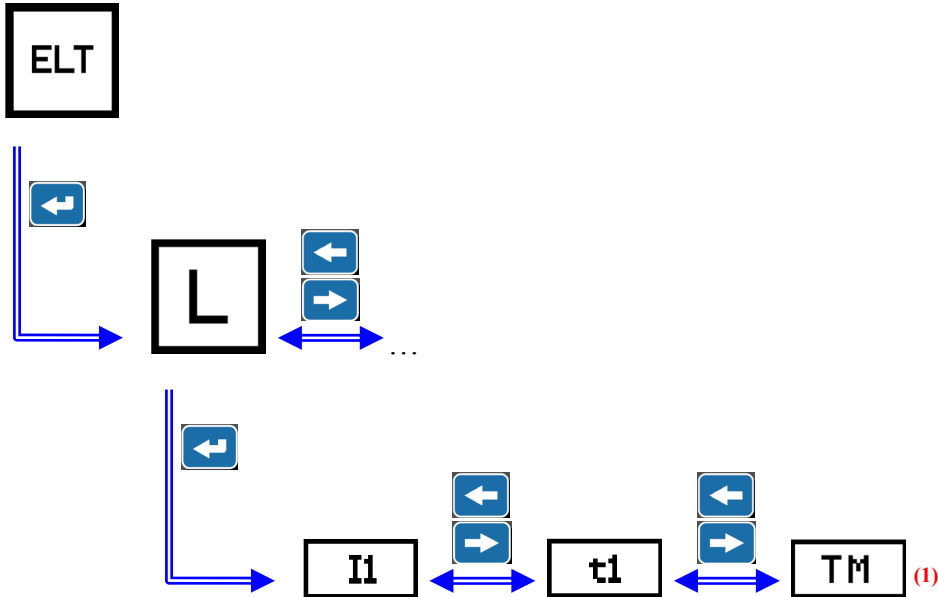

(1) Not available for ‘Ekip M-LRIU’ and ‘Ekip E-LSIG’ TU type

4.3.4.3.2 Available parameters

Symbol	Name
I1	Electronic L threshold
t1	Electronic L time
TM	Thermal memory status ⁽¹⁾

(1) Not available for ‘Ekip M-LRIU’ and ‘Ekip E-LSIG’ TU type

Version	L5048		Apparatus	Ekip Display	Language EN
	L5975				
ABB			Doc. No	1SDH000892R0002	Pag. No 24/54

4.3.4.4 Electronic ‘S’ protection parameters

Show and edit the electronic settings for protection against short circuit with adjustable delay ‘S’ of the TU connected to the display.

This protection is available for ‘Ekip LSI’, ‘Ekip LSIG’ and ‘Ekip E-LSIG’ TU type.

4.3.4.4.1 Structure

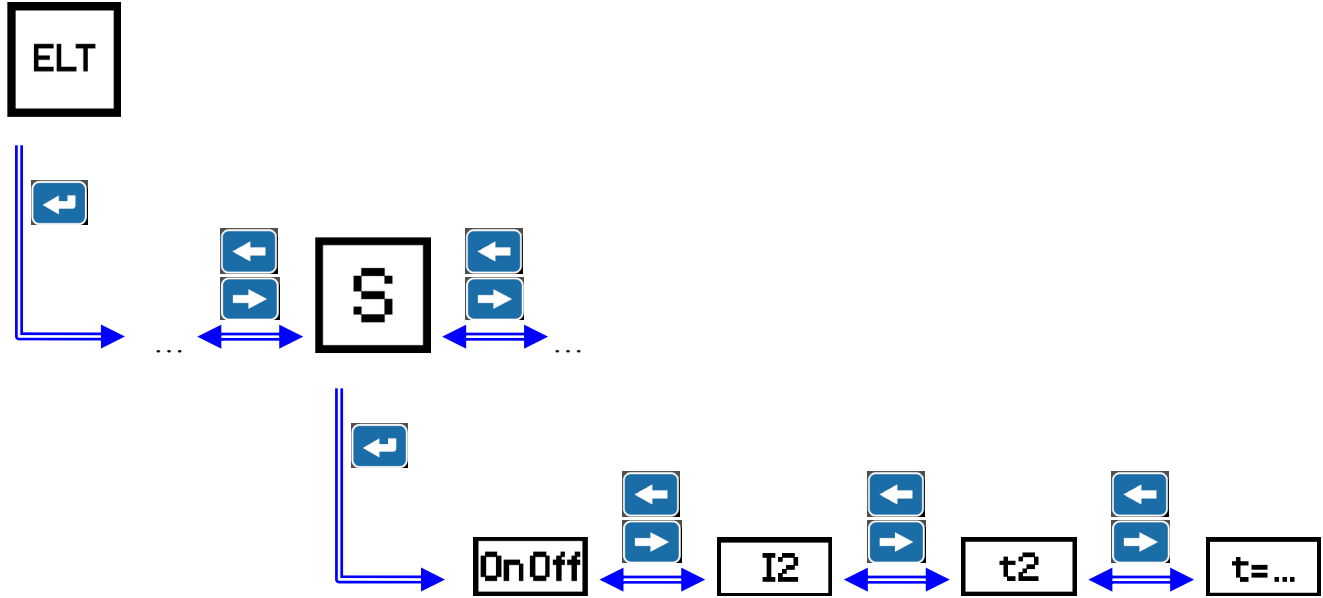

4.3.4.4.2 Available parameters

Symbol	Name
OnOff	Electronic S protection status
I2	Electronic S threshold
t2	Electronic S time
t=...	Electronic S protection curve type

Version	L5048			Apparatus	Ekip Display	Language	EN
	L5975						
ABB				Doc. No	1SDH000892R0002	Pag. No	25/54

4.3.4.5 Electronic ‘I’ protection parameters

Show and edit the electronic settings for instantaneous protection against short circuit ‘I’ of the TU connected to the display.

This protection is available for ‘Ekip LSI’, ‘Ekip LSIG’, ‘Ekip M-LRIU’ and ‘Ekip E-LSIG’ TU type.

4.3.4.5.1 Structure

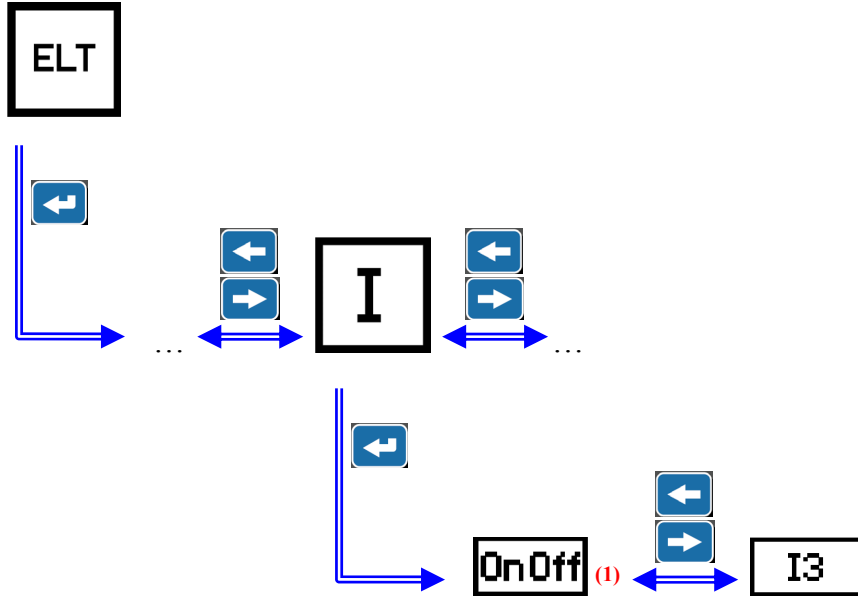

(1) Not available for ‘Ekip M-LRIU’ TU type

4.3.4.5.2 Available parameters

Symbol	Name
OnOff	Electronic I protection status ⁽¹⁾
I3	Electronic I threshold

(1) Not available for ‘Ekip M-LRIU’ TU type

Version	L5048		Apparatus	Ekip Display	Language EN
	L5975				
ABB			Doc. No	1SDH000892R0002	Pag. No 26/54

4.3.4.6 Electronic ‘G’ protection parameters

Show and edit the electronic settings for protection against ground fault ‘G’ of the TU connected to the display.

This protection is available for ‘Ekip LSIG’, ‘Ekip M-LRIU’ and ‘Ekip E-LSIG’ TU type.

4.3.4.6.1 Structure

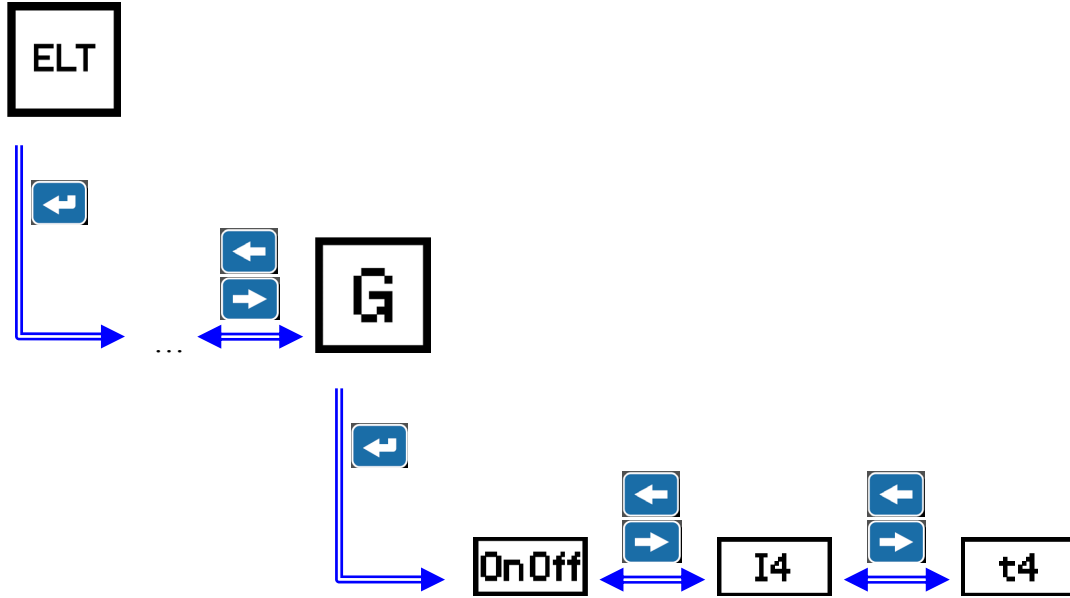

4.3.4.6.2 Available parameters

Symbol	Name
OnOff	Electronic G protection status
I4	Electronic G threshold
t4	Electronic G time

Version	L5048	Apparatus	Ekip Display	Language EN
	L5975			
ABB		Doc. No	1SDH000892R0002	Pag. No 27/54

4.3.4.7 Electronic ‘R (jam)’ protection parameters

Show and edit the electronic settings for protection against rotor jam ‘R (jam)’ of the TU connected to the display.

This protection is available only for ‘Ekip M-LRIU’ TU type.

4.3.4.7.1 Structure

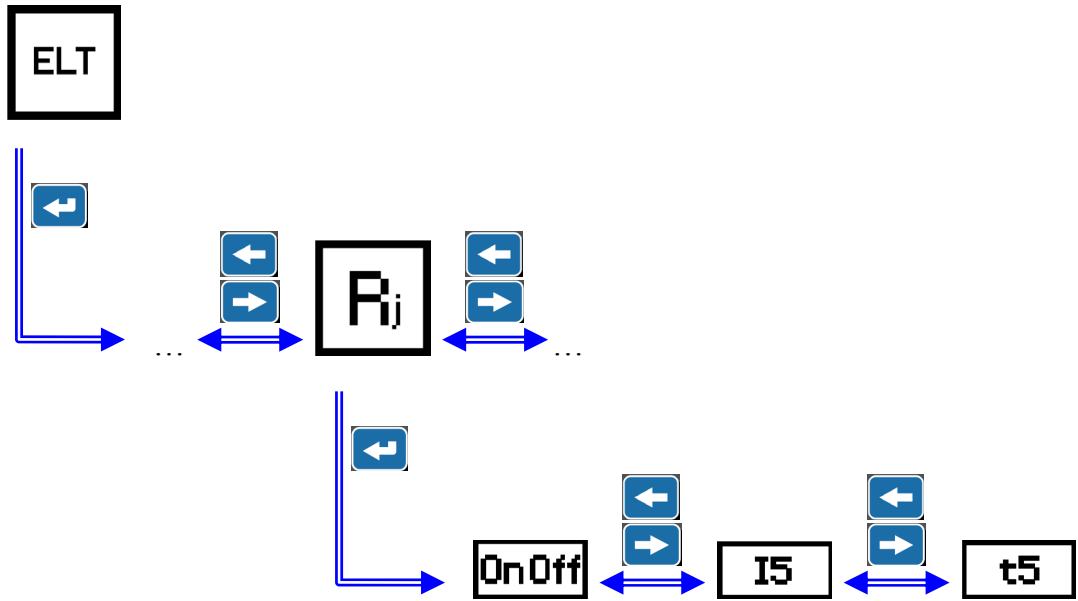

4.3.4.7.2 Available parameters

Symbol	Name
OnOff	Electronic R (jam) protection status
I5	Electronic R (jam) threshold
t5	Electronic R (jam) time

Version	L5048			Apparatus	Ekip Display	Language	EN
	L5975						
ABB				Doc. No	1SDH000892R0002	Pag. No	28/54

4.3.4.8 Electronic ‘R (stall)’ protection parameters

Show and edit the electronic settings for protection against stall ‘R (stall)’ of the TU connected to the display.

This protection is available only for ‘Ekip M-LRIU’ TU type.

4.3.4.8.1 Structure

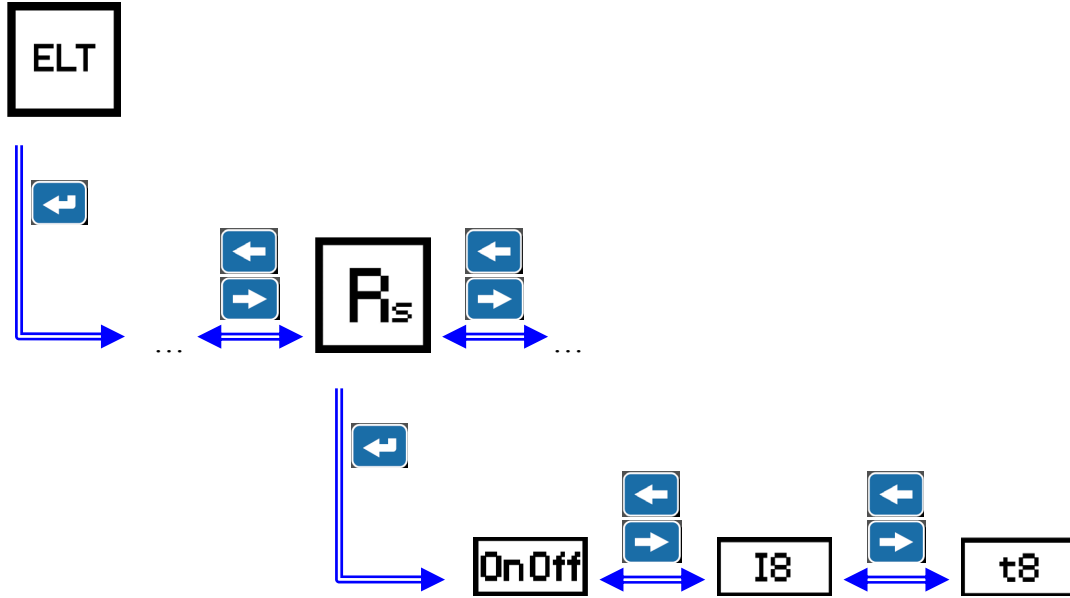

4.3.4.8.2 Available parameters

Symbol	Name
OnOff	Electronic R (stall) protection status
I8	Electronic R (stall) threshold
t8	Electronic R (stall) time

Version	L5048			Apparatus	Ekip Display	Language	EN
	L5975						
ABB				Doc. No	1SDH000892R0002	Pag. No	29/54

4.3.4.9 Electronic ‘U (phase loss)’ protection parameters

Show and edit the electronic settings for protection against phase loss ‘U (phase loss)’ of the TU connected to the display.

This protection is available only for ‘Ekip M-LRIU’ TU type.

4.3.4.9.1 Structure

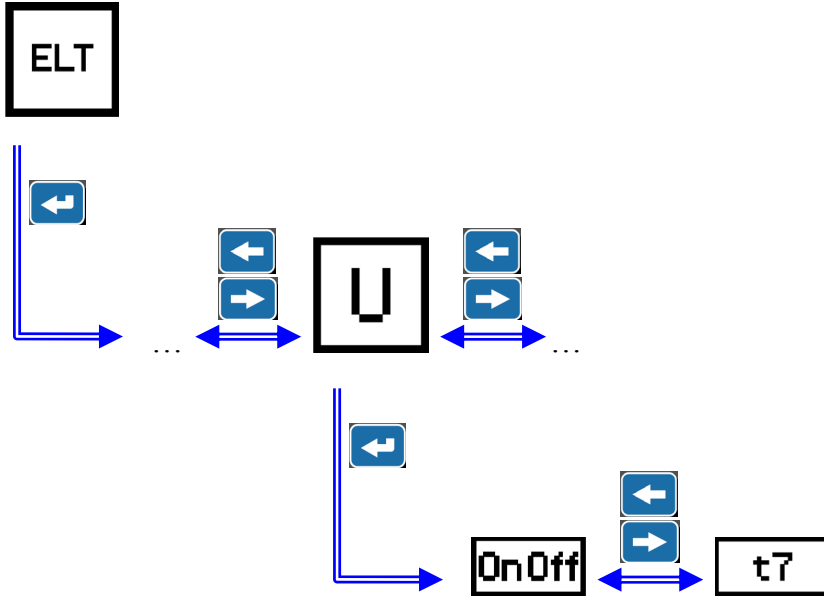

4.3.4.9.2 Available parameters

Symbol	Name
OnOff	Electronic U (phase loss) protection status
t?	Electronic U (phase loss) time

Version	L5048		Apparatus	Ekip Display	Language EN
	L5975				
ABB			Doc. No	1SDH000892R0002	Pag. No 30/54

4.3.4.10 Electronic ‘U (unbalance)’ protection parameters

Show and edit the electronic settings for protection against phase current unbalance ‘U (undercurrent)’ of the TU connected to the display.

This protection is available only for ‘Ekip M-LRIU’ TU type.

4.3.4.10.1 Structure

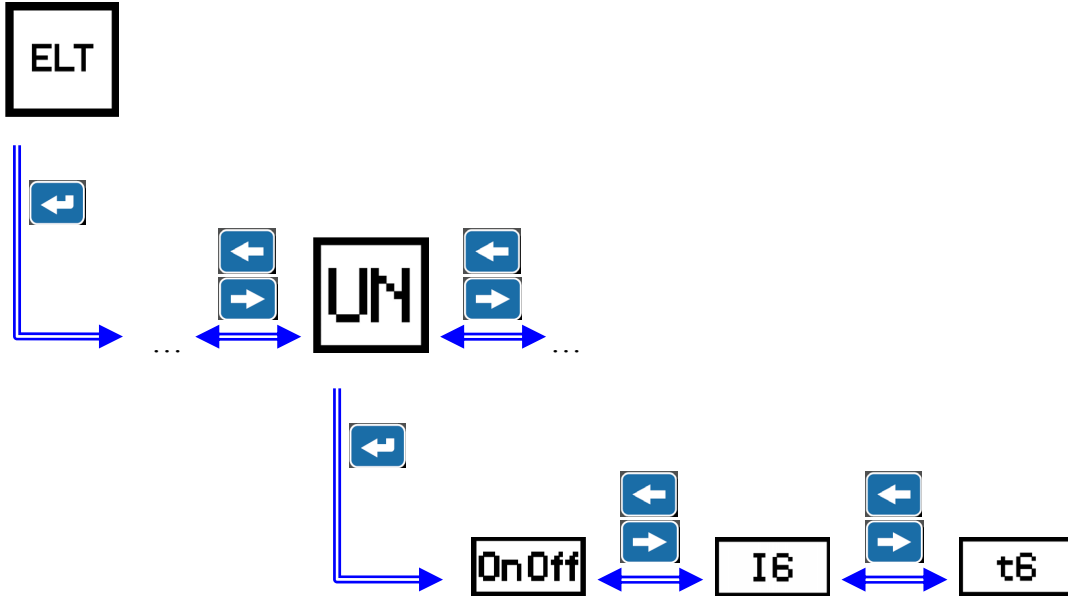

4.3.4.10.2 Available parameters

Symbol	Name
OnOff	Electronic U (unbalance) protection status
I6	Electronic U (unbalance) threshold
t6	Electronic U (unbalance) time

Version	L5048		Apparatus	Ekip Display	Language EN
	L5975				
ABB			Doc. No	1SDH000892R0002	Pag. No 31/54

4.3.4.11 Electronic ‘U (undercurrent)’ protection parameters

Show and edit the electronic settings for protection against undercurrent ‘U (undercurrent)’ of the TU connected to the display.

This protection is available only for ‘Ekip M-LRIU’ TU type.

4.3.4.11.1 Structure

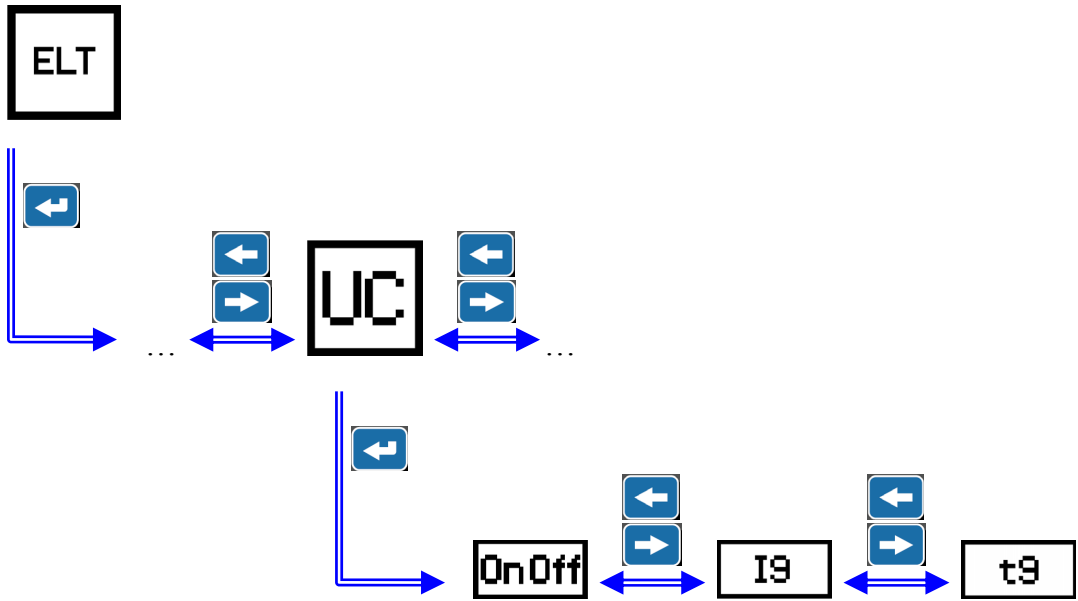

4.3.4.11.2 Available parameters

Symbol	Name
OnOff	Electronic U (undercurrent) protection status
I9	Electronic U (undercurrent) threshold
t9	Electronic U (undercurrent) time

Version	L5048		Apparatus	Ekip Display	Language EN
	L5975				
ABB			Doc. No	1SDH000892R0002	Pag. No 32/54

4.3.4.12 'PTC' protection parameters

Show and edit the electronic settings for 'PTC' protection of the TU connected to the display. This protection is available only for 'Ekip M-LRIU' TU type.

4.3.4.12.1 Structure

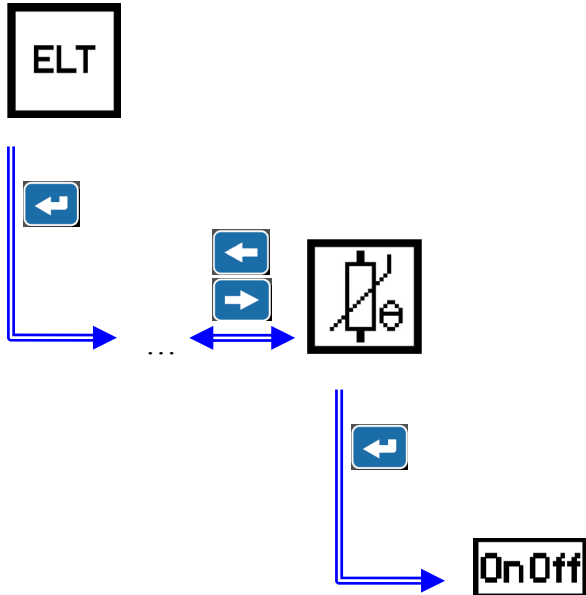

4.3.4.12.2 Available parameters

Symbol	Name
OnOff	PTC protection status

Version	L5048		Apparatus	Ekip Display	Language EN
	L5975				
ABB			Doc. No	1SDH000892R0002	Pag. No 33/54

4.3.4.13 Electronic ‘UV’ protection parameters

Show and edit the electronic settings for protection against undervoltage ‘UV’ of the TU connected to the display.

This protection is available only for ‘Ekip E-LSIG’ TU type.

4.3.4.13.1 Structure

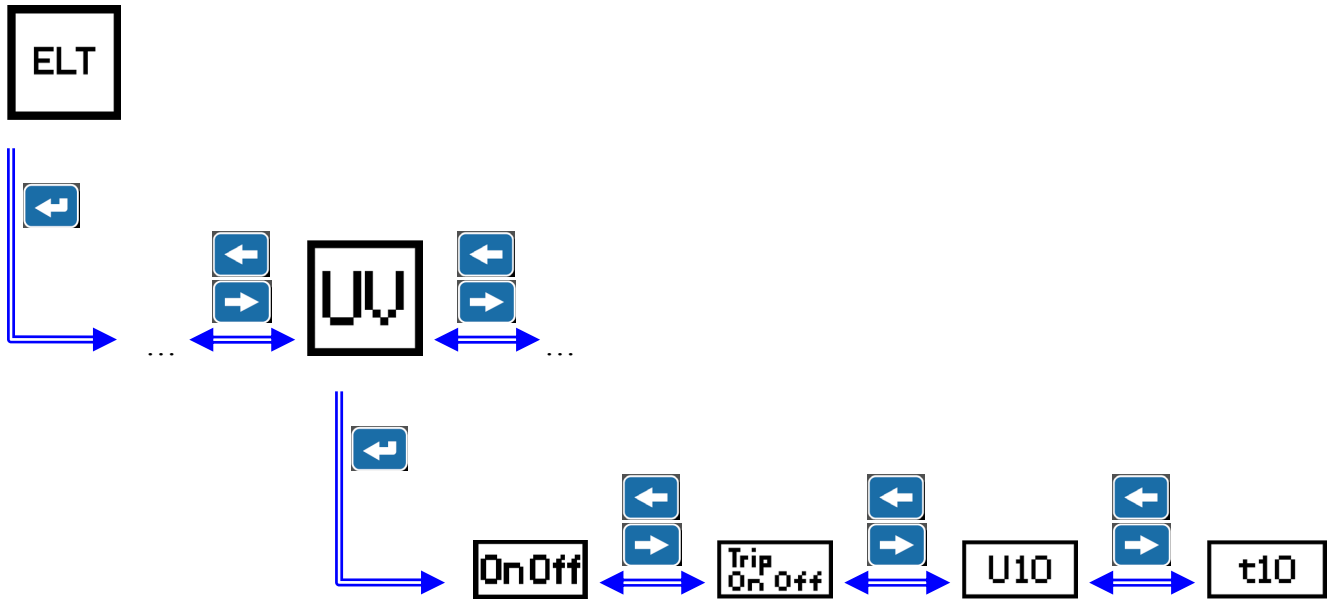

4.3.4.13.2 Available parameters

Symbol	Name
OnOff	Electronic UV protection status
Trip On Off	Electronic UV protection trip status
U10	Electronic UV threshold
t10	Electronic UV time

Version	L5048		Apparatus	Ekip Display	Language EN
	L5975				
ABB			Doc. No	1SDH000892R0002	Pag. No 34/54

4.3.4.14 Electronic ‘OV’ protection parameters

Show and edit the electronic settings for protection against overvoltage ‘OV’ of the TU connected to the display.

This protection is available only for ‘Ekip E-LSIG’ TU type.

4.3.4.14.1 Structure

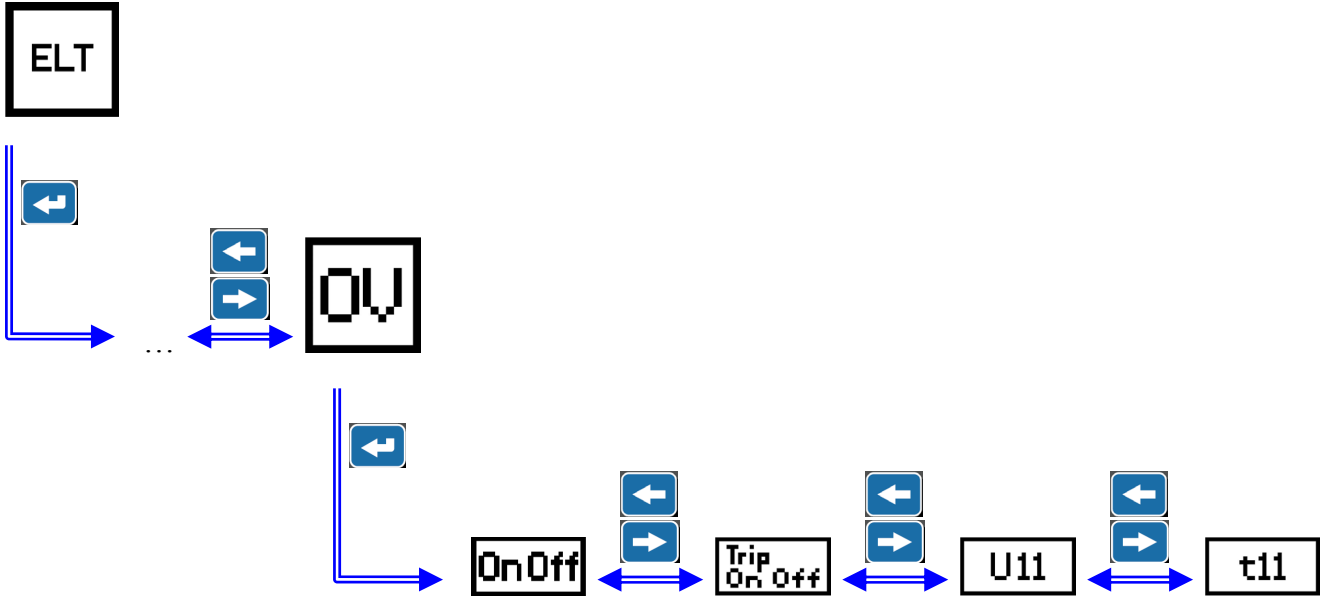

4.3.4.14.2 Available parameters

Symbol	Name
OnOff	Electronic OV protection status
Trip On Off	Electronic OV protection trip status
U11	Electronic OV threshold
t11	Electronic OV time



4.3.4.15 Electronic protection parameters programming example

1. From default page:

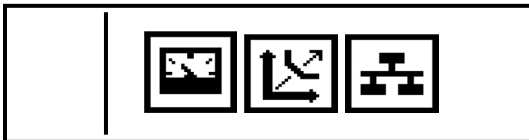

2. press 'Enter'  for access to main menu:



3. move through main menu with 'Right'  and 'Left'  buttons and press 'Enter'  to select 'Parameters' menu:



4. press 'Enter'  to select 'Electronic set parameters' menu:



5. move through 'Electronic set parameters' menu and select 'Electronic L protection' submenu:



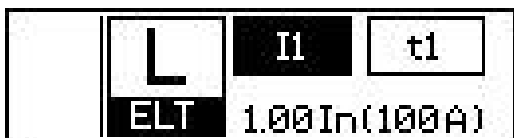

Version	L5048			Apparatus	Ekip Display	Language EN
	L5975					
ABB				Doc. No	1SDH000892R0002	Pag. No 36/54

6. press 'Enter'  to select 'Electronic L threshold (I1) parameter:

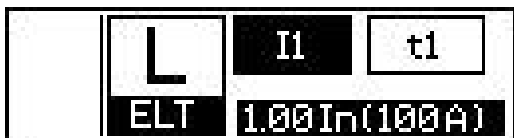

7. using 'Right'  and 'Left'  buttons select the wanted value:



8. press 'Enter'  to confirm the parameter selection:



9. press 'Esc'  to go back to the previous page.

4.3.5 'Configuration set parameters' menu

Accessing this menu is possible to show and edit the configuration settings stored in the TU connected to the display.

4.3.5.1 Menu structure

The parameters available are different depending of the TU type connected to the display. In case of use of 'Ekip E-LSIG' TU type the following structure is available:

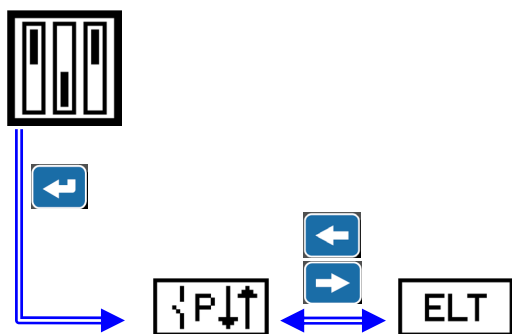

Version	L5048		Apparatus	Ekip Display	Language EN
	L5975				
ABB			Doc. No	1SDH000892R0002	Pag. No 37/54

In case of use of 'Ekip M-LRIU' TU type the following structure is available:

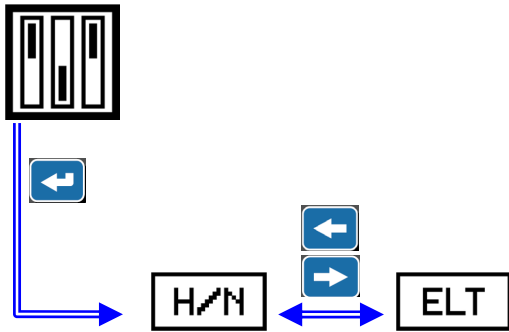

4.3.5.2 Available parameters

In case of use of 'Ekip E-LSIG' TU type the following structure is available:

Symbol	Name	Par.
	Power direction	4.3.5.3
	Protection set	4.3.5.5

In case of use of 'Ekip M-LRIU' TU type the following structure is available:

Symbol	Name	Par.
	Actuator type selection	4.3.5.4
	Protection set	4.3.5.5

4.3.5.3 ‘Power direction’ parameter

Show and edit the setting for power direction of the TU connected to the display.

This parameter is available only for ‘Ekip E-LSIG’ TU type.

Available parameter set are:

Parameter set	Direction
↓	Top → Bottom
↑	Bottom → Top

4.3.5.4 ‘Actuator type selection’ parameter

Show and edit the setting for the actuator type selection of the TU connected to the display.

This parameter is available only for ‘Ekip M-LRIU’ TU type.

Available parameter set are:

Parameter set	Actuator type
Heavy	Trip coil
Normal	Contactora

4.3.5.5 ‘Protection set’ parameter

Show and edit the protection parameters set used by the TU connected to the display.

This parameter is available for ‘Ekip M-LRIU’ and ‘Ekip E-LSIG’ TU type.

It’s possible to choose between ‘Manual’ or ‘Electronic’ protection set.

Version	L5048			Apparatus	Ekip Display	Language	EN
	L5975						
ABB				Doc. No	1SDH000892R0002	Pag. No	39/54

4.4 'Communication' menu

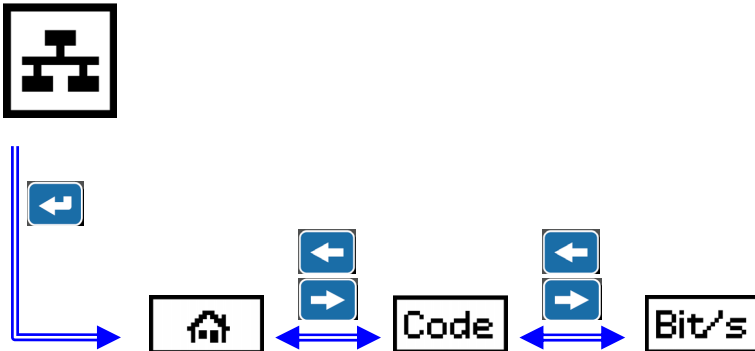

4.4.1 Menu structure



4.4.2 Available parameters

Communication parameters concern the communication with system bus, using Ekip Com unit.

Communication between TU and display is set with fixed parameters.

Symbol	Name	Par.
	Slave address	4.4.3
	Code	4.4.4
	Baudrate	4.4.5

Version	L5048			Apparatus	Ekip Display	Language EN
	L5975					
ABB				Doc. No	1SDH000892R0002	Pag. No 40/54

4.4.3 'Slave address' parameter

Show and edit Modbus address of the TU connected to the display.

It's possible to set any address between 1 and 247.

4.4.4 'Code' parameter

Show and edit Modbus protocol coding parameters of the TU connected to the display.

Available parameters set are:

Parameter set	Parity	Bit number	Stop bit
E,8,1	Even	8	1
O,8,1	Odd	8	1
N,8,2	None	8	2
N,8,1	None	8	1

4.4.5 'Baudrate' parameter

Show and edit the communication speed parameter of the TU connected to the display.

It's possible to set a baudrate equal to 9600 bit/s or 19200 bit/s.

Version	L5048			Apparatus	Ekip Display	Language EN
	L5975					
ABB				Doc. No	1SDH000892R0002	Pag. No 41/54



4.4.6 Communication parameter programming example

1. From default page:



2. press 'Enter'  for access to main menu:



3. move through main menu with 'Right'  and 'Left'  buttons and press 'Enter'  to select 'Communication' menu:



4. press 'Enter'  to select 'Slave address' parameter:



5. using 'Right'  and 'Left'  buttons select the wanted value:



6. press 'Enter'  to confirm the parameter selection:



7. press 'Esc'  to go back to the previous page.

Version	L5048			Apparatus	Ekip Display	Language	EN
	L5975						
ABB				Doc. No	1SDH000892R0002	Pag. No	42/54

4.5 'History' menu

4.5.1 Menu structure

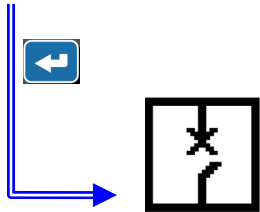

4.5.2 Available submenus

Available submenus			
Symbol	Name	Description	Par.
	Trip history	Show the information about the protective trip made by TU	4.5.3

Version	L5048			Apparatus	Ekip Display	Language	EN
	L5975						
ABB				Doc. No	1SDH000892R0002	Pag. No	43/54

4.5.3 'Trip history' menu

Show the information about all protective trip made by TU.

Available information are:

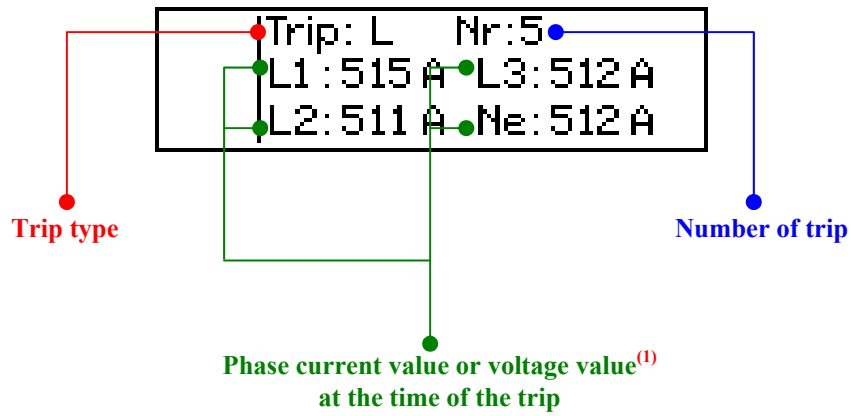

(1) Available for 'Ekip E-LSIG' TU type only

The higher 'Trip number' indicates the last trip occurred.

The trip showed at 'Trip history' menu access is the last trip occurred.

Is possible to scroll the trip using 'Right'  and 'Left'  buttons.



Version	L5048			Apparatus	Ekip Display	Language EN
	L5975					
ABB				Doc. No	1SDH000892R0002	Pag. No 44/54

4.6 'Information' menu

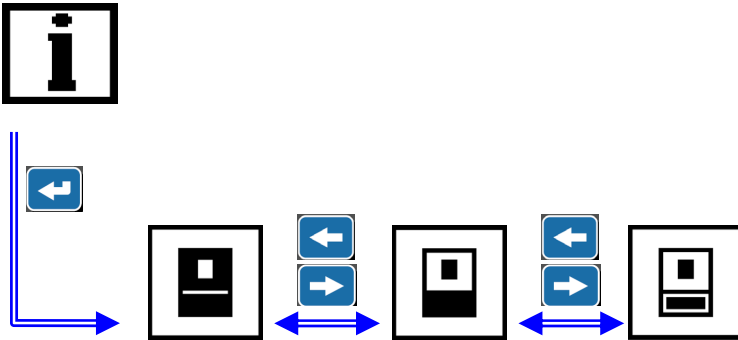
4.6.1 Menu structure



4.6.2 Available submenus

Available submenus			
Symbol	Name	Description	Par.
	CB information	Show configuration information about the CB connected to the TU	4.6.3
	TRIP UNIT information	Show configuration information about the TU connected to the display	4.6.4
	DISPLAY information	Show information about the display	4.6.5

Version	L5048			Apparatus	Ekip Display	Language EN
	L5975					
ABB				Doc. No	1SDH000892R0002	Pag. No 45/54

4.6.3 'CB information' menu

Show the following information about CB:

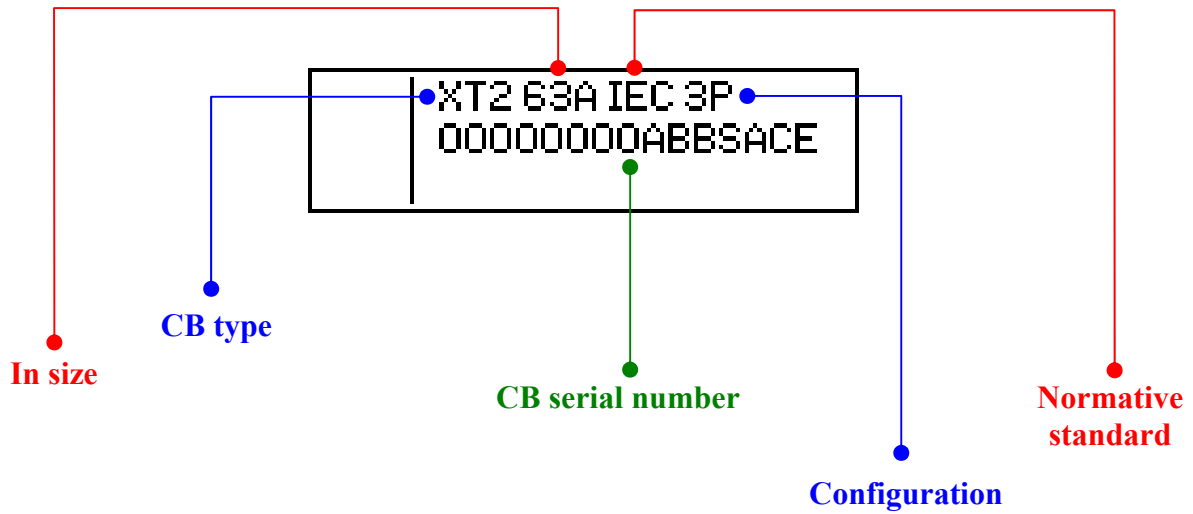

4.6.4 'TRIP UNIT information' menu

Show the following information about TU:

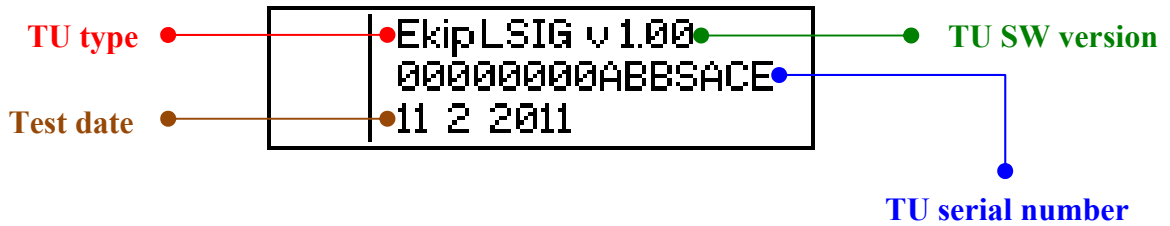

4.6.5 'DISPLAY information' menu

Consente la visualizzazione delle seguenti informazioni relative al display:

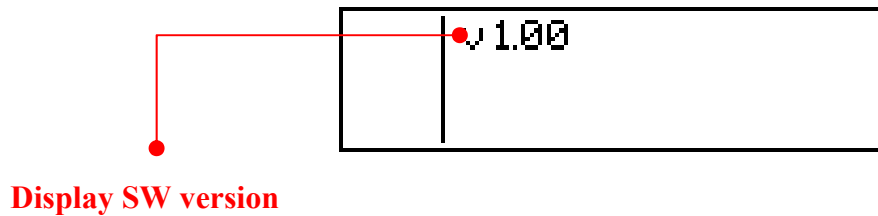

Version	L5048			Apparatus	Ekip Display	Language EN
	L5975					
ABB				Doc. No	1SDH000892R0002	Pag. No 46/54

4.7 'Settings' menu

4.7.1 Menu structure

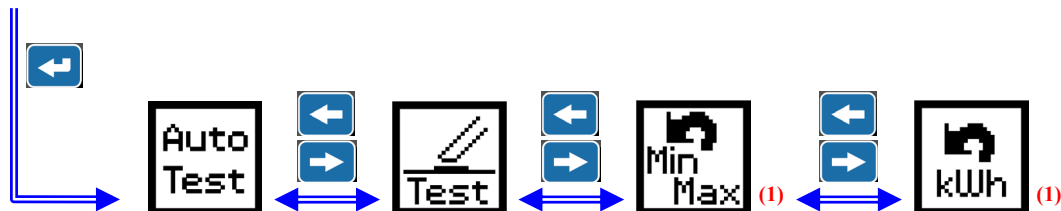

(1) Available for 'Ekip E-LSIG' TU type only

4.7.2 Available submenus

Available submenus			
Symbol	Name	Description	Par.
	Autotest	Display operation verify	4.7.3
	Buttons test	Buttons operation verify	4.7.4
	MIN/MAX reset ⁽¹⁾	Reset the 'minimum/maximum' statistics information of the TU connected to the display	4.7.5
	ENERGY reset ⁽¹⁾	Reset the energy meter information of the TU connected to the display	4.7.6

(1) Available for 'Ekip E-LSIG' TU type only



Version	L5048		Apparatus	Ekip Display	Language EN
	L5975				
ABB			Doc. No	1SDH000892R0002	Pag. No 47/54

4.7.3 'Autotest' menu

Allow to verify proper operation of all pixel of the display.

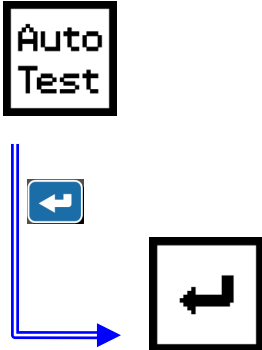
4.7.3.1 Menu structure



Available submenus		
Symbol	Name	Description
	Autotest start	Push 'Enter' button  to perform autotest procedure; the positive result of autotest is highlighted by simultaneously ignition, for 2 times, of all pixel of the display

In case of negative result of autotest, contact ABB SACE customer service.

Version	L5048		Apparatus	Ekip Display	Language EN
	L5975				
ABB			Doc. No	1SDH000892R0002	Pag. No 48/54

4.7.4 'Buttons test' menu

Allow to verify proper operation of all buttons of the display.

The buttons test procedure is composed by 4 sequential steps.

At each step is showed the button that have to be pressed; in case that display correctly identify the pressure of the button, the test continue with the next button.

The buttons pressure order is:



In case of positive result of test, after 'Enter' button  is pressed, display automatically returns at upper menu 'Settings'.

In case of malfunctioning of any button, the button test procedure don't pass over to following step. In this case to return anyway to default page is necessary turn off and afterward turn on the display.

In case of negative result of buttons test, contact ABB SACE customer service.



4.7.5 'MIN/MAX reset' menu

Allow to reset all the 'minimum/maximum' statistical information stored in the TU connected to the display.

This function is available only for 'Ekip E-LSIG' TU type.

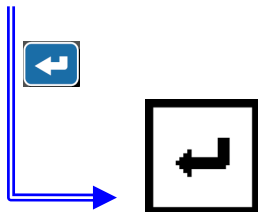
4.7.5.1 Menu structure



Available submenus		
Symbol	Name	Description
	MIN/MAX reset	Push 'Enter' button  to send to the TU a command to reset all the 'minimum/maximum' statistical information of the TU connected to the display

Version	L5048		Apparatus	Ekip Display	Language EN
	L5975				
ABB			Doc. No	1SDH000892R0002	Pag. No 49/54



4.7.6 'ENERGY reset' menu

Allow to reset all the energy measures stored in the TU connected to the display.

This function is available only for 'Ekip E-LSIG' TU type.

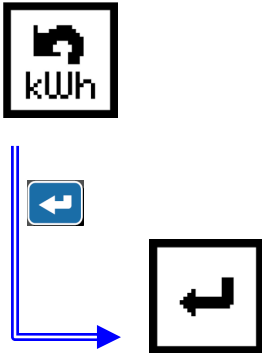
4.7.6.1 Menu structure



Available submenus		
Symbol	Name	Description
	ENERGY reset	Push 'Enter' button  to send to the TU a command to reset all the energy measures of the TU connected to the display

Version	L5048		Apparatus	Ekip Display	Language EN
	L5975				
ABB			Doc. No	1SDH000892R0002	Pag. No 50/54



4.8 'Trip test' menu

Allow to perform an opening operation of the CB through the TU.

Before proceed with the trip test verify that TU and CB are in the conditions indicated in ABB SACE product documentation.

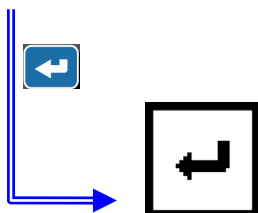
4.8.1 Menu structure



Available submenus		
Symbol	Name	Description
	Trip test start	Push 'Enter' button  to perform the trip test of TU; the positive result of the trip test is highlighted by the opening of CB where TU is installed

In case of negative result of trip test, contact ABB SACE customer service.

Version	L5048		Apparatus	Ekip Display	Language EN
	L5975				
ABB			Doc. No	1SDH000892R0002	Pag. No 51/54

5 Miscellaneous information

5.1 Display features

Characteristic	Description
Type	LCD display 128x32
Backlight timeout time	30 seconds
Operation conditions	With auxiliary power supply presence or with self supply condition
Operation temperature	LCD screen switching on with temperature range included from -25 to +70 °C, tolerance ± 5 °C

5.2 Backlight features

Backlight status	Conditions
High intensity	Auxiliary power supply presence NO default page
	NO auxiliary power supply Self supply condition with $\Sigma I > 1I_n$ NO default page
Low intensity	Auxiliary power supply presence Default page
	NO auxiliary power supply Self supply condition with $\Sigma I > 1I_n$ Default page
	NO auxiliary power supply Self supply condition with $0.35I_n < \Sigma I < 1I_n$
Off	NO auxiliary power supply Self supply condition with $\Sigma I < 0.35I_n$
Blinking	Alarm condition

Version	L5048			Apparatus	Ekip Display	Language EN
	L5975					
ABB				Doc. No	1SDH000892R0002	Pag. No 52/54

5.3 'Power' led features

'Power' led state	Description
On	'Power mode' TU configuration
Blinking with $f = 2\text{Hz}$	'Wink' command sent to TU
Blinking with $f = 0,5\text{Hz}$	'Alive mode' TU configuration

5.4 Ekip TT or Ekip T&P unit connection

When connected, Ekip T&P communication mode is activated by default:



It's possible to change the operation mode; press any key to make available following submenus:

Available submenus			
Symbol	Name	Description	Par.
	Ekip TT connection	Allow to use Ekip TT test unit keeping the navigation through menus active	5.4.1
	Ekip T&P connection	Allow to use Ekip T&P communication unit preventing the navigation through menus	

In case of use with Ekip TT, if 'Trip test' button is pressed, the trip test of TU is performed and display returns to default conditions.

Version	L5048		Apparatus	Ekip Display	Language EN
	L5975				
ABB			Doc. No	1SDH000892R0002	Pag. No 53/54

5.4.1 Ekip TT or Ekip T&P connection procedure

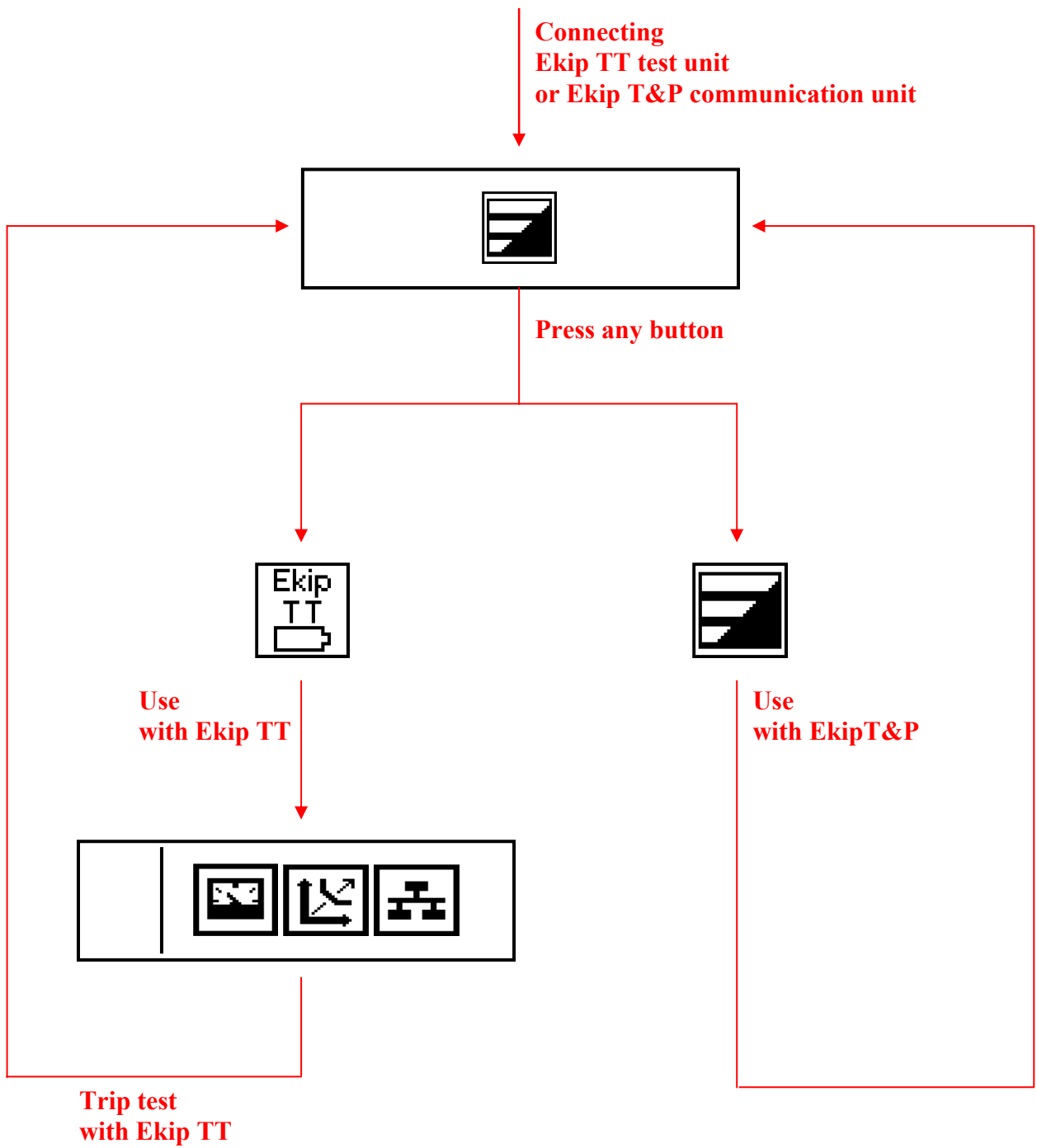

Version	L5048			Apparatus	Ekip Display	Language EN
	L5975					
ABB				Doc. No	1SDH000892R0002	Pag. No 54/54