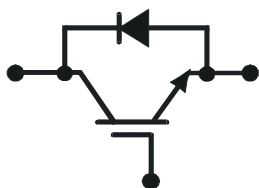


$V_{CE} = 1700\text{ V}$

$I_C = 1800\text{ A}$

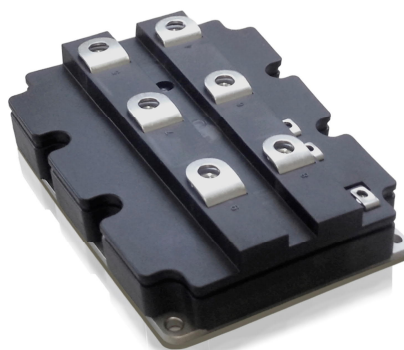
# HiPak



## IGBT Module 5SNA 1800E170100

Doc. No. 5SYA 1554-04 10-2020

- Low-loss, rugged SPT chip-set
- Smooth switching SPT chip-set for good EMC
- Industry standard package
- High power density
- AlSiC base-plate for high power cycling capability
- AlN substrate for low thermal resistance
- Improved high reliability package
- Recognized under UL1557, File E196689



### Maximum rated values <sup>1)</sup>

Parameter	Symbol	Conditions	min	max	Unit
Collector-emitter voltage	$V_{CES}$	$V_{GE} = 0\text{ V}$ , $T_{vj} \geq 25\text{ °C}$		1700	V
DC collector current	$I_C$	$T_c = 80\text{ °C}$		1800	A
Peak collector current	$I_{CM}$	$t_p = 1\text{ ms}$ , $T_c = 80\text{ °C}$		3600	A
Gate-emitter voltage	$V_{GES}$		-20	20	V
Total power dissipation	$P_{tot}$	$T_c = 25\text{ °C}$ , per switch (IGBT)		11000	W
DC forward current	$I_F$			1800	A
Peak forward current	$I_{FRM}$			3600	A
Surge current	$I_{FSM}$	$V_R = 0\text{ V}$ , $T_{vj} = 125\text{ °C}$ , $t_p = 10\text{ ms}$ , half-sinewave		16500	A
IGBT short circuit SOA	$t_{psc}$	$V_{CC} = 1200\text{ V}$ , $V_{CEMCHIP} \leq 1700\text{ V}$ $V_{GE} \leq 15\text{ V}$ , $T_{vj} \leq 125\text{ °C}$		10	$\mu\text{s}$
Isolation voltage	$V_{isol}$	1 min, $f = 50\text{ Hz}$		4000	V
Junction temperature	$T_{vj}$			150	$^{\circ}\text{C}$
Junction operating temperature	$T_{vj(op)}$		-50	125	$^{\circ}\text{C}$
Case temperature	$T_c$		-50	125	$^{\circ}\text{C}$
Storage temperature	$T_{stg}$		-50	125	$^{\circ}\text{C}$
Mounting torques <sup>2)</sup>	$M_1$	Base-heatsink, M6 screws	4	6	Nm
	$M_2$	Main terminals, M8 screws	8	10	
	$M_3$	Auxiliary terminals, M4 screws	2	3	

<sup>1)</sup> Maximum rated values indicate limits beyond which damage to the device may occur per IEC 60747

<sup>2)</sup> For detailed mounting instructions refer to Document No. 5SYA2039

IGBT characteristic values <sup>3)</sup>

Parameter	Symbol	Conditions	min	typ	max	Unit	
Collector (-emitter) breakdown voltage	$V_{(BR)CES}$	$V_{GE} = 0 \text{ V}$ , $I_C = 10 \text{ mA}$ , $T_{vj} = 25 \text{ }^\circ\text{C}$	1700			V	
Collector-emitter <sup>4)</sup> saturation voltage	$V_{CE \text{ sat}}$	$I_C = 1800 \text{ A}$ , $V_{GE} = 15 \text{ V}$	$T_{vj} = 25 \text{ }^\circ\text{C}$	2.0	2.3	2.6	V
			$T_{vj} = 125 \text{ }^\circ\text{C}$	2.3	2.6	2.9	V
Collector cut-off current	$I_{CES}$	$V_{CE} = 1700 \text{ V}$ , $V_{GE} = 0 \text{ V}$	$T_{vj} = 25 \text{ }^\circ\text{C}$			12	mA
			$T_{vj} = 125 \text{ }^\circ\text{C}$		50	120	mA
Gate leakage current	$I_{GES}$	$V_{CE} = 0 \text{ V}$ , $V_{GE} = \pm 20 \text{ V}$ , $T_{vj} = 125 \text{ }^\circ\text{C}$	-500		500	nA	
Gate-emitter threshold voltage	$V_{GE(TO)}$	$I_C = 240 \text{ mA}$ , $V_{CE} = V_{GE}$ , $T_{vj} = 25 \text{ }^\circ\text{C}$	4.5		6.5	V	
Gate charge	$Q_{ge}$	$I_C = 1800 \text{ A}$ , $V_{CE} = 900 \text{ V}$ , $V_{GE} = -15 \text{ V} .. 15 \text{ V}$		15.1		$\mu\text{C}$	
Input capacitance	$C_{ies}$	$V_{CE} = 25 \text{ V}$ , $V_{GE} = 0 \text{ V}$ , $f = 1 \text{ MHz}$ , $T_{vj} = 25 \text{ }^\circ\text{C}$		166		nF	
Output capacitance	$C_{oes}$			16.5			
Reverse transfer capacitance	$C_{res}$			6.98			
Turn-on delay time	$t_{d(on)}$	$V_{CC} = 900 \text{ V}$ , $I_C = 1800 \text{ A}$ , $R_G = 0.82 \text{ } \Omega$ ,	$T_{vj} = 25 \text{ }^\circ\text{C}$	290		ns	
			$T_{vj} = 125 \text{ }^\circ\text{C}$	300			
Rise time	$t_r$	$V_{GE} = \pm 15 \text{ V}$ , $L_\sigma = 60 \text{ nH}$ , inductive load	$T_{vj} = 25 \text{ }^\circ\text{C}$	230		ns	
			$T_{vj} = 125 \text{ }^\circ\text{C}$	250			
Turn-off delay time	$t_{d(off)}$	$V_{CC} = 900 \text{ V}$ , $I_C = 1800 \text{ A}$ , $R_G = 0.82 \text{ } \Omega$ ,	$T_{vj} = 25 \text{ }^\circ\text{C}$	920		ns	
			$T_{vj} = 125 \text{ }^\circ\text{C}$	1000			
Fall time	$t_f$	$V_{GE} = \pm 15 \text{ V}$ , $L_\sigma = 60 \text{ nH}$ , inductive load	$T_{vj} = 25 \text{ }^\circ\text{C}$	215		ns	
			$T_{vj} = 125 \text{ }^\circ\text{C}$	230			
Turn-on switching energy	$E_{on}$	$V_{CC} = 900 \text{ V}$ , $I_C = 1800 \text{ A}$ , $V_{GE} = \pm 15 \text{ V}$ , $R_G = 0.82 \text{ } \Omega$ , $L_\sigma = 60 \text{ nH}$ , inductive load	$T_{vj} = 25 \text{ }^\circ\text{C}$	380		mJ	
			$T_{vj} = 125 \text{ }^\circ\text{C}$	550			
Turn-off switching energy	$E_{off}$	$V_{CC} = 900 \text{ V}$ , $I_C = 1800 \text{ A}$ , $V_{GE} = \pm 15 \text{ V}$ , $R_G = 0.82 \text{ } \Omega$ , $L_\sigma = 60 \text{ nH}$ , inductive load	$T_{vj} = 25 \text{ }^\circ\text{C}$	560		mJ	
			$T_{vj} = 125 \text{ }^\circ\text{C}$	700			
Short circuit current	$I_{SC}$	$t_{psc} \leq 10 \text{ } \mu\text{s}$ , $V_{GE} = 15 \text{ V}$ , $T_{vj} = 125 \text{ }^\circ\text{C}$ , $V_{CC} = 1200 \text{ V}$ , $V_{CEM \text{ CHIP}} \leq 1700 \text{ V}$		8500		A	
Module stray inductance	$L_{\sigma \text{ CE}}$			10		nH	
Resistance, terminal-chip	$R_{CC'+EE'}$		$T_C = 25 \text{ }^\circ\text{C}$	0.06		m $\Omega$	
			$T_C = 125 \text{ }^\circ\text{C}$	0.085			

<sup>3)</sup> Characteristic values according to IEC 60747 – 9<sup>4)</sup> Collector-emitter saturation voltage is given at chip level

**Diode characteristic values** <sup>5)</sup>

Parameter	Symbol	Conditions	min	typ	max	Unit	
Forward voltage <sup>6)</sup>	$V_F$	$I_F = 1800 \text{ A}$	$T_{vj} = 25 \text{ °C}$	1.4	1.65	2.0	V
			$T_{vj} = 125 \text{ °C}$	1.4	1.7	2.0	
Reverse recovery current	$I_{rr}$	$V_{CC} = 900 \text{ V},$ $I_F = 1800 \text{ A},$ $V_{GE} = \pm 15 \text{ V},$ $R_G = 0.82 \text{ } \Omega$ $L_\sigma = 60 \text{ nH}$ inductive load	$T_{vj} = 25 \text{ °C}$		1140		A
			$T_{vj} = 125 \text{ °C}$		1460		
Recovered charge	$Q_{rr}$	$V_{CC} = 900 \text{ V},$ $I_F = 1800 \text{ A},$ $V_{GE} = \pm 15 \text{ V},$ $R_G = 0.82 \text{ } \Omega$ $L_\sigma = 60 \text{ nH}$ inductive load	$T_{vj} = 25 \text{ °C}$		440		$\mu\text{C}$
			$T_{vj} = 125 \text{ °C}$		780		
Reverse recovery time	$t_{rr}$	$V_{CC} = 900 \text{ V},$ $I_F = 1800 \text{ A},$ $V_{GE} = \pm 15 \text{ V},$ $R_G = 0.82 \text{ } \Omega$ $L_\sigma = 60 \text{ nH}$ inductive load	$T_{vj} = 25 \text{ °C}$		590		ns
			$T_{vj} = 125 \text{ °C}$		890		
Reverse recovery energy	$E_{rec}$	$V_{CC} = 900 \text{ V},$ $I_F = 1800 \text{ A},$ $V_{GE} = \pm 15 \text{ V},$ $R_G = 0.82 \text{ } \Omega$ $L_\sigma = 60 \text{ nH}$ inductive load	$T_{vj} = 25 \text{ °C}$		310		mJ
			$T_{vj} = 125 \text{ °C}$		540		

<sup>5)</sup> Characteristic values according to IEC 60747 – 2

<sup>6)</sup> Forward voltage is given at chip level

**Thermal properties**

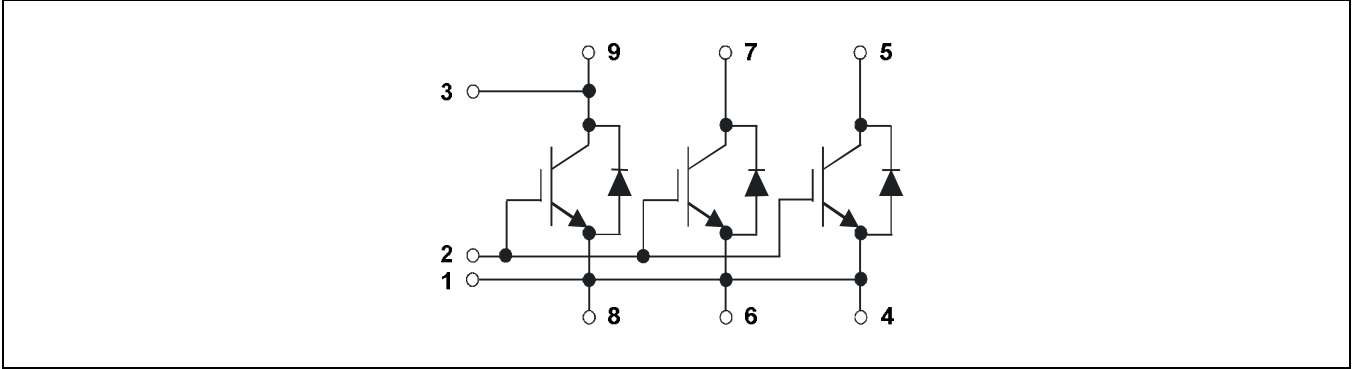
Parameter	Symbol	Conditions	min	typ	max	Unit
IGBT thermal resistance junction to case	$R_{th(j-c)IGBT}$				0.009	K/W
Diode thermal resistance junction to case	$R_{th(j-c)DIODE}$				0.017	K/W
Thermal resistance case <sup>2)</sup> to heatsink	$R_{th(c-h)}$	per module, $\lambda$ grease = $1\text{W/m} \times \text{K}$		0.006		K/W

<sup>2)</sup> For detailed mounting instructions refer to ABB Document No. 5SYA2039

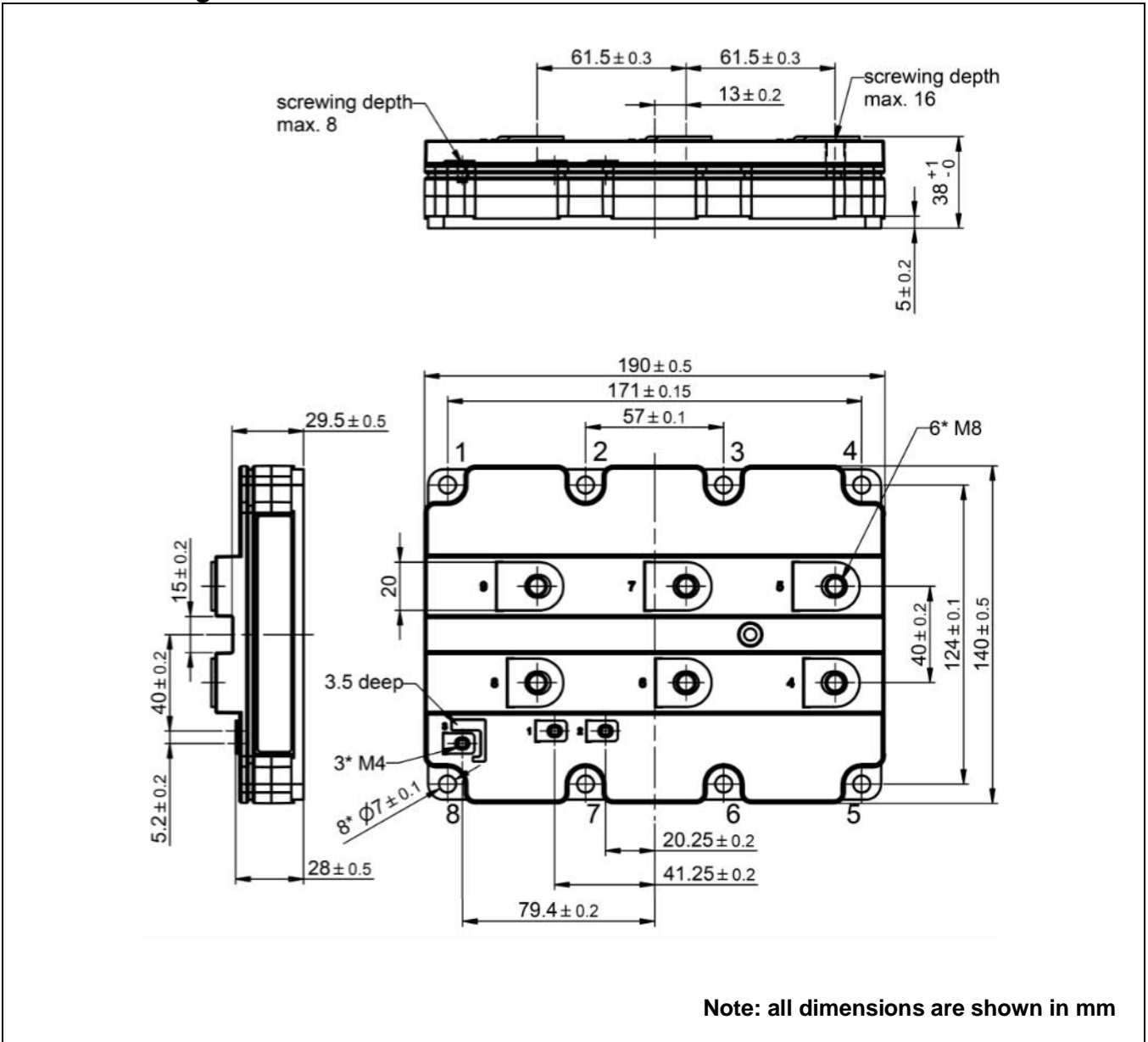
**Mechanical properties**

Parameter	Symbol	Conditions	min	typ	max	Unit
Dimensions	$L \times W \times H$	Typical , see outline drawing	190 × 140 × 38			mm
Comparative tracking index	CTI		600			
Clearance distance	$D_c$	according to IEC 60664-1 and EN 50124-1	Term. to base:	23		mm
			Term. to term:	19		
Surface creepage distance	$D_{sc}$	according to IEC 60664-1 and EN 50124-1	Term. to base:	28.2		mm
			Term. to term:	28.2		
Weight				1210		g

**Electrical configuration**



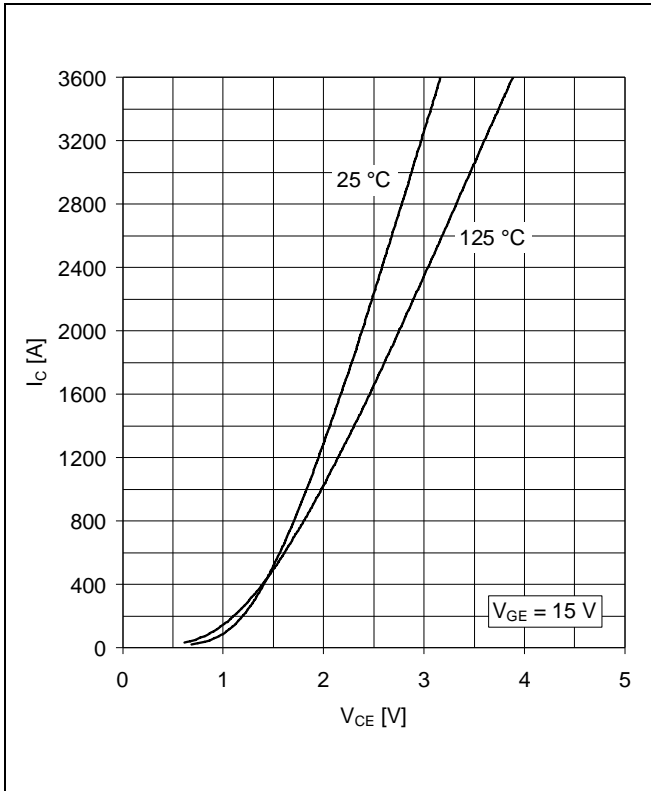
**Outline drawing <sup>2)</sup>**



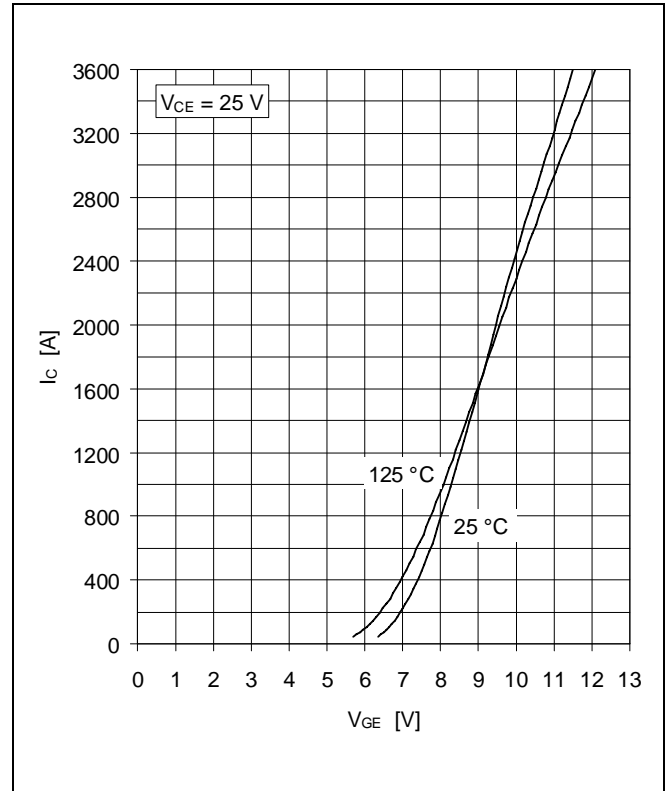
<sup>2)</sup> For detailed mounting instructions refer to Document No. 5SYA2039

**This is an electrostatic sensitive device, please observe the international standard IEC 60747-1, chap. IX.**

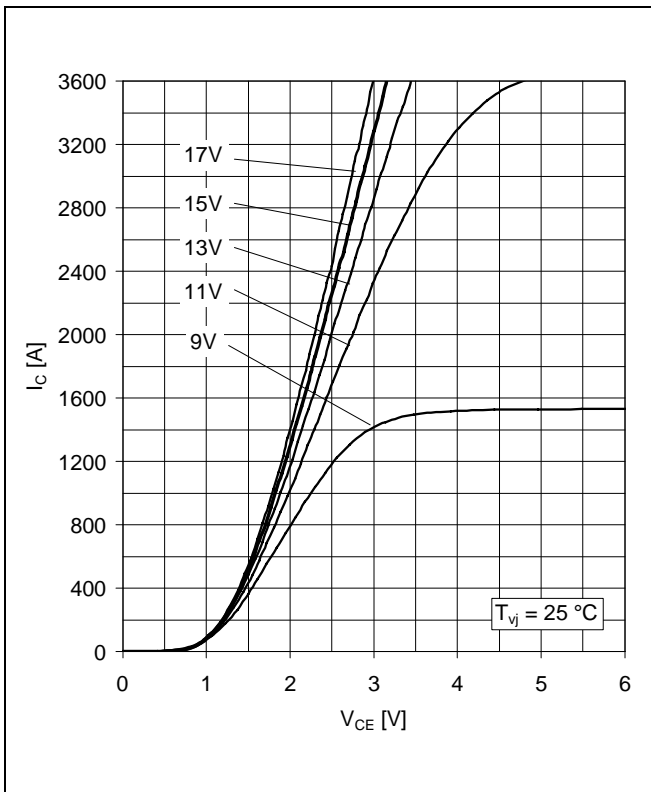
**This product has been designed and qualified for Industrial Level.**



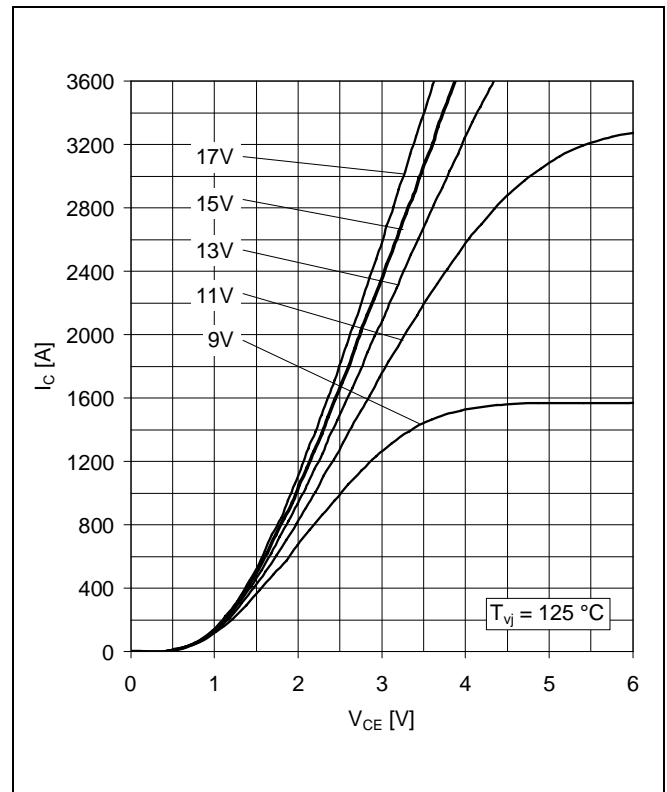
**Fig. 1** Typical on-state characteristics, chip level



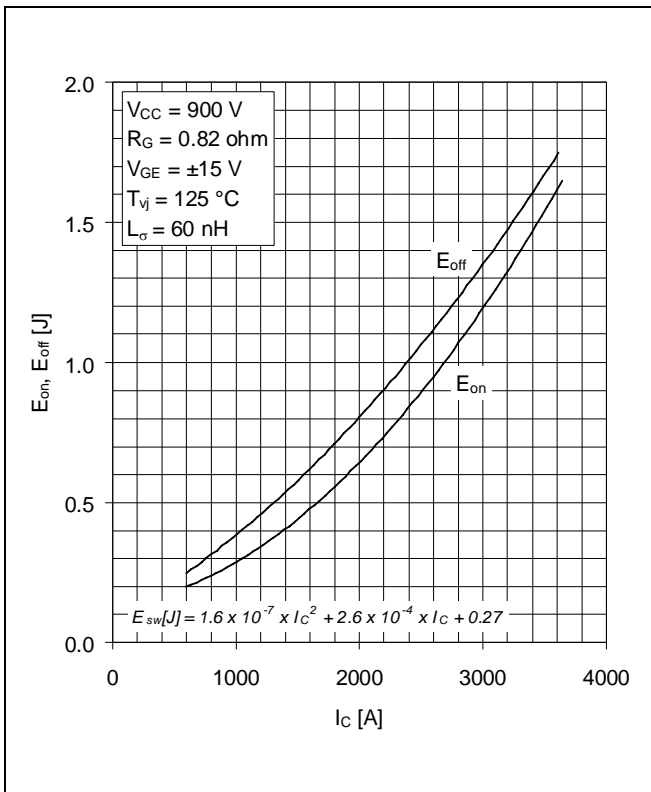
**Fig. 2** Typical transfer characteristics, chip level



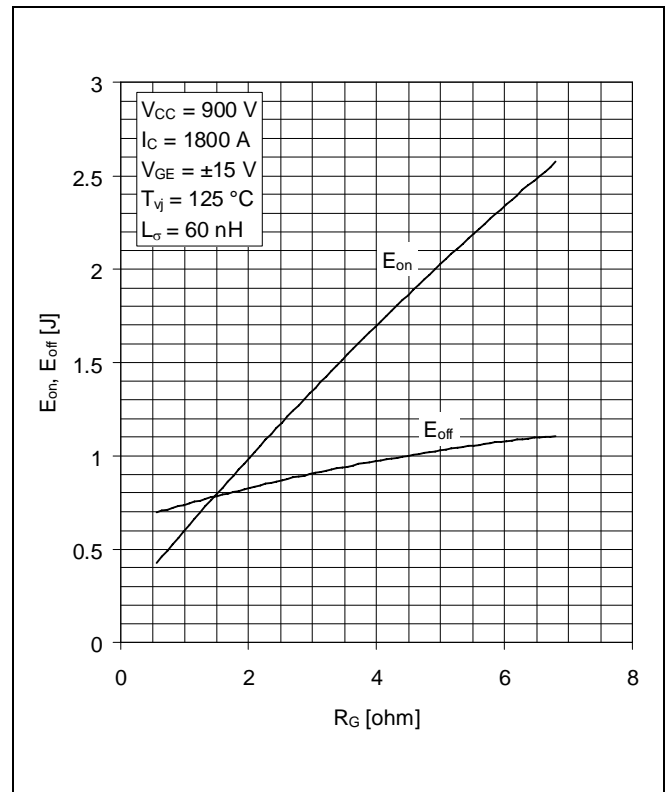
**Fig. 3** Typical output characteristics, chip level



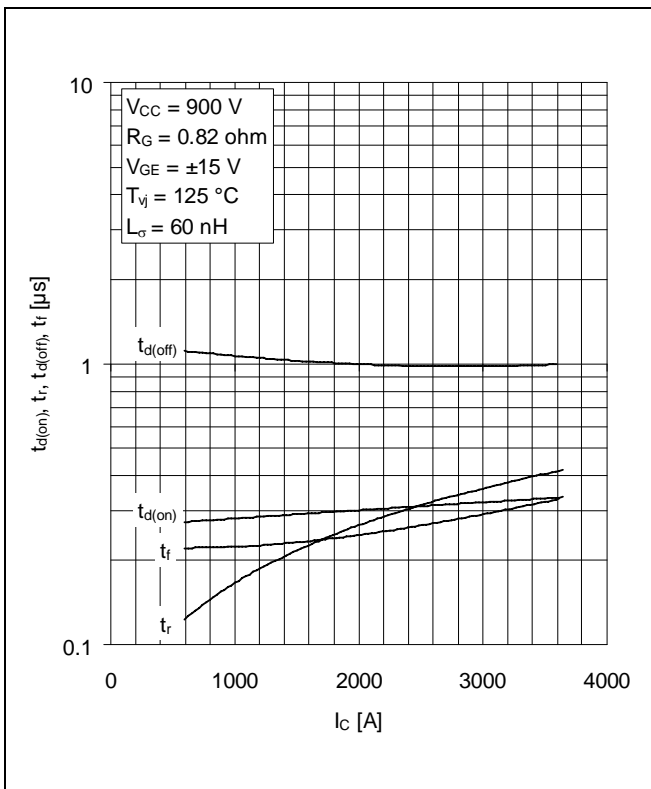
**Fig. 4** Typical output characteristics, chip level



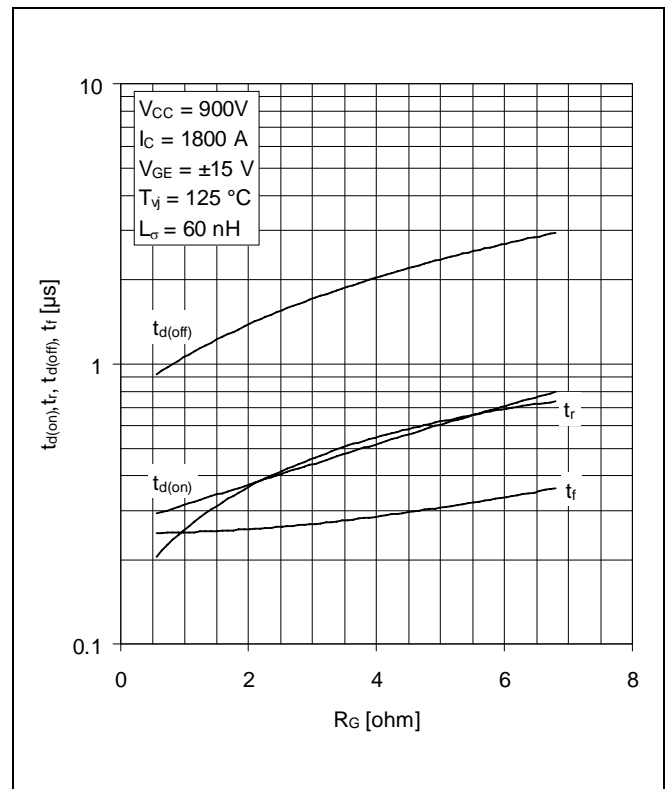
**Fig. 5** Typical switching energies per pulse vs collector current



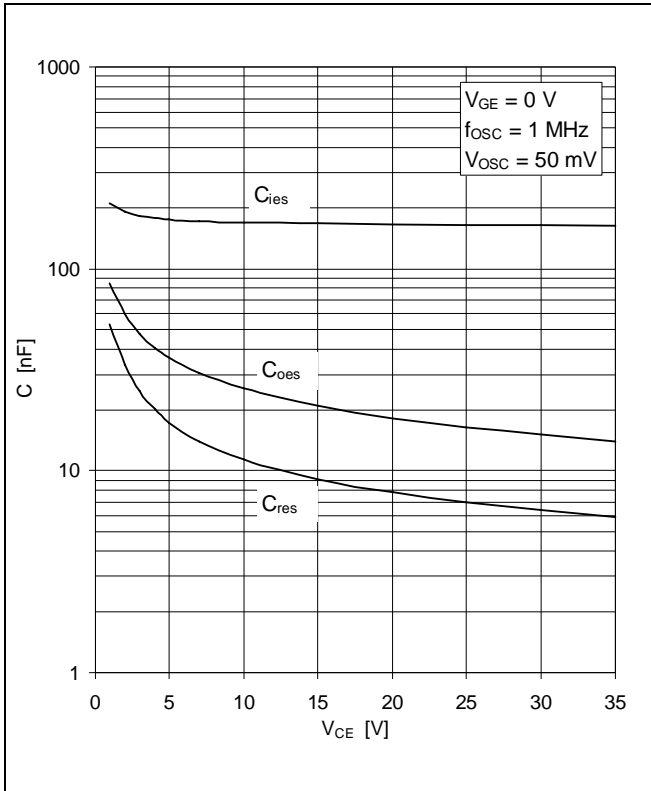
**Fig. 6** Typical switching energies per pulse vs gate resistor



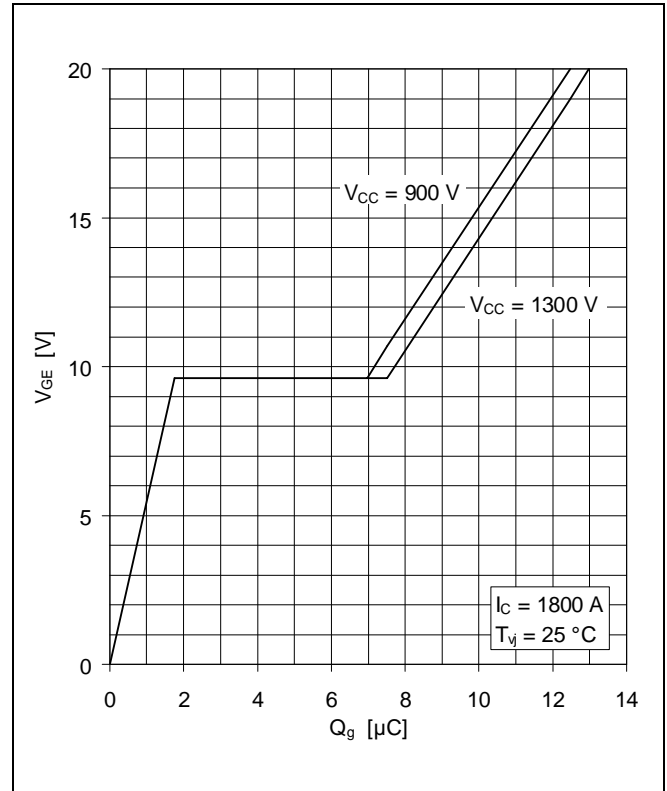
**Fig. 7** Typical switching times vs collector current



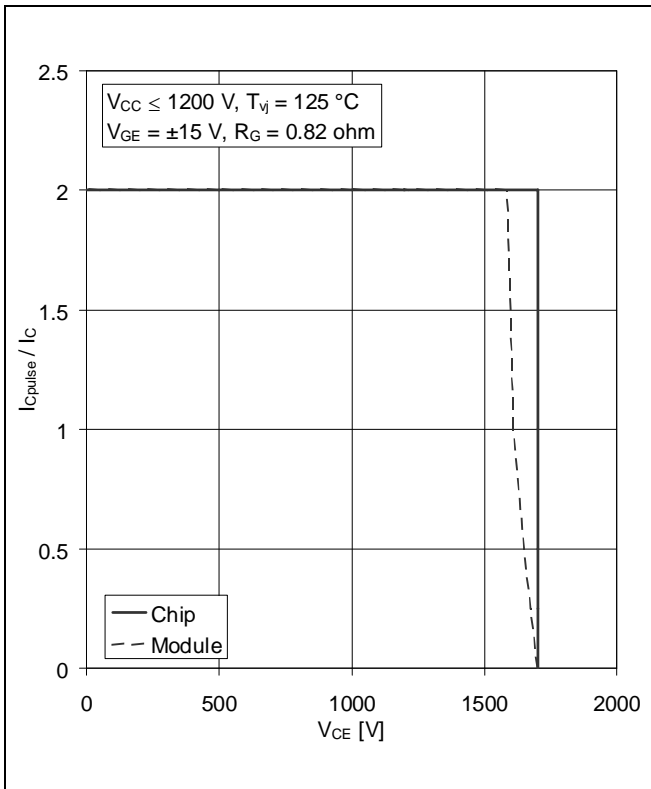
**Fig. 8** Typical switching times vs gate resistor



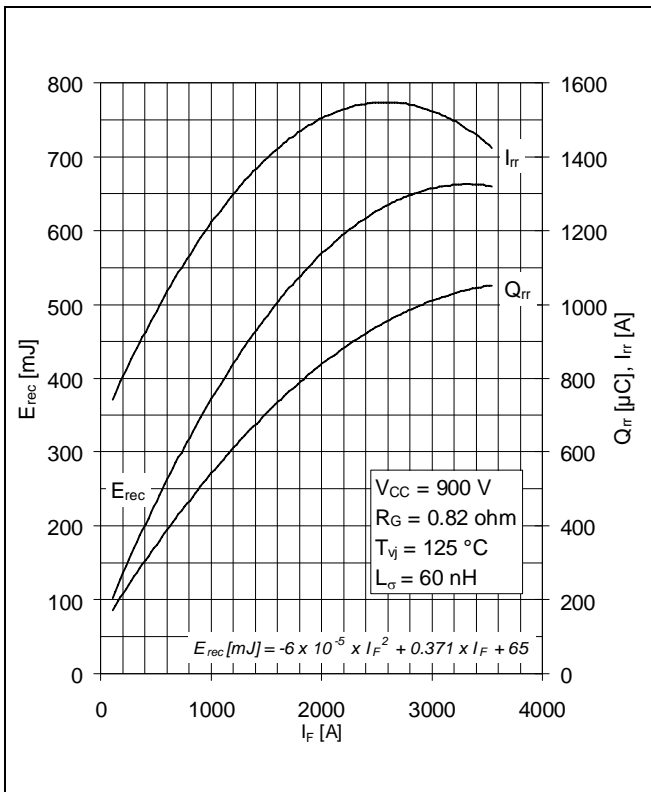
**Fig. 9** Typical capacitances vs collector-emitter voltage



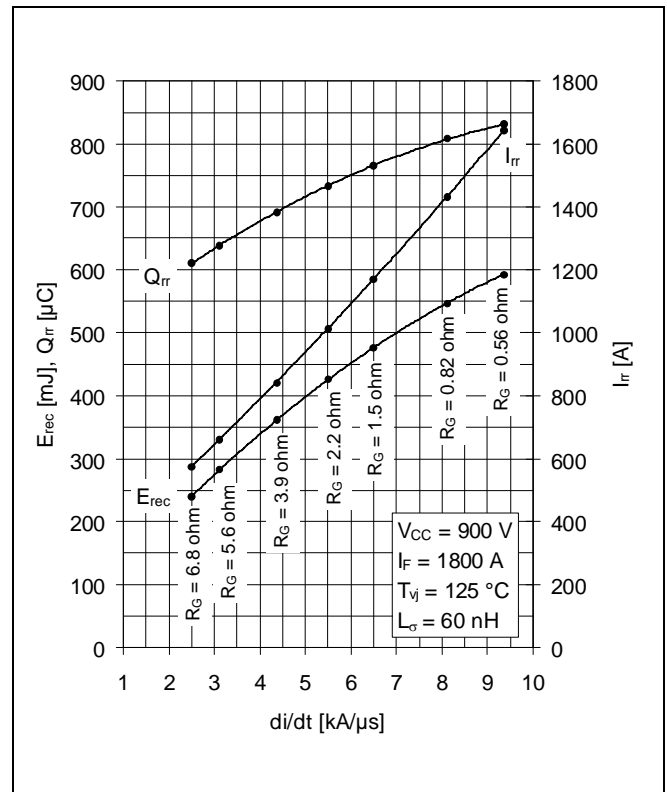
**Fig. 10** Typical gate charge characteristics



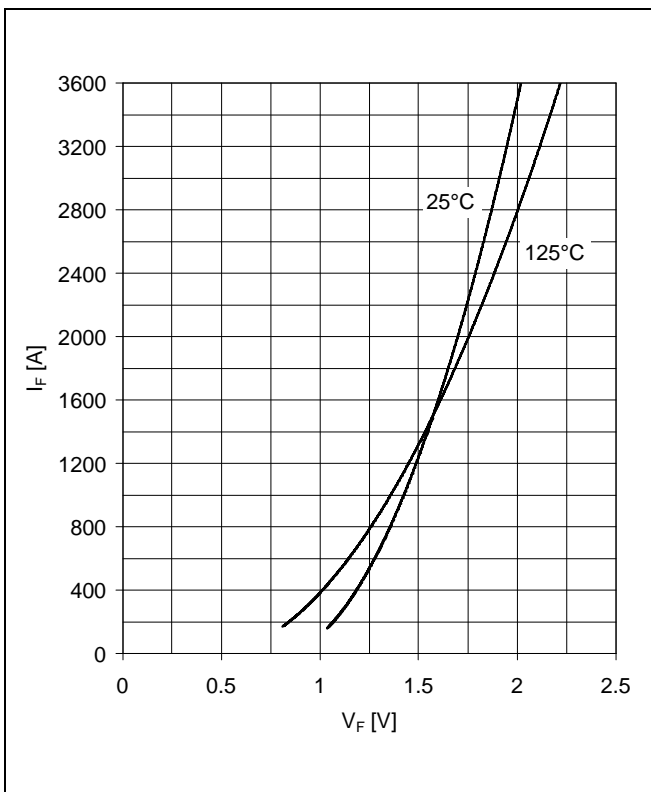
**Fig. 11** Turn-off safe operating area (RBSOA)



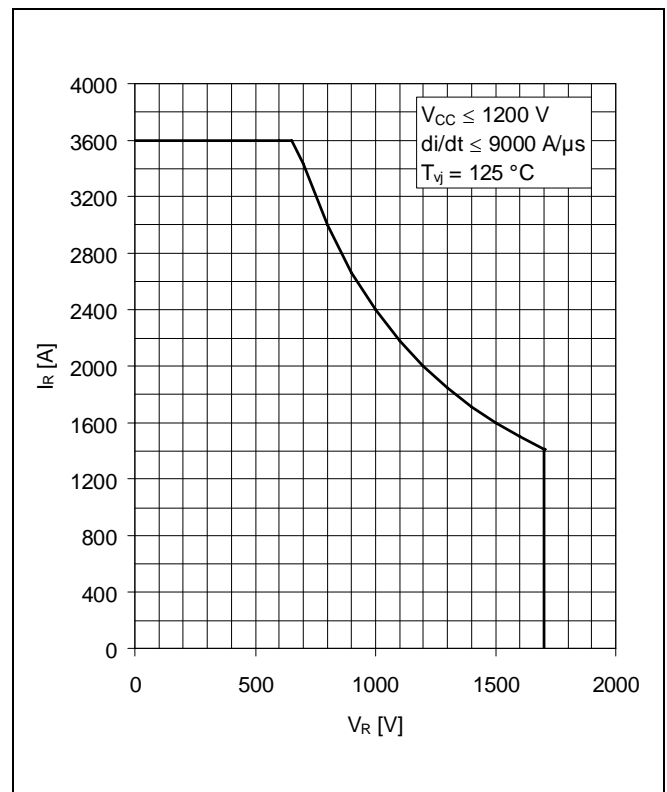
**Fig. 12** Typical reverse recovery characteristics vs forward current



**Fig. 13** Typical reverse recovery characteristics vs di/dt

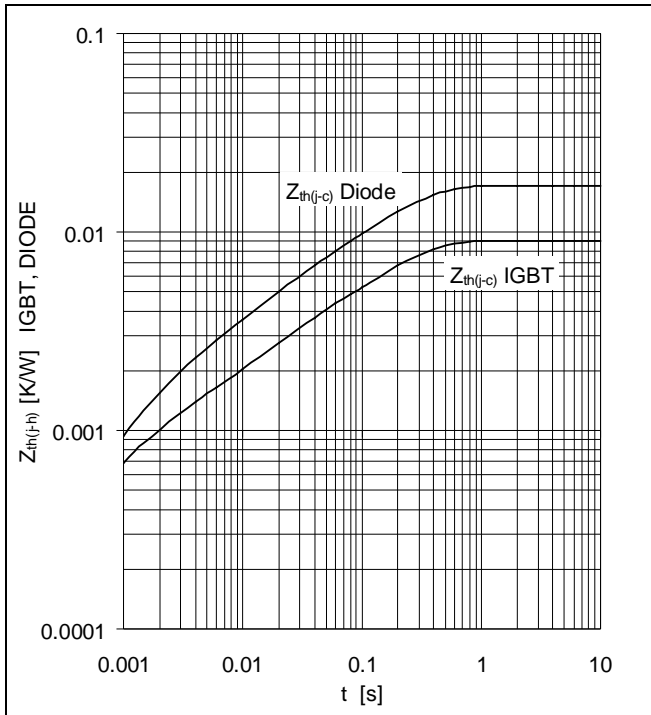


**Fig. 14** Typical diode forward characteristics, chip level



**Fig. 15** Safe operating area diode (SOA)





**Fig. 16** Thermal impedance vs time

**Analytical function for transient thermal impedance:**

$$Z_{th(j-c)}(t) = \sum_{i=1}^n R_i (1 - e^{-t/\tau_i})$$

	i	1	2	3	4	5
IGBT	R <sub>i</sub> (K/kW)	6.24	1.73	0.704	0.345	
	τ <sub>i</sub> (ms)	192	20.4	1.97	0.52	
DIODE	R <sub>i</sub> (K/kW)	11.6	2.91	1.28	1.27	
	τ <sub>i</sub> (ms)	204	29.3	6.96	1.5	

**Related documents:**

- 5SYA 2042 Failure rates of HiPak modules due to cosmic rays
- 5SYA 2043 Load – cycle capability of HiPaks
- 5SYA 2045 Thermal runaway during blocking
- 5SYA 2053 Applying IGBT
- 5SYA 2058 Surge currents for IGBT diodes
- 5SYA 2093 Thermal design of IGBT modules
- 5SYA 2098 Paralleling of IGBT modules
- 5SZK 9111 Specification of environmental class for HiPak Storage
- 5SZK 9112 Specification of environmental class for HiPak Transportation
- 5SZK 9113 Specification of environmental class for HiPak Operation (Industry)
- 5SZK 9120 Specification of environmental class for HiPak

We reserve all rights in this document and in the subject matter and illustrations contained therein. Any reproduction, disclosure to third parties or utilization of its contents – in whole or in parts – is forbidden without prior written consent. Copyright 2020 Hitachi Powergrids. All rights reserved.