

Purpose and function

This system is designed for WC facilities for people with reduced mobility and others in need of assistance. In addition, the system has a light panel that can centrally detect alerts

When the alarm button is pressed or the pullcord is pulled, the indicator light outside the WC facilities will blink and the buzzer will sound intermittently. The indicator light can detect which WC the alert is coming from and it has a buzzer that can be reset with the button. The alert remains in effect until it is reset with the button beside the WC door.

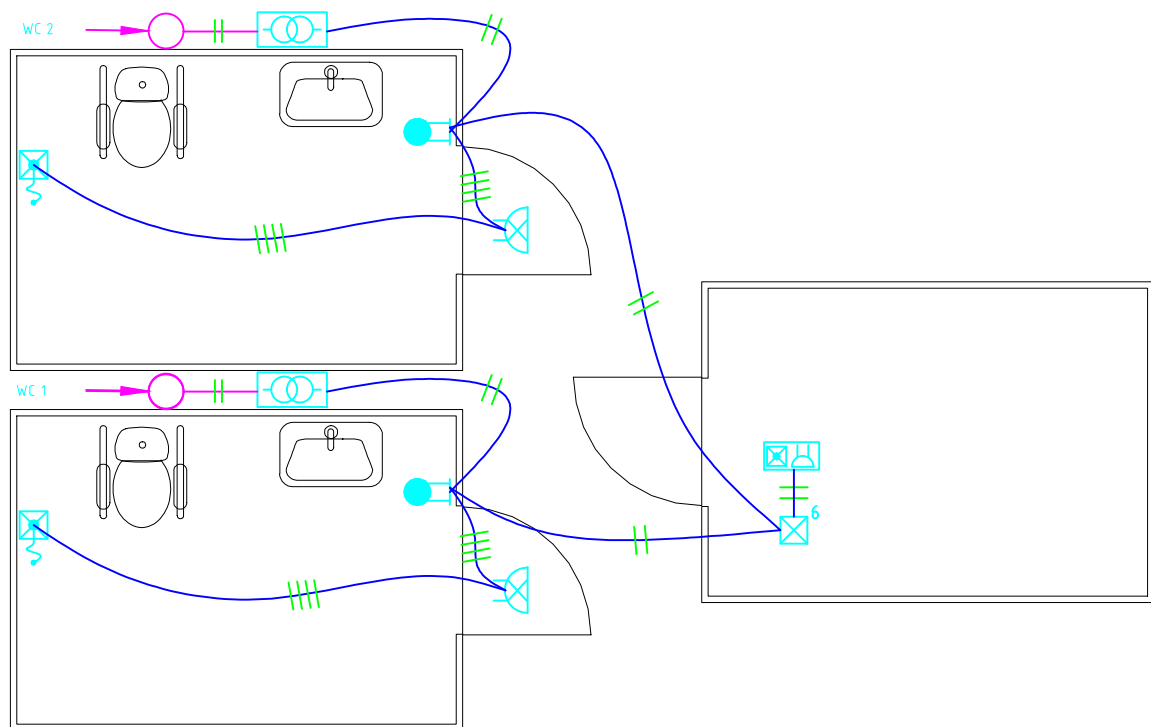













		Pullcord button FAP3002 EAN: 6410070607261	- The cord should be left long enough to touch the floor
		Alarm FIM1200 EAN: 6410070607520	- Installation above the WC door on the outside
		Control unit FEH1001 EAN: 6410070607117	- Control unit with reset button
		Transformer 230V / 15V / 2VA FLM1000 EAN: 6410070607650	- Transformer always installed in its own mounting box - Double protective insulation between the primary and secondary coils is ensured by a insulation tube
		Button / buzzer FIP1011 EAN: 6438199005225	- Buzzer with push button
		Indicator light panel FIM1300 EAN: 6410070607537	- Six indicator lights

ABB Oy
Porvoon Sisäkehä 2, P.O.Box 16
06101 Porvoo, Finland
Tel. +358 10 22 11
www.installationmaterials.com

ABB

Accessible toilet alarm (FEH1001) with follow-up alarm

Special features of the system:

- The system is equipped with a signaling panel which shows centralized alerts



ABB Oy
Porvoon Sisäkehä 2, P.O.Box 16
06101 Porvoo, Finland
Tel. +358 10 22 11
www.installationmaterials.com



Accessible toilet alarm (FEH1001) with follow-up alarm

Special features of the system:

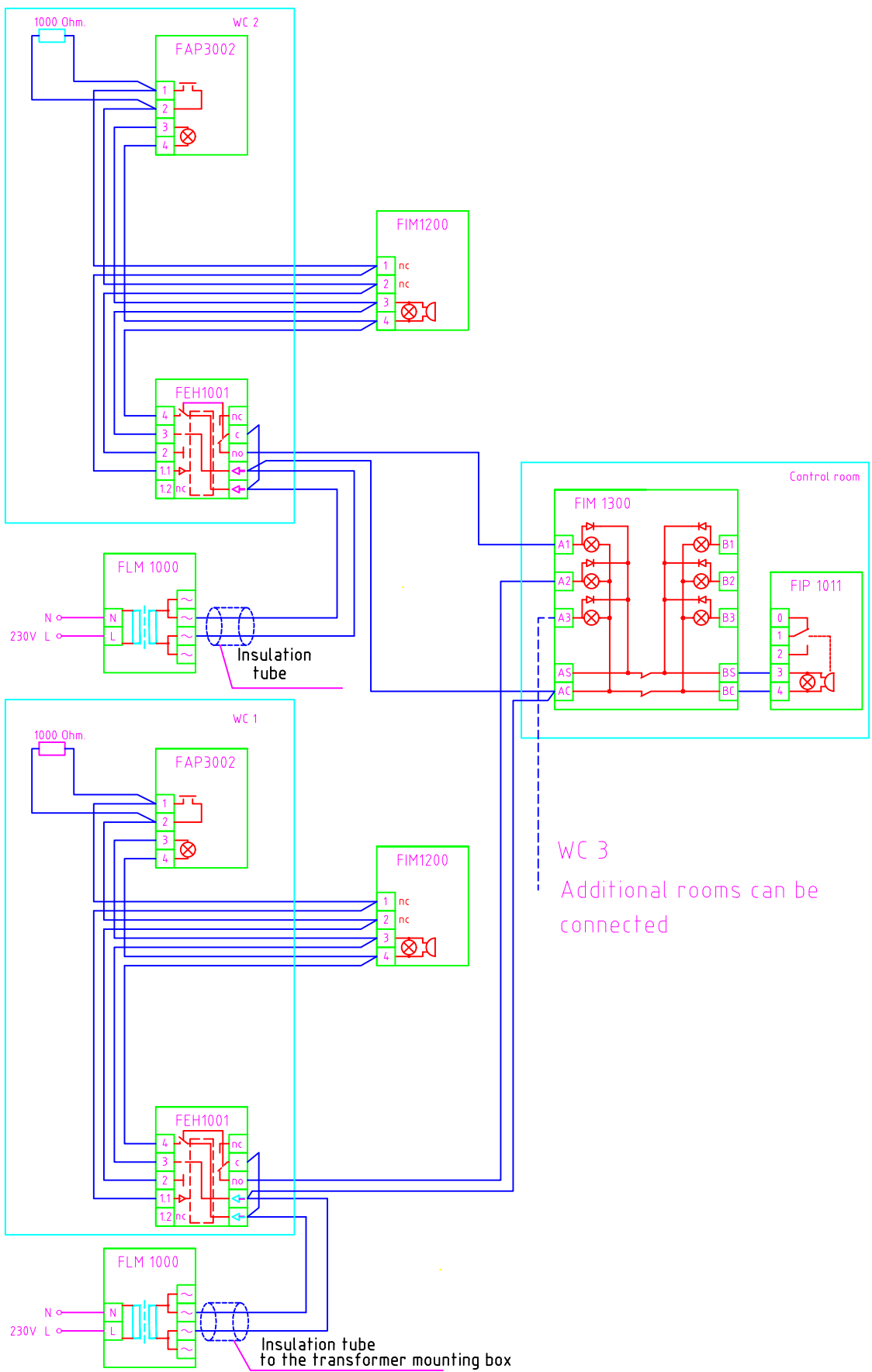
- The system is equipped with a signaling panel which shows centralized alerts