

Original instructions

MKey8-series

Safety Interlock Switch with Guard Locking



Read and understand this document

Please read and understand this document before using the products. Please consult your ABB JOKAB SAFETY representative if you have any questions or comments.

WARRANTY

ABB JOKAB SAFETY's exclusive warranty is that the products are free from defects in materials and workmanship for a period of one year (or other period if specified) from date of sale by ABB JOKAB SAFETY.

ABB JOKAB SAFETY MAKES NO WARRANTY OR REPRESENTATION, EXPRESSED OR IMPLIED, REGARDING NON-INFRINGEMENT, MERCHANTABILITY, OR FITNESS FOR PARTICULAR PURPOSE OF THE PRODUCTS, ANY BUYER OR USER ACKNOWLEDGES THAT THE BUYER OR USER ALONE HAS DETERMINED THAT THE PRODUCTS WILL SUITABLY MEET THE REQUIREMENTS OR THEIR INTENDED USE. ABB JOKAB SAFETY DISCLAIMS ALL OTHER WARRANTIES, EXPRESSED OR IMPLIED.

LIMITATIONS OF LIABILITY

ABB JOKAB SAFETY SHALL NOT BE RESPONSIBLE FOR SPECIAL, INDIRECT, OR CONSEQUENTIAL DAMAGES, LOSS OF PROFITS OR COMMERCIAL LOSS IN ANY WAY CONNECTED WITH THE PRODUCTS, WHETHER SUCH CLAIM IS BASED ON CONTRACT, WARRANTY, NEGLIGENCE, OR STRICT LIABILITY.

In no event shall responsibility of ABB JOKAB SAFETY for any act exceed the individual price of the product on which liability asserted.

IN NO EVENT SHALL ABB JOKAB SAFETY BE RESPONSIBLE FOR WARRANTY, REPAIR, OR OTHER CLAIMS REGARDING THE PRODUCTS UNLESS ABB JOKAB SAFETY'S ANALYSIS CONFIRMS THAT THE PRODUCTS WERE PROPERLY HANDLED, STORED, INSTALLED, AND MAINTAINED AND NOT SUBJECT TO ABUSE, MISUSE, OR INAPPROPRIATE MODIFICATION OR REPAIR.

SUITABILITY FOR USE

ABB JOKAB SAFETY shall not be responsible for conformity with any standards, codes, or regulations that apply to the combination of products in the customer's application or use of the product. At the customer's request, ABB JOKAB SAFETY will provide applicable third party certification documents identifying ratings and limitations of use that apply to the products. This information by itself is not sufficient for a complete determination of the suitability of the products in combination with the end product, machine, system, or other application or use.

The following are some examples of applications for which particular attention must be given. This is not intended to be an exhaustive list of all possible uses of the products, nor is it intended to imply that the uses listed may be suitable for the products:

Outdoor use, uses involving potential chemical contamination or electrical interference, or conditions or uses not described in this document.

Nuclear energy control systems, combustion systems, railroad systems, aviation systems, medical equipment, amusement machines, vehicles, and installations subject to separate industry or government regulations.

Systems, machines, and equipment that could present a risk to life or property.

Please know and observe all prohibitions of use applicable to the products.

NEVER USE THE PRODUCTS FOR AN APPLICATION INVOLVING SERIOUS RISK TO LIFE OR PROPERTY WITHOUT ENSURING THAT THE SYSTEM AS A WHOLE HAS BEEN DESIGNED TO ADDRESS THE RISKS, AND THAT THE ABB JOKAB SAFETY PRODUCT IS PROPERLY RATED AND INSTALLED FOR THE INTENDED USE WITHIN THE OVERALL EQUIPMENT OR SYSTEM.

PERFORMANCE DATA

While every effort has been taken to ensure the accuracy of the information contained in this manual ABB JOKAB SAFETY cannot accept responsibility for errors or omissions and reserves the right to make changes and improvements without notice. Performance data given in this document is provided as a guide for the user in determining suitability and does not constitute a warranty. It may represent the result of ABB JOKAB SAFETY'S test conditions, and the users must correlate it to actual application requirements. Actual performance is subject to the ABB JOKAB SAFETY Warranty and Limitations of Liability.

Table of Contents

1	Introduction	4
	Scope	4
	Audience	4
	Prerequisites	4
	Special notes	4
2	Overview	5
	General description.....	5
	Safety regulations	5
	Function description.....	6
	Variants	8
3	Connections	10
4	Installation and maintenance	11
	Installation.....	11
	Maintenance	12
	Minimum safety distance	13
5	Application example.....	14
6	Model overview.....	15
	Accessories.....	15
	Safe lock	15
	Dimensions	16
	Actuators	17
	Dimensions	17
7	Technical data	18
8	EC Declaration of conformity	20

1 Introduction

Scope

The purpose of these instructions is to describe the safety interlock switch MKey8-series, and to provide the necessary information required for assembly, installation, checks and adjustments after installation, and maintenance. The instructions also include information necessary to connect MKey8 to a safety circuit.

Audience

This document is intended for authorized installation personnel.

Prerequisites

It is assumed that the reader of this document has knowledge of the following:

- Basic knowledge of ABB Jokab Safety products.
- Knowledge of safety devices and safety locks.
- Knowledge of machine safety.

Special notes

Pay attention to the following special notes in the document:

 **Warning!** Danger of severe personal injury!
An instruction or procedure which, if not carried out correctly, may result in injury to the technician or other personnel.

Caution! Danger of damage to the equipment!
An instruction or procedure which, if not carried out correctly, may damage the equipment.

NB: Notes are used to provide important or explanatory information.

2 Overview

General description

MKey8 interlock switches are designed to provide position interlock detection for moving guards. They are designed to fit the leading edge of sliding, hinged or lift off machine guards. The actuator is fitted to the moving part of the guard and is aligned to the switch entry aperture. The possibility to lock the switch in the protective position prevents unwanted access to machinery until dangerous operations have ceased.

The locking is useful when applications include:

- processes which cannot be interrupted, such as welding.
- machinery with a long stopping procedure, such as paper machinery that requires a long braking operation.
- prevention of unauthorised access to a particular area.

Safety regulations

Warning!

Carefully read through this entire manual before using the device.

The devices shall be installed by a trained electrician following the Safety regulations, standards and the Machine directive.

Failure to comply with instructions, operation that is not in accordance with the use prescribed in these instructions, improper installation or handling of the device can affect the safety of people and the plant.

For installation and prescribed use of the product, the special notes in the instructions must be carefully observed and the technical standards relevant to the application must be considered.

In case of failure to comply with the instructions or standards, especially when tampering with and/or modifying the product, any liability is excluded.

Function description

Safety interlock switches with guard locking are designed to fit to the leading edge of sliding or hinged guard doors to provide positively operated switching contacts and provide a tamper resistant key mechanism. They are designed to provide robust position interlock detection and to keep closed of moving guards. The switch is rigidly mounted to the frame of the guard or machine. The actuator is fitted to the moving part of the guard and is aligned to the switch entry aperture. The actuator profile is designed to match a cam mechanism within the switch head and provides a positively operated not easily defeatable interlock switch. When the guard is closed, the actuator inserted in the switch and the switch locked, the machine can be able to start. When the solenoid is energised (MKey8, MKey8Z, MKey8ER) the safety contacts are positively opened, and the guard door can be opened.

The MKey8 is available in two basic versions, either with a spring lock or an electro-magnetic lock. In the spring lock version, the locking mechanism moves into the locked position directly when the door is closed and the actuator key is pushed into the switch. The actuator key can only be released and the gate opened by supplying operating voltage to the solenoid (A1-A2).

MKey8M is an electro-magnetic lock version, the locking mechanism is only in the locked position when the solenoid (A1-A2) is supplied with operating voltage. Release of the actuator key is only possible when the operating voltage is not applied to the solenoid (A1-A2). The solenoid voltage can be 24VDC or 230VAC depending on choice.

The MKey8ER has an escape rear release “unlocking” facility to enable the actuator key to be released without the energisation of the solenoid (A1-A2).

The MKey8 has double forced disconnection contacts connected to the actuator key and the locking mechanism. The actuator key is designed to prevent tampering with tools, magnets or similar objects. To achieve highest safety level in connection with the machine control system it is recommended that the MKey8 is monitored by an appropriate ABB Jokab Safety safety relay, Pluto safety PLC or Vital system. To obtain the highest level of safety, two switches per gate are required.

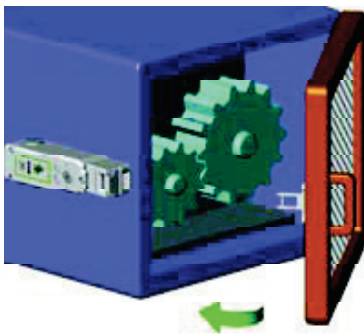

Hinged guard

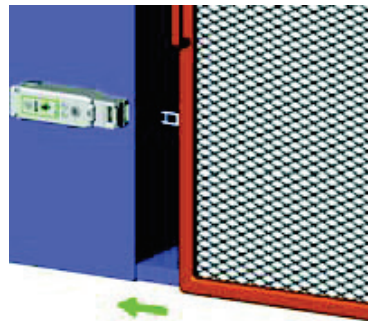

Sliding guard

Warning! Application consideration must be given to the fixing of the actuator which has to be in a way that prevents disassembly by easy means.

The heads can be set in four positions, thus providing the safety device with eight different operation positions. The leading edges of the actuator key are reinforced and bevelled in order to guide it properly into the hole. The MKey8 series have been developed with a high holding force of 2000N MKey8 has several types of actuators as options. A standard actuator key is always delivered with interlock switches.



Note! Top or side manual release points (not on MKey8M)

Variants

MKey8 – Standard version with spring lock

The version of MKey8 with die cast housing and spring lock. The switch has a contact block configuration of 2NC+2NC with positive force disconnection contacts. One pair closes when the actuator key is pushed into the head (2NC). The other pair closes when the locking mechanism is in the locked position (2NC). There are two NO auxiliary circuits, 1 NO circuit for indication of guard open and on another 1 NO circuit for indication of lock status.



MKey8Z – Stainless steel version with spring lock

MKey8Z – Stainless steel version with rugged stainless steel housing and spring lock. The switch has a contact block configuration of 2NC+2NC with positive force disconnection contacts. One pair closes when the actuator key is pushed into the head (2NC). The other pair closes when the locking mechanism is in the locked position (2NC). There are two NO auxiliary circuits, 1NO circuit for indication of guard open and on another 1 NO circuit for indication of lock status.



MKey8M – Power to lock version with magnetic lock

The version of MKey8 with die cast housing and magnetic lock. The switch has a contact block configuration of 2NC+1x(NC+NO) with positive force disconnection contacts. One pair closes when the actuator key is pushed into the head (1NC+1NO). The other pair closes when the locking mechanism is in the locked position (2NC). A 1NO/1NC circuit gives an indication of actuator status.



MKey8ER - Standard version with escape release

The version of MKey8 with die cast housing and spring lock with escape release. The switch has a contact block configuration of 2NC + 2NC with positive force disconnection contacts. One pair closes when the actuator key is pushed into the head (2NC). The other pair closes when the locking mechanism is in the locked position (2NC). There are two NO auxiliary circuits, 1NO circuit that indicates guard open and 1NO circuit that indicates lock status.

The MKey8ER has a manual release button at the rear of the housing. This can be used where the risk assessment for the application permits, a non latching manual escape of the switch lock in case of emergency. The switch must be mounted so that the release button is reachable from inside the active guard area. Press and holding the red button will release the lock mechanism and lock monitoring contacts while the guard can be pushed open.

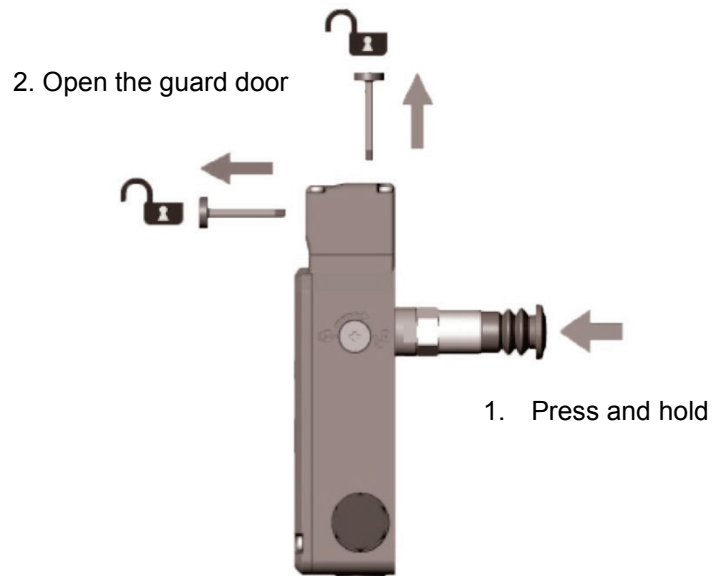

3 Connections

See Chapter Installation and Maintenance for more information regarding installation.

Connections

MKey8/MKey8Z/MKey8ER

MKey8M

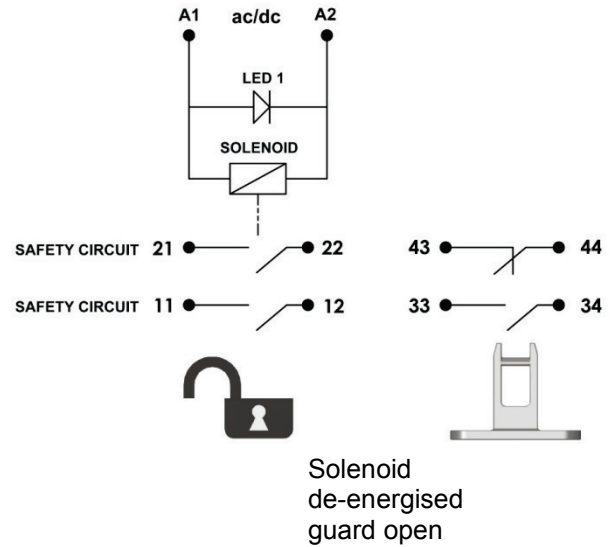
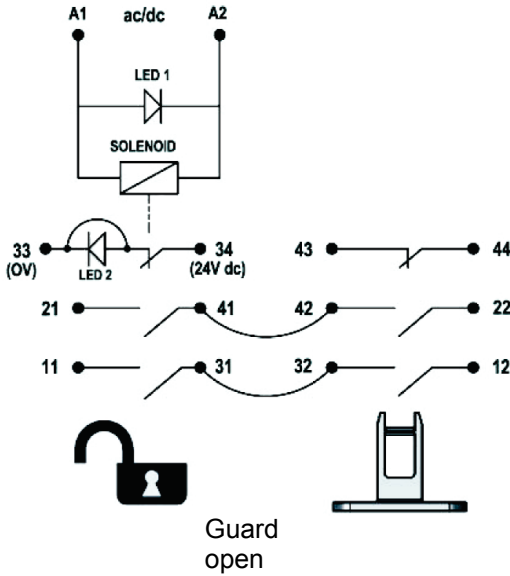

LED1 status of solenoid
LED2 status of lock

(Terminals 33-34 are selectable, to be used either as power feed to LED2 or as a voltage free auxiliary circuit to indicate lock status)

Actuator insertion

	6.0	5.0	0 mm
11/12	Open		
21/22	Open		
33/34			Open
43/44			Open

	6.0	5.0	0 mm
11/12	Open		Solenoid energised
21/22	Open		Solenoid energised
33/34	Open		Tongue Inserted
43/44		Open	Tongue Inserted

MKey8, MKey8Z, MKey8ER, Contacts at withdrawal of actuator.

Mkey8M, Contacts at withdrawal of actuator.

NB! Measurements in mm

4 Installation and maintenance

Installation

1. The installation of all ABB Jokab Safety interlock switches must be done in accordance with a risk assessment for the individual application. Installation must only be carried out by competent personnel and in accordance with these instructions.
2. M5 mounting bolts must be used to fix the switch and actuator, the tightening torque to ensure reliable fixing is 4.0 Nm. To prevent loosening of the switch after installation, always fix the M5 mounting bolts with a thread-locking compound or secure using self locking nuts. Tightening torque for the lid screws, conduit entry plugs and cable glands must be 1.5 Nm to ensure IP seal.

Only use the correct size gland for the conduit entry and cable outside diameter.

Tightening torque for the connection terminal screws is 0,7 Nm, max conductor size is 1,0 mm². The switch head position can be selected by removing the actuator, loosening the 4 head bolts and then rotating the head to the position required. Re-tighten the head bolts and then check actuator insertion and withdrawal.

Tightening torque for the head bolts is 1.5Nm.

3. Always fit a mechanical stop to the guard to prevent damage to the front of the switch.

Set the actuator gap to 3 mm when the guard is closed and against the stop. (See illustration).

Use alignment guides to ensure that the actuator enters the switch without interfering with the sides of the aperture.

Ensure access to at least one of the manual release points.

Always fit the aperture plug to the unused entry aperture to prevent debris entering the switch mechanism.

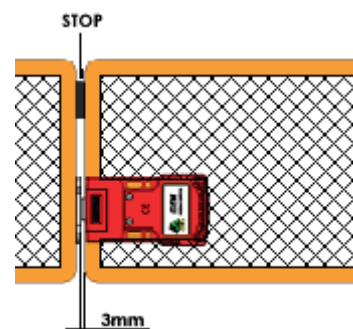

4. Always use the circuits 11-12 and 21-22 to ensure monitoring of the lock.

For MKey 8: At installation choose the status of Terminals 33 and 34 by setting the slide switch inside the switch housing. (Terminals 33 – 34 are selectable to be used either as power feed to LED2 or as a voltage free auxiliary circuit to indicate lock status).

If LED2 is used always check for correct DC polarity.

Terminal 33: 0VDC Terminal 34: +24VDC

LED1 Status of Solenoid

LED2 Status of Lock

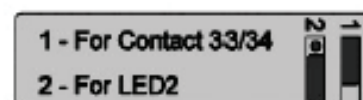

5. After installation check operation of all control circuits and the locking function. For applications with a run down time after turning off power, ensure that the correct time delay has elapsed before energising the solenoid.

LED 1 RED will illuminate when power is applied to A1 and A2 (solenoid feed).

LED 2 GREEN (if used) will be illuminated when the actuator is locked. (Not on MKey 9M)

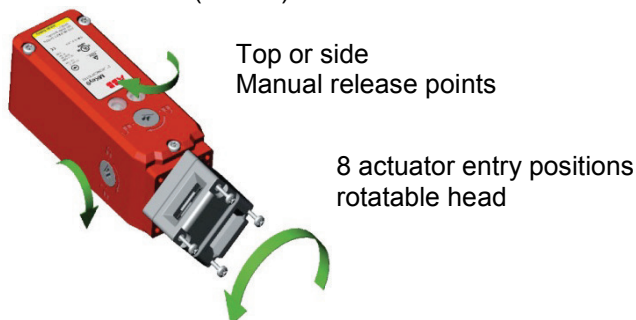



Warning! All the safety functions must be tested before starting up the system.

Maintenance

Every week: Check correct operation of all circuits. If the actuator shows signs of bending or the switch head housing displays mechanical damage then remove and replace.

Every 6 months: Isolate power and remove cover. Check screw terminal tightness and check for signs of moisture ingress.

 **Warning!** The safety functions and the mechanics shall be tested regularly, at least once every year to confirm that all the safety functions are working properly.

 **Warning!** In case of breakdown or damage to the product, contact the nearest ABB Jokab Safety Service Office or reseller. Do not try to repair the product yourself since it may accidentally cause permanent damage to the product, impairing the safety of the device which in turn could lead to serious injury to personnel.

Caution! ABB Jokab Safety will not accept responsibility for failure of the switch functions if the installation and maintenance requirements shown in this sheet are not implemented. These requirements form part of the product warranty.

Caution! The switch solenoid is rated for continuous duty, and temperature rise will occur if left permanently energised. The temperature will not affect performance of the switch function, life time or damage the housing. As a precaution it is always advised to limit the energised time of the solenoid(not on MKey8M) and where possible and avoid mounting on sensitive surfaces (metal preferred).

Minimum safety distance

When using interlocking guards without guard locking to safeguard a hazard zone, the minimum allowed safety distance between the guarded opening and the hazardous machine must be calculated. In order to ensure that the hazardous machine motion will be stopped before it can be reached, the minimum safety distance is calculated according to EN ISO 13855 ("Positioning of safeguards with respect to the approach speeds of parts of the human body").

The minimum safety distance is calculated according to the formula:

$$S = (K \times T) + C$$

Where

S = minimum safety distance (mm)

K = approach speed of a human body; 1600 mm/s

T = the total time from opening of the guard until the hazardous machine movement has stopped, i.e. including control system reaction times and other delays (s)

C = a safety distance taken from Table 4 or Table 5 of EN ISO 13857:2008, if it is possible to push fingers or a hand through the opening towards the hazard before a stop signal is generated

NB: In some cases, T might be reduced by the opening time of the guard until the opening size permits access of the relevant parts of the body. Refer to EN ISO 13855 for further details and EN ISO 13857 for specified values.

5 Application example

Application example - Door Interlock with guard locking - Dual Channel non monitored

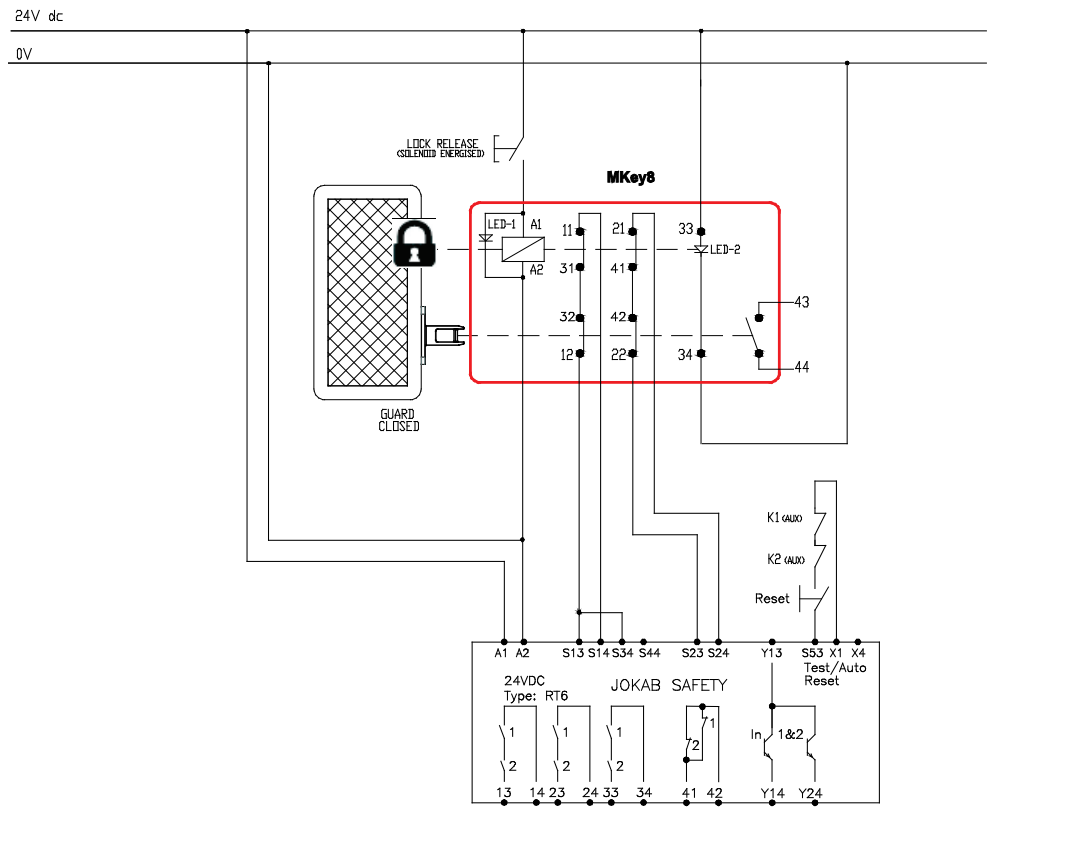

6 Model overview

Type	Article number	Description
MKey8	2TLA050011R0132	Spring lock, M20, 24VDC, Standard Key
MKey8	2TLA050011R0134	Spring lock, M20, 230VAC, Standard Key
MKey8M	2TLA050013R0132	Electro-magnetic lock, M20, 24VDC, Standard Key
MKey8M	2TLA050013R0134	Electro-magnetic lock, M20, 230VAC, Standard Key
MKey8ER	2TLA050015R0132	Spring lock with escape release, M20, 24VDC, Standard Key
MKey8ER	2TLA050015R0134	Spring lock with escape release, M20, 230VAC, Standard Key
MKey8Z	2TLA050011R0122	Spring lock, M20, 24VDC, Stainless steel, Standard Key
MKey8Z	2TLA050011R0124	Spring lock, M20, 230VAC, Stainless steel, Standard Key

Accessories

Type	Article number	Description
Gland	2TLA050040R0002	Stainless steel cable gland M20 x 1.5
Tina 2A	2TLA020054R0100	Adaptation unit for dynamic circuit with M20 fitting.
Tina 2B	2TLA020054R1100	Adaptation unit for dynamic circuit, internal assembly.
Tina 3A	2TLA020054R0200	Adaptation unit for dynamic circuit with M20 fitting and M12 connector
Release key	2TLA050040R0400	Manual release key for MKey8Z
Lockout actuator	2TLA050040R0401	Lockable service key for maintenance
Slide Lock Left	2TLA050040R0500	Slide Lock for MKey8, 9 for left hinged door
Slide Lock Right	2TLA050040R0501	Slide Lock for MKey8, 9 for right hinged door
Rear Handle	2TLA050040R0510	Handle for inside operation for Slide Lock
Spring Catch	2TLA050040R0511	Spring loaded catch for Slide Lock

Safe lock

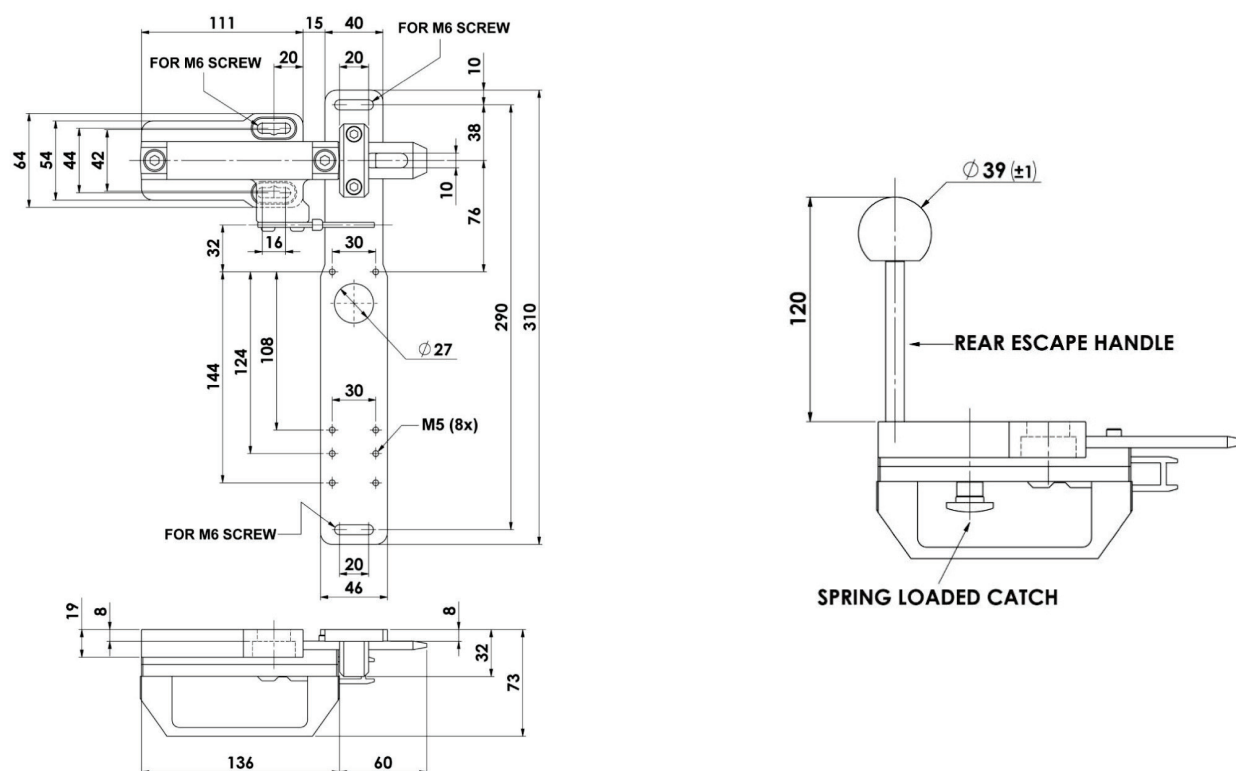

Dimensions

MKey8, MKey8M, MKey8Z

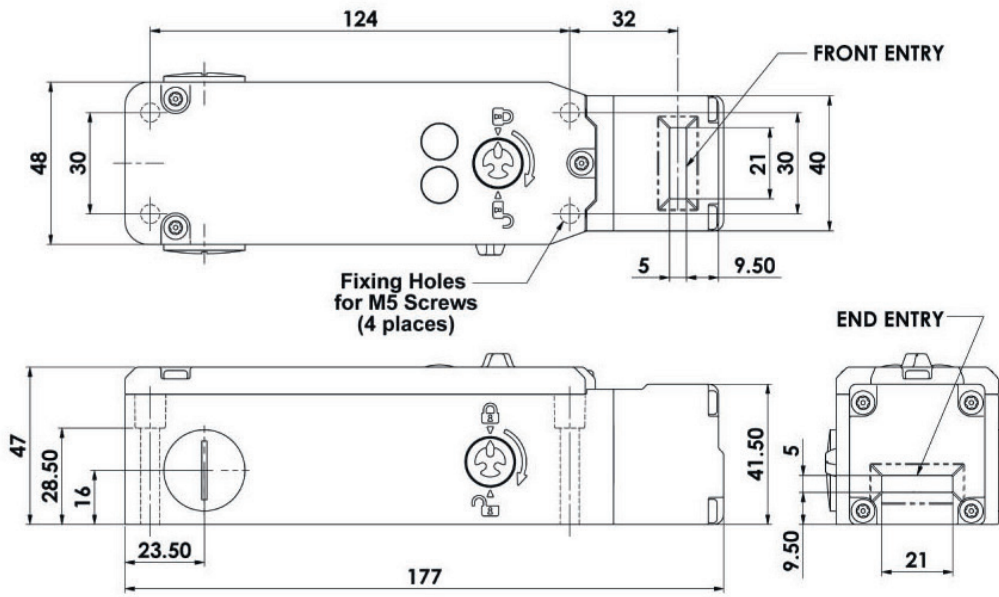

MKey8ER

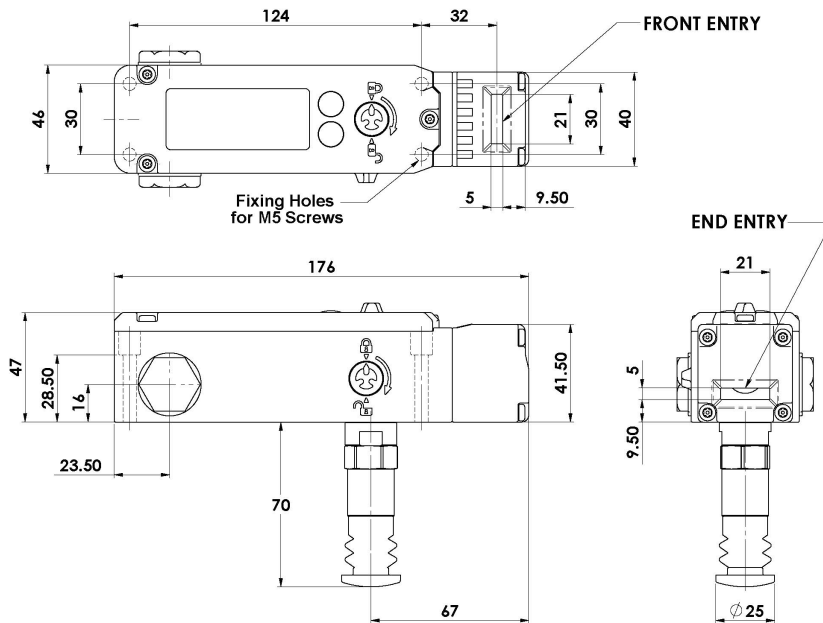

NB: All measurements in millimetres.

Actuators

All keys are in stainless steel.

Type	Article number	Description
1	2TLA050040R0202	Standard key
2	2TLA050040R0220	Flat key
3	2TLA050040R0203	Flexible key with metal housing
4	2TLA050040R0204	Flexible key with stainless steel housing



1



2

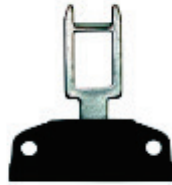

3



4

Dimensions

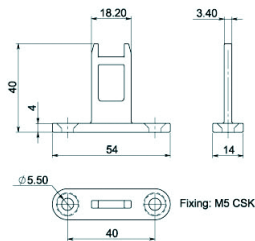

1

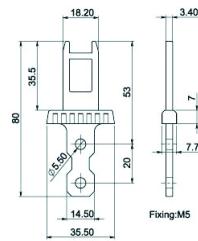

2

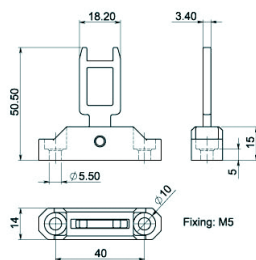

3

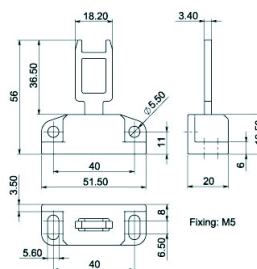

4

NB: All measurements in millimetres.

7 Technical data

Manufacturer

Address	ABB AB / JOKAB SAFETY Varlabergsvägen 11 SE-434 39 Kungsbacka Sweden
---------	---

Electrical characteristics

Utilization category	AC-15 A300 3A
Thermal current	10A
Rated insulation/withstand voltages	600 VAC/2500 VAC
LED 2 supply voltage	24VDC +/-10%
Solenoid power consumption	12 W (MKey8M, inrush current 1.5A)
Solenoid voltage (by part number)	24VDC +/-10% or 230VAC +/-10%
Auxiliary Contact 33/34 (selectable with LED2)	230VAC/DC 500mA max. (Not on MKey8M)
Auxiliary Contact 43/44	230VAC/DC 500mA max. (MKey8M 24V 200mA max.)

General

Travel for positive opening	10 mm
Actuation Frequency	2 cycle/sec
Actuator entry minimum radius	175 mm Standard Key 100 mm Flexible Key
Protection class	MKey8, MKey8M, MKey8ER: IP67 MKey8Z: IP67, IP69K
Ambient temperature	MKey8, MKey8ER, MKey8Z: -25...+80°C MKey8M: -25...+40°C
Size	See drawing
Conduit entries	3 x M20 x 1.5
Material	MKey8, MKey8M, MKey8ER: Die cast painted red MKey8Z: Stainless steel 316
Fixing	Body: 4 x M5 Actuator: 2 x M5
Maximum approach / withdrawal speed	600 mm/s
Holding force	2000N (Max.)
Vibration	IEC 68-2-6, 10-55 Hz+1 Hz, Excursion: 0.35 mm, 1 octave/min

Safety-related characteristic data and Conformity

Conformity	European Machinery Directive 2006/42/EC EN ISO 12100:2010, EN 1088:1995+A2:2008, EN 60204- 1:2006+A1:2009 EN 60947-1:2007+A1:2011, EN 60947-5-1:2004+A1:2009
EN ISO 13849-1	Up to PL e, Cat. 4 depending on system architecture
EN 62061	Up to SIL3 depending on system architecture
Safety data	
B _{10d}	2,500,000 operations at 100 mA load
MTTF _d	356 years (8 cycles per hour / 24 hours per day / 365 days per year)
Proof test interval (Life)	35 years
Certifications	TÜV, cULus
Information with regard to UL 508	Use 12AWG copper conductors only Electrical Rating: A300 48W5 Type 1 Enclosure Max. Switching Current / Volt / Amp: 120V 6A (720VA break) PF 0.38, 240V 3A (720VA break) PF 0.38

NB: A single MKey8 can achieve performance level PL c according to EN ISO 13849 if used correctly with an ABB Jokab Safety safety relay, Pluto safety-PLC or Vital safety module. If two MKey8-switches are used for the same safety function, a performance level up to PL e can be achieved. Refer to EN ISO 13849 for details on how to achieve this if necessary.

8 EC Declaration of conformity



EC Declaration of conformity

(according to 2006/42/EC, Annex 2A)

We **ABB AB**
JOKAB Safety
Varlabergsvägen 11
SE-434 39 Kungsbacka
Sweden

declare that the safety components of ABB AB manufacture with type designations and safety functions as listed below, is in conformity with the Directives
2006/42/EC
2006/95/EC

Authorised to compile the technical file

ABB AB
JOKAB Safety
Varlabergsvägen 11
SE-434 39 Kungsbacka
Sweden

Product

Safety interlock switches

MKey1 MKey2 MKey4
MKey4+ MKey5 MKey5+
MKey5+Z MKey5Z MKey6
MKey6+ MKey 6+Z MKey6Z
MKey8 MKeyER MKey8ERZ
MKey8M MKey8Z MKey 8
MKey9M

Used harmonized standards

EN ISO 12100:2010, EN 1088:1995+A2:2008,
EN 60204-1:2006:+A1:2009

Other used standards

EN 60947-1:2007:+A1:2011,
EN 60947-5-1:2004:+A1:2009



Jesper Kristensson
PRU Manager
Kungsbacka 2012-08-06

www.abb.com
www.jokabsafety.com

Original

ABB AB / JOKAB SAFETY Varlabergsvägen 11, SE-434 39 Kungsbacka, Sweden

www.abb.com/jokabsafety