

# ***INSTRUCTION MANUAL***

## **Smart Transmitter Terminal STT04**

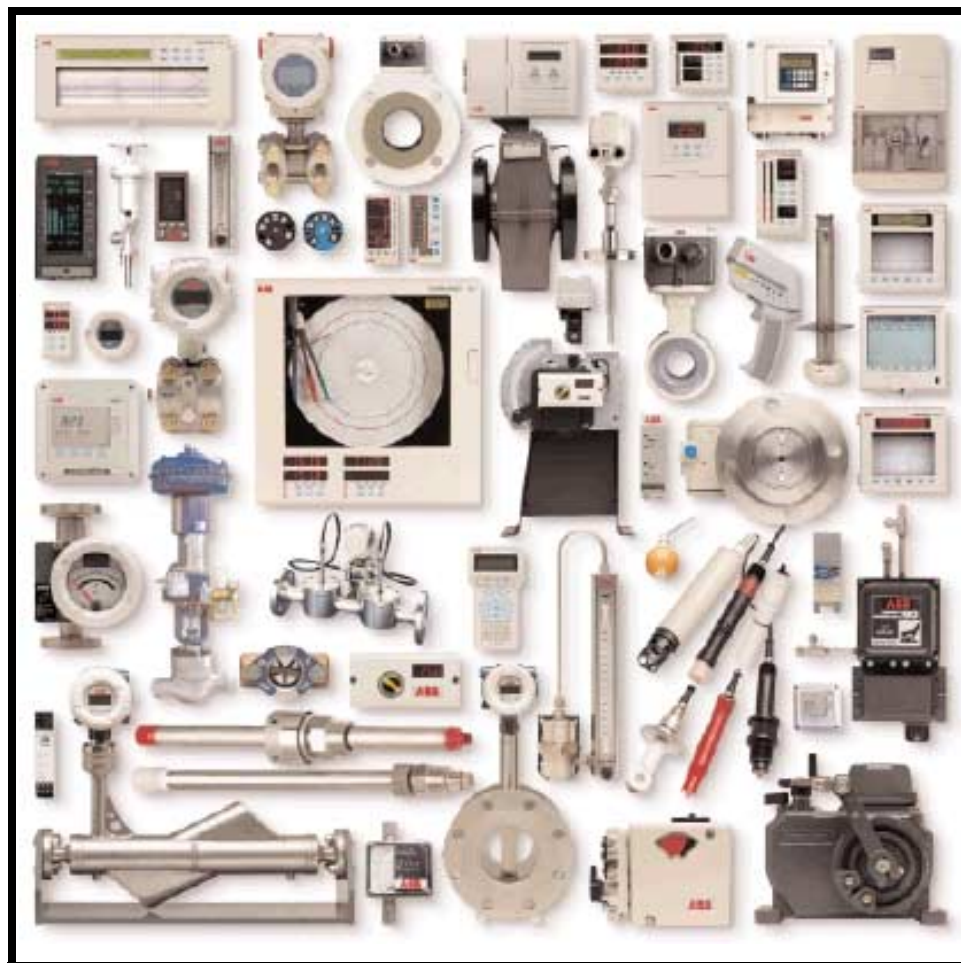

PN25054

---

# Trademarks and Registrations

Registrations and trademarks used in this document include:

® Windows	Registered trademark of Microsoft Corporation
® Windows NT	Registered trademark of Microsoft Corporation
® Lexan	Registered trademark of General Electric Company, GE Plastics Division

**WARNING** notices as used in this manual apply to hazards or unsafe practices which could result in personal injury or death.

**CAUTION** notices apply to hazards or unsafe practices which could result in property damage.

**NOTES** highlight procedures and contain information which assist the operator in understanding the information contained in this manual.

All software, including design, appearance, algorithms and source codes, is copyrighted by ABB Inc. and is owned by ABB Inc. or its suppliers.

## WARNING

**POSSIBLE PROCESS UPSETS.** Maintenance must be performed only by qualified personnel and only after securing equipment controlled by this product. Adjusting or removing this product while it is in the system may upset the process being controlled. Some process upsets may cause injury or damage.

## NOTICE

The information contained in this document is subject to change without notice.

ABB Inc., its affiliates, employees, and agents, and the authors of and contributors to this publication specifically disclaim all liabilities and warranties, express and implied (including warranties of merchantability and fitness for a particular purpose), for the accuracy, currency, completeness, and/or reliability of the information contained herein and/or for the fitness for any particular use and/or for the performance of any material and/or equipment selected in whole or part with the user of/or in reliance upon information contained herein. Selection of materials and/or equipment is at the sole risk of the user of this publication.

This document contains proprietary information of ABB Inc., and is issued in strict confidence. Its use, or reproduction for use, for the reverse engineering, development or manufacture of hardware or software described herein is prohibited. No part of this document may be photocopied or reproduced without the prior written consent of ABB Inc..

# STT04EB\_ Smart Transmitter Terminal

# ADDENDUM

## INTRODUCTION

This addendum supplements information contained in the WPBEEU110502B0 STT04 Product Instruction. The purpose of this addendum is to "map" or correlate function keys on the **revised STT04EBO** keypad to the **original STT04** keypad function keys that are documented in the Product Instruction. This addendum also provides supplemental 600TEN Transmitter information which is not contained in the existing STT04 Product Instruction. Refer to the STT04 Product Instruction for specific operating details.

## OPERATOR/INTERFACE CONTROLS

The illustrations below show the comparison between the old and new STT04 keypads:

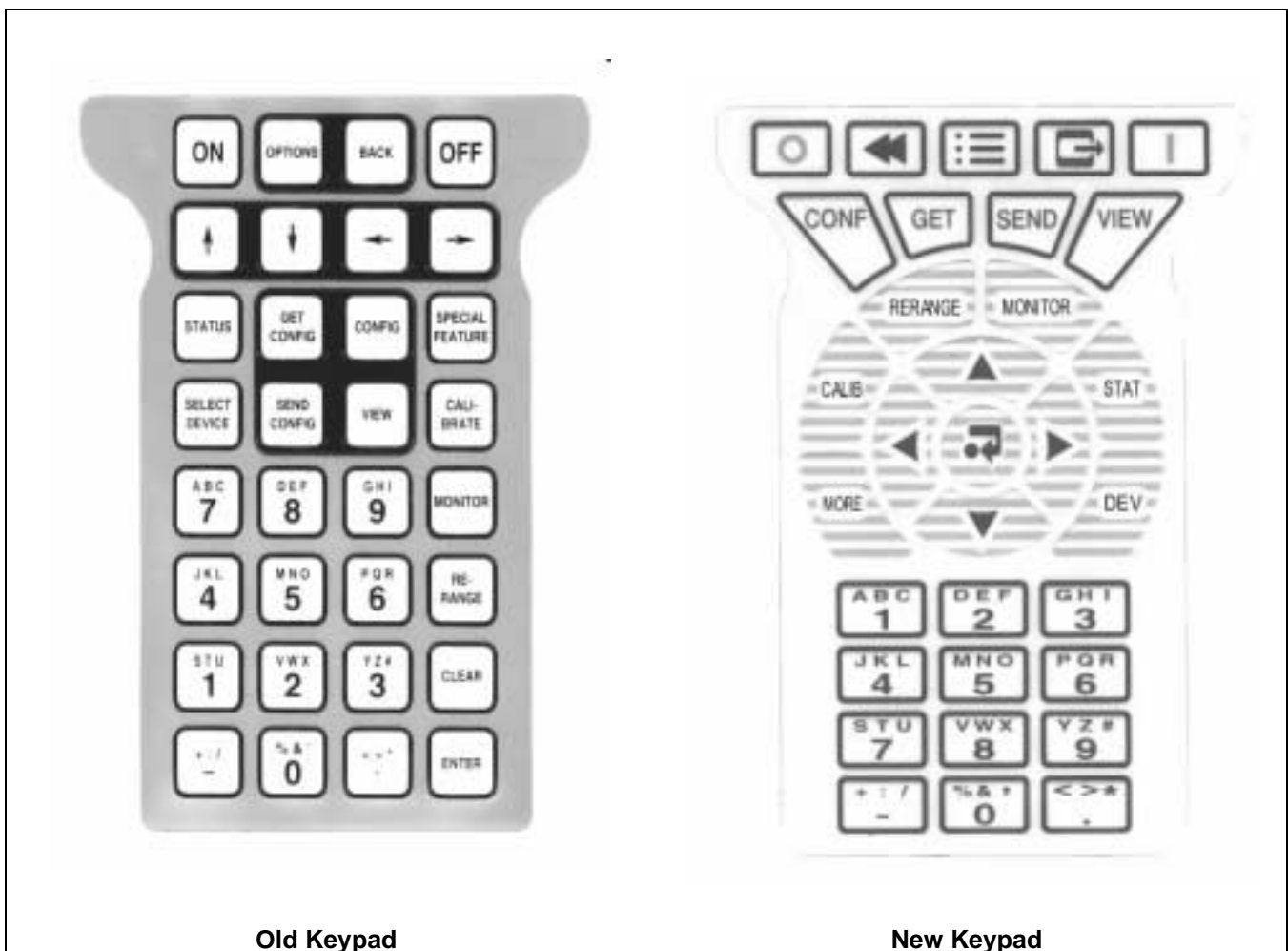

Old Keypad















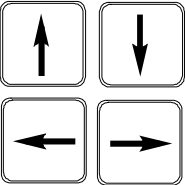

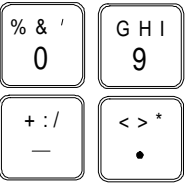



New Keypad

# ADDENDUM

Table 1 provides a comparison of old-keypad vs. new-keypad functions for the keys on the STT04 terminal.

















**NOTE: The configure, view, select device and options keys function without a field device connected to the STT04 terminal. The other functions are locked out until a field device is connected to the terminal.**

Table 1. Keypad Functions

Old Key	New Key	Function
		Powers the unit up and displays the STT04 firmware revision level.
		Turns power off. Stored configurations remain in internal memory. The terminal will shut itself off after 15 minutes of idle operation.
		Scrolls through menus and selects functions.
		Inputs values into the terminal. Includes digits 0 through 9, ASCII characters A through Z, signs, and punctuation.
		Completes an input or a selection.
		<ol style="list-style-type: none"> <li>1. Inputs a new configuration into the STT04 internal memory.</li> <li>2. Modifies an existing configuration.</li> <li>3. Erases an existing configuration from the terminal memory.</li> </ol>
		Retrieves, views and optionally saves the configuration of the selected field device.
		Sends a configuration from the STT04 terminal to a selected field device.
		Steps through various calibration procedures (dependent on the selected field device).
		Monitors primary input or output, secondary output, ambient temperature of the selected field device, and other variables.

# ADDENDUM

Table 1. Keypad Functions(continued)

Old Key	New Key	Function
		Displays field device status based on results of continuous self-diagnostics.
		<ol style="list-style-type: none"> <li>1. Changes engineering units.</li> <li>2. Sets lower and upper range values of primary and secondary units.</li> <li>3. Changes the output dampening.</li> </ol>
		<ol style="list-style-type: none"> <li>1. Sets output to a fixed value.</li> <li>2. Cancels a fixed output.</li> <li>3. Sets up LCD - select display units to be displayed on the field device LCD.</li> <li>4. Changes device configuration to the standard configuration (PTS only).</li> </ol> <p>NOTE: For special feature functions for the Type AVS Smart Positioner, refer to Appendix A.</p>
		Escapes the current function and returns the display to the <i>READY</i> condition.
		Selects and changes working configurations and field devices (if connected).
		Steps through the selections of the working configuration. Views a configuration, but does not allow modifications to be made.
		<ol style="list-style-type: none"> <li>1. Sets the language of the display screens.</li> <li>2. Sets the communication format.</li> <li>3. Displays the amount of charge left on the battery pack.</li> <li>4. Displays the STT04 name.</li> </ol>
		Returns to a previous screen during configuration, calibration, rerange, etc.

## APPENDIX - 600T & 600TEN PRESSURE TRANSMITTER

### INTRODUCTION

This appendix covers the configuration and calibration functions of the Type 600T EN Pressure Transmitter. Refer to SECTION 4 - OPERATING PROCEDURES for information on the following functions:

- Send configurations.
- Get configurations.
- View configurations.
- Select configurations.
- Erase configurations.
- Operational functions.

### CREATE/MODIFY CONFIGURATION

A configuration can be created off-line, without a connected field device. Refer to Figure 1 for an overview of the configuration function. The following table details the configuration process.

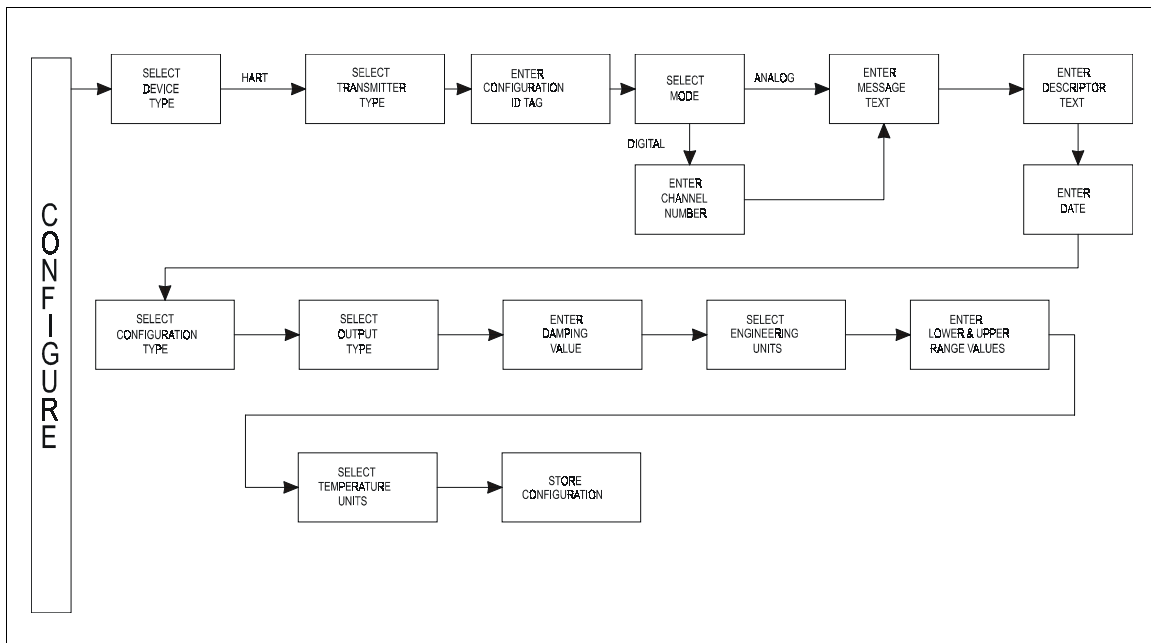

















Figure 1. Configuration Flowchart (600T & 600T EN)

# ADDENDUM







Key	Display	Comments
	CONFIGURATION → NEW MODIFY ERASE	Select <i>NEW</i> to create a configuration. To modify an existing configuration, select <i>MODIFY</i> . The screen sequence is the same, however, the <i>MODIFY</i> screens will appear with the values and arrow positions as they were originally configured.
		
	DEVICE TYPE BAILEY FSK → HART	Select <i>HART</i> .
		
 [ 6 TIMES ]	TRANSMITTER TYPE PTH EBTH TB82 pH TB82 ORP TB82 pION TB82 CONC TZID/AXH AS800 TEU211 TS11/TS01 50XE4000 50XM2000 50SM*1000 →600T HART UNIV	Select <i>600T</i> .
		
		
	STT04 CONFIGURATION [ ] ←PREVIOUS NEXT→	Enter a name for the configuration ID tag using up to eight ASCII characters. To select a character, press the key that has the desired character. Continue to press the key until the desired character appears. Use the right arrow key to move to the next character. Use the left arrow key to go back to the previous character.
	SELECT MODE: → ANALOG DIGITAL	Select <i>ANALOG</i> .  NOTE: <i>The DIGITAL selection should only be made when using an IMFBS01 field bus I/O module. A CHANNEL # prompt appears when DIGITAL is selected.</i>

# ADDENDUM

Key	Display	Comments
	<div style="border: 1px solid black; padding: 5px;"> <p>MESSAGE:</p> <p>←PREVIOUS    NEXT→</p> </div>	<p>Type a descriptive message using up to 32 characters. This field can be used to note anything of importance to the device or installation.</p> <p>To select a character, press the key that has the desired character. Continue to press the key until the desired character appears. Use the right arrow key to move to the next character. Use the left arrow key to go back to the previous character.</p>
	<div style="border: 1px solid black; padding: 5px;"> <p>DESCRIPTOR:</p> <p>←PREVIOUS    NEXT→</p> </div>	<p>Type a descriptor string using up to 16 characters. This field can be used for notations about the device or process.</p> <p>To select a character, press the key that has the desired character. Continue to press the key until the desired character appears. Use the right arrow key to move to the next character. Use the left arrow key to go back to the previous character.</p>
	<div style="border: 1px solid black; padding: 5px;"> <p>DATE:</p> <p>DAY: nn</p> <p>MONTH: nn</p> <p>YEAR: nn</p> </div>	<p>Enter a day and press <b>ENTER</b>. Enter a month and press <b>ENTER</b>. Enter a year and press <b>ENTER</b>.</p> <p>This date can represent the creation date of the configuration, the date the device or element was installed, or some other significant date.</p>
	<div style="border: 1px solid black; padding: 5px;"> <p>CONFIG TYPE</p> <p>600T</p> <p>→ 600T EN</p> </div>	<p>Select <i>600T EN</i></p>
		
	<div style="border: 1px solid black; padding: 5px;"> <p>OUTPUT TYPE</p> <p>→ LINEAR</p> <p>SQU (x)</p> <p>SQR (x^3)</p> <p>SQR (x^5)</p> <p>5th ORD. POLY</p> <p>DOUBLE POLYN</p> </div>	<p>Select <i>LINEAR</i>.</p> <p><b>NOTE:</b> Other output type selections are:</p> <p><i>SQUARE ROOT</i></p> <p><i>SQR (x^3)</i></p> <p><i>SQR (x^5)</i></p> <p><i>5th ORDER POLYNOMIAL</i></p> <p><i>DOUBLE POLYN</i></p> <p>Use <b>BACK</b> to return to a previous configuration screen from any screen in the configuration process.</p>
	<div style="border: 1px solid black; padding: 5px;"> <p>DAMPING:</p> <p>(0 - 16 SEC)</p> <p>0.5 SECS</p> </div>	<p>Enter a value between 0 and 16 seconds.</p>



# ADDENDUM

Key	Display	Comments
	<p>ENGINEERING UNIT            → iH2O-20c            iHg-0°C            ftH2O-20c            mmH2O-20c</p>	<p>Select an engineering unit best suited for the application. Other units not shown include <i>mmHg-0°C</i>, <i>PSI</i>, <i>BARS</i>, <i>mBAR</i>, <i>gSqCm</i>, <i>Kgcm2</i>, <i>PA</i>, <i>KPA</i>, <i>torr-0°C</i>, <i>ATM</i>, <i>MPa</i>, <i>iH2O-4°C</i>, <i>mmH2O-4°C</i>.</p>
	<p>LOWER RANGE VAL            nn.nn UNITS            UPPER RANGE VAL            nn.nn UNITS</p>	<p>Input lower range value using the number keys, then press <b>ENTER</b>. Input the upper range value, then press <b>ENTER</b>.</p>
	<p>TEMPERATURE UNITS            → °C °F            °R °K</p>	<p>Select the 600T EN <i>TEMPERATURE UNITS</i>. Use arrow key to select option, then press <b>ENTER</b>.</p>
	<p>STORE THIS CONFIGURATION?            NO            → YES</p>	<p>Select <i>YES</i>.</p>
		
	<p>ID TAGNAME            READY</p>	

## CALIBRATION

This section details the 600T EN pressure transmitter calibration functions using an STT04 terminal. There are four types of calibration functions:

- Sensor Trim
- D-to-A adjust (Analog Mode only)
- PV Bias
- Set Output %

Refer to Figure 2 for an overview of the calibration functions.

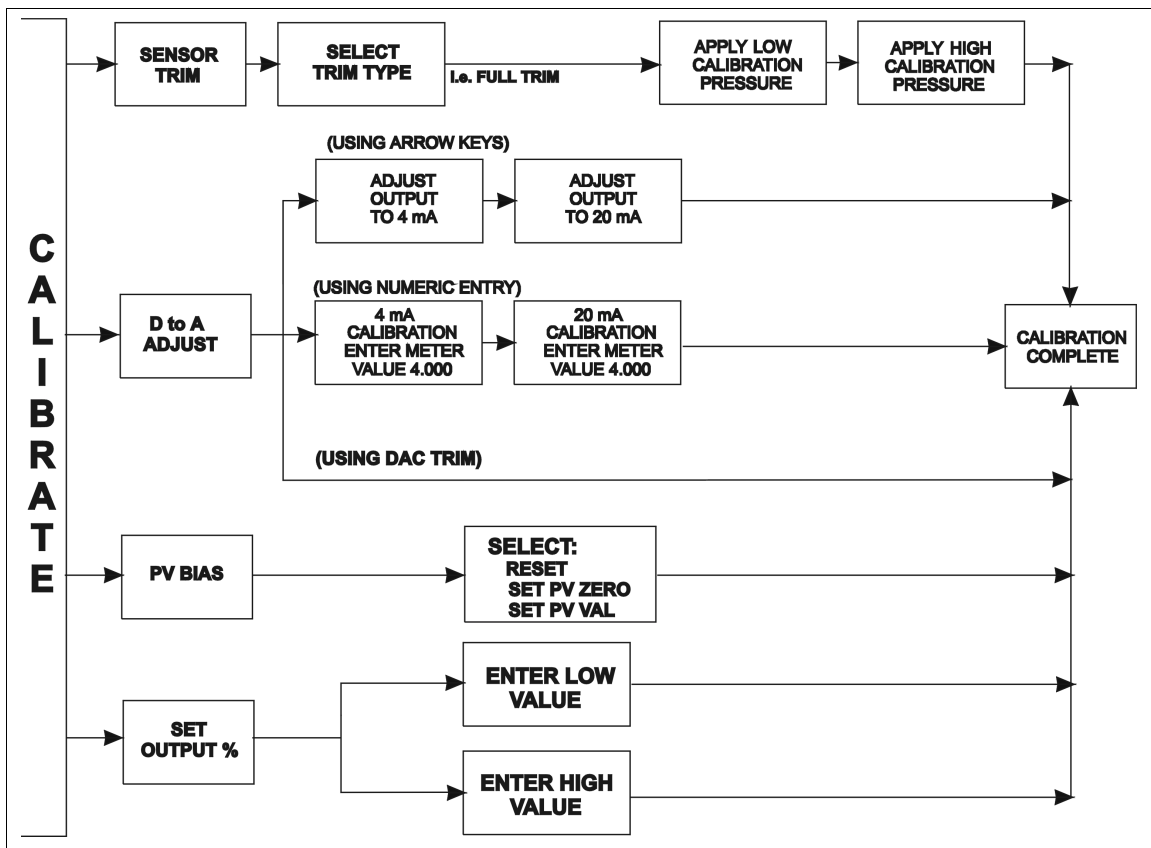

Figure 2. Calibration Flowchart (600T EN)









# ADDENDUM

## Sensor Trim

This procedure allows calibration of the pressure sensors for 600T EN pressure transmitters. Selections available are FULL TRIM, ZERO TRIM, FACTORY TRIM and STATIC TRIM.

### FULL TRIM









Use this option if both LOW (min.) and HIGH (max.) pressure settings are to be calibrated.

Key	Display	Comments
	OUTPUT WILL BE AFFECTED! PROCEED? NO → YES	This operation will cause a change in output not corresponding to the input. Be sure the control loop is in manual.  Select <b>YES</b> .
		
		
	→ SENSOR TRIM D-TO-A ADJUST PV BIAS SET OUTPUT %	Select <b>SENSOR TRIM</b> , or select calibration option with down-arrow key and refer to the appropriate section. Press <b>ENTER</b> when done.
	→ FULL TRIM ZERO TRIM FACTORY TRIM STATIC TRIM	Select <b>FULL TRIM</b> .
	LOW CALIB PRESSURE nn.nn UNITS HIGH CALIB PRESSURE nn.nn UNITS	Enter the low calibration pressure value using the number keys and press <b>ENTER</b> . Similarly, enter the high calibration pressure value, then press <b>ENTER</b> .
	APPLY PRESSURE OF nn.nn UNITS  THEN HIT ENTER	Apply the low calibration pressure to the input of transmitter as specified earlier.
	APPLY PRESSURE OF nn.nn UNITS  THEN HIT ENTER	Apply the high calibration pressure to the input of transmitter as specified earlier.

# ADDENDUM

## ZERO TRIM









Use this option if only the LOW (min.) pressure setting is to be calibrated

Key	Display	Comments
	OUTPUT WILL BE AFFECTED! PROCEED? NO → YES	This operation will cause a change in output not corresponding to the input. Be sure the control loop is in manual.  Select <b>YES</b> .
		
		
	→ SENSOR TRIM D-TO-A ADJUST PV BIAS SET OUTPUT %	Select <b>SENSOR TRIM</b> , or select calibration option with down-arrow key and refer to the appropriate section. Press <b>ENTER</b> when done.
	FULL TRIM → ZERO TRIM FACTORY TRIM STATIC TRIM	Select <b>ZERO TRIM</b> .
		
	APPLY 0 INPUT TO SENSOR  THEN HIT ENTER	Apply the pressure equal to the zero value of the instrument and press <b>ENTER</b> .
	APPLIED ZERO INPUT: <i>value</i> units PRESS ENTER TO CONTINUE	The instrument reads the pressure applied and displays its value. Press <b>ENTER</b> .
	ID TAGNAME  READY	

# ADDENDUM

## FACTORY TRIM











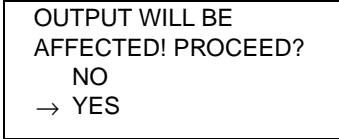

Use this option if factory setting is to be used for calibration.

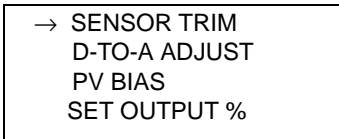
Key	Display	Comments
	<div style="border: 1px solid black; padding: 5px;">           OUTPUT WILL BE AFFECTED! PROCEED? NO → YES         </div>	This operation will cause a change in output not corresponding to the input. Be sure the control loop is in manual.  Select <i>YES</i> .
		
		
	<div style="border: 1px solid black; padding: 5px;">           → SENSOR TRIM D-TO-A ADJUST PV BIAS SET OUTPUT %         </div>	Select <i>SENSOR TRIM</i> , or select calibration option with down-arrow key and refer to the appropriate section. Press <b>ENTER</b> when done.
	<div style="border: 1px solid black; padding: 5px;">           FULL TRIM ZERO TRIM → FACTORY TRIM STATIC TRIM         </div>	Select <i>FACTORY TRIM</i> .
		
		
	<div style="border: 1px solid black; padding: 5px;">           ID TAGNAME             READY         </div>	

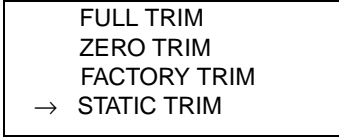
# ADDENDUM

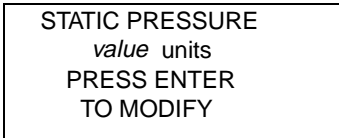
## STATIC TRIM

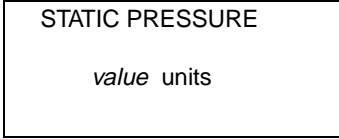
Use this option if the instrument is to be statically calibrated using a known pressure.

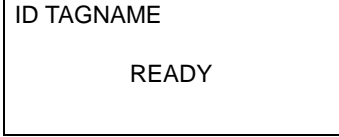
Key	Display	Comments
		<p>This operation will cause a change in output not corresponding to the input. Be sure the control loop is in manual.</p> <p>Select <i>YES</i>.</p>
		
		
		<p>Select <i>SENSOR TRIM</i>, or select calibration option with down-arrow key and refer to the appropriate section. Press <b>ENTER</b> when done.</p>
		<p>Select <i>STATIC TRIM</i>.</p>
[ 3 TIMES ]		
		
		<p>Display shows the value of the pressure measured by the 600T EN transmitter.</p>
		<p>Enter the value of the actual static pressure using the number keys.</p>
		







## ***D-to-A Adjust***

The *D-TO-A ADJUST* selection is only present when you are in the *ANALOG* communication mode. There are three methods available to adjust the four to 20 milliampere output:

- Up/Down Arrow keys.
- Meter value entry for HART devices.
- Factory DAC Trim

### ***ARROW KEY ADJUSTMENT***

Use this function to adjust the 4 to 20 milliampere output of the field device using the up and down arrow keys.

Key	Display	Comments
 	OUTPUT WILL BE AFFECTED! PROCEED? NO → YES	This operation will cause a change in output not corresponding to the input. Be sure the control loop is in manual. Select <i>YES</i> .
 	CALIBRATION SENSOR TRIM → D-TO-A ADJUST PV BIAS SET OUTPUT %	Select <i>D-TO-A ADJUST</i> .
 	D/A CAL USING → UPDOWN ARROW KEYS METER VALUE ENTRY FACTORY DAC TRIM	Select <i>UPDOWN ARROW KEYS</i> .
	ADJUST TO 4 mA  THEN HIT ENTER	Use the arrow keys to adjust the 4 mA signal.  NOTE: When increasing or decreasing the mA signal, the increments of change increase with successive depressions until the maximum level of change is reached. By changing direction you will return to the smallest increment of change. This adjustment technique speeds up the adjustment process without affecting fine adjustment.

# ADDENDUM

Key	Display	Comments
ENTER	ADJUST TO 20 mA THEN HIT ENTER	Use the arrow keys to adjust the 20 mA signal.
ENTER	ID TAGNAME READY	

## **METER VALUE ADJUSTMENT**

Use this function to adjust the four to 20 milliampere output of the field device using values from an external current meter. This method is only valid for HART devices.

Key	Display	Comments
CALIBRATE	OUTPUT WILL BE AFFECTED! PROCEED? NO → YES	This operation will cause a change in output not corresponding to the input. Be sure the control loop is in manual. Select <i>YES</i> .
↓		
ENTER		
↓	CALIBRATION SENSOR TRIM → D-TO-A ADJUST PV BIAS SET OUTPUT %	Select <i>D-TO-A ADJUST</i> .
ENTER		
ENTER	D/A CAL USING UPDOWN ARROW KEYS → METER VALUE ENTRY FACTORY DAC TRIM	Select <i>METER VALUE ENTRY</i> .



# ADDENDUM

Key	Display	Comments
ENTER	4 mA CALIBRATION: ENTER METER VALUE n.nnnn	Use the number keys to enter the current meter reading.
ENTER	20 mA CALIBRATION: ENTER METER VALUE nn.nnnn	Use the number keys to enter the current meter reading.
ENTER	ID TAGNAME  READY	

---









## PV Bias

The PV Bias calibration procedure allows you to align the "zero" of the process with the "zero" reading of the transmitter. This may be done in one of two ways:

- Apply a pressure that corresponds to the desired zero offset or bias [SET PV ZERO]
- To scale to a value different from zero, calculate the offset or bias and apply it to the 600T EN [SET PV VAL]









Key	Display	Comments
CALIBRATE	OUTPUT WILL BE AFFECTED! PROCEED? NO → YES	This operation will cause a change in output not corresponding to the input. Be sure the control loop is in manual. Select YES.
↓		
ENTER		

# ADDENDUM

Key	Display	Comments
 	<div data-bbox="453 289 786 443" style="border: 1px solid black; padding: 5px;">           CALIBRATION            SENSOR TRIM            D-TO-A ADJUST            → PV BIAS            SET OUTPUT %         </div>	<p>Select <i>PV BIAS</i>.</p> <p>If digitally configured, the <i>D-TO-A ADJUST</i> selection will not appear.</p>
		
	<div data-bbox="453 699 786 831" style="border: 1px solid black; padding: 5px;">           PV BIAS            → RESET            SET PV ZERO            SET PV VAL         </div>	<p>Use the arrow keys to scroll to the desired <i>PV BIAS</i> parameter. <i>RESET</i> removes any previously configured bias values. The following procedure is used to establish the zero offset for <i>SET PV ZERO</i>, the procedure for <i>SET PV VAL</i> is similar.</p>
 	<div data-bbox="453 894 786 1026" style="border: 1px solid black; padding: 5px;">           PV BIAS            RESET            → SET PV ZERO            SET PV VAL         </div>	<p>Apply the desired zero pressure value to the transmitter. Scroll to <i>SET PV ZERO</i> using the down arrow key and press <b>ENTER</b>.</p>
	<div data-bbox="453 1182 786 1314" style="border: 1px solid black; padding: 5px;">           PV VALUE READ:  <i>value</i> units            PRESS ENTER            TO SET PV ZERO         </div>	<p>Pressing <b>ENTER</b> calibrates the <i>PV ZERO</i> value.</p>
	<div data-bbox="453 1377 786 1472" style="border: 1px solid black; padding: 5px;">           ID TAGNAME            READY         </div>	<p><i>SET PV ZERO</i> is complete.</p>

# ADDENDUM

## Set Outputt

Key	Display	Comments
  	<div style="border: 1px solid black; padding: 5px;">           OUTPUT WILL BE            AFFECTED! PROCEED?            NO            → YES         </div>	<p>This operation will cause a change in output not corresponding to the input. Be sure the control loop is in manual.</p> <p>Select <b>YES</b>.</p>
 [ 3 TIMES ] 	<div style="border: 1px solid black; padding: 5px;">           CALIBRATION            SENSOR TRIM            D-TO-A ADJUST            PV BIAS            → SET OUTPUT %         </div>	<p>Select <b>SET OUTPUT %</b>.</p> <p>If digitally configured, the <i>D-TO-A ADJUST</i> selection will not appear.</p>
	<div style="border: 1px solid black; padding: 5px;">           SET OUTPUT %            → LOW            HIGH         </div>	<p>Select <b>LOW</b> and press <b>ENTER</b>. (Procedure for <b>HIGH</b> selection is identical).</p>
	<div style="border: 1px solid black; padding: 5px;">           OP %: nnn.nn %            PV VAL:                <i>value</i> units            Hit ENTER to set OP%         </div>	<p>Display indicates present data.</p>
	<div style="border: 1px solid black; padding: 5px;">           ENTER NEW VALUE                  <i>value</i> %         </div>	<p>Enter <b>LOW</b> value, <b>ENTER</b>.</p>
	<div style="border: 1px solid black; padding: 5px;">           ID TAGNAME            READY         </div>	

---

# Table of Contents

	<i>Page</i>
<b>SECTION 1 - INTRODUCTION .....</b>	<b>1-1</b>
STT04 DESCRIPTION .....	1-1
HOW TO USE THIS INSTRUCTION .....	1-2
NOMENCLATURE .....	1-3
REFERENCE DOCUMENTS .....	1-3
SPECIFICATIONS .....	1-4
OPTIONS AND ACCESSORIES .....	1-4
<b>SECTION 2 - DESCRIPTION AND OPERATION .....</b>	<b>2-1</b>
INTRODUCTION .....	2-1
FUNCTIONAL OPERATION .....	2-1
PHYSICAL OPERATION .....	2-1
<b>SECTION 3 - INSTALLATION .....</b>	<b>3-1</b>
INTRODUCTION .....	3-1
UNPACKING AND INSPECTION .....	3-1
SETUP AND PHYSICAL INSTALLATION .....	3-1
Charging STT04 Terminal .....	3-2
Clip Leads Cable Installation .....	3-2
DOWNLINK SOFTWARE .....	3-4
System Requirements (Personal Computer) .....	3-4
Installing DownLink Software .....	3-4
DownLink Software Practices .....	3-4
<b>SECTION 4 - OPERATING PROCEDURES .....</b>	<b>4-1</b>
INTRODUCTION .....	4-1
HOW TO USE THE PROCEDURE TABLES .....	4-1
OPERATOR/INTERFACE CONTROLS .....	4-1
INITIAL START-UP .....	4-3
SELECTING CHARACTERS FROM THE KEYPAD .....	4-4
VIEW AND SELECT CONFIGURATION .....	4-6
SEND CONFIGURATION .....	4-7
GET CONFIGURATION .....	4-8
ERASE CONFIGURATION .....	4-10
OPERATIONAL FUNCTIONS .....	4-11
Special Feature Key .....	4-12
FIX OUTPUT/CANCEL FIX OUTPUT .....	4-12
LCD SETUP .....	4-13
STANDARD CONFIGURATION .....	4-14
RESET CONFIGURATION CHANGE FLAG .....	4-15
Monitor Key Functions .....	4-16
MONITOR PRIMARY OUTPUT .....	4-16
MONITOR PRIMARY INPUT .....	4-17
MONITOR SECONDARY UNITS OUTPUT .....	4-18
TEMPERATURE FUNCTION .....	4-18
Status Check .....	4-19
Rerange Key Function .....	4-19

---

## Table of Contents (continued)

	<i>Page</i>
Options Key Functions .....	4-21
LANGUAGE .....	4-21
COMMUNICATION FORMAT .....	4-22
BATTERY .....	4-22
STT04 NAME .....	4-23
STT04 REVISION .....	4-24
UPLOADING AND DOWNLOADING CONFIGURATIONS.....	4-25
<hr/>	
<b>SECTION 5 - TROUBLESHOOTING.....</b>	<b>5-1</b>
INTRODUCTION .....	5-1
ERROR MESSAGES.....	5-1
<hr/>	
<b>SECTION 6 - REPAIR/REPLACEMENT AND UPGRADE.....</b>	<b>6-1</b>
INTRODUCTION .....	6-1
SPECIAL HANDLING GUIDELINES FOR MOS DEVICES .....	6-1
REPLACING THE BATTERY PACK .....	6-2
UPGRADES .....	6-3
DOWNLOADING AN UPGRADE TO THE STT04 TERMINAL .....	6-5
RECOMMENDED SPARE PARTS.....	6-6
<hr/>	
<b>SECTION 7 - MAINTENANCE.....</b>	<b>7-1</b>
INTRODUCTION .....	7-1
CLEANING .....	7-1
<hr/>	
<b>SECTION 8 - SUPPORT SERVICES.....</b>	<b>8-1</b>
INTRODUCTION .....	8-1
REPLACEMENT PARTS.....	8-1
SPARE PARTS LISTS .....	8-1
TRAINING .....	8-1
TECHNICAL DOCUMENTATION.....	8-1
<hr/>	
<b>APPENDIX A - SMART POSITIONER .....</b>	<b>A-1</b>
INTRODUCTION .....	A-1
CREATE/MODIFY CONFIGURATION .....	A-1
CALIBRATION.....	A-5
Output D-to-A Calibration .....	A-6
Input A-to-D Calibration .....	A-7
Manual Position Calibration.....	A-8
Automatic Position Calibration.....	A-9
SPECIAL FEATURE KEY FUNCTIONS.....	A-10
Fix Set Point/Cancel Fix Set Point.....	A-10
PID Parameters .....	A-11
Reset Totals .....	A-12
Monitor Key Functions.....	A-13

---

## Table of Contents (continued)

	<i>Page</i>
<b>APPENDIX B - EBTH TEMPERATURE TRANSMITTER.....</b>	<b>B-1</b>
INTRODUCTION.....	B-1
CREATE/MODIFY CONFIGURATION.....	B-1
CALIBRATION .....	B-5
Bench Calibration.....	B-6
D-to-A Adjust.....	B-7
ARROW KEY ADJUSTMENT.....	B-8
METER VALUE ADJUSTMENT .....	B-9
<b>APPENDIX C - EQS TEMPERATURE TRANSMITTER.....</b>	<b>C-1</b>
INTRODUCTION.....	C-1
CREATE/MODIFY CONFIGURATION.....	C-1
CALIBRATION .....	C-4
Bench Calibration.....	C-4
D-to-A Adjust.....	C-7
<b>APPENDIX D - PTH PRESSURE TRANSMITTER.....</b>	<b>D-1</b>
INTRODUCTION.....	D-1
CREATE/MODIFY CONFIGURATION.....	D-1
CALIBRATION .....	D-5
Bench Calibration.....	D-6
Rezero .....	D-8
D-to-A Adjust.....	D-8
ARROW KEY ADJUSTMENT.....	D-9
METER VALUE ADJUSTMENT .....	D-10
<b>APPENDIX E - PTS PRESSURE TRANSMITTER.....</b>	<b>E-1</b>
INTRODUCTION.....	E-1
CREATE/MODIFY CONFIGURATION.....	E-1
CALIBRATION .....	E-4
Bench Calibration.....	E-4
Rezero .....	E-7
D-to-A Adjust.....	E-8
<b>APPENDIX F - HART UNIVERSAL .....</b>	<b>F-1</b>
INTRODUCTION.....	F-1
HART UNIVERSAL CONFIGURATION .....	F-1
<b>APPENDIX G - BCN PRESSURE TRANSMITTER.....</b>	<b>G-1</b>
INTRODUCTION.....	G-1
CREATE/MODIFY CONFIGURATION.....	G-1
CALIBRATION .....	G-5
Bench Calibration.....	G-5
Rezero .....	G-8
D-to-A Adjust.....	G-9

---

## Table of Contents (continued)

	<i>Page</i>
<b>APPENDIX H - EQN TEMPERATURE TRANSMITTER .....</b>	<b>H-1</b>
INTRODUCTION .....	H-1
CREATE/MODIFY CONFIGURATION .....	H-1
CALIBRATION .....	H-4
Bench Calibration .....	H-5
D-to-A Adjust .....	H-7
<b>APPENDIX I - XM/SM/XE MAGNETIC FLOWMETER .....</b>	<b>I-1</b>
INTRODUCTION .....	I-1
CREATE/MODIFY CONFIGURATION .....	I-1
CALIBRATION .....	I-5
Empty Pipe Detector .....	I-6
D-to-A Adjust .....	I-7
<b>APPENDIX J - TBN480 CONDUCTIVITY TRANSMITTER.....</b>	<b>J-1</b>
INTRODUCTION .....	J-1
CREATE/MODIFY CONFIGURATION .....	J-1
CALIBRATION .....	J-5
Process Calibration .....	J-5
CALIBRATE PROCESS CONDUCTIVITY .....	J-6
CALIBRATE PROCESS TEMPERATURE .....	J-7
Editing the Calibration Constants .....	J-8
EDIT CONDUCTIVITY .....	J-8
EDIT TEMPERATURE .....	J-9
Reset to Factory Configuration .....	J-11
<b>APPENDIX K - TBN580 TRANSMITTER .....</b>	<b>K-1</b>
INTRODUCTION .....	K-1
CREATE/MODIFY CONFIGURATION .....	K-1
CALIBRATION .....	K-5
Process Calibration .....	K-6
Bench Calibration pH .....	K-7
Bench Calibration Temperature.....	K-10
D-to-A Adjust .....	K-11
<b>APPENDIX L - TBN581 (ORP/pION) TRANSMITTER.....</b>	<b>L-1</b>
INTRODUCTION .....	L-1
CREATE/MODIFY CONFIGURATION .....	L-1
CALIBRATION .....	L-4
Process Calibration .....	L-5
Bench Calibration (ORP/pION).....	L-6
Bench Calibration (mV) .....	L-8
D-to-A Adjust .....	L-9
<b>APPENDIX M - TZID/AZH POSITIONER .....</b>	<b>M-1</b>
INTRODUCTION .....	M-1
CREATE/MODIFY CONFIGURATION .....	M-1
CALIBRATION .....	M-5
Autostroke Calibration .....	M-5
Manual Range Adjustment .....	M-6
Lever Zero Position .....	M-7

---

## Table of Contents (continued)

	<i>Page</i>
Spring Action Actuator .....	M-8
SPECIAL FEATURE .....	M-9
Device Information .....	M-9
Control Parameters .....	M-10
Characteristic Curve.....	M-12
Operating Mode .....	M-13
Device Self Test.....	M-14
Master Reset.....	M-15
ERROR MESSAGES (TZID/AZH).....	M-16

---

### **APPENDIX N - TB82 TRANSMITTER .....** **N-1**

INTRODUCTION .....	N-1
CREATE/MODIFY CONFIGURATION.....	N-1
CALIBRATION .....	N-4
One-point Calibration .....	N-4
Two-point Calibration .....	N-6
Temperature Calibration .....	N-8
Edit Calibration .....	N-9
Reset Calibration.....	N-10
Output D/A Calibration .....	N-11
SPECIAL FEATURE .....	N-12
Sensor Data .....	N-12
HART Special Feature .....	N-13
Sensor Setup .....	N-13
Master Reset.....	N-14
Number of Response Preambles.....	N-15
Reset Configuration Change Flag.....	N-16
PROBLEM AND ERROR CODES (TB82).....	N-16

---

### **APPENDIX O - STT04 DOWNLINK SOFTWARE .....** **O-1**

INTRODUCTION .....	O-1
SECURITY .....	O-1
Starting the Password Program .....	O-1
Adding a User .....	O-1
Deleting a User .....	O-3
Bypass .....	O-4
Disable Password Security .....	O-4
Enable Password Security .....	O-4
View User Names .....	O-4
USING DOWNLINK SOFTWARE .....	O-5
Start.....	O-6
Database.....	O-6
NEW.....	O-6
OPEN .....	O-7
EXIT .....	O-7
View Configurations .....	O-7
CONNECTED STT04 .....	O-7
DATABASE FILES.....	O-8
Transfer Configurations.....	O-8
UPLOAD FROM STT04.....	O-9
DOWNLOAD TO STT04 .....	O-10
Utilities.....	O-11
TEST COMMUNICATION.....	O-11



## Table of Contents (continued)

	<i>Page</i>
CHANGE STT04 NAME.....	O-12
Special Advanced.....	O-13
REPORT DIAGNOSTICS.....	O-13
UPGRADE FIRMWARE.....	O-13
UPGRADE BOOT CODE.....	O-13
SET COM PORT.....	O-13

---

### **APPENDIX P - AS800 PRESSURE TRANSMITTER..... P-1**

INTRODUCTION.....	P-1
CREATE/MODIFY CONFIGURATION.....	P-1
CALIBRATION.....	P-5
Input A/D.....	P-6
D-to-A Adjust.....	P-7
ARROW KEY ADJUSTMENT.....	P-7
METER VALUE ADJUSTMENT.....	P-8
Zero Trim Calibration.....	P-9
Temperature Calibration.....	P-10

---

### **APPENDIX Q - 600T & 600T EN PRESSURE TRANSMITTER..... 1-13**

INTRODUCTION.....	1-13
CREATE/MODIFY CONFIGURATION.....	1-13
CALIBRATION.....	1-17
Sensor Trim.....	1-18
FULL TRIM.....	1-18
ZERO TRIM.....	1-19
FACTORY TRIM.....	1-20
STATIC TRIM.....	1-21
D-to-A Adjust.....	1-22
ARROW KEY ADJUSTMENT.....	1-22
METER VALUE ADJUSTMENT.....	1-23
PV Bias.....	1-24
Set Output %.....	1-26

---

## List of Figures

<i>No.</i>	<i>Title</i>	<i>Page</i>
1-1.	STT04 Smart Transmitter Terminal.....	1-1
2-1.	Analog Point-to-Point Communications Wiring.....	2-2
2-2.	ABB Digital Field Bus and HART Wiring.....	2-2
3-1.	Receptacle Locations.....	3-2
3-2.	Analog Point-to-Point Wiring.....	3-3
3-3.	Digital Field Bus and HART Wiring.....	3-4
6-1.	Internal Component Locations.....	6-3
A-1.	Configuration Flowchart (AVS).....	A-1
A-2.	Calibration Flowchart (AVS).....	A-5
B-1.	Configuration Flowchart (EBTH).....	B-1
B-2.	Calibration Flowchart (EBTH).....	B-5
C-1.	Configuration Flowchart (EQS).....	C-1
C-2.	Calibration Flowchart (EQS).....	C-5

## List of Figures (continued)

<b>No.</b>	<b>Title</b>	<b>Page</b>
D-1.	Configuration Flowchart (PTH).....	D-1
D-2.	Calibration Flowchart (PTH).....	D-5
E-1.	Configuration Flowchart (PTS).....	E-1
E-2.	Calibration Flowchart (PTS).....	E-5
F-1.	Configuration Flowchart (HART).....	F-1
G-1.	Configuration Flowchart (BCN).....	G-1
G-2.	Calibration Flowchart (BCN).....	G-5
H-1.	Configuration Flowchart (EQN).....	H-1
H-2.	Calibration Flowchart (EQN).....	H-5
I-1.	Configuration Flowchart (XM/SM/XE Mag Flow).....	I-1
I-2.	Calibration Flowchart (XM/SM/XE Mag Flow).....	I-6
J-1.	Configuration Flowchart (TBN480).....	J-1
J-2.	Calibration Flowchart (TBN480).....	J-5
K-1.	Configuration Flowchart (TBN580).....	K-1
K-2.	Calibration Flowchart (TBN580).....	K-5
L-1.	Configuration Flowchart (TBN581).....	L-1
L-2.	Calibration Flowchart (TBN581).....	L-5
M-1.	Configuration Flowchart (TZID/AZH).....	M-1
M-2.	Calibration Flowchart (TZID/AZH).....	M-5
N-1.	Configuration Flowchart (TB82).....	N-1
N-2.	Calibration Flowchart (TB82).....	N-4
O-1.	Password Key Screen.....	O-2
O-2.	Add User Dialog Box.....	O-2
O-3.	DownLink Software Screen.....	O-6
O-4.	Summary of STT04 Configurations.....	O-9
O-5.	Replace Configuration File Dialog.....	O-10
P-1.	Configuration Flowchart (AS800).....	P-1
P-2.	Calibration Flowchart (AS800).....	P-5

## List of Tables

<b>No.</b>	<b>Title</b>	<b>Page</b>
1-1.	STT04 Terminal Device Support.....	1-2
1-2.	STT04 Nomenclature.....	1-4
1-3.	Reference Documents.....	1-4
1-4.	Glossary of Terms and Abbreviations.....	1-5
1-5.	STT04 Terminal Specifications.....	1-5
3-1.	System Requirements.....	3-4
4-1.	Keypad Functions.....	4-2
4-2.	Languages.....	4-25
5-1.	STT04 Error Messages for ABB FSK Devices.....	5-1
5-2.	STT04 Error Messages for HART Devices.....	5-8
6-1.	Upgrade Languages.....	6-5
6-2.	List of Spare Parts.....	6-5
M-1.	Error Messages for TZID/AZH Positioner.....	M-16
N-1.	Problem Codes of TB82 Transmitter.....	N-17
N-2.	Error Codes of the TB82 Transmitter.....	N-23
O-1.	User Level Accessibility.....	O-3
O-2.	Software Function Summary.....	O-5

# Read First

---

## WARNING

### INSTRUCTION MANUALS

Do not install, maintain or operate this equipment without reading, understanding and following the proper factory-supplied instructions and manuals, otherwise injury or damage may result.

### RETURN OF EQUIPMENT

All equipment being returned to the factory for repair must be free of any hazardous materials (acids, alkalis, solvents, etc.). A Material Safety Data Sheet (MSDS) for all process liquids must accompany returned equipment. Contact the factory for authorization prior to returning equipment.

Read these instructions before starting installation;  
save these instructions for future reference.

## Contacting the Factory . . .

Should assistance be required with any of the company's products, contact the following:

### Telephone:

**24-Hour Call Center  
1-800-HELP-365**

### E-Mail:

**[ins.techsupport@us.abb.com](mailto:ins.techsupport@us.abb.com)**

---

# SECTION 1 - INTRODUCTION

---

## STT04 DESCRIPTION

The STT04 Smart Transmitter Terminal is a battery powered, portable communication device that configures, calibrates, monitors, modifies, troubleshoots, and verifies the operation of HART devices and ABB smart devices from remote locations (Fig. 1-1).

The STT04 Smart Transmitter Terminal consists of an LCD display, key pad (32 keys) and an RS-232-C port for personal computer communications. The terminal comes with a clip lead cable, battery charger and an optional carrying case.

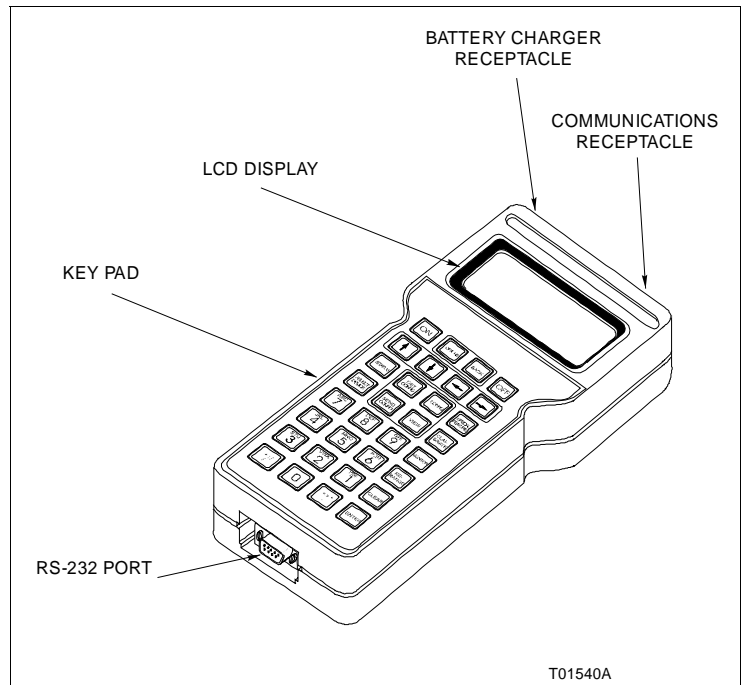

Figure 1-1. STT04 Smart Transmitter Terminal

The STT04 terminal can operate for approximately six days before needing a charge. Each terminal includes a battery charger.

The STT04 terminal supports HART devices and ABB Digital FSK devices. Refer to Table 1-1 for a list of devices.

Table 1-1. STT04 Terminal Device Support

Type	Device
HART	EBTH
	HART Universal <sup>1</sup>
	PTH
	TB82
	TZID/AZH
ABB FSK	AVS
	BCN
	EQN
	EQS
	PTS
	TBN480
	TBN580
	TBN581
	XE/SM/XE

**NOTE:**

1. Used to communicate with unsupported HART devices.

---

## HOW TO USE THIS INSTRUCTION

Read this instruction completely through in sequence. It is important to become familiar with the entire contents of this instruction before using the STT04 terminal. After reading:

1. Perform the steps in **Section 3**. Make sure all hardware is installed properly before connecting the STT04 terminal.
2. Refer to **Section 4** after installation is complete for information on the use of the STT04 terminal.
3. Refer to the appropriate appendix when configuring and calibrating a field device.
4. Each device has a configuration worksheet located at the back of this instruction. Use the worksheets to keep a hard copy record of the device configuration.

This document uses the following text conventions:

- Bold Italic Text*** Refers to specific section names through out this instruction.
- Display Item* Shows display items as they appear on the STT04 terminal.
- KEY** Shows the actual keys that are pressed when in procedural steps.
- nnn** Indicates numeric values in a display.

**NOMENCLATURE**

Table 1-2 lists the nomenclature selections for the STT04 terminal.

Table 1-2. STT04 Nomenclature

Position	1	2	3	4	5	6	
<b>Type</b>	<b>S</b>	<b>T</b>	<b>T</b>	<input type="checkbox"/>	<input type="checkbox"/>	<input type="checkbox"/>	<b>Smart Transmitter Terminal</b>
				0			<b>Option</b> Terminal only
				1			Terminal with soft carrying case
					4		<b>Revision level</b> Revision level
							<b>Keypad insert</b> E English F French S Spanish

**REFERENCE DOCUMENTS**

Table 1-3 lists the instructions related to the STT04 terminal.

Table 1-3. Reference Documents

Number	Document
I-E21-31	Smart Electronic Pressure Transmitter BCN1
I-E21-32	Smart Electronic Pressure Transmitter BCN2/3/4/5/6/8
I-E21-37	Smart Electronic Level Transmitter BCN7
I-E21-50-1	Platinum Standard Series Smart Pressure Transmitter PTSD
I-E21-50-2	Platinum Standard Series Smart Level Transmitter PTSDL
PN25053	Platinum Standard Series Smart Pressure Transmitter PTSP
PN25051	Platinum Standard Series HART Pressure Transmitter PTHD
I-E21-54-2	Platinum Standard Series HART Level Transmitter PTHDL
PN25052	Platinum Standard Series HART Pressure Transmitter PTHP
I-E51-79	Smart Temperature Transmitter EQN
I-E51-80-001	Platinum Standard Series Smart Temperature Transmitter EQS
I-E67-38	Smart pH/ORP Specific Ion Transmitter Series TBN580/581
I-E67-42	Smart Conductivity Transmitter Series TBN480
I-E96-302	Field Bus Module IMFBS01
WBPEEU110503A0	Platinum Standard Series HART Temperature Transmitter EBTH
WBPEEU120752A0	Smart Positioner AVS
WBPEEU1520002A0	Advantage Series pH/ORP/pION Transmitter TB82
42/18-54-EN	TZID/AZH Positioner
PN 25041	Magnetic Flow Meter XM-Series

**SPECIFICATIONS**

Table 1-4 lists the performance specifications of the STT04 terminal.

*Table 1-4. STT04 Terminal Specifications*

Property	Characteristic/ Value
Display format	
Type	LCD
Number of rows	4
Characters per row	20
Configuration storage capacity	100 configurations
Keyboard type	Tactile feedback embossed membrane; 32 keys
Clip Leads Cable length	1.8 m (5 ft 10 in.)
Temperature limits	
Operating	-10° to 60°C (14° to 140°F)
Storage	-20° to 70°C (-4° to 158°F)
Humidity limits	95%, noncondensing
Batteries	
Type	AA NiCd rechargeable
Run time	6 days (approximately)
Charging time	2.8 hours
Weight	635 g (22.4 oz)
Dimensions (HxWxD)	200 x 108 x 44 mm (7.875 x 4.25 x 1.75 in)
Case material	Plastic, polycarbonate (Lexan 940® or equivalent)
Agency certifications <sup>1</sup>	Factory Mutual (FM) approval and Canadian Standards Association (CSA) certifications in the following categories:  Nonincendive: Class I; Division 2; Groups A, B, C, D  Intrinsically Safe: Class I; Division 1; Groups A, B, C, D

**NOTE:**

1. Hazardous location approvals for use in flammable atmospheres are for ambient conditions of -25° to 40°C (-13° to 104°F), 86 to 106 kPa (12.5 to 15.7 psi) with a maximum oxygen concentration of 21 percent.

SPECIFICATIONS SUBJECT TO CHANGE WITHOUT NOTICE

**OPTIONS AND ACCESSORIES**

The STT04 has a nomenclature option for a carrying case, refer to Table 1-2 for nomenclature details. Spare parts are recommended to be kept on hand to minimize down time, refer to **REPAIR/REPLACEMENT AND UPGRADE** in Section 6 for spare parts information.

---

## SECTION 2 - DESCRIPTION AND OPERATION

---

### *INTRODUCTION*

This section describes the operational modes of the STT04 Smart Transmitter Terminal and contains diagrams of the wiring connections between the field device and the terminal.

---

### *FUNCTIONAL OPERATION*

The STT04 terminal operates with a field device by attaching clip leads from the terminal to the signal wires of the field device. Communication occurs over the signal wires.

The STT04 terminal and field devices communicate by using any of the following communication methods:

**HART** A slow speed (1,200 baud) communication standard established by HART communications foundation (specification 5.0). The communication signal is a high frequency AC waveform with a zero DC average. It has no effect on the transmitter output. This communications method provides exceptional noise immunity.

**ABB FSK** High speed (9,600 baud) frequency shift keying is a form of frequency modulation used for digital communication. The communication signal is a high frequency AC signal with a DC average of zero. Therefore, digital communication and process variable output can occur simultaneously. Communicates with up to eight devices when interfacing the ABB digital field bus.

---

### *PHYSICAL OPERATION*

The STT04 terminal connects to the field device anywhere there is access to the signal leads of the transmitter. The STT04 terminal must be connected between the device and the 250 ohm resistance. The clip leads connect across the signal leads independent of signal direction or polarity. Refer to Figures [2-1](#) and [2-2](#).

Batteries and length of charge can be operated with the charger connected.



## DESCRIPTION AND OPERATION

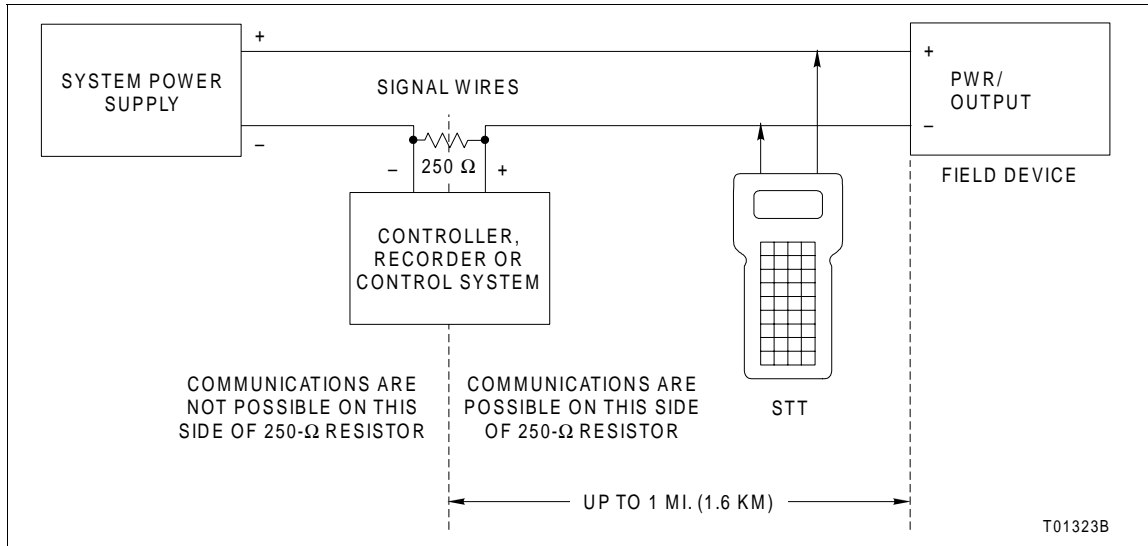

Figure 2-1. Analog Point-to-Point Communications Wiring

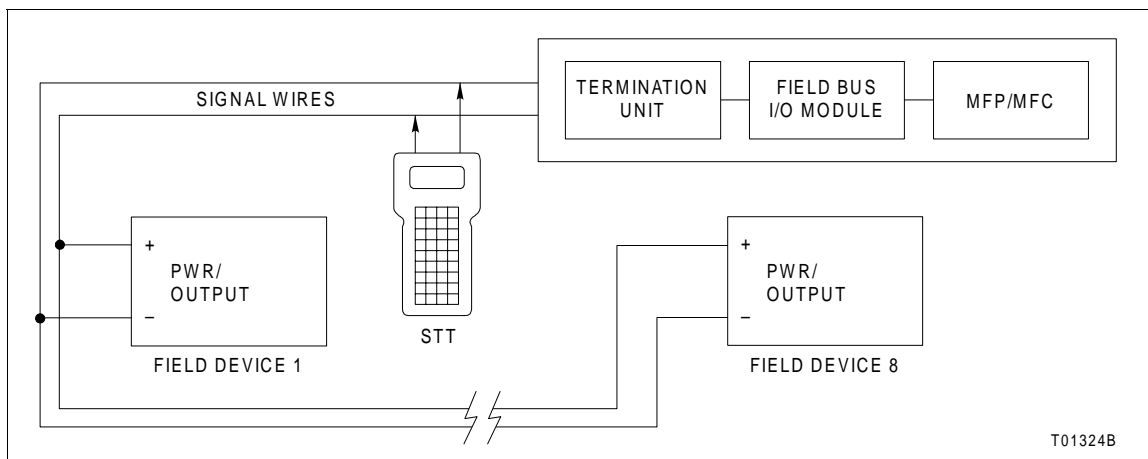

Figure 2-2. ABB Digital Field Bus and HART Wiring

---

## SECTION 3 - INSTALLATION

---

### *INTRODUCTION*

This section provides procedures that make the STT04 terminal operational.

---

### *UNPACKING AND INSPECTION*

Before unpacking, carefully examine the exterior of the shipping container for evidence of in-transit damage. Inspect for punctures, tears or other damage that penetrates the outer container, and for evidence of water damage.

The shipping package contains the following:

- STT04 Smart Transmitter Terminal.
- Clip leads cable.
- DownLink Software CD (STT04 firmware or later).
- STT04 carrying case (optional).

**NOTE:** If STT04 firmware is A.0, DownLink Software is not included with the firmware. Contact the nearest ABB sales office for software availability.

Examine the exterior of the STT04 terminal for physical defects.

If storing the terminal prior to operation, pack in the original container, if possible. Store in an area free of extremes in temperature and humidity.

---

### *SETUP AND PHYSICAL INSTALLATION*

The only installation task is the connection of the provided clip leads. Otherwise, the STT04 terminal comes fully assembled and operational.

### Charging STT04 Terminal

#### WARNING

**To prevent ignition of a hazardous atmosphere, batteries must only be charged in an area known to be nonhazardous.**

Periodically the battery unit requires charging. Use the battery charger, ABB part number 1949616?A for North American 60 Hz plug configuration. Contact your local ABB sales office for international plug configurations.

With a full charge, the STT04 terminal can operate for approximately six days before needing a charge.

To charge the STT04 terminal:

1. Insert the male end of the battery charger into the battery charger receptacle on the STT04 terminal (Fig. 3-1).
2. Plug the charger into a 120 VAC, 50/60 Hz outlet. Contact your local ABB sales office for international plug configurations.
3. Allow the terminal to charge at least one hour before operating. A full charge takes approximately 2.8 hours. The terminal can operate while recharging is in progress.

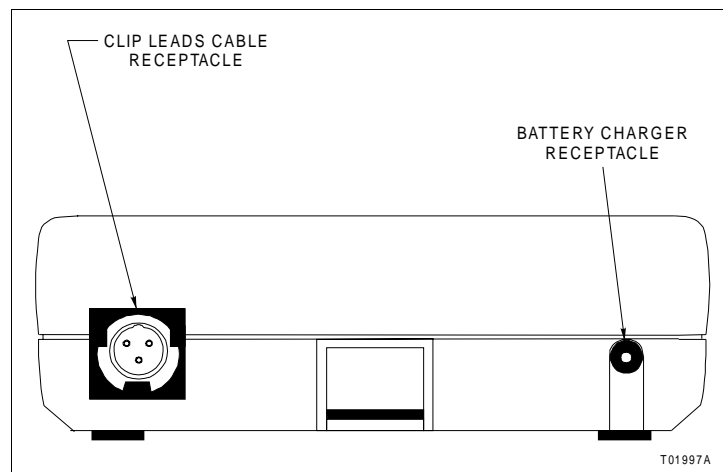

Figure 3-1. Receptacle Locations

### Clip Leads Cable Installation

The STT04 terminal communicates with a field device by attaching the clip leads from the terminal to the signal wires of the field device.

To install the clip leads cable:

1. Insert the female end of the clip leads cable connector into the clip leads cable receptacle on the terminal with the button facing up (Fig. 3-1). Make sure the connector is fully engaged.
2. Connect the clip leads to the signal wires between the device and the 250 ohm resistance. The clip leads connect across the signal leads independent of signal direction or polarity. Refer to Figures 3-2 and 3-3.

To remove the clip leads cable:

1. Fully depress and hold in the button on the top of the clip leads cable connector.
2. Firmly, but carefully pull the connector from the receptacle.

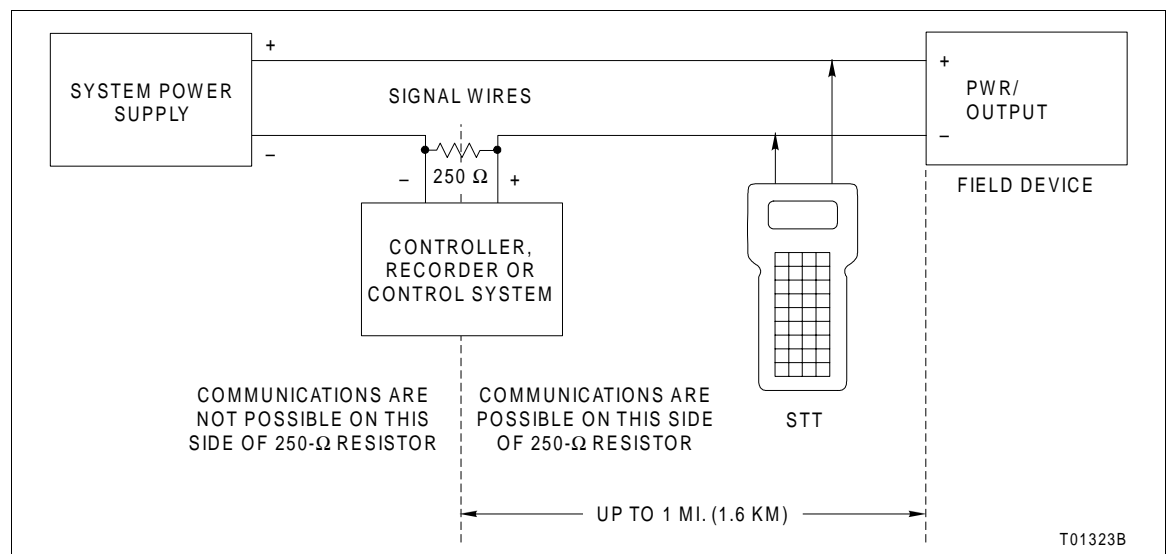

Figure 3-2. Analog Point-to-Point Wiring

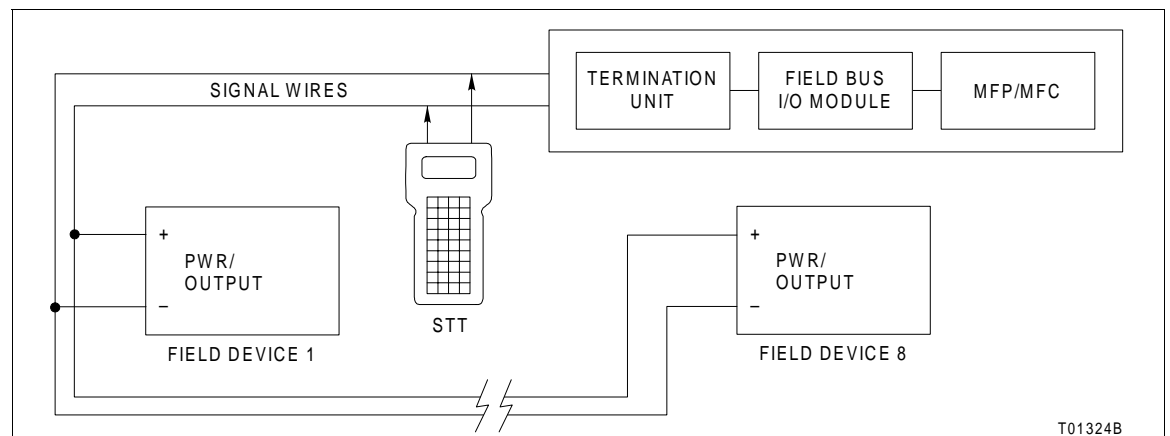

Figure 3-3. Digital Field Bus and HART Wiring

## DOWNLINK SOFTWARE

---

The DownLink Software is a Windows®-based application that is used to interface the STT04 terminal with a personal computer. The DownLink Software provides the STT04 terminal with the ability to:

**Download firmware upgrades to the STT04**

When enhancements are made to the STT04 firmware, users can access the latest revision via the internet and then download it to the STT04 terminal from a personal computer.

**Upload and download configurations on a PC**

Configurations can be saved from the STT04 terminal to a personal computer for storage where they can be retrieved when needed.

---

### System Requirements (Personal Computer)

Before attempting to install the DownLink Software on a personal computer, be sure the PC has at least the minimum requirements listed in Table 3-1.

Table 3-1. System Requirements

System Attribute	Requirements	
	Minimum	Recommended
Processor	486-based	Pentium®-based
Hard disk space	8 Mb	16 Mb
Operating system and RAM memory		
Windows 95	16 Mb	32 Mb
Windows NT® 4.0 or greater	16 Mb	32 Mb

---

### Installing DownLink Software

1. Insert the CD.
2. Click *Start* and select *Run*.
3. Click in *Open* and type CD Drive letter:\setup and click *OK*.
4. Follow the installation prompts as they appear.

---

### DownLink Software Practices

**WARNING**

When using the DownLink Software application, it is important to name each STT04 terminal that will be used with a particular personal computer. This is important to avoid database problems. Each STT04 terminal should have it's own database that will carry a name linking it to the corresponding STT04 terminal.

---

# SECTION 4 - OPERATING PROCEDURES

---

## *INTRODUCTION*

This section covers the functions of the various keys on the STT04 Smart Transmitter Terminal. Step-by-step procedures illustrate each function.

This section covers:

- Keypad function table.
- Send configurations.<sup>1</sup>
- Get configurations.<sup>1</sup>
- View configurations.<sup>1</sup>
- Erase configurations.<sup>1</sup>
- Change working configurations.<sup>1</sup>
- Operational functions:
  - Special feature.
  - Monitor.
  - Status.
  - Rerange.
  - Options.

**NOTE:** 1. These functions apply to all transmitters. The procedures are not duplicated for each transmitter type. The 600T HART transmitter is used in the example procedures.

The creation and modification of configurations and calibrations are device specific and therefore are covered in the device specific appendices of this instruction.

---

## *HOW TO USE THE PROCEDURE TABLES*

Procedures for each of the functions are presented in tables having three columns: Key, Display, and Comments. The tables read from left to right. When the key shown is pressed, the screen shown directly to the right in the display column appears on the terminal screen. The comment pertains to that screen. Use the procedure tables to step through the functions.

---

## *OPERATOR/INTERFACE CONTROLS*

Table 4-1 provides a description of functions for the keys on the STT04 terminal.

**NOTE:** The configure, view, select device and options keys function without a field device connected to the STT04 terminal. The other functions are locked out until a field device is connected to the terminal.

## OPERATING PROCEDURES

Table 4-1. Keypad Functions













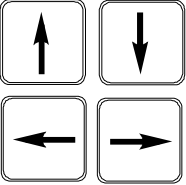
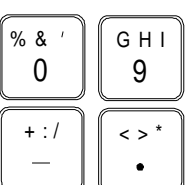



Key	Function
	Powers the unit up and displays the STT04 firmware revision level.
	Turns power off. Stored configurations remain in internal memory. The terminal will shut itself off after 15 minutes of idle operation.
	Scrolls through menus and selects functions.
	Inputs values into the terminal. Includes digits 0 through 9, ASCII characters A through Z, signs, and punctuation.
	Completes an input or a selection.
	<ol style="list-style-type: none"> <li>1. Inputs a new configuration into the STT04 internal memory.</li> <li>2. Modifies an existing configuration.</li> <li>3. Erases an existing configuration from the terminal memory.</li> </ol>
	Retrieves, views and optionally saves the configuration of the selected field device.
	Sends a configuration from the STT04 terminal to a selected field device.
	Steps through various calibration procedures (dependent on the selected field device).
	Monitors primary input or output, secondary output, ambient temperature of the selected field device, and other variables.
	Displays field device status based on results of continuous self-diagnostics.
	<ol style="list-style-type: none"> <li>1. Changes engineering units.</li> <li>2. Sets lower and upper range values of primary and secondary units.</li> <li>3. Changes the output dampening.</li> </ol>

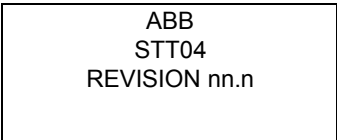

Table 4-1. Keypad Functions (continued)

Key	Function
	<ol style="list-style-type: none"> <li>1. Sets output to a fixed value.</li> <li>2. Cancels a fixed output.</li> <li>3. Sets up LCD - select display units to be displayed on the field device LCD.</li> <li>4. Changes device configuration to the standard configuration (PTS only).</li> </ol> <p><b>NOTE:</b> For special feature functions refer to the appropriate Appendix.</p>
	Escapes the current function and returns the display to the <i>READY</i> condition.
	Selects and changes working configurations and field devices (if connected).
	Steps through the selections of the working configuration. Views a configuration, but does not allow modifications to be made.
	<ol style="list-style-type: none"> <li>1. Sets the language of the display screens.</li> <li>2. Sets the communication format.</li> <li>3. Displays the amount of charge left on the battery pack.</li> <li>4. Displays the STT04 name.</li> </ol>
	Returns to a previous screen during configuration, calibration, rerange, etc.

**INITIAL START-UP**

The sequence of screens described will appear when the STT04 terminal is powered up for the first time and is not connected to a field device, or when a configuration is created and stored in the terminal.

**NOTE:** The terminal (if not configuring or calibrating) will automatically shut itself off after approximately 15 minutes without operator interaction.

Key	Display	Comments
		Displays the firmware revision of the STT04 terminal.
		STT04 terminal prompts for a communication format. Select a communication format using the up or down key. After selecting communications, the terminal scans for devices of the selected format. Select the correct communication format.



## OPERATING PROCEDURES







Key	Display	Comments
ENTER	SCANNING FOR SMART FIELD DEVICES	STT04 terminal attempting to communicate with a field device. If the terminal is connected to a field device, the <i>READY</i> screen appears. If the terminal is not connected to a device, it searches for configurations that have been stored.
	NO SMART FIELD DEVICE RESPONDING	Appears only if field devices are not connected. The STT04 terminal searches for configurations in its internal memory. If configurations are present, a list of ID tag names appears.
ENTER	NO ANALOG DEV FOUND. POLL FOR DIGITAL DEV? → NO YES	Only appears if <i>HART</i> is selected for communication format and no analog field devices are connected.  Choose <i>YES</i> to poll for digital devices.
	CHOOSE A TAG READY	A configuration can be created. Refer to the appendices at the back of this instruction for configuration procedures for all supported devices.

### SELECTING CHARACTERS FROM THE KEYPAD

Character entry into the STT04 terminal is done using the numeric keypad. The following example details how character entry is performed.

Key	Display	Comments
CONFIG	CONFIGURATION → NEW MODIFY ERASE	Select <i>NEW</i> to create a configuration.
ENTER	DEVICE TYPE → HART	Select <i>HART</i> .
ENTER	TRANSMITTER TYPE → PTS EQS BCN EQN AVS TBN480	Select <i>600T</i> .

### SELECTING CHARACTERS FROM THE KEYPAD

Key	Display	Comments
	<pre>STT04 CONFIGURATION [ _ ] ←PREVIOUS     NEXT→</pre>	<p>For this example, use the configuration ID tag name of <i>W1</i>.</p>
	<pre>STT04 CONFIGURATION [ 2 ] ←PREVIOUS     NEXT→</pre>	<p>Press the 2 key and a 2 appears in the first character place.</p>
	<pre>STT04 CONFIGURATION [ V ] ←PREVIOUS     NEXT→</pre>	<p>Press the 2 key again and the letter <i>V</i> appears in the first character place.</p>
	<pre>STT04 CONFIGURATION [ W ] ←PREVIOUS     NEXT→</pre>	<p>Press the 2 key again and the letter <i>W</i> appears in the first character place.</p>
	<pre>STT04 CONFIGURATION [ W_ ] ←PREVIOUS     NEXT→</pre>	<p>The cursor is in the second character position.</p>
	<pre>STT04 CONFIGURATION [ W1 ] ←PREVIOUS     NEXT→</pre>	<p>Press the 1 key and the number 1 appears in the second character position.</p>
	<pre>SELECT MODE: → ANALOG DIGITAL</pre>	<p>Press <b>CLEAR</b> and abort this configuration.</p>

**VIEW AND SELECT CONFIGURATION**



Use the view function key to:

- Review the parameters of a configuration.
- Select a new working configuration.

Key	Display	Comments
	<div style="border: 1px solid black; padding: 5px; width: fit-content;">                     ID TAGNAME                       READY                 </div>	The STT04 terminal is ready for operation. The <i>ID TAGNAME</i> in the left corner is either the configuration name or device name.
<div style="border: 1px solid black; border-radius: 5px; padding: 5px; width: fit-content; margin: 5px auto;">VIEW</div>	<div style="border: 1px solid black; padding: 5px; width: fit-content;">                     STT04 CONFIGURATION                      2. [CONFIGNAME2]                      3. CONFIGNAME3                      4. CONFIGNAME4                 </div>	Displays configurations. Use the arrow keys to select the desired configuration. The brackets indicate the selected configuration.
<div style="border: 1px solid black; border-radius: 5px; padding: 5px; width: fit-content; margin: 5px auto;">↓</div>		<p><b>NOTE:</b> To more quickly scroll through configurations (three at a time) press the left arrow key to scroll down or the right arrow key to scroll up.</p>
<div style="border: 1px solid black; border-radius: 5px; padding: 5px; width: fit-content; margin: 5px auto;">ENTER</div>		Press <b>ENTER</b> continuously while reviewing the parameters, until the <i>READY</i> screen appears.
<p style="text-align: center;">.</p> <p style="text-align: center;">.</p> <p style="text-align: center;">.</p>		<p><b>NOTE:</b> To select a configuration without reviewing all the parameters, press <b>CLEAR</b> after selecting the configuration.</p>
<div style="border: 1px solid black; border-radius: 5px; padding: 5px; width: fit-content; margin: 5px auto;">ENTER</div>	<div style="border: 1px solid black; padding: 5px; width: fit-content;">                     ID TAGNAME2                       READY                 </div>	The new working configuration name appears in the upper left portion of the screen.

**SEND CONFIGURATION**

Use the send configuration function key to send a configuration from the terminal to a connected device.

Key	Display	Comments
	<div style="border: 1px solid black; padding: 5px;">                     STT04 CONFIGURATION                      1. [CONFIGNAME]                      2. CONFIGNAME2                      3. CONFIGNAME3                 </div>	A complete list of configurations display (three per screen). To select from the existing configurations, use the arrow keys to scroll through the list.
	<div style="border: 1px solid black; padding: 5px;">                     SELECT TRANSMITTER                      [nnnnnnnnnnnnnnnnnnnn]                 </div>	<b>NOTE:</b> To more quickly scroll through configurations (three at a time) press the left arrow key to scroll down or the right arrow key to scroll up.  Displays the ID tag name of the selected transmitter.
	<div style="border: 1px solid black; padding: 5px; text-align: center;">                     SENDING                      CONFIGURATION                 </div>	
	<div style="border: 1px solid black; padding: 5px;">                     ID TAGNAME                       READY                 </div>	Configuration was sent successfully.

# OPERATING PROCEDURES

## GET CONFIGURATION



Use the get configuration function key to view and save the configuration of a connected field device. Get configuration requires that the STT04 terminal be connected to a device.

**NOTE:** This procedure is similar for all device types. It is intended as a general guide for this function. Variances occur based on device type.

Key	Display	Comments
GET CONFIG	SELECTED CONFIGURATION [nnnnnnnnnnnnnnnnnnnn]	The name within the brackets is the working configuration.
ENTER	STORE THIS CONFIGURATION? NO → YES	The option to save the configuration in the STT04 terminal internal memory is presented. When the configuration is stored, exit the function by pressing <b>CLEAR</b> .
↓		<b>NOTE:</b> A maximum of 100 configurations can be stored in the STT04 terminal.
ENTER	CONFIG ID TAGNAME DEVICE MFR: ABB	The device ID tag name and manufacturer is displayed for HART transmitters only.
ENTER	CONFIG ID TAGNAME TYPE: 600T MODE: DIGITAL CHANNEL: 2	Displays the 14 character ID tag name of the connected device. The <i>TYPE</i> field displays the device type. If <i>ANALOG</i> mode, the <i>CHANNEL</i> field will not show.
ENTER	OUTPUT TYPE: LINEAR → SQUARE ROOT 3/2 FLOW MODE	Indicator points to the configured output type. <b>NOTE:</b> Use <b>BACK</b> to return to any screen during configuration.
ENTER	OUTPUT ACTION: → NORMAL REVERSE	Configured output action is displayed.

Key	Display	Comments
ENTER	DAMPING (0 - 32 SEC)  6.00 SEC	Damping value is displayed to the nearest hundredth of a second.
ENTER	LOWER RANGE VAL. nn.nn UNITS UPPER RANGE VAL. nn.nn UNITS	Lower and upper range values are displayed.
ENTER	INITIALIZE MODE: → LOW HIGH	Indicator points to the configured initialization mode.
ENTER	FAIL MODE: → LOW HIGH LAST	Indicator points to the configured fail mode.
ENTER	SECONDARY L. R. nn.nn UNITS SECONDARY U. R. nn.nn UNITS	Secondary upper and lower range values are displayed to the nearest hundredth.
ENTER	LOWER TEMP ALARM -50.00°C UPPER TEMP ALARM 120.00°C	Only applies if interfacing a PTS, PTH, EQS or EBTH transmitter. The upper and lower range temperature alarm values are shown as configured.
ENTER	MESSAGE:  ←PREVIOUS      NEXT→	This display appears when configuring HART transmitters only. A message of up to 32 characters can be entered.
ENTER	DESCRIPTOR:  ←PREVIOUS      NEXT→	This display appears when configuring HART transmitters only. A descriptor of up to 16 characters can be entered.





## OPERATING PROCEDURES

Key	Display	Comments
	DATE: DAY: nn MONTH: nn YEAR: nn	This display appears when configuring HART transmitters only. Two digits can be entered for the day, month and year.
	ID TAGNAME READY	Configuration ID tag name just configured will be in the upper left corner if the configuration was saved. This becomes the working configuration.

### ERASE CONFIGURATION

Use this function to erase a configuration from the STT04 terminal memory.

**NOTE:** This procedure is identical for all device types.

Key	Display	Comments
	CONFIGURATION NEW MODIFY → ERASE	Select <i>ERASE</i> .
		
		
	STT04 CONFIGURATION 1. FT101 2. FT103 3. LT 106	Displays the stored configurations. Use the scroll keys to select a stored configuration to view. The ID tag name that is bracketed indicates it is selected for deletion.
	ERASE ID TAGNAME → NO YES	<b>NOTE:</b> To more quickly scroll through configurations (three at a time) press the left arrow key to scroll down or the right arrow key to scroll up.  To erase the selected configuration, use the down arrow key to move the pointer to <i>YES</i> , then press <b>ENTER</b> .  <b>NOTE:</b> To return to the <i>READY</i> screen without erasing a configuration, press <b>CLEAR</b> .

Key	Display	Comments
	<div style="border: 1px solid black; padding: 10px; margin: 0 auto; width: fit-content;">                     ID TAGNAME                       READY                 </div>	

To completely erase the smart terminal internal memory of stored configurations:

1. Turn the STT04 terminal **OFF**.
2. Press and hold the minus ( - ) and enter keys down simultaneously.
3. Turn the STT04 terminal **ON**. A confirmation message appears confirming the deletion:

\* ERASING CONFIGS \*  
- COMPLETE -

4. Turn the STT04 **OFF** and then **ON** again to access a *READY* screen.

---

**OPERATIONAL FUNCTIONS**

The operational functions of the STT04 terminal apply to all transmitter types. The following functions are covered in this section:

- Special feature key.
- Monitor key.
- Status key.
- Rerange.
- Option key.

**NOTE:** A series of *ns* in the display portion of the function procedures indicate that an alphanumeric character can be displayed or entered in that position.



**Special Feature Key**

The special feature key has different functions for each transmitter. Reference the specific product instruction for special feature information. An example of the PTS transmitter is explained in this section.

Use the special feature key to:

- Fix output and cancel fix output.
- Set up the LCD.
- Access the standard configuration.



**NOTES:**

1. A device must be connected to the terminal in order to use these functions.
2. The special feature functions for positioner vary from the standard functions. For details, refer to [Appendix A](#).

---





**FIX OUTPUT/CANCEL FIX OUTPUT**

The fix output function allows the output to be held at a specific (fix) percentage value of output. This can be used for diagnostic purposes. The output of the field device does not change until cancel fix output is performed. The following procedure steps through the fix and cancel fix output procedure.

Key	Display	Comments
	<div style="border: 1px solid black; padding: 5px;">                     → FIX OUTPUT                      CANCEL FIX OUT                      LCD SETUP                      STANDARD CONFIG                      RST CFG CHANGED FLG                 </div>	Select <i>FIX OUTPUT</i> . If <i>CANCEL FIX OUTPUT</i> is selected, press <b>ENTER</b> and the <i>READY</i> screen appears.
	<div style="border: 1px solid black; padding: 5px;">                     FIX OUTPUT TO:                      nnn.nn%                 </div>	Use the number key pad to input the desired fix output value.
	<div style="border: 1px solid black; padding: 5px;">                     ID TAGNAME                      READY                 </div>	The output remains at a fixed value until <i>CANCEL FIX OUT</i> is selected.

**LCD SETUP**









This function allows the device output to be displayed in secondary units, primary units, or percentage of output on the local display of the device. In addition, transducer or junction temperature values and ID tag name may be available. Check appropriate Appendix for parameters available.

Key	Display	Comments
  	<div data-bbox="597 525 932 674" style="border: 1px solid black; padding: 5px;">                     FIX OUTPUT                      CANCEL FIX OUT                      → LCD SETUP                      STANDARD CONFG                      RST CFG CHANGED FLG                 </div>	Use the arrow keys to select <i>LCD SETUP</i> .  <b>NOTE:</b> Menu selections will vary depending on device type.
	<div data-bbox="597 871 932 1008" style="border: 1px solid black; padding: 5px;">                     → SECONDARY E. U.                      PRIMARY E. U.                      % OUTPUT                      CELL TEMP.                 </div> <div data-bbox="597 1115 932 1251" style="border: 1px solid black; padding: 5px;">                     ID TAGNAME                      READY                 </div>	Specify the LCD display variable. The selected parameters will be displayed locally on the device LCD.  <b>NOTE:</b> An additional selection for LCD setup can exist called <i>ID TAG</i> . This option allows non-HART devices to display the ID tag name locally on the device LCD.

## OPERATING PROCEDURES

### STANDARD CONFIGURATION

This function allows the device to be configured using the original factory configuration.

Key	Display	Comments
   	<div style="border: 1px solid black; padding: 5px;">           FIX OUTPUT            CANCEL FIX OUT            LCD SETUP            → STANDARD CONFG            RST CFG CHANGED FLG         </div>	Use the arrow keys to select <i>STANDARD CONFG</i> .
	<div style="border: 1px solid black; padding: 5px;">           RESET TO STD.            CONFIGURATION?            [                    ]            PRESS ENTER         </div>	Press <b>ENTER</b> to reset the transmitter name in brackets back to the standard configuration, or press <b>CLEAR</b> to abort the reset function.
 	<div style="border: 1px solid black; padding: 5px;">           OUTPUT WILL BE            AFFECTED! PROCEED?            NO            → YES         </div>	Select <i>YES</i> .
	<div style="border: 1px solid black; padding: 5px;">           SENDING            STANDARD CONFIG         </div>	
	<div style="border: 1px solid black; padding: 5px;">           CHOOSE A TAG            READY         </div>	Use <b>SELECT DEVICE</b> to select a tag as the working configuration.

**RESET CONFIGURATION CHANGE FLAG**

This function resets the configuration change flag on HART devices. When a device configuration parameter changes on a PTH or EBTH, a change flag is set. When a change flag is set and a device status is retrieved, the message: *CONFIG CHANGED* appears. When reset, the status of the device is *OK*.

Key	Display	Comments
<div data-bbox="435 535 521 619" style="border: 1px solid black; padding: 2px; text-align: center;">SPECIAL FEATURE</div> <div data-bbox="435 632 521 716" style="border: 1px solid black; padding: 2px; text-align: center;">↓</div> <div data-bbox="435 730 521 814" style="border: 1px solid black; padding: 2px; text-align: center;">↓</div> <div data-bbox="435 829 521 913" style="border: 1px solid black; padding: 2px; text-align: center;">↓</div> <div data-bbox="435 928 521 1012" style="border: 1px solid black; padding: 2px; text-align: center;">↓</div>	<div data-bbox="597 525 932 667" style="border: 1px solid black; padding: 5px;">           FIX OUTPUT            CANCEL FIX OUT            LCD SETUP            STANDARD CONFG            → RST CFG CHANGED FLG         </div>	<p>Use the arrow keys to select <i>RST CFG CHANGED FLG</i>. Clears the configuration changed flag of the HART device.</p>
<div data-bbox="435 1094 521 1178" style="border: 1px solid black; padding: 2px; text-align: center;">ENTER</div>	<div data-bbox="597 1081 932 1220" style="border: 1px solid black; padding: 5px;">           CHOOSE A TAG            READY         </div>	

## Monitor Key Functions

The monitor key functions slightly vary, based on the device. An example of the PTS transmitter is explained in this section.

Use the monitor function key to monitor:

- Primary output.
- Primary input.
- Secondary engineering units.
- Temperature of cell.



### NOTES:

1. For details about monitor key functions, refer to **Monitor Key Functions** in Appendix A.
2. A device must be connected to the terminal in order to use the monitor key functions.

---





## MONITOR PRIMARY OUTPUT

This function allows output monitoring of the field device. The output is displayed in percentage of the calibrated range.

Key	Display	Comments
	<pre>→ PRIMARY OUTPUT PRIMARY INPUT SECONDARY UNITS TEMPERATURE</pre>	Select <i>PRIMARY OUTPUT</i> .
	<pre>ID TAGNAME PRIMARY OUTPUT:   nnn.nn% GOOD STATUS</pre>	The output is displayed in percentage of the calibrated range. The display is updated every second. Press <b>CLEAR</b> to exit the monitor input function.
	<pre>ID TAGNAME   READY</pre>	

**MONITOR PRIMARY INPUT**





This function allows input monitoring of the field device. The input is displayed in engineering units.

Key	Display	Comments
 	<div data-bbox="597 428 932 567" style="border: 1px solid black; padding: 5px;">                     PRIMARY OUTPUT                      → PRIMARY INPUT                      SECONDARY UNITS                      TEMPERATURE                 </div>	Select <i>PRIMARY INPUT</i> using the down arrow key.
	<div data-bbox="597 722 932 861" style="border: 1px solid black; padding: 5px;">                     ID TAGNAME                      PRIMARY INPUT:                      nnn.nn UNITS                      GOOD STATUS                 </div>	The input is displayed in primary engineering units. The display is updated every second. To exit the monitor input function, press <b>CLEAR</b> .
	<div data-bbox="597 932 932 1071" style="border: 1px solid black; padding: 5px;">                     ID TAGNAME                      READY                 </div>	

## OPERATING PROCEDURES





### MONITOR SECONDARY UNITS OUTPUT



This function allows the output to be viewed in secondary units.

Key	Display	Comments
  	<pre>PRIMARY OUTPUT PRIMARY INPUT → SECONDARY UNITS TEMPERATURE</pre>	Select <i>SECONDARY UNITS</i> using the down arrow key.
	<pre>ID TAGNAME SECONDARY UNITS   nnn.nn UNITS GOOD STATUS</pre>	The output is displayed in secondary units.
	<pre>ID TAGNAME  READY</pre>	

### TEMPERATURE FUNCTION

Displays the temperature of the transducer or reference temperature in degrees Celsius.

Key	Display	Comments
   	<pre>PRIMARY OUTPUT PRIMARY INPUT SECONDARY UNITS → TEMPERATURE</pre>	Select <i>TEMPERATURE</i> using the down arrow key.

Key	Display	Comments
	<div style="border: 1px solid black; padding: 5px; width: fit-content;">                     ID TAGNAME                      TEMPERATURE:                      nnn.nn°C                      GOOD STATUS                 </div>	The temperature of the transducer or reference temperature is displayed.
	<div style="border: 1px solid black; padding: 5px; width: fit-content;">                     ID TAGNAME                      READY                 </div>	

**Status Check**

The following is a procedure for checking the status of a device based on the results of the continual self diagnostics. The diagnostics include monitoring the transducer, transducer temperature, transmitter ambient temperature, input circuits, processor EEPROM, nonvolatile memory, and reference voltages.

**NOTE:** When status key is pressed, the problem holding the highest priority (based on an internal priority structure) is displayed for ABB digital FSK devices. Any other problem that may exist cannot be viewed until the problem with the highest priority is corrected. HART devices show the top eight (priority) messages in a single scrollable screen. If an error message is displayed, refer to [Section 5](#) for troubleshooting information.

Key	Display	Comments
	<div style="border: 1px solid black; padding: 5px; width: fit-content;">                     FIELD DEVICE                      O.K.                 </div>	Test results were successful, no problems to report. If the field device has diagnosed a problem in any of the areas mentioned above, refer to <a href="#">Section 5</a> of this product instruction.

**Rerange Key Function**







Use the rerange key to change the:

- Upper and lower range values of the field device.
- Upper and lower temperature alarm values of the field device (where available).
- Upper and lower secondary units.
- Damping time.

**NOTE:** Field device output is based on the values entered in this procedure. The terminal will not reject invalid ranges; therefore, it is imperative that the range limits specified for the device are known. Refer to the applicable product instruction for range limits.



## OPERATING PROCEDURES

Key	Display	Comments
 	<p>OUTPUT WILL BE AFFECTED! PROCEED? NO → YES</p>	<p>This operation will cause a change in output not corresponding to the input. Be sure the control loop is in manual.  Use the down arrow key to select YES.</p>
	<p>LOWER RANGE VAL _nn.nn iH20 UPPER RANGE VAL nn.nn iH20</p>	<p>Engineering units displayed are those selected during configuration or calibration. The positioner sends the ranges to the positioner after specifying the upper and lower range values.</p>
	<p>SECONDARY L. R. _nn.nn UNITS SECONDARY U. R. nn.nn UNITS</p>	<p>Input the desired value using the numeric keypad. Press <b>ENTER</b>. Repeat for upper range value.</p>
	<p>LOWER TEMP ALARM -50.00°C UPPER TEMP ALARM 120.00°C</p>	<p>Lower and upper temperature alarms apply only when reranging PTS, PTH, EQS or EBTH transmitter.  -50.00° and 120.00°C are the default values. Enter different values or accept the default values by pressing <b>ENTER</b>.</p>
	<p>DAMPING (0-32 SEC) nn.nn SEC</p>	<p>Input the desired value using the numeric keypad. Press <b>ENTER</b>.</p>
	<p>SENDING RANGES</p>	
	<p>ID TAGNAME READY</p>	<p>The rerange key will update the field device configuration, not the STT04 terminal internal configuration. To update the internal STT04 terminal configuration, use the get configuration key to view and save the configuration to the STT04 terminal.</p>



**Options Key Functions**

Use the options function key to:

- Set the language of the display screens.
- Change communications format.
- Check the battery charge.
- View the STT04 name.
- View STT04 firmware and boot code revision numbers.

**LANGUAGE**

Use this function to select the language of the STT04 display screens.





Key	Display	Comments
	<div style="border: 1px solid black; padding: 5px;">                     STT04 OPTIONS:                      → LANGUAGE                      COMMUN. FORMAT                      BATTERY                 </div>	Select <i>LANGUAGE</i> .
	<div style="border: 1px solid black; padding: 5px;">                     → ENGLISH                      FRANCAIS                      DEUTSCH                      ESPANOL                 </div>	Select the language using the up and down arrow keys. The last language selection made is maintained for the next power up.
	<div style="border: 1px solid black; padding: 5px;">                     ID TAGNAME                      READY                 </div>	The STT04 terminal will display screens in the selected language.

## OPERATING PROCEDURES

---

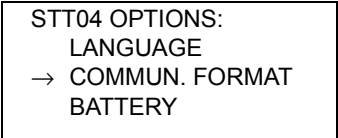

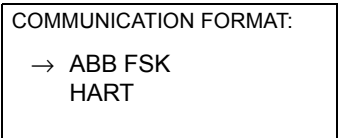
### COMMUNICATION FORMAT

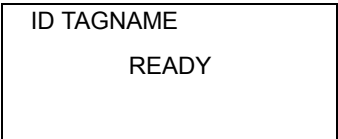
Use this function to change the communications format of the STT04 terminal.

Key	Display	Comments
		Select <i>COMMUN. FORMAT</i> .
		
		Select the desired communication format using the up and down arrow keys. After selecting communications, the terminal scans for devices of the selected format. Select the correct communication format.
		

### BATTERY

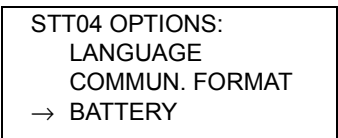
Use this function to see the approximate amount of charge left in the batteries.

Key	Display	Comments
		Select <i>BATTERY</i> .
		
		

Key	Display	Comments
ENTER	AVAILABLE BATTERY CHARGE: nn %	Shows an approximation of the remaining charge on the batteries as a percentage. Recharge the battery when the available charge is below 25 percent.
ENTER	ID TAGNAME READY	

**STT04 NAME**

Use this function to view the name of the STT04 terminal as specified in the DownLink software program.







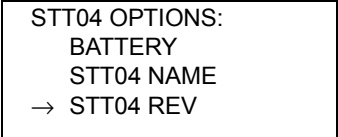

Key	Display	Comments
OPTIONS	STT04 OPTIONS: COMMUN. FORMAT BATTERY → STT04 NAME	Select <i>STT04 NAME</i> .
↓		
↓		
↓		
↓		
ENTER	STT04 NAME ABB STT04	Shows the name of the STT04 terminal as specified in the DownLink software application.
ENTER	ID TAGNAME READY	

## OPERATING PROCEDURES

---

### STT04 REVISION

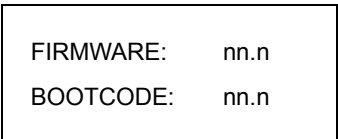
Use this function to view the firmware and boot code revisions of the STT04 terminal.

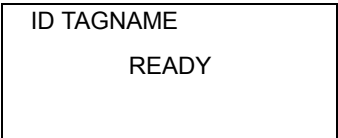
Key	Display	Comments
		Select <i>STT04 REV.</i>
		
		
		
		
		
		Shows the firmware and boot code revisions of the STT04 terminal.
		

**UPLOADING AND DOWNLOADING CONFIGURATIONS**

STT04 terminal provides configuration storage flexibility. Configurations can be created and stored on the STT04 terminal or stored remotely on a personal computer. To remotely store configurations, the DownLink software is required. DownLink software is shipped with the STT04 (A1.1 or greater) terminal.

**NOTE:** If you do not have the DownLink software application, contact the nearest ABB sales office for availability.

Use the following procedure to upload or download configurations:

1. Connect the female end of the RS-232-C (customer supplied) cable to a vacant RS-232-C port (serial port) on the personal computer.
2. Connect the male end of the RS-232-C cable to the STT04 terminal.
3. If the personal computer is not on, turn it on and allow it to boot.
4. Turn off the STT04 terminal.
5. Put the STT04 terminal into the remote mode by pressing one of the following key sequences based on the language of the STT04 terminal (Table 4-2).

*Table 4-2. Languages*

Language	STT04 Key Sequence
English	Hold down <b>1</b> and <b>↑</b> and press <b>On</b> .
French	Hold down <b>2</b> and <b>↑</b> and press <b>On</b> .
Spanish	Hold down <b>3</b> and <b>↑</b> and press <b>On</b> .
German	Hold down <b>4</b> and <b>↑</b> and press <b>On</b> .

The STT04 terminal screen displays the following:

ABB STT04  
IN  
REMOTE MODE

**NOTE:** The first line that reads *ABB STT04* is the default STT04 name. A unique STT04 name should be specified using the DownLink software application. In which case, the specified name would appear in place of *ABB STT04*.

6. Click *Start* on the personal computer and open the *ABB-STT04* program group.

## OPERATING PROCEDURES

---

7. Double click the *STT04 DownLink Software* icon.

### Upload form STT04 to PC

- a. Click *Transfer Configuration* and select *Upload from STT04*.
- b. Select a configuration and click *Ok*.

### Download to STT04 from PC

- a. Click *Transfer Configuration* and select *Download to STT04*.
- b. Select a configuration and click *Ok*.

8. When the download process is complete, turn off the STT04 terminal and disconnect the RS-232-C cable from the STT04 and PC.

---

## SECTION 5 - TROUBLESHOOTING

---

### INTRODUCTION

This section contains all of the possible error messages that can display on the STT04 terminal.

The troubleshooting tables have four columns:

- The **Message** column lists the errors (alphabetically) exactly as they appear on the terminal.
- The **Affected Device** column lists the device type the error can affect. Some probable cause and corrective action may vary depending on the affected device.
- The **Probable Cause** column provides a brief explanation of the cause of the error.
- The **Corrective Action** column lists corrective actions to take for each error.

---

### ERROR MESSAGES

When the Status key is pressed, if a problem exists an error message is displayed. The errors are based on an internal priority structure where the most critical error takes priority over less critical errors. ABB digital FSK devices only show one error message at a time. If more than one error message is present, the one holding the highest priority must be corrected before other lower priority messages can be viewed. HART device error messages only occupy one line on the LCD, therefore more than one error message can be viewed at one time. Table 5-1 lists the HART error messages in alphabetical order. Table 5-2 lists ABB FSK device specific and common STT error messages in alphabetical order.

**NOTE:** The most common cause of field problems occur due to wiring errors or DCS system configuration errors. Check these areas first before proceeding.



Table 5-1. STT04 Error Messages for HART Devices

Message	Affected Device	Probable Cause	Corrective Action
A/D HIGH REF FAIL	PTH EBTH	Reference problem on circuit board.	Replace amplifier assembly. If problem still exists, replace cell and characterization board. Refer to the repair/replacement section of the appropriate instruction.
A/D LOW REF FAIL	PTH EBTH	Reference problem on circuit board.	Replace amplifier assembly. If problem still exists, replace cell and characterization board. Refer to the repair/replacement section of the appropriate instruction.
AMBIENT TEMP HIGH	EBTH	Temperature inside the electronics housing exceeds 85°C (185°F)	Remove the source of temperature extreme.
AMBIENT TEMP LOW	EBTH	Temperature inside the electronics housing is less than -50°C (-58°F)	
AO SATURATED	All HART	Process variable is greater than +103.13% or less than -1.25% of its range and the analog output cannot show changes in its process.	Check for proper sensor connection to the transmitter.
			Check that the transmitter range is appropriate for the application.
			Perform a D/A adjustment.
CAL OFFSET WARNING	TB82	Large positive sensor offset (>180 mV) or large negative sensor offset (<-180 mV)	Clean sensor and perform buffer and process calibration.
			Inspect sensor and calibrating for shorts. Remove all potential shorts to ground, conduit or metals.
CAL OFFSET WARNING (continued)	TB82	Large positive sensor offset (>180 mV) or large negative sensor offset (<-180 mV)	If sensor is functioning properly, order spare sensor to replace existing sensor with spare when transmitter does not accept calibration values.
CALIBRATION FAILED HIGH/LOW	EBTH	The applied calibration signal is higher/lower than allowable factory limits.	Calibrate the transmitter and verify the supplied signals are within transmitter limits.
CALIBRATION REQUIRED	PTH EBTH	Field device needs to be calibrated.	Calibrate the field device. Refer to the calibration section of the appropriate product instruction.
CELL EEPROM FAILURE	PTH	Memory problem.	Remove power from the field device and reapply. If problem persists replace the amplifier assembly. Refer to repair/replacement section of the field device product instruction.
CELL TEMP OVR/ UNDR ALARM	PTH	Cell temperature over/ under user alarm limit.	Correct temperature problem.
			Change alarm value. Refer to configuration procedures for <b>PTH PRESSURE TRANSMITTER</b> in Appendix D.

Table 5-1. STT04 Error Messages for HART Devices (continued)

Message	Affected Device	Probable Cause	Corrective Action
CELL TEMP OVR/ UNDR LMT	PTH	Cell temperature input is over/under factory specified limits.	Remove the source of temperature extreme.
COLD START	All	Reset or self-test of the field device occurred or power was removed and reapplied to the device.	No corrective action required. Notification only.
CONFIG CHANGED	All HART	Parameters of configuration changed	Perform RESET CONFIG.
DYNMC TEMP MST FAIL	PTH	Dynamic temperature input exceeded limits set at factory.  <b>NOTE:</b> The temperature of the high side of the cell with respect to the low side of a PTH.	Output may no longer be accurate. Remove source of temperature shift.
ELEC TEMP OVR/ UNDR RANG	PTH	Electronics temperature is outside the factory specified limit.	Remove the source of the temperature extreme.
ELECT TEMP MST FAIL	PTH	Hardware failure of on-board temperature sensor.	Replace amplifier assembly. Refer to repair/replacement section of the appropriate product instruction.
FIELD DEVICE IN MULTIDROP MODE	All HART	Device is in digital mode.	Command cannot be performed. Configure device for analog mode (point-to-point).
FIXED OUTPUT MODE	All HART	STT terminal turned off while the 4 to 20 mA output was being calibrated.	Power down the transmitter and power up the transmitter.
		Transmitter cannot execute command because of fix output.	Take transmitter out of fix output. Refer to <b>FIX OUTPUT/CANCEL FIX OUTPUT</b> in Section 4.
INPUT OVER RANGE	PTH EBTH	Input out of range.	Reduce process input, or configure proper limits. To verify proper limits use <b>GET CONFIG</b> to view the limits.
		Input greater than cell specification.	Reduce input pressure.
INPUT UNDER RANGE	PTH EBTH	Input exceeds the cell specification.	Increase input pressure.
		Input value too low.	Increase process input, or configure proper limits. To verify proper limits use <b>GET CONFIG</b> to view the limits.
MAIN EEPROM FAILURE	PTH EBTH	Memory problem.	Remove power from the field device and reapply. If problem persists replace the amplifier assembly. Refer to repair/replacement section of the appropriate product instruction.

## TROUBLESHOOTING

Table 5-1. STT04 Error Messages for HART Devices (continued)

Message	Affected Device	Probable Cause	Corrective Action
MORE STATUS AVAIL.	All HART	HART device has more status available, but is not understood by the STT because the device is not supported by the STT.	Contact ABB technical support.
NON-PV OUT OF LIMIT	All HART	Process applied to the nonprimary variable is outside the operating limits of the field device.	Correct process input.
OPEN SENSOR	EBTH	Field device temperature transducer failure.	Replace the temperature transducer. (i.e., thermocouple, RTD).
		Field device temperature transducer not connected.	Connect the proper transducer (i.e., thermocouple, RTD).
PV OUT OF LIMITS	All HART	Process applied to the transmitter is outside the transmitter limits.	Correct the process input.
RAM FAILURE	PTH EBTH	Internal RAM failure.	Replace electronics. Refer to the repair/replacement section of the appropriate product instruction.
REF JUNCTION FAILURE	EBTH	Reference junction (CJC) failed.	Replace the amplifier assembly.
SHORTED SENSOR	EBTH	Temperature transducer failure.	Replace temperature transducer.
		Field wiring shorted	Find and correct the wiring problem.
SPAN ZERO KEY ERROR	PTH	Misoperation of EZ CAL option.	Try again.
		Damaged EZ CAL option.	Replace EZ CAL option. Refer to the repair/replacement of the appropriate PTS product instruction.
		Damaged amplifier assembly.	Replace amplifier assembly. Refer to the repair/replacement section of the appropriate PTS product instruction.
TEMP OFFSET WARNING	TB82	High or low temperature offset	Verify sensor wiring connections and inspect cable for shorts. Remove all potential shorts to ground, conduit or metals.
			Verify that sensor had 10 to 15 min. to acclimate to temperature environment to which it was calibrated.
			Disconnect temperature compensator leads from transmitter and measure resistance.
			Replace sensor with spare when transmitter does not accept calibration values.

*Table 5-1. STT04 Error Messages for HART Devices (continued)*

<b>Message</b>	<b>Affected Device</b>	<b>Probable Cause</b>	<b>Corrective Action</b>
TEMP SLOPE WARNING	TB82	High or low temperature slope	Verify sensor wiring connections and inspect cable for shorts. Remove all potential shorts to ground, conduit or metals.
			Verify that sensor had 10 to 15 min. to acclimate to temperature environment to which it was calibrated.
			Disconnect temperature compensator leads from transmitter and measure resistance.
			Replace sensor with spare when transmitter does not accept calibration values.
USER TEMP HI/LO ALARM	EBTH	Cell temperature over/under user alarm limit.	Correct temperature problem.
			Change alarm value. Refer to configuration procedures for <b>EBTH TEMPERATURE TRANSMITTER</b> in Appendix B.

*Table 5-2. STT04 Error Messages for ABB FSK Devices*

<b>Message</b>	<b>Affected Device</b>	<b>Probable Cause</b>	<b>Corrective Action</b>
CALIBRATION REQUIRED	PTS	Cell has not been calibrated with present amplifier assembly.	Calibrate the field device. Refer to the calibration section of the appropriate PTS pressure transmitter instruction.
	EQS	Field device needs to be calibrated.	Calibrate the field device. Refer to the calibration section of the appropriate EQS temperature transmitter instruction.
CANNOT SAVE, CONFIGURATION TOO LARGE	STT	Transmitter type not supported by STT terminal revision level.	Consult ABB to obtain latest STT terminal revision.
CELL CHARACTERIZATION BOARD EEPROM FAILURE	PTS	Damage to cell characterization board.	Turn the STT terminal off and then on. If error still exists, replace cell (refer to repair/ replacement section of the appropriate product instruction for procedure).
CELL TEMPERATURE OVER USER ALARM	PTS EQS	Cell temperature over/under user alarm limit.	Correct temperature problem.
CELL TEMPERATURE UNDER USER ALARM			Change alarm value. Refer to configuration procedures for <b>EQS TEMPERATURE TRANSMITTER</b> in Appendix C or <b>PTS PRESSURE TRANSMITTER</b> in Appendix E.
CELL TEMPERATURE OVER LIMIT	PTS	Cell temperature input is over/under factory specified limits.	Remove the source of temperature extreme.
CELL TEMPERATURE UNDER LIMIT			
COMMAND ABORTED	STT	Cancel key pressed before function was completed.	Try function again.
COMMUNICATION ERROR	STT	Noisy signal.	Check terminal wiring and eliminate source of noise.

## TROUBLESHOOTING

Table 5-2. STT04 Error Messages for ABB FSK Devices (continued)

Message	Affected Device	Probable Cause	Corrective Action
CONFIG TAGNAME ALREADY EXISTS	All FSK	Attempted to copy a configuration to a cartridge or field device where it already exists.	Erase old configuration before copying new one. Refer to <b>OPERATING PROCEDURES</b> in Section 4.
DAMAGED CELL OR CHARACTERIZATION BOARD	PTS	Characterization board or cell is damaged.	Replace amplifier assembly. Refer to repair/replacement section of the appropriate product instruction.
			Replace cell/characterization board. Refer to repair/replacement section of the appropriate product instruction.
DEVIATION ALARM	AVS	Deviation has been greater than the alarm setting for two minutes.	Check valve.
			Check PID tuning.
DEVICE IN WRITE PROTECT MODE	STT	Device is write protected.	Change mode of device before trying to configure or calibrate.
DYNAMIC TEMPERATURE MEASUREMENT FAILURE	PTS	Dynamic temperature input exceeded limits set at factory.  <b>NOTE:</b> The temperature of the high side of the cell with respect to the low side of a PTS.	Output may no longer be accurate. Remove source of temperature shift.
ELECTRONICS TEMPERATURE MEASUREMENT FAILURE	EQS PTS	Hardware failure of on-board temperature sensor.	Replace amplifier assembly. Refer to repair/replacement section of the appropriate product instruction.
ELECTRONIC TEMPERATURE OUT OF RANGE	PTS	Electronics temperature is outside the factory specified limit.	Remove the source of the temperature extreme.
EMPTY PIPE	XM/SM/ XE	The flowmeter is empty.	Allow process to fill flow tube.
ERROR! ATTEMPT TO CONFIGURE DUPLICATE ADDRESS	All FSK	Attempt was made to assign an analog mode transmitter an address on FBS module.	Be sure transmitter is in the correct mode (analog or digital). Use <b>VIEW</b> to verify mode. Refer to <b>OPERATING PROCEDURES</b> in Section 4 for details.
		Attempt was made to assign a digital mode transmitter to an occupied FBS address.	Assign transmitter to an unoccupied address or channel number of FBS module.
ERROR! DEVICE TYPE AND CONFIGURATION NOT COMPATIBLE	All FSK	The configuration type (i.e., PTS) does not match the device type (i.e., BCN).	Select a device that is compatible with the configuration.
FIELD DEVICE CAN'T EXECUTE COMMAND: COMMAND CONFLICT	BCN EQN TBN	Commands were sent by STT terminal in the wrong order. Verify IMFBS01 is off-line if STT terminal is in use.	Try command again.

Table 5-2. STT04 Error Messages for ABB FSK Devices (continued)

Message	Affected Device	Probable Cause	Corrective Action
FIELD DEVICE CAN'T EXECUTE COMMAND: FBS ON-LINE	All FSK	STT terminal cannot change any transmitter parameters while the field bus is active.	Transmitter must be brought off-line. This can be done from the MFC/MFP by tuning the function code.  <b>NOTE:</b> To bring transmitter off-line, the retainer can be unplugged from the rack. Be aware that by doing this, communication is lost for all other transmitters on the bus. When the retainer is unplugged, there is a 2-minute time out period until the STT terminal will be allowed to change parameters. After the 2-minute period, the transmitter allows the STT terminal access.
FIELD DEVICE CAN'T EXECUTE COMMAND: HARDWARE PROBLEM	BCN EQN TBN	Detected error in hardware.	Press <b>STATUS</b> to determine error and use this table for appropriate corrective action. If status is not more explicit, check electronics assembly of field device.
	AVS	Unspecified hardware failure	Service unit.
FIELD DEVICE CAN'T EXECUTE COMMAND: INVALID COMMAND	All FSK	Incorrect syntax.	Wrong device type selected in the configuration. Refer to the appropriate device configuration appendix for details about device type.
		Excessive line noise.	Check line noise. Use an oscilloscope to determine if line noise is excessive.
		STT terminal failure.	Verify STT terminal is operational by using another STT terminal that is known to be operational.
FIELD DEVICE CAN'T EXECUTE COMMAND: LOCKOUT ENGAGED	All FSK	Unable to configure or calibrate. Hardware lock active.	Refer to the device product instruction for details about the configuration lockout jumper.
FIELD DEVICE CAN'T EXECUTE: DATA OUT OF RANGE	All FSK	Transmitter sent data that is out of acceptable range.	Press <b>VIEW</b> to verify the parameters of the configuration and consult the appropriate device instruction for correct parameters.
FIELD DEVICE CONFIGURATION DOES NOT MATCH STT'S	All FSK	Configuration of the transmitter does not exactly match the corresponding configuration in the STT terminal.	Rerange was executed without updating the STT terminal configuration. Perform <b>GET CONFIG</b> . Refer to <b>GET CONFIGURATION</b> in Section 4.  <b>NOTE:</b> The positioner will change the installed option flags if they are incorrect in the transmitted configuration. This error will appear if the configuration is not reloaded by the STT terminal.
FIELD DEVICE MAIN ELECTRONICS EEPROM FAILURE	BCN EQN TBN	Memory problem.	Reconfigure and recalibrate the transmitter. Refer to the appropriate configuration and calibration sections in this instruction for the transmitter type.
	EQS PTS	Memory problem.	Remove power from the field device and reapply. If problem persists replace the amplifier assembly. Refer to repair/replacement section of the field device product instruction.

## TROUBLESHOOTING

Table 5-2. STT04 Error Messages for ABB FSK Devices (continued)

Message	Affected Device	Probable Cause	Corrective Action
FIELD DEVICE EPROM CHECKSUM ERROR	AVS BCN EQN TBN	Abnormal power up occurred.	Remove power from the field device and reapply.
		Program chip on microcomputer board is bad.	Replace microcomputer board. Refer to repair/replacement section of the appropriate product instruction for procedures.
		Configuration has been lost or corrupted.	Resend the configuration.
FIELD DEVICE INPUT OVER RANGE	AVS BCN EQN EQS	Input out of range.	Reduce process input, or configure proper limits. To verify proper limits use <b>GET CONFIG</b> to view the limits.
	PTS	Input greater than cell specification.	Reduce input pressure.
FIELD DEVICE INPUT UNDER RANGE	PTS	Input less than cell specification.	Increase input pressure.
	AVS EQS	Input value too low.	Increase process input, or configure proper limits. To verify proper limits use <b>GET CONFIG</b> to view the limits.
FIELD DEVICE INTERNAL REFERENCE FAILURE	AVS BCN EQN EQS XM/SM/ XE	Reference problem on circuit board.	Check connections. Replace electronics assembly. Refer to repair/replacement section of the appropriate field device instruction.
	PTS	Reference problem on circuit board.	Replace amplifier assembly. If problem still exists, replace cell and characterization board. Refer to the repair/replacement section of the appropriate PTS instruction.
FIELD DEVICE MAIN INPUT FAILURE	BCN EQN TBN	Sensor failure.	Check input board connections. Refer to repair/replacement section of the appropriate product instruction.
		Input board failure.	Replace input board. Refer to repair/replacement section of the appropriate product instruction.
FIELD DEVICE MICROCOMPUTER HAS BAD EEPROM	BCN EQN TBN	Microcomputer cannot retain configuration and calibration data.	Replace the microcomputer board. Refer to repair/replacement section of the appropriate product instruction.

Table 5-2. STT04 Error Messages for ABB FSK Devices (continued)

Message	Affected Device	Probable Cause	Corrective Action
FIELD DEVICE NOT RESPONDING	All FSK	Noise on field wiring.	Turn off STT terminal. ID tags appear on screen. Select the ID tag of the transmitter or, select the one appearing within brackets if unsure of ID tag. Press <b>ENTER</b> . Press <b>STATUS</b> . If message is still present, continue to the next corrective action.
		STT terminal not connected properly.	Check STT terminal wiring connections. Refer to Figure 2-1 or 2-2 for correct wiring arrangements.
		Short in communication wire.	Perform a continuity check to determine if a short exists.
		Transmitter does not have a minimum amount of voltage across inputs.	Correct power problem. Refer to appropriate product instruction for minimum supply voltage requirements.
		Transmitter or STT terminal is defective.	If available, verify that the STT terminal is functional by interfacing another transmitter. Replace the STT terminal if not functional.
			If STT terminal is functional, replace field device electronics assembly. PTS: Replace amplifier assembly, refer to repair/replacement section of the appropriate product instruction for replacement procedures.
FIELD DEVICE NOT SUPPORTED BY STT	All FSK	Field device type not supported by the release of STT terminal.	Contact an ABB sales office for upgrade information.
FIELD DEVICE OPEN SENSOR	EQS	Field device temperature transducer failure.	Replace the temperature transducer. (i.e., thermocouple, RTD).
		Field device temperature transducer not connected.	Connect the proper transducer (i.e., thermocouple, RTD).
FIELD DEVICE OUTPUT IS FIXED OR IN ADJ. MODE	All FSK	STT terminal turned off while the 4 to 20 mA output was being calibrated.	Power down the transmitter and power up the transmitter.
		Transmitter cannot execute command because of fix output.	Take transmitter out of fix output. Refer to <b>FIX OUTPUT/CANCEL FIX OUTPUT</b> in Section 4.
FIELD DEVICE RAM FAILURE	All FSK	Internal RAM failure.	Replace electronics. Refer to the repair/replacement section of the appropriate product instruction.



## TROUBLESHOOTING

Table 5-2. STT04 Error Messages for ABB FSK Devices (continued)

Message	Affected Device	Probable Cause	Corrective Action
FIELD DEVICE TEMPERATURE ABOVE LIMIT  - or -  FIELD DEVICE TEMPERATURE BELOW LIMIT	BCN EQN EQS TBN XM/SM/ XE	Field device not calibrated properly, or transmitter is at a temperature above the performance specifications. Message will not affect operation but could mean temperature performance is out of range.	Recalibrate the field device. Refer to the appropriate calibration section for the device type.  <b>NOTE:</b> Uncalibrated field devices may have this error until calibrated.
	PTS	Local heat or cold source exceeds electronics specifications.	Eliminate or reduce temperature extreme of the electronics.
FIELD DEVICE TEMPERATURE SENSOR FAILURE	BCN EQN	On-board temperature sensor failure.	Replace input board. Refer to repair/replacement section of the appropriate product instruction.
HIGH PROCESS ALARM	XM/SM/ XE	Process value over/under alarm limit.	Correct process problem.  Change alarm value. Refer to <b>CREATE/MODIFY CONFIGURATION</b> in Appendix I.
INPUT APPLIED INCORRECTLY, CALIBRATION FAILURE	BCN EQN EQS PTS TBN	Input signal not at specified level.	Correct signal and recalibrate. Refer to the appropriate calibration section for details.
LOSS OF COIL EXCITATION	XM/SM/ XE	Coil excitation has stopped.	Check wiring of excitation signal and reference signal. If both are OK, call service.
LOW PROCESS ALARM	XM/SM/ XE	Process value over/under alarm limit.	Correct process problem.  Change alarm value. Refer to <b>CREATE/MODIFY CONFIGURATION</b> in Appendix I.
MAIN POWER WAS LOST	XM/SM/ XE	Power was lost to device.	Check for loose wiring. Restore totalizers to known values if lost.
NO SMART FIELD DEVICE CONFIGURATIONS PRESENT	STT	No configuration exists in the STT terminal memory.	Create configurations. Refer to <b>OPERATING PROCEDURES</b> in Section 4.
NO SMART FIELD DEVICE RESPONDING	STT	STT terminal not connected to a device.	Check STT terminal lead connections. Verify proper field device wiring. Refer to the installation section of the appropriate product instruction.
OPTION NOT INSTALLED	XM/SM/ XE	The current configuration is calling to use the empty pipe detector which requires and optional board.	Add empty pipe detector option, or turn empty pipe detection off in the configuration.
OUTPUT PRESSURE ABOVE LIMIT	AVS	Pressure on output port 01 or 02 is too high.	Check air pressure supply.
POSITION TRANSMITTER	AVS	The position transmitter (transducer) has failed.	Refer to the repair/replacement section of the appropriate positioner product instruction.

Table 5-2. STT04 Error Messages for ABB FSK Devices (continued)

Message	Affected Device	Probable Cause	Corrective Action
SHORTED SENSOR	EBTH	Temperature transducer failure.	Replace temperature transducer.
		Field wiring shorted.	Find and correct the wiring problem.
SOURCE PRESSURE BELOW LIMIT	AVS	Supply pressure is too low.	Check air pressure supply.
SPAN & ZERO KEY MISOPERATION	PTS	Misoperation of EZ CAL option.	Try again.
		Damaged EZ CAL option.	Replace EZ CAL option. Refer to the repair/replacement of the appropriate PTS product instruction.
		Damaged amplifier assembly.	Replace amplifier assembly. Refer to the repair/replacement section of the appropriate PTS product instruction.
STT CONFIG WRITE ERROR	STT	Error saving configuration.	Save configuration again. If problem persists contact ABB technical support.
STT INTERNAL CONFIG STORAGE FULL	STT	STT terminal memory is full.	Erase some configurations. Refer to <b>OPERATING PROCEDURES</b> in Section 4.
STT RECEIVE CHECKSUM ERROR	STT	Checksum from device was corrupted.	Try again or check data. If message persists, verify that electronic noise on line is within specifications using an oscilloscope.
STT RECEIVE FAILURE	STT	Reply from device was possibly corrupted.	Try again or check data. If message persists, verify that electronic noise on line is within specifications using an oscilloscope.
SYSTEM ERROR	STT	Unexpected interrupt request on STT.	Turn STT off and on again. If error persists, upgrade the STT firmware.
TAG ID LENGTH NOT SUPPORTED BY FIELD DEVICE	BCN EQN	Attempting to send an ID tag name that uses too many characters for the particular transmitter.	Change the ID tag name to 12 or less characters.
TEMP ALARM	AVS	The electronics temperature has exceeded the product specification.	Remove the source of the temperature extreme.
TOTALIZER CHECKSUM ERROR	XM/SM/ XE	Error in stored totalizer value.	Reset totalizer or preset totalizer to a known good value.
UNKNOWN ERROR	All FSK	Transmitter reported an error that was not understood by STT terminal.	Contact ABB technical support.
VALUE ENTERED ABOVE LIMIT	STT	Value specified in the configuration is above the limit.	Refer to the appropriate product instruction for the value limits.
VALUE ENTERED BELOW LIMIT	STT	Value specified in the configuration is below the limit.	Refer to the appropriate product instruction for the value limits.

Table 5-2. STT04 Error Messages for ABB FSK Devices (continued)

Message	Affected Device	Probable Cause	Corrective Action
VALUES OUT OF ACCEPTABLE RANGE FOR FIELD DEVICE	All FSK	Value specified in the configuration is below the limit.	Refer to the appropriate product instruction for the value limits.
			Check 4 to 20 mA input.
VALVE STUCK	Positioner	Valve has not moved for over two minutes.	Check valve.
			Check 4 to 20 mA input.
OPTION NOT INSTALLED	XM/SM/XE	The current configuration is calling to use the empty pipe detector which requires an optional board.	Add empty pipe detector option, or turn empty pipe detection off in the configuration.

---

## SECTION 6 - REPAIR/REPLACEMENT AND UPGRADE

---

### *INTRODUCTION*

This section provides special handling procedures for MOS devices, battery pack replacement, upgrade information and a list of recommended spare parts for the STT04 terminal.

---

### *SPECIAL HANDLING GUIDLINES FOR MOS DEVICES*

Metal oxide semiconductor (MOS) devices are subject to damage by static electricity. Observe the following techniques while servicing and troubleshooting.

1. Most assemblies with MOS devices are shipped in a special anti-static bag. Keep the assembly in the bag as much as possible whenever the assembly is not in the system.
2. Remove assemblies containing MOS devices from their antistatic protective container only under the following conditions:
  - a. When at a static-free work station or when the bag is grounded at the field site.
  - b. After neutralizing the conductive area of the container.
  - c. Only after firm contact with an antistatic mat and/or firmly gripped by a grounded individual.
3. Personnel handling assemblies with MOS devices should be neutralized to a static-free work station by a grounding wrist strap that is connected to the station or to a good ground point at the field site.
4. Do not allow clothing to make contact with MOS devices. Most clothing generates static electricity.
5. Avoid touching edge connectors and components.
6. Avoid partial connection of MOS devices. Damage can occur by floating leads, especially the power supply connector. If inserting an assembly into a live system, do so quickly. Do not cut leads or lift circuit paths when troubleshooting.
7. Be sure test equipment is grounded.

8. Avoid static charges during repair. Make sure circuit board is thoroughly clean around its leads but do not rub or clean with an insulating cloth.

**NOTE:** An antistatic kit (field service kit, ABB part number 1948385?1) is available for personnel working on devices containing MOS components. The kit contains a static-dissipative work surface (mat), a ground cord assembly, wrist bands and alligator clip.

---

### REPLACING THE BATTERY PACK

1. Power off the STT04 terminal.
2. Place the STT04 terminal on a table or smooth surface with the keypad facing down.
3. Remove the four screws from the lower case of the terminal.
4. Carefully lift the lower case off the PC board.
5. Grasp the PC board by the edges and turn it over so the components on the board are facing up (Fig. 6-1).
6. Carefully disconnect the keypad connector strip from the PC board. This will allow the PC board to lie flat next to the upper case assembly.

#### WARNING

**To prevent ignition of a hazardous atmosphere, batteries must only be charged or changed in an area known to be nonhazardous.**

7. Locate the battery pack connector on the circuit board (Fig. 6-1).
8. Squeeze the end of the connector tab and pull the connector from the circuit board.
9. Remove the screw securing the battery pack (Fig. 6-1).
10. Place thumbs on the clips that secure the battery pack.
11. Push the clips away from the battery pack while using your fingers to release the battery pack from the clips.
12. Remove the battery pack and dispose properly.
13. Turn the replacement battery pack over (batteries facing down), and insert the bottom tabs under the Stop on the housing (Fig. 6-1).
14. Press down at the top of the battery pack until it snaps securely into place.
15. Replace the screw that secures the battery housing.

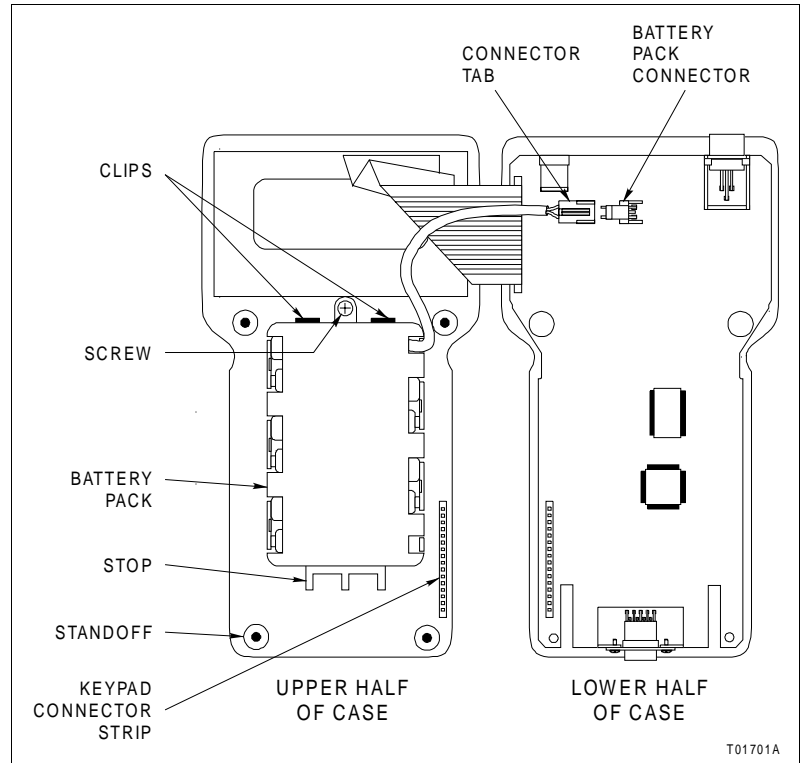

Figure 6-1. Internal Component Locations

16. Reconnect the keypad connector strip.
17. Turn the PC board over, setting and aligning the board with the stand-offs located on the upper case.
18. Place the lower case on the unit, carefully aligning the communication cord receptacle.

**NOTE:** Be sure that wires do not protrude from case assembly.

19. Press the cases together until they properly seat, while maintaining pressure on the cases.
20. Insert the four screws into the back of the lower case and tighten until heads are flush with case.

## UPGRADES

When firmware upgrades are issued for the STT04 terminal, they are obtained via the Internet by connecting to the ABB home page. For information about upgrades, contact your ABB sales representative.

To download firmware upgrades:

1. Connect to the Internet.

## REPAIR/REPLACEMENT AND UPGRADE

Contact your network administrator about connecting to the Internet.

- or -

Use Dial-Up Networking (Accessories program group) to connect via your Internet service provider.

2. Start your Internet browser.
3. Type the following to connect to the ABB home page:

**http://www.abb.com**

4. Type **stt 04** in the Search field on the right side of the screen as shown below (make certain to include a space between the last “t” and the “0” as shown):

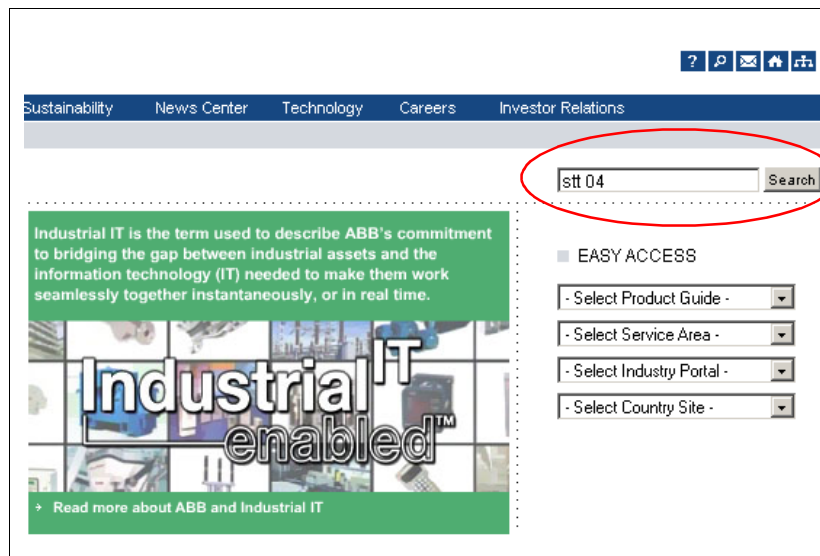

5. The search will yield the following results:

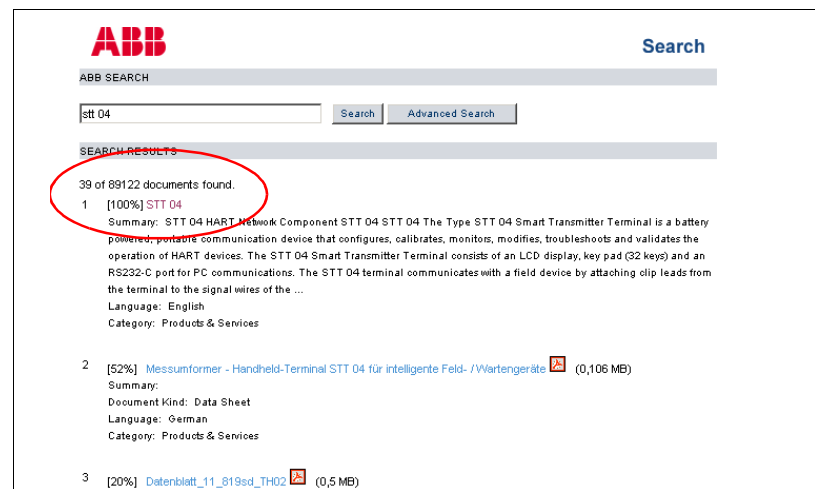

6. Click on the **STT 04** link shown circled above to access the Firmware Upgrade page shown below:

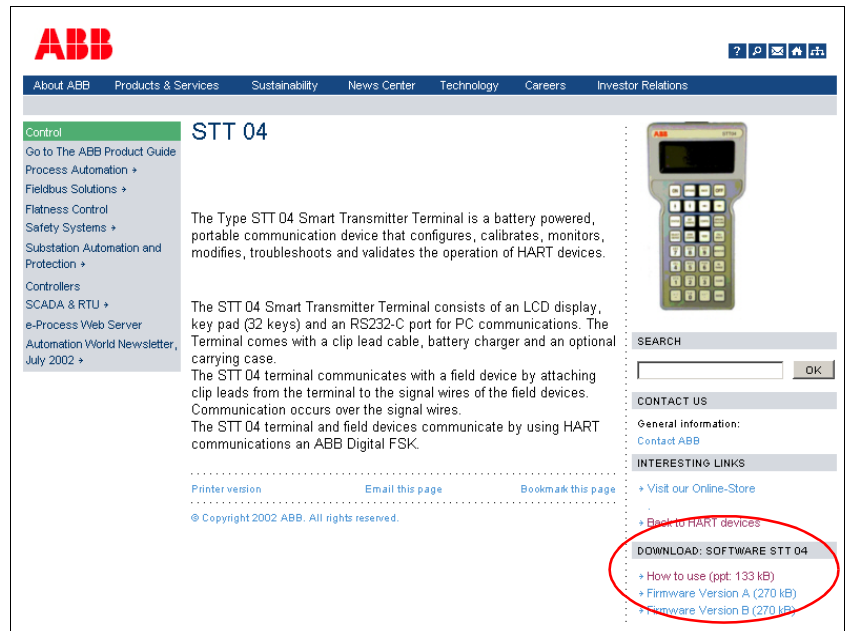

7. The **Download Software** area is located in the lower right corner of the page as shown circled above. Select and download the required STT04 firmware upgrade from this area.

8. To load the firmware upgrade to the STT04 terminal, refer to **DOWNLOADING AN UPGRADE TO THE STT04 TERMINAL** below.

### **DOWNLOADING AN UPGRADE TO THE STT04 TERMINAL**

Use the following steps to download an STT04 firmware upgrade.

1. Check the amount of battery charge left on the STT04 terminal. If it is below 50 percent, charge the STT04 terminal before performing this procedure. To check the charge, see **BATTERY** in Section 4.
2. Connect the female end of the RS-232-C (customer supplied) cable to a vacant RS-232-C port (serial port) on the personal computer.
3. Connect the male end of the RS-232-C cable to the STT04 terminal.
4. If the personal computer is not on, turn it on and allow it to boot.
5. Turn off the STT04 terminal.
6. Put the STT04 terminal into the remote mode by pressing one of the following key sequences based on the language of the upgrade (Table 6-1).



Table 6-1. Upgrade Languages

Language	STT04 Key Sequence
English	Hold down <b>1</b> and <b>↑</b> and press <b>On</b> .
French	Hold down <b>2</b> and <b>↑</b> and press <b>On</b> .
Spanish	Hold down <b>3</b> and <b>↑</b> and press <b>On</b> .
German	Hold down <b>4</b> and <b>↑</b> and press <b>On</b> .

- Click *Start* on the personal computer and open the *ABB-STT04* program group.
- Double click the *STT04 DownLink Software* icon.
- Click *Special Advanced* and select *Upgrade Firmware*. The upgrade process takes several minutes.
- Turn off the STT04 terminal and disconnect the RS-232-C cable from the STT04 terminal and PC.
- Turn the STT04 terminal on. Check the revision number of the start-up screen to verify that the upgrade was successful.

---

### RECOMMENDED SPARE PARTS

Table 6-2 lists the recommended spare parts for the STT04 terminal. Use the kit or part number to order components from your ABB sales representative.

Table 6-2. List of Spare Parts

Part Number	Description
Clip Leads cable Part number 1948517?4	STT04 communication cable.
Battery Pack Part number 1949646?1	Powers the terminal.
Antistatic Part number 1948385?1	Contains static-dissipative work surface and ground cord assembly (wrist bands and alligator clips).
Recharger Part number 1949616?1	Battery charger Input: 110 VAC, 50/60 Hz. Output: 9 VDC, 100 mA.

**NOTE:**

- For non-U.S. standard applications, use a charger that produces 9 VDC, 100 mA, similar to LCR Electronics Inc. part number AD0910B2-PN4 (220).

---

## SECTION 7 - MAINTENANCE

---

### INTRODUCTION

#### WARNING

**System maintenance must be performed only by qualified personnel and only after securing equipment controlled by the circuit. Altering or removing components from an active circuit may upset the process being controlled.**

The STT04 terminal requires limited maintenance when operated under normal conditions. Periodically the battery pack requires charging. Refer to **Charging STT04 Terminal** in Section 3.

If the STT04 terminal is inoperative, or if operation is faulty, refer to the troubleshooting section of this manual.

---

### CLEANING

#### CAUTION

**Do not allow cleaning solution or any other liquid to enter the terminal case as it will damage internal components.**

Before cleaning, turn the terminal off and disconnect it from the communication wires or loop. Make sure the battery charger is also disconnected. Wipe the unit down using a soft cloth dampened with a nonabrasive, mild detergent. Do so as often as the installation environment requires.

---

## SECTION 8 - SUPPORT SERVICES

---

### **INTRODUCTION**

ABB is ready to help in the use, application and repair of its products. Contact your nearest sales office to make requests for sales, applications, installation, repair, overhaul and maintenance contract services.

---

### **REPLACEMENT PARTS**

When making repairs, order replacement parts from an authorized ABB sales representative. Provide the following information:

1. Part description, part number and quantity.
2. Nomenclature and serial numbers (if applicable).
3. ABB instruction manual number, page number and reference figure that identifies the part.

When ordering standard parts from ABB, use the part numbers and descriptions from the spare parts lists. Order parts without commercial descriptions from the nearest ABB sales office.

---

### **SPARE PARTS LISTS**

For available spare parts, refer to **RECOMMENDED SPARE PARTS** in Section 6.

---

### **TRAINING**

ABB has modern training facilities available world wide for training your personnel. On-site training is also available. Contact an ABB sales office for specific information and scheduling.

---

### **TECHNICAL DOCUMENTATION**

Additional copies of this manual are available at the nearest ABB sales office for a reasonable charge.

# APPENDIX A - SMART POSITIONER

## INTRODUCTION

This appendix covers the configuration and calibration functions of the Smart Positioner.

Refer to **OPERATING PROCEDURES** in Section 4 for information on the following functions:

- Send configurations.
- Get configurations.
- View configurations.
- Select configurations.
- Erase configurations.
- Operational functions.

**NOTE:** To change calibration or configuration parameters of a smart field device that is connected to an IMFBS01 module, the device must be taken off-line. This is done at the INFI 90 OPEN console.

## CREATE/MODIFY CONFIGURATION

A configuration can be created off-line, without a connected field device. Figure A-1 provides an overview of the configuration function. The following table details the configuration process.

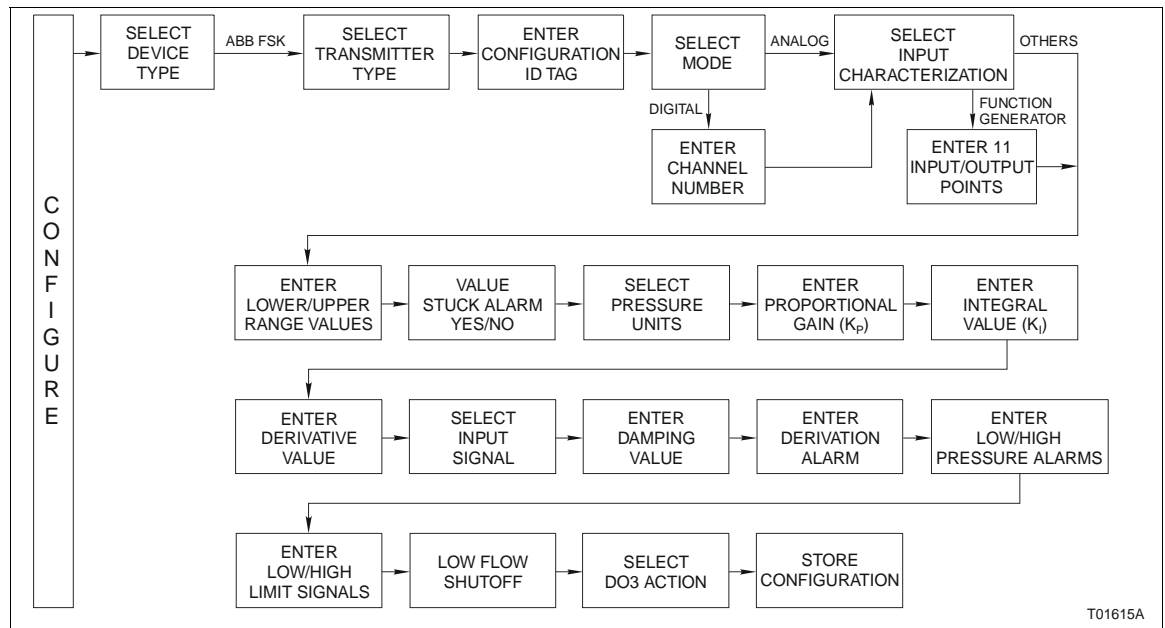



























Figure A-1. Configuration Flowchart (AVS)

# SMART POSITIONER

Key	Display	Comments
	CONFIGURATION → NEW MODIFY ERASE	Select <i>NEW</i> to create a configuration. To modify an existing configuration, select <i>MODIFY</i> . The screen sequence is the same, however, the <i>MODIFY</i> screens will appear with the values and cursor positions as originally configured.
	DEVICE TYPE → ABB FSK HART	Select <i>ABB FSK</i> .
	TRANSMITTER TYPE PTS EQS BCN EQN → AVS TBN480 cond	Use the down arrow key to select <i>Positioner</i> .
		
		
	STT04 CONFIGURATION [                    ] ←PREVIOUS    NEXT→	Enter a name for the configuration ID tag using up to 14 ASCII characters. To select a character, press the key that has the desired character. Continue to press the key until the desired character appears. Use the right arrow key to move to the next character. Use the left arrow key to go back to the previous character.
	SELECT MODE: ANALOG → DIGITAL	Select <i>DIGITAL</i> . Use the up and down arrow keys to select mode.
		<b>NOTE:</b> The <i>DIGITAL</i> selection should only be made when using an IMFBS01 field bus I/O module. Select <i>ANALOG</i> for all other cases.
	ENTER CHANNEL #: nn	This screen only appears in the <i>DIGITAL</i> mode. It is used to assign an address to the positioner for use with the field bus.

Key	Display	Comments
	INPUT CHAR → LINEAR SQUARE ROOT SQUARE	Move the indicator to the choice with the up and down arrow keys. Refer to the appropriate product instruction for input characterization types. For this example <i>LINEAR</i> is the input characterization type.
	LOWER RANGE VAL nn.nn UPPER RANGE VAL nn.nn	Input lower range value using the number keys, then press <b>ENTER</b> . Input the upper range value.
	VALVE STUCK ALARM NO → YES	Set this to <i>YES</i> to be alerted if the actuator has not moved for over two minutes with a change in the input signal.
		<b>NOTE:</b> Review product instruction for details.
	PRESSURE UNIT → PSI BARS	Select <i>PSI</i> units.
	Kp: Prop. Gain nn.nn	Proportional tuning constant. Use numbers between 1 and 0 for small drives and numbers greater than 1 for large drives.
	Ki: Integral nn.nn	Integral tuning constant. This number will usually range from 1 to 40.
	Kd: Derivative nn.nn	Derivative tuning constant. This number will usually range between 2 and 70.

# SMART POSITIONER

Key	Display	Comments
	INPUT SIGNAL: → NORMAL ACT REVERSE ACT	Move the indicator to proper selection. Refer to the Smart Positioner instruction for an explanation of terms.
	DAMPING: (0 - 5 sec) n SECS	The input can be damped with a value of 1 to 5 seconds. A value of 0 will disable this parameter.
	DEVIATION ALARM  n.n%	Set the deviation alarm in % of deviation from the set point.
	LOW PRES ALARM nn.nn UNITS HIGH PRES ALARM nn.nn UNITS	Sets the low pressure alarm for the supply pressure.
	LOW LIMIT SIGNAL nn.nn % HIGH LIMIT SIGNAL nn.nn %	Sets the percent of span that the digital output will be activated.
	LOW FLOW SHUTOFF  n.n %	Sets the minimum input value (in % of span) that the control element will go to 0%.
	DO3 ACTION: → LO PRESS DEVIATION ALARM VALVE STUCK ALARM	Select a DO3 action with the arrow keys. Reference Positioner instruction for details.  <b>NOTE:</b> Scroll with the up and down arrow keys to view other selections.
	STORE THIS CONFIGURATION? NO → YES	Select YES using arrow keys.
		

Key	Display	Comments
	<div style="border: 1px solid black; padding: 5px; width: fit-content; margin: auto;">                     ID TAGNAME                       READY                 </div>	Configuration ID tag name just configured will be in the upper left corner if the configuration is saved. It becomes the working configuration.

**CALIBRATION**

This section details the calibration functions of the STT04 terminal while interfacing an positioner. There are four types of calibration functions:

- Output D-to-A.
- Manual position.
- Input D-to-A.
- Automatic position.

**NOTES:**

1. When calibrating, a field device must be connected to the STT04 terminal.
2. To change calibration or configuration parameters of a field device that is connected to an IMFBS01 module, the transmitter must be taken off-line. This is done at the INFI 90 OPEN console.

After selecting a field device the *READY* screen appears. All calibration functions can be performed on the selected device. Refer to Figure A-2 for an overview of the calibration functions.

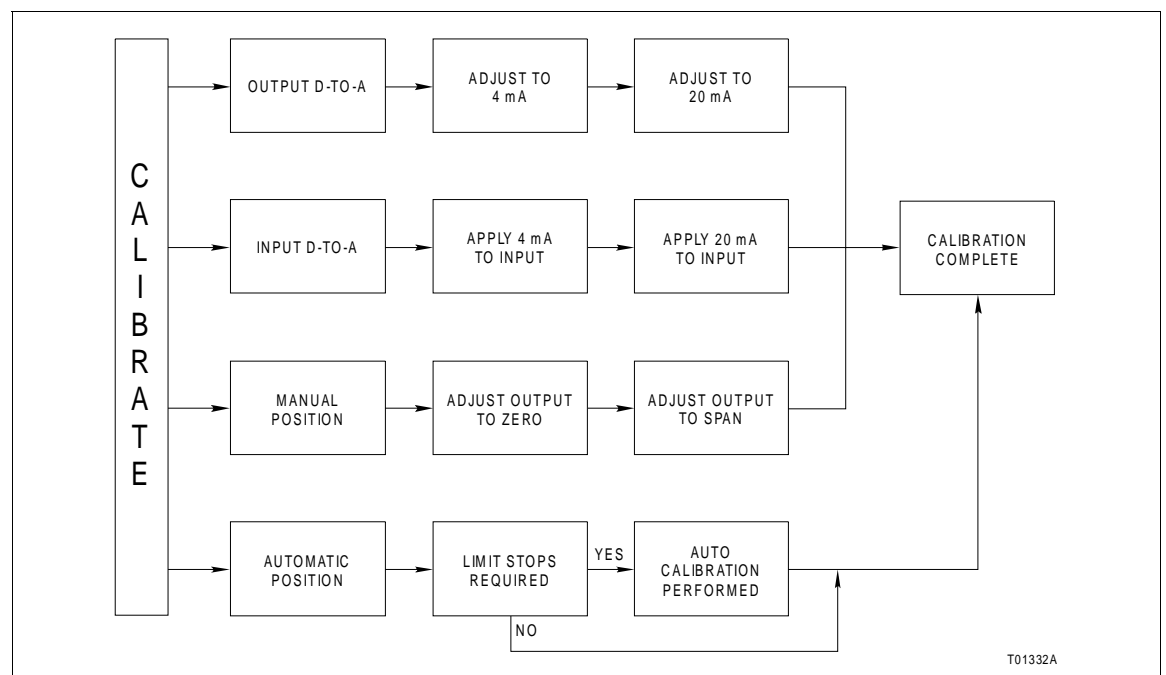







Figure A-2. Calibration Flowchart (AVS)



**Output D-to-A Calibration**







The *D-TO-A ADJUST* selection is only present when you are in the *ANALOG* communication mode, specified in the configuration procedure. This selection allows you to adjust the four to 20 milliampere output of the field device.

**NOTE:** Analog board must be installed for this function.

Key	Display	Comments
	<p>OUTPUT WILL BE AFFECTED! PROCEED? NO → YES</p>	
		
	<p>→ OUTPUT D/A CAL INPUT A/D CAL MAN POSITION CAL AUTO POSITION CAL</p>	<p>Select <i>OUTPUT D/A CAL</i>.</p>
	<p>ADJUST TO 4mA  THEN HIT ENTER</p>	<p>Use the up and down arrow keys to adjust the 4 mA signal.</p>
	<p>ADJUST TO 20 mA  THEN HIT ENTER</p>	<p>Use the up and down arrow keys to adjust the 20 mA signal.</p>
	<p>ID TAGNAME  READY</p>	<p><b>NOTE:</b> Refer to Positioner instruction for details on the calibrations.</p>

**Input A-to-D Calibration**









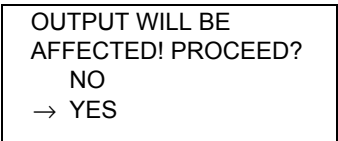

This procedure applies to Positioner configured for either *ANALOG* or *DIGITAL*. Any differences between the two are noted in the **Comments** column.

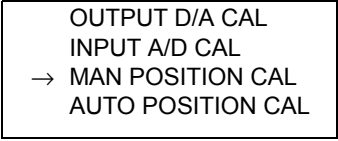
Key	Display	Comments
 	<div data-bbox="597 457 932 596" style="border: 1px solid black; padding: 5px;">                     OUTPUT WILL BE                      AFFECTED! PROCEED?                      NO                      → YES                 </div>	This operation will cause a change in output not corresponding to the input. Be sure the control loop is in manual.  Select <b>YES</b> .
 	<div data-bbox="597 747 932 886" style="border: 1px solid black; padding: 5px;">                     OUTPUT D/A CAL                      → INPUT A/D CAL                      MAN POSITION CAL                      AUTO POSITION CAL                 </div>	Select <i>INPUT A/D CAL</i> .
	<div data-bbox="597 1041 932 1180" style="border: 1px solid black; padding: 5px;">                     APPLY 4 mA                      TO INPUT                      THEN HIT ENTER                 </div>	Make the proper adjustments and press <b>ENTER</b> .  <b>NOTE:</b> Refer to Positioner instruction for details on the calibrations.
	<div data-bbox="597 1241 932 1379" style="border: 1px solid black; padding: 5px;">                     APPLY 20 mA                      TO INPUT                      THEN HIT ENTER                 </div>	Make the proper adjustments and press <b>ENTER</b> .  <b>NOTE:</b> Refer to Positioner instruction for details on the calibrations.
	<div data-bbox="597 1440 932 1579" style="border: 1px solid black; padding: 5px;">                     ID TAGNAME                       READY                 </div>	

# SMART POSITIONER

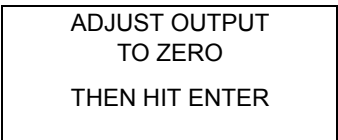

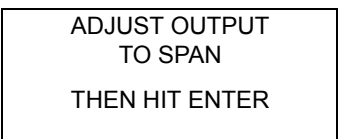

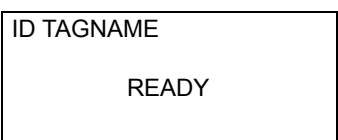



## Manual Position Calibration

This procedure applies to Positioner configured for either *ANALOG* or *DIGITAL*. Any differences between the two are noted in the **Comments** column.

Key	Display	Comments
		<p>This operation will cause a change in output not corresponding to the input. Be sure the control loop is in manual.</p> <p>Select <b>YES</b>.</p>
		
		<p>Select <i>MAN POSITION CAL</i>.</p>
		
		
		<p>Make the proper adjustments and press <b>ENTER</b>.</p> <p><b>NOTE:</b> Refer to Positioner instruction for details on the calibrations.</p>
		<p>Make the proper adjustments and press <b>ENTER</b>.</p> <p><b>NOTE:</b> Refer to Positioner instruction for details on the calibrations.</p>
		

**Automatic Position Calibration**

This procedure applies to Positioner configured for either *ANALOG* or *DIGITAL*. Any differences between the two are noted in the **Comments** column.

Key	Display	Comments
 	<div data-bbox="597 457 930 598" style="border: 1px solid black; padding: 5px;">                     OUTPUT WILL BE AFFECTED! PROCEED?                      NO                      → YES                 </div>	This operation will cause a change in output not corresponding to the input. Be sure the control loop is in manual.  Select <i>YES</i> .
   	<div data-bbox="597 747 930 888" style="border: 1px solid black; padding: 5px;">                     OUTPUT D/A CAL                      INPUT A/D CAL                      MAN POSITION CAL                      → AUTO POSITION CAL                 </div>	Select <i>AUTO POSITION CAL</i> .
	<div data-bbox="597 1266 930 1407" style="border: 1px solid black; padding: 5px;">                     LIMIT STOPS REQUIRED PROCEED?                      NO                      → YES                 </div>	Limit stops are required for the <i>AUTO POS CAL</i> selection.  Select <i>YES</i> .
	<div data-bbox="597 1470 930 1610" style="border: 1px solid black; padding: 5px;">                     AUTO CAL                      STARTED                 </div>	<b>NOTE:</b> Refer to Positioner instruction for details on the calibrations.  The positioner is being automatically calibrated.
	<div data-bbox="597 1665 930 1806" style="border: 1px solid black; padding: 5px;">                     AUTO CAL                      COMPLETE                 </div>	The positioner is calibrated.

## SMART POSITIONER

---

Key	Display	Comments
	<div style="border: 1px solid black; padding: 5px;">           ID TAGNAME             READY         </div>	

---

### SPECIAL FEATURE KEY FUNCTIONS



The special feature key selections available for the positioner vary from the other supported devices. The unique selections pertaining only to the positioner, are as follows:

- Fix set point/cancel fix set point.
- PID parameters.
- Reset Totals.

---

#### **Fix Set Point/Cancel Fix Set Point**







This function locks the position demand set point at a user specified value. This set point value is maintained by the positioner until it is canceled using *CANCEL FIX SET*.

Key	Display	Comments
	<div style="border: 1px solid black; padding: 5px;">           → FIX SET POINT            CANCEL FIX SET            PID PARAMETERS            STANDARD CONFIG         </div>	Select <i>FIX SET POINT</i> . If <i>CANCEL FIX SET</i> is selected, press <b>ENTER</b> and the fix set point is canceled and the <i>READY</i> screen appears.
	<div style="border: 1px solid black; padding: 5px;">           FIX SET POINT TO:            nnn.nn%         </div>	Use the number key pad to input the desired fix set point value.
	<div style="border: 1px solid black; padding: 5px;">           ID TAGNAME             READY         </div>	The set point remains at a fixed value until <i>CANCEL FIX SET</i> is selected.

**PID Parameters**







Use this function to edit the PID parameters of the device. The parameters are as follows:

- Kp** Proportional gain adjustment
- Ki** Integral, the number of resets per minute.
- Kd** Derivative rate action. Positions actuator and help to minimize over-shoot.

Key	Display	Comments
 	<div style="border: 1px solid black; padding: 5px;">                     FIX SET POINT                      CANCEL FIX SET                      → PID PARAMETERS                      STANDARD CONFIG                      RESET TOTALS                 </div>	Select <i>PID PARAMETERS</i> .
	<div style="border: 1px solid black; padding: 5px;">                     Kp:                      PROP. GAIN                      -                 </div>	Use the number key pad to enter the desired gain value. Gain value range: 0.01 to 10
	<div style="border: 1px solid black; padding: 5px;">                     Ki:                      PROP. GAIN                      -                 </div>	Use the number key pad to enter the desired gain value. Gain value range: 1 to 40
	<div style="border: 1px solid black; padding: 5px;">                     Kd:                      PROP. GAIN                      -                 </div>	Use the number key pad to enter the desired gain value. Gain value range: 2 to 70
	<div style="border: 1px solid black; padding: 5px;">                     ID TAGNAME                      READY                 </div>	The PID parameters are sent to the positioner.

**Reset Totals**

The positioner has a travel counter that counts each movement of the positioner. The travel counter increments one for every movement that amounts to five percent of span. The total number of movements is used to help determine when maintenance is performed on final control elements. The reset totals function sets the travel counter to zero.

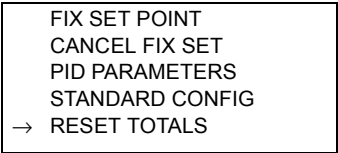
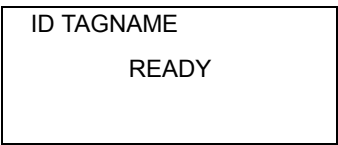





Key	Display	Comments
<p></p> <p></p> <p></p> <p></p> <p></p> <p></p>	<p></p> <p></p>	<p>Select <i>RESET TOTALS</i>.</p> <p>The travel counter is set to zero. To check the travel counter, refer to <i>Status Check</i> in Section 4.</p>

**Monitor Key Functions**

The following functions apply to the positioner.

Use the monitor function key to monitor:

- Position.
- Set point.
- Deviation.
- Temperature.
- Input air supply.
- Output air supply (O1).
- Output air supply (O2).
- Air pressure.
- Travel.
- Reverse.
- Digital input.

Key	Display	Comments
   	<div style="border: 1px solid black; padding: 5px; margin-bottom: 10px;">                     POSITION                      SET POINT                      DEVIATION                      → TEMPERATURE                 </div>	Select a monitoring attribute using the down arrow key and press <b>ENTER</b> .  Additional monitor selections are: <i>Input air supply</i> <i>Output air O1 port</i> <i>Output air O2 port</i> <i>Air pres</i> <i>Travel</i> <i>Reverse</i> <i>Digital input</i>
	<div style="border: 1px solid black; padding: 5px;">                     ID TAGNAME                      MON. VARIABLE                      nnn.nnUNITS                      GOOD STATUS                 </div>	Shows a real-time value for the selected variable.
	<div style="border: 1px solid black; padding: 5px;">                     ID TAGNAME                       READY                 </div>	



# APPENDIX B - EBTH TEMPERATURE TRANSMITTER

## INTRODUCTION

This appendix covers the configuration and calibration functions of the EBTH Smart Temperature Transmitter.

Refer to **OPERATING PROCEDURES** in Section 4 for information on the following functions:

- Send configurations.
- Get configurations.
- View configurations.
- Select configurations.
- Erase configurations.
- Operational functions.

**NOTE:** To change calibration or configuration parameters of a smart field device that is connected to an IMFBS01 module, the device must be taken off-line. This is done at the INFI 90 OPEN console.

## CREATE/MODIFY CONFIGURATION

This section details the configuration process for EBTH transmitters. Figure B-1 provides an overview of the configuration process. The following table details the configuration process.

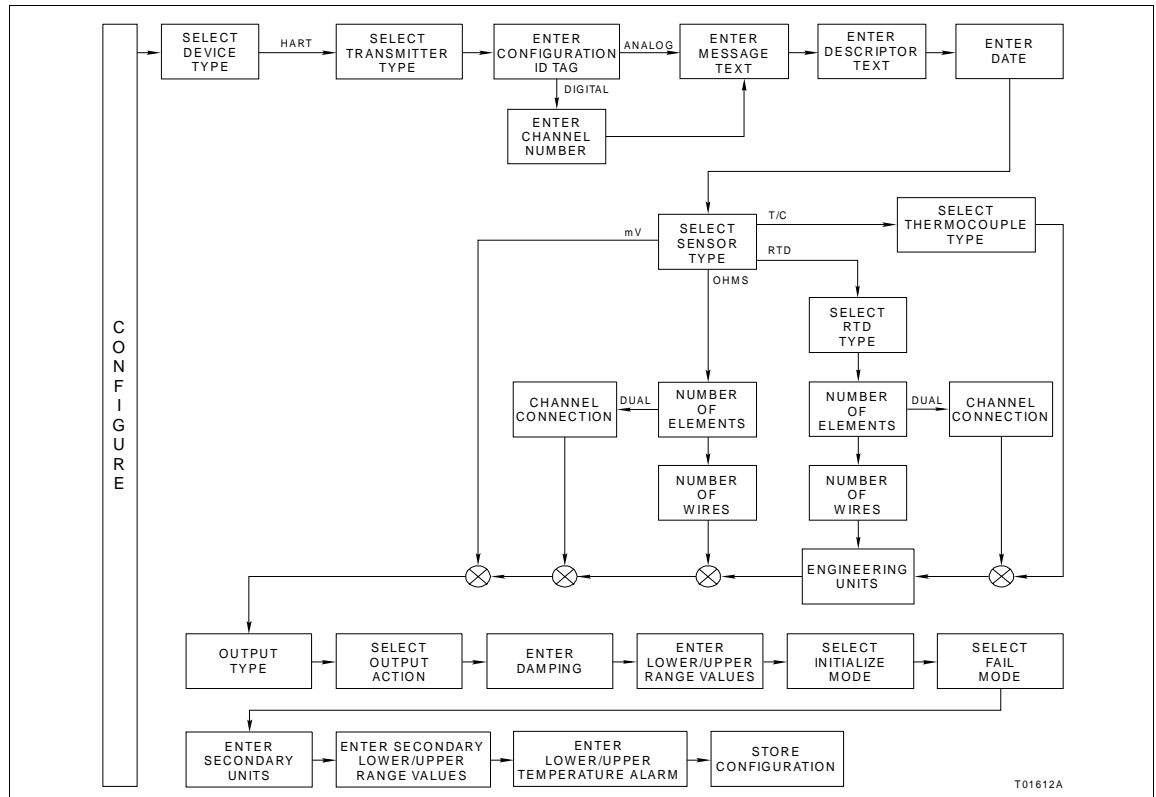









Figure B-1. Configuration Flowchart (EBTH)

# EBTH TEMPERATURE TRANSMITTER

Key	Display	Comments
	<div style="border: 1px solid black; padding: 5px;">           CONFIGURATION            → NEW            MODIFY            ERASE         </div>	<p>Select <i>NEW</i> to create a new configuration. To modify an existing configuration, select <i>MODIFY</i>. The screen sequence is the same, however, the <i>MODIFY</i> screens will appear with the values and cursor positions as originally configured.</p>
	<div style="border: 1px solid black; padding: 5px;">           DEVICE TYPE             ABB FSK            → HART         </div>	<p>Select <i>HART</i>.</p>
	<div style="border: 1px solid black; padding: 5px;">           TRANSMITTER TYPE            PTH → EBTH            TB82 pH      TB82 ORP            TB82 pION    TB82 CONC         </div>	<p>Select <i>EBTH</i>.</p>
		
	<div style="border: 1px solid black; padding: 5px;">           STT04 CONFIGURATION            [                    ]             ←PREVIOUS      NEXT→         </div>	<p>Enter a name for the configuration ID tag using up to eight ASCII characters. To select a character, press the key that has the desired character. Continue to press the key until the desired character appears. Use the right arrow key to move to the next character. Use the left arrow key to go back to the previous character.</p>
	<div style="border: 1px solid black; padding: 5px;">           SELECT MODE:            → ANALOG            DIGITAL         </div>	<p>For this example select <i>ANALOG</i>.</p>
	<div style="border: 1px solid black; padding: 5px;">           MESSAGE:             ←PREVIOUS      NEXT→         </div>	<p>Type a descriptive message using up to 32 characters. This field can be used to note anything of importance to the device or installation.</p> <p>To select a character, press the key that has the desired character. Continue to press the key until the desired character appears. Use the right arrow key to move to the next character. Use the left arrow key to go back to the previous character.</p>
	<div style="border: 1px solid black; padding: 5px;">           DESCRIPTOR:             ←PREVIOUS      NEXT→         </div>	<p>Type a descriptor string using up to 16 characters. This field can be used for notations about the device or process.</p> <p>To select a character, press the key that has the desired character. Continue to press the key until the desired character appears. Use the right arrow key to move to the next character. Use the left arrow key to go back to the previous character.</p>

Key	Display	Comments
ENTER	DATE: DAY: nn MONTH: nn YEAR: nnnn	Enter a day and press <b>ENTER</b> . Enter a month and press <b>ENTER</b> . Enter a year and press <b>ENTER</b> .  This date can represent the creation date of the configuration, the date the device or element was installed, or some other significant date.
ENTER	SENSOR TYPE: → T/C    RTD mV    OHMS	For this example select T/C.
ENTER	THERMOCOUPLE → N    B    E J    K    R S    T    C	Select N type.
ENTER	ENGINEERING UNIT → °C    °K °F    °R	Choose the desired temperature unit.
ENTER	OUTPUT TYPE: → LINEAR FUNC GENERATOR	Select <i>LINEAR</i> .  If <i>FUNC GENERATOR</i> is selected, specify 19 input and output points between 0 and 100%.
ENTER	OUTPUT ACTION: → NORMAL REVERSE	Refer to the <b>Platinum Standard Series Smart Temperature Transmitter EBTH</b> instruction for description.
ENTER	DAMPING: (0-32 SEC)  nn.nn SECS	Enter a value between 0 and 100. Refer to the <b>Platinum Standard Series Smart Temperature Transmitter EBTH</b> instruction for description.

# EBTH TEMPERATURE TRANSMITTER

Key	Display	Comments
ENTER	LOWER RANGE VAL nn.nn °C UPPER RANGE VAL nn.nn °C	Enter the lower range temperature value and press <b>ENTER</b> . Input the upper range value.
ENTER		
ENTER	INITIALIZE MODE: → LOW HIGH	Select an initialization mode using the arrow keys.  Refer to the <i>Platinum Standard Series Smart Temperature Transmitter EBTH</i> instruction for description.
ENTER	FAIL MODE: → LOW HIGH LAST	Select a fail mode using the arrow keys.  Refer to the <i>Platinum Standard Series Smart Temperature Transmitter EBTH</i> instruction for description.
ENTER	ENTER SECONDARY UNITS nnnnnn	Enter up to 6 characters. Use familiar units to describe the output.  To select a character, press the key that has the desired character. Continue to press the key until the desired character appears. Use the right arrow key to move to the next character. Use the left arrow key to go back to the previous character.
ENTER	SECONDARY L.R. _nn.nn UNITS SECONDARY U.R. nn.nn UNITS	Input the lower range value and press <b>ENTER</b> . Input the upper range value.
ENTER		
ENTER	LOWER TEMP ALARM _nn.nn UNITS UPPER TEMP ALARM. nn.nn UNITS	Input the lower temperature alarm value and press <b>ENTER</b> . Input the upper temperature alarm value and press <b>ENTER</b> .
ENTER		

Key	Display	Comments
<p>ENTER</p> <p>↓</p> <p>ENTER</p>	<p>STORE THIS CONFIGURATION NO → YES</p> <p>ID TAGNAME</p> <p>READY</p>	<p>Select YES.</p> <p>Configuration ID tag name just configured will be in the upper left corner if the configuration is saved. It becomes the working configuration.</p>

**CALIBRATION**

This section details the EBTH temperature transmitter calibration functions of the STT04 terminal. There are two types of calibration functions:

- Bench calibration.
- D-to-A adjust.

**NOTES:**

1. When calibrating, a field device must be connected to the STT04 terminal.
2. To change calibration or configuration parameters of a field device that is connected to an IMFBS01 module, the transmitter must be taken off-line. This is done at the INFI 90 OPEN console.

Refer to Figure B-2 for an overview of the calibration functions.

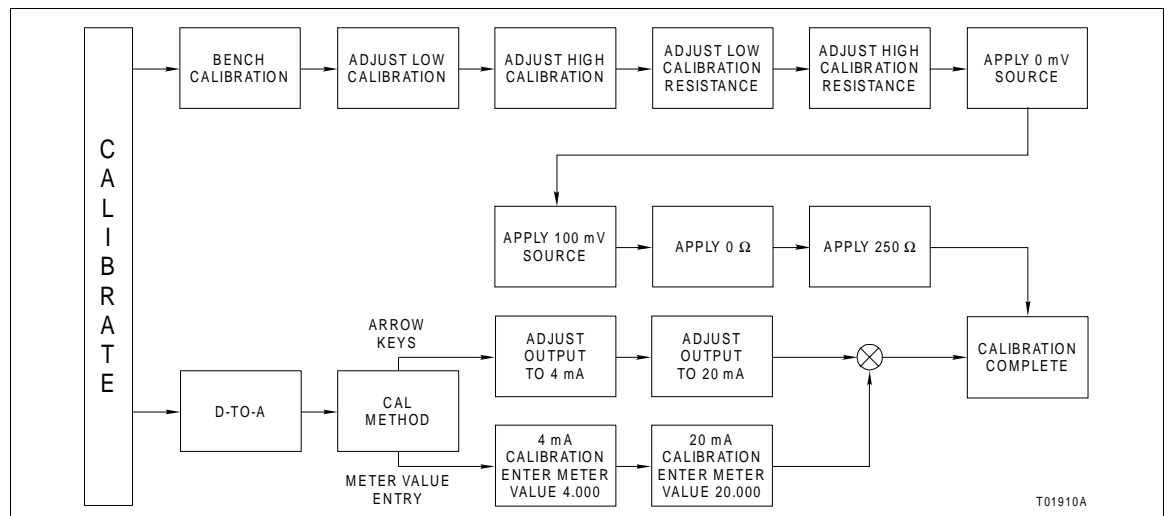

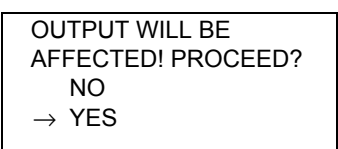

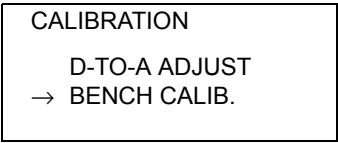

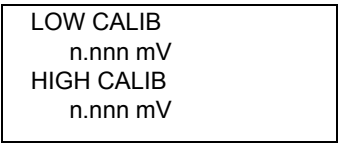

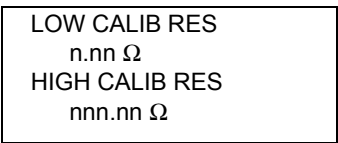

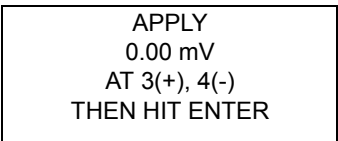
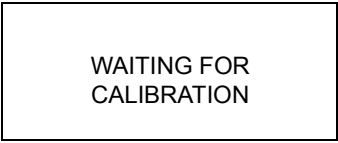





Figure B-2. Calibration Flowchart (EBTH)

# EBTH TEMPERATURE TRANSMITTER

## Bench Calibration

This procedure applies to EBTH Transmitters configured for either *ANALOG* or *DIGITAL*. Any difference between the two are noted in the **Comments** column.

Key	Display	Comments
		<p>This operation will cause a change in output not corresponding to the input. Be sure the control loop is in manual.</p> <p>Select <b>YES</b>.</p>
		
		<p>Select <b>BENCH CALIB</b> with the down arrow key.</p>
		
		<p>Enter the low and high calibration voltages.</p>
		<p>Enter the low and high calibration resistances.</p>
		<p>Apply 0.00 mV to the transmitter. A message appears that indicates a stabilization time.</p> <p><b>NOTE:</b> Refer to the EBTH instruction for detailed wiring diagrams of this procedure.</p>
		

Key	Display	Comments
	<div style="border: 1px solid black; padding: 5px; text-align: center;">                     APPLY                      100.00 mV                      AT 3(+), 4(-)                      THEN HIT ENTER                 </div>	Apply 100 mV to the transmitter. A message appears that indicates a stabilization time.  <b>NOTE:</b> Refer to the EBTH instruction for detailed wiring diagrams of this procedure.
	<div style="border: 1px solid black; padding: 5px; text-align: center;">                     WAITING FOR                      CALIBRATION                 </div>	
	<div style="border: 1px solid black; padding: 5px; text-align: center;">                     APPLY 0.00 Ω                      SHORT                      1-2, 2-3, 3-4                      THEN HIT ENTER                 </div>	Apply 0 Ω to the transmitter. A message appears that indicates a stabilization time.  <b>NOTE:</b> Refer to the EBTH instruction for detailed wiring diagrams of this procedure.
	<div style="border: 1px solid black; padding: 5px; text-align: center;">                     APPLY 250 Ω                      SHORT 1-2, 3-4                      Ω AT 2-3                      THEN HIT ENTER                 </div>	Apply 250 Ω to the transmitter. A message appears that indicates a stabilization time.  <b>NOTE:</b> Refer to the EBTH instruction for detailed wiring diagrams of this procedure.
	<div style="border: 1px solid black; padding: 5px; text-align: center;">                     ID TAGNAME                       READY                 </div>	

***D-to-A Adjust***







The *D-TO-A ADJUST* selection is only present when you are in the *ANALOG* communication mode. There are two methods available to adjust the four to 20 milliampere output:

- Arrow key.
- Meter value entry for HART devices.

# EBTH TEMPERATURE TRANSMITTER

## ARROW KEY ADJUSTMENT









Use this function to adjust the four to 20 milliampere output of the field device using the up and down arrow keys.

Key	Display	Comments
 	OUTPUT WILL BE AFFECTED! PROCEED? NO → YES	This operation will cause a change in output not corresponding to the input. Be sure the control loop is in manual.  Select <i>YES</i> .
	CALIBRATION → D-TO-A ADJUST BENCH CALIB.	Select <i>D-TO-A ADJUST</i> .
	D/A CAL USING → UPDOWN ARROW KEYS METER VALUE ENTRY	Select <i>UPDOWN ARROW KEYS</i> .
	ADJUST TO 4 mA  THEN HIT ENTER	Use the arrow keys to adjust the 4 mA signal.  <b>NOTE:</b> When increasing or decreasing the mA signal, the increments of change increase with successive depressions until the maximum level of change is reached. By changing direction you will return to the smallest increment of change. This adjustment technique speeds up the adjustment process without affecting fine adjustment.
	ADJUST TO 20 mA  THEN HIT ENTER	Use the arrow keys to adjust the 20 mA signal.
	ID TAGNAME  READY	



**METER VALUE ADJUSTMENT**

Use this function to adjust the four to 20 milliampere output of the field device using values from an external current meter. This method is only valid for HART devices.

Key	Display	Comments
 	<p>OUTPUT WILL BE AFFECTED! PROCEED? NO → YES</p>	<p>This operation will cause a change in output not corresponding to the input. Be sure the control loop is in manual. Select <i>YES</i>.</p>
	<p>CALIBRATION → D-TO-A ADJUST BENCH CALIB.</p>	<p>Select <i>D-TO-A ADJUST</i>.</p>
 	<p>D/A CAL USING UPDOWN ARROW KEYS → METER VALUE ENTRY</p>	<p>Select <i>METER VALUE ENTRY</i>.</p>
	<p>4 mA CALIBRATION: ENTER METER VALUE 4.000</p>	<p>Use the number keys to enter the current meter reading.</p>
	<p>20 mA CALIBRATION: ENTER METER VALUE 20.000</p>	<p>Use the number keys to enter the current meter reading.</p>
	<p>ID TAGNAME  READY</p>	

# APPENDIX C - EQS TEMPERATURE TRANSMITTER

## INTRODUCTION

This appendix covers the configuration and calibration functions of the EQS Temperature Transmitter. Refer to **OPERATING PROCEDURES** in Section 4 for information on the following functions:

- Send configurations.
- Get configurations.
- View configurations.
- Select configurations.
- Erase configurations.
- Operational functions.

**NOTE:** To change calibration or configuration parameters of a smart field device that is connected to an IMFBS01 module, the device must be taken off-line. This is done at the INFI 90 OPEN console.

## CREATE/MODIFY CONFIGURATION

Configuration can be created off-line, without a connected field device. Refer to Figure C-1 for an overview of the configuration function. The following table details the configuration process.

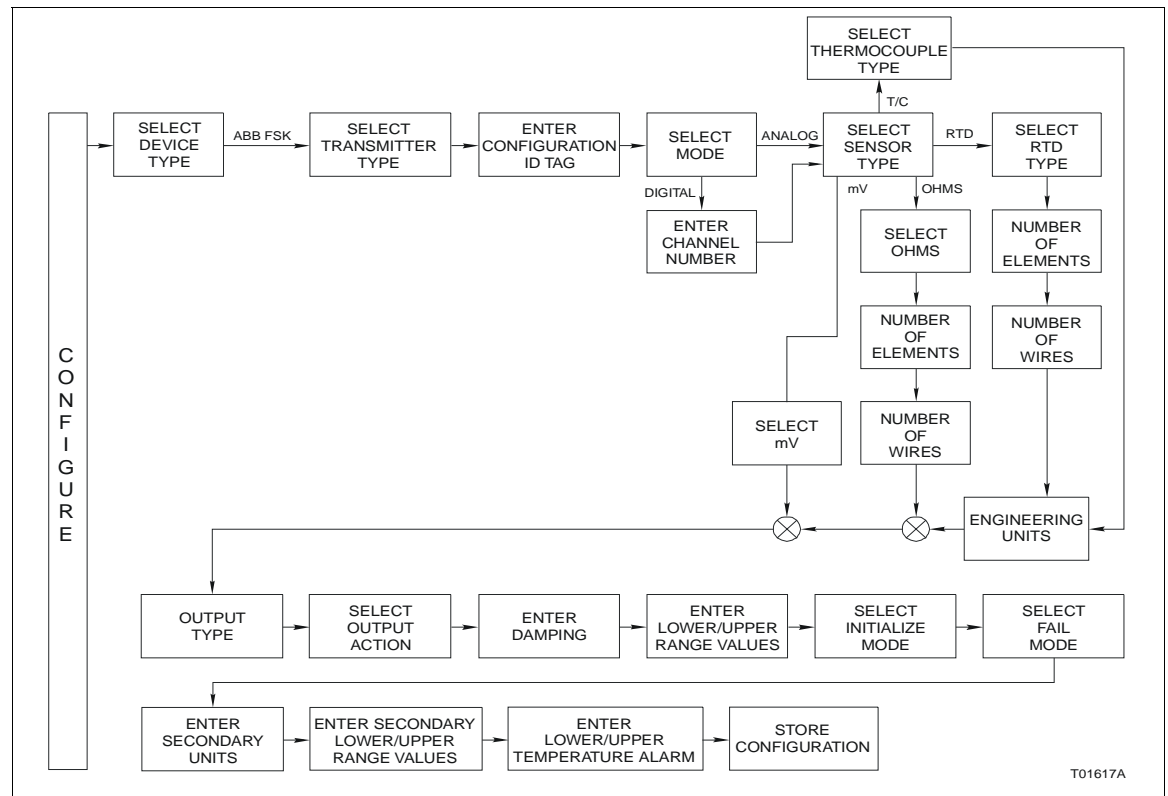











Figure C-1. Configuration Flowchart (EQS)





# EQS TEMPERATURE TRANSMITTER

Key	Display	Comments
	CONFIGURATION → NEW MODIFY ERASE	Select <i>NEW</i> to create a new configuration. To modify an existing configuration, select <i>MODIFY</i> . The screen sequence is the same, however, the <i>MODIFY</i> screens will appear with the values and cursor positions as originally configured.
	DEVICE TYPE → ABB FSK HART	Select <i>ABB FSK</i> .
	TRANSMITTER TYPE PTS → EQS BCN EQN AVS TB480 cond	Use the right arrow key to select <i>EQS</i> .
		
	STT04 CONFIGURATION [                    ] ←PREVIOUS      NEXT→	Enter a name for the configuration ID tag using up to 14 ASCII characters. To select a character, press the key that has the desired character. Continue to press the key until the desired character appears. Use the right arrow key to move to the next character. Use the left arrow key to go back to the previous character.
	SELECT MODE: → ANALOG DIGITAL	For this example select <i>ANALOG</i> .
	SENSOR TYPE: → T/C    RTD mV   OHMS	For this example select <i>T/C</i> .
	THERMOCOUPLE → N   B   E J   K   R S   T   C	Select <i>N</i> type.
	ENGINEERING UNIT → °C °F °K	Choose the desired temperature unit.

Key	Display	Comments
ENTER	OUTPUT TYPE: → LINEAR FUNC GENERATOR	Select <i>LINEAR</i> .  If <i>FUNC GENERATOR</i> is selected, specify 5 input and output points between 0 and 100%.
ENTER	OUTPUT ACTION: → NORMAL REVERSE	Refer to the <i>Platinum Standard Series Smart Temperature Transmitter EQS</i> instruction for description.
ENTER	DAMPING: (0-32 SEC)  nn.nn SECS	Enter a value between 0 and 32. Refer to the <i>Platinum Standard Series Smart Temperature Transmitter EQS</i> instruction for description.
ENTER	LOWER RANGE VAL nn.nn °C UPPER RANGE VAL nn.nn °C	Enter the lower range temperature value and press <b>ENTER</b> . Input the upper range value.
ENTER	INITIALIZE MODE: → LOW HIGH	Select an initialization mode using the arrow keys.  Refer to the <i>Platinum Standard Series Smart Temperature Transmitter EQS</i> instruction for description.
ENTER	FAIL MODE: → LOW HIGH LAST	Select a fail mode using the arrow keys.  Refer to the <i>Platinum Standard Series Smart Temperature Transmitter EQS</i> instruction for description.
ENTER	ENTER SECONDARY UNITS nnnnnn	Enter up to 6 characters. Use familiar units to describe the output.  To select a character, press the key that has the desired character. Continue to press the key until the desired character appears. Use the right arrow key to move to the next character. Use the left arrow key to go back to the previous character. Press <b>ENTER</b> when finished.
ENTER	SECONDARY L.R. _nn.nn UNITS SECONDARY U.R. nn.nn UNITS	Input the lower range value and press <b>ENTER</b> . Input the upper range value.

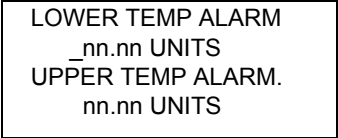
## EQS TEMPERATURE TRANSMITTER

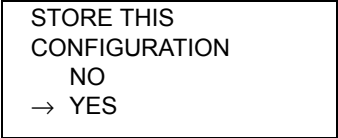
---

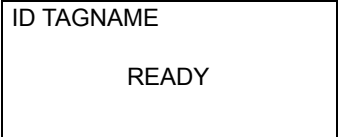
Key	Display	Comments
		Input the lower and upper temperature alarm values and press <b>ENTER</b> .  Lower and upper temperature alarms are user configured. The temperature is based on the cell. The default alarm settings are shown here. The defaults are also the lower and upper limits of the alarm.
		Select YES.
		
		

---

### CALIBRATION

This section details the EQS temperature transmitter calibration functions of the STT04 terminal. There are two types of calibration functions:

- Bench calibration.
- D-to-A adjust.

**NOTES:**

1. When calibrating, a field device must be connected to the STT04 terminal.
2. To change calibration or configuration parameters of a field device that is connected to an IMFBS01 module, the transmitter must be taken off-line. This is done at the INFI 90 OPEN console.

Refer to Figure C-2 for an overview of the calibration functions.

---

#### Bench Calibration

This procedure applies to EQS Transmitters configured for either *ANALOG* or *DIGITAL*. Any differences between the two are noted in the **Comments** column.

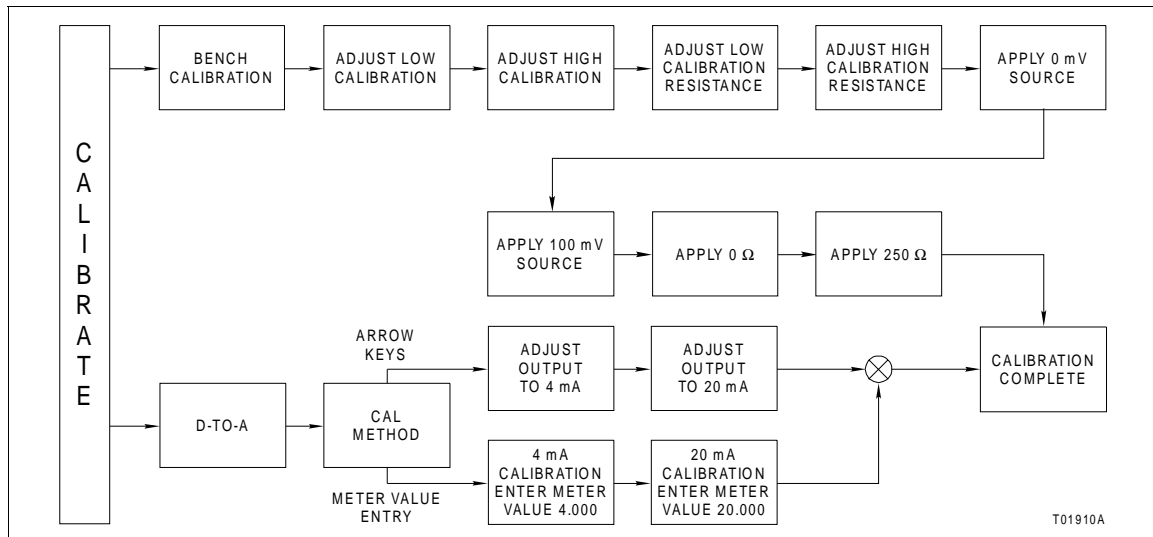

Figure C-2. Calibration Flowchart (EQS)







Key	Display	Comments
<div style="border: 1px solid black; padding: 2px; width: 30px; text-align: center;">CALI-BRATE</div>	<div style="border: 1px solid black; padding: 5px;">                     OUTPUT WILL BE AFFECTED! PROCEED?                      NO                      → YES                 </div>	This operation will cause a change in output not corresponding to the input. Be sure the control loop is in manual.  Select YES.
<div style="border: 1px solid black; padding: 2px; width: 30px; text-align: center;">↓</div>	<div style="border: 1px solid black; padding: 5px;">                     CALIBRATION                       D-T-O-A ADJUST                      → BENCH CALIB.                 </div>	Select <i>BENCH CALIB</i> with the down arrow key.
<div style="border: 1px solid black; padding: 2px; width: 30px; text-align: center;">ENTER</div>	<div style="border: 1px solid black; padding: 5px;">                     LOW CALIB                      n.nnn mV                      HIGH CALIB                      n.nnn mV                 </div>	Enter the low and high calibration voltages.
<div style="border: 1px solid black; padding: 2px; width: 30px; text-align: center;">↓</div>	<div style="border: 1px solid black; padding: 5px;">                     LOW CALIB RES                      n.nn Ω                      HIGH CALIB RES                      nnn.nn Ω                 </div>	Enter the low and high calibration resistances.
<div style="border: 1px solid black; padding: 2px; width: 30px; text-align: center;">ENTER</div>	<div style="border: 1px solid black; padding: 5px;">                     LOW CALIB RES                      n.nn Ω                      HIGH CALIB RES                      nnn.nn Ω                 </div>	Enter the low and high calibration resistances.

## EQS TEMPERATURE TRANSMITTER

Key	Display	Comments
ENTER	APPLY 0.00 mV AT 3(+), 4(-) THEN HIT ENTER	Apply 0.00 mV to the transmitter.  <b>NOTE:</b> Refer to the EQS instruction for detailed wiring diagrams of this procedure.
ENTER	APPLY 100.00 mV AT 3(+), 4(-) THEN HIT ENTER	Apply 100 mV to the transmitter.
ENTER	APPLY 0.00 $\Omega$ SHORT 1-2, 2-3, 3-4 THEN HIT ENTER	Apply 0 $\Omega$ to the transmitter.  <b>NOTE:</b> Refer to the EQS instruction for detailed wiring diagrams of this procedure.
ENTER	APPLY 250 $\Omega$ SHORT 1-2, 3-4 $\Omega$ AT 2-3 THEN HIT ENTER	Apply 250 $\Omega$ to the transmitter.
ENTER	ADJUST TO 4 mA  THEN HIT ENTER	Use the arrow keys to adjust the 4 mA signal.  <b>NOTE:</b> When increasing or decreasing the mA signal, the increments of change increase with successive depressions until the maximum level of change is reached. By changing direction you will return to the smallest increment of change. This adjustment technique speeds up the adjustment process without affecting fine adjustment.
ENTER	ADJUST TO 20 mA  THEN HIT ENTER	Use the arrow keys to adjust the 20 mA signal.
ENTER	ID TAGNAME  READY	

**D-to-A Adjust**

The *D-TO-A ADJUST* selection is only present when you are in the *ANALOG* communication mode, specified in the configuration procedure. This selection allows you to adjust the four to 20 milliampere output of the field device.

Key	Display	Comments
 	<div style="border: 1px solid black; padding: 5px;">                     OUTPUT WILL BE                      AFFECTED! PROCEED?.                      NO                      → YES                 </div>	This operation will cause a change in output not corresponding to the input. Be sure the control loop is in manual.  Select <i>YES</i> .
	<div style="border: 1px solid black; padding: 5px;">                     CALIBRATION                      → D-TO-A ADJUST                      BENCH CALIB.                 </div>	Select <i>D-TO-ADJUST</i> .
	<div style="border: 1px solid black; padding: 5px;">                     ADJUST TO 4 mA                       THEN HIT ENTER                 </div>	Use the arrow keys to adjust the 4 mA signal.  <b>NOTE:</b> When increasing or decreasing the mA signal, the increments of change increase with successive depressions until the maximum level of change is reached. By changing direction you will return to the smallest increment of change. This adjustment technique speeds up the adjustment process without affecting fine adjustment.
	<div style="border: 1px solid black; padding: 5px;">                     ADJUST TO 20 mA                       THEN HIT ENTER                 </div>	Use the arrow keys to adjust the 20 mA signal.
	<div style="border: 1px solid black; padding: 5px;">                     ID TAGNAME                       READY                 </div>	



# APPENDIX D - PTH PRESSURE TRANSMITTER

## INTRODUCTION

This appendix covers the configuration and calibration functions of the PTH Pressure Transmitter.

Refer to **OPERATING PROCEDURES** in Section 4 for information on the following functions:

- Send configurations.
- Get configurations.
- View configurations.
- Select configurations.
- Erase configurations.
- Operational functions.

**NOTE:** To change calibration or configuration parameters of a smart field device that is connected to an IMFBS01 module, the device must be taken off-line. This is done at the INFI 90 OPEN console.

## CREATE/MODIFY CONFIGURATION

A configuration can be created off-line, without a connected field device. Refer to Figure D-1 for an overview of the configuration function. The following table details the configuration process.

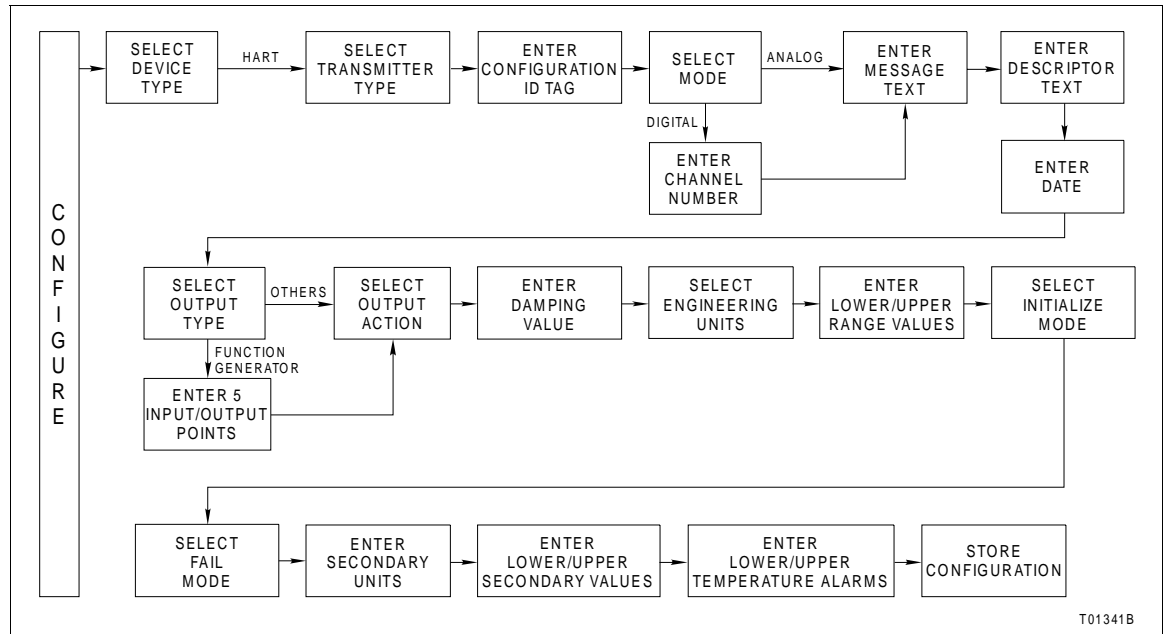









Figure D-1. Configuration Flowchart (PTH)

# PTH PRESSURE TRANSMITTER

Key	Display	Comments
	CONFIGURATION → NEW MODIFY ERASE	Select <i>NEW</i> to create a configuration. To modify an existing configuration, select <i>MODIFY</i> . The screen sequence is the same, however, the <i>MODIFY</i> screens will appear with the values and arrow positions as they were originally configured.
	DEVICE TYPE ABB FSK → HART	Select <i>HART</i> .
		
	TRANSMITTER TYPE →PTH           EBTH TB82 pH       TB82 ORP TB82 pION    TB82 CONC	Select <i>PTH</i> .
	STT04 CONFIGURATION [                    ] ←PREVIOUS       NEXT→	Enter a name for the configuration ID tag using up to eight ASCII characters. To select a character, press the key that has the desired character. Continue to press the key until the desired character appears. Use the right arrow key to move to the next character. Use the left arrow key to go back to the previous character.
	SELECT MODE: → ANALOG DIGITAL	Select <i>ANALOG</i> .  <b>NOTE:</b> The <i>DIGITAL</i> selection should only be made when using the device in the multidrop. A <i>CHANNEL #</i> prompt appears when <i>DIGITAL</i> is selected.
	MESSAGE: ←PREVIOUS       NEXT→	Type a descriptive message using up to 32 characters. This field can be used to note anything of importance to the device or installation.  To select a character, press the key that has the desired character. Continue to press the key until the desired character appears. Use the right arrow key to move to the next character. Use the left arrow key to go back to the previous character.
	DESCRIPTOR: ←PREVIOUS       NEXT→	Type a descriptor string using up to 16 characters. This field can be used for notations about the device or process.  To select a character, press the key that has the desired character. Continue to press the key until the desired character appears. Use the right arrow key to move to the next character. Use the left arrow key to go back to the previous character.

Key	Display	Comments
<p>ENTER</p> <p>ENTER</p>	<p>DATE: DAY: nn MONTH: nn YEAR: nn</p>	<p>Enter a day and press <b>ENTER</b>. Enter a month and press <b>ENTER</b>. Enter a year and press <b>ENTER</b>.</p> <p>This date can represent the creation date of the configuration, the date the device or element was installed, or some other significant date.</p>
<p>ENTER</p>	<p>OUTPUT TYPE → LINEAR SQUARE ROOT 3/2 FLOW MODE</p>	<p>Select <i>LINEAR</i>.</p> <p>In this example <i>FUNC GENERATOR</i> is chosen as an output. Specify five input and output points as a percentage of input. The first and last points on the curve are fixed at 0.00% and 100.00%. The 5 points are to be between these values.</p> <p><b>NOTE:</b> Other output type selections not shown here include <i>LINEAR</i>, <i>SQUARE ROOT</i>, <i>VOL./ SPHERE</i> and <i>VOL./CYLINDER</i>.</p>
<p>ENTER</p>	<p>OUTPUT ACTION: → NORMAL REVERSE</p>	<p>Use <b>BACK</b> to return to a previous configuration screen from any screen in the configuration process.</p> <p>Select an output action.</p>
<p>ENTER</p>	<p>DAMPING: (0 - 32 SEC)  _ n.nn SECS</p>	<p>Enter a value between 0 and 32 seconds.</p>
<p>ENTER</p>	<p>ENGINEERING UNIT → iH2O mmH2O mmHg PSI BARS mBAR Kgcm<sup>2</sup> KPA</p>	<p>Select an engineering unit best suited for the application.</p>
<p>ENTER</p>	<p>LOWER RANGE VAL nn.nn UNITS UPPER RANGE VAL nn.nn UNITS</p>	<p>Input lower range value using the arrow keys, then press <b>ENTER</b>. Input the upper range value.</p>

# PTH PRESSURE TRANSMITTER

Key	Display	Comments
ENTER	INITIALIZE MODE: → LOW HIGH	Refer to the <i>Platinum Standard Series Smart Pressure Transmitter PTH</i> instruction for mode description.
ENTER	FAIL MODE: → LOW HIGH LAST	Make a selection using the arrow keys.
ENTER	ENTER SECONDARY UNITS _nnnnnn	This is a 6-character alphanumeric designation to represent values in user familiar units.  To select a character, press the key that has the desired character. Continue to press the key until the desired character appears. Use the right arrow key to move to the next character. Use the left arrow key to go back to the previous character.
ENTER	SECONDARY L. R. nn.nn UNITS SECONDARY U. R. nn.nn UNITS	Specify values using the number keypad. The <i>UNITS</i> displayed will be those designated in the previous screen. After entering value press <b>ENTER</b> .
ENTER	LOWER TEMP ALARM -40.00°C UPPER TEMP ALARM 85.00°C	Lower and upper temperature alarms are user configurable alarms. The temperature is based on the cell. The default alarms setting are shown here. The defaults are also the lower and upper limits of the alarm.
ENTER	STORE THIS CONFIGURATION? NO → YES	<b>NOTE:</b> Use <b>BACK</b> to return to a previous configuration screen from any screen in the configuration process.
↓		Select <b>YES</b> .
ENTER	ID TAGNAME READY	

**CALIBRATION**

This section details the PTH pressure transmitter calibration functions using an STT04 terminal. There are three types of calibration functions:

- Bench calibration.
- Rezero.
- D-to-A adjust.

**NOTES:**

1. When calibrating, a field device must be connected to the STT04 terminal.
2. To change calibration or configuration parameters of a field device that is connected to an IMFBS01 module, the transmitter must be taken off-line. This is done at the INFI 90 OPEN console.

Refer to Figure D-2 for an overview of the calibration functions.

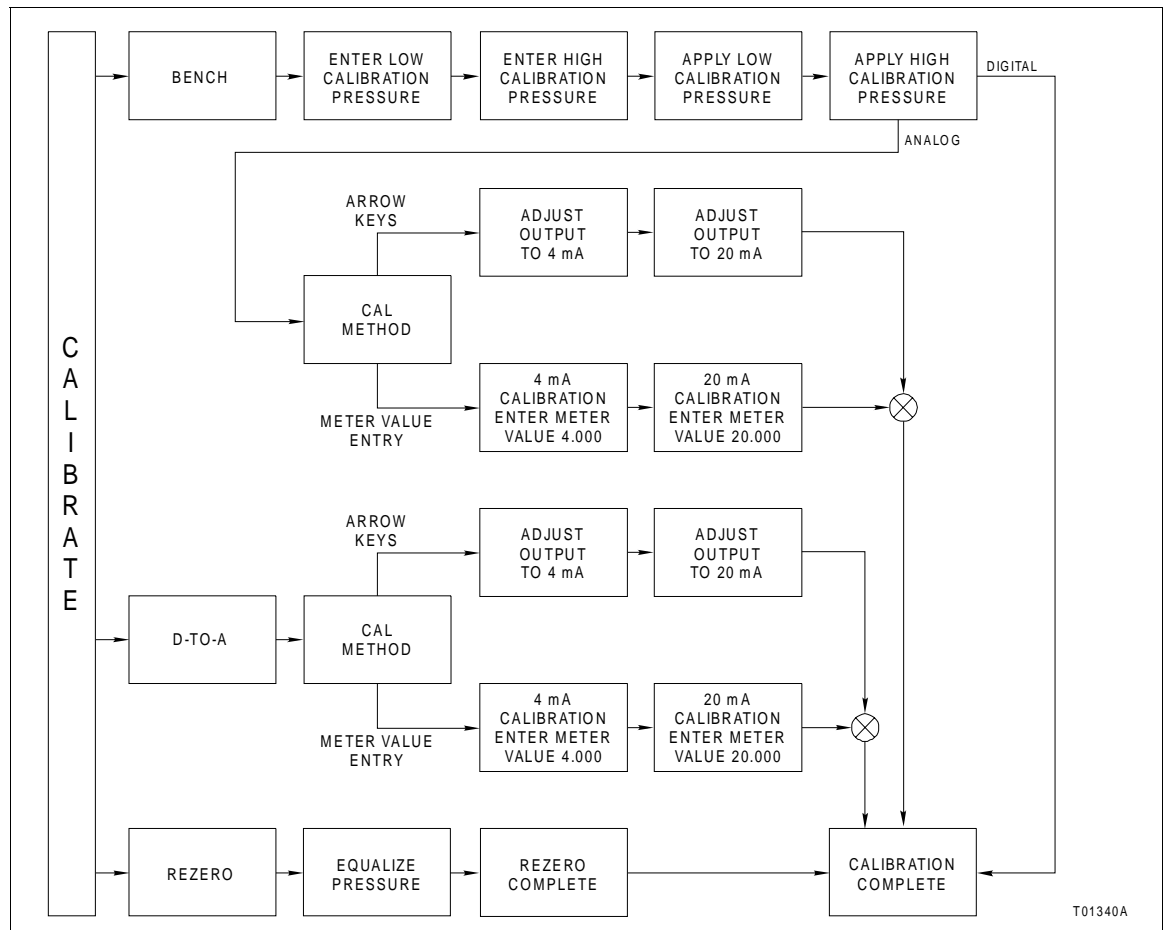













Figure D-2. Calibration Flowchart (PTH)

# PTH PRESSURE TRANSMITTER

## Bench Calibration

This procedure applies to PTH pressure transmitters configured for either *ANALOG* or *DIGITAL*. Any differences between the two are noted in the **Comments** column.







Key	Display	Comments
 	<div style="border: 1px solid black; padding: 5px;">                     OUTPUT WILL BE                      AFFECTED! PROCEED?                      NO                      → YES                 </div>	This operation will cause a change in output not corresponding to the input. Be sure the control loop is in manual.  Select <b>YES</b> .
 	<div style="border: 1px solid black; padding: 5px;">                     CALIBRATION                      D-TO-A ADJUST                      → BENCH CALIB.                      REZERO                 </div>	Select <b>BENCH CALIB.</b> If the transmitter is configured for digital operation, the <i>D-TO-A ADJUST</i> selection would not appear.
	<div style="border: 1px solid black; padding: 5px;">                     LOW CALIB PRESSURE                      nn.nn UNITS                      HIGH CALIB PRESSURE                      nn.nn UNITS                 </div>	Enter the low calibration pressure value and press <b>ENTER</b> . Enter the high calibration pressure value.
	<div style="border: 1px solid black; padding: 5px;">                     APPLY PRESSURE OF                      nn.nn UNITS                       THEN HIT ENTER                 </div>	Apply the low calibration pressure to the input of transmitter as specified earlier.
	<div style="border: 1px solid black; padding: 5px;">                     APPLY PRESSURE OF                      nn.nn UNITS                       THEN HIT ENTER                 </div>	Apply the high calibration pressure to the input of transmitter as specified earlier.

Key	Display	Comments
	<div style="border: 1px solid black; padding: 5px; text-align: center;">                     D/A CAL USING                      →UPDOWN ARROW KEYS                      METER VALUE ENTRY                 </div>	Select <i>UPDOWN ARROW KEYS</i> .  <b>NOTE:</b> Refer to <b>METER VALUE ADJUSTMENT</b> for details about meter value entry.
	<div style="border: 1px solid black; padding: 5px; text-align: center;">                     ADJUST TO 4 mA                       THEN HIT ENTER                 </div>	Adjust transmitter output using the up and down arrow keys. If configured digitally this adjust display does not appear.  <b>NOTE:</b> When increasing or decreasing the mA signal, the increments of change increase with successive depressions until the maximum level of change is reached. By changing direction the smallest increment of change returns. This technique speeds up the adjustment process without affecting fine adjustment.
	<div style="border: 1px solid black; padding: 5px; text-align: center;">                     ADJUST TO 20 mA                       THEN HIT ENTER                 </div>	Adjust the transmitter output using the up and down arrow keys.
	<div style="border: 1px solid black; padding: 5px; text-align: center;">                     ID TAGNAME                       READY                 </div>	

# PTH PRESSURE TRANSMITTER

## Rezero

The rezero procedure allows you to zero the transmitter without going through the complete bench calibration procedure.

Key	Display	Comments
 	<div style="border: 1px solid black; padding: 5px;">                     OUTPUT WILL BE                      AFFECTED! PROCEED?                      NO                      → YES                 </div>	This operation will cause a change in output not corresponding to the input. Be sure the control loop is in manual.  Select <b>YES</b> .
  	<div style="border: 1px solid black; padding: 5px;">                     CALIBRATION:                      D-TO-A ADJUST                      BENCH CALIB.                      → REZERO                 </div>	Select <b>REZERO</b> .  If digitally configured, the <i>D-TO-A ADJUST</i> selection will not appear.
	<div style="border: 1px solid black; padding: 5px;">                     APPLY PRESSURE OF                      nn.nn UNITS                       THEN HIT ENTER                 </div>	Apply zero value to the transmitter.
	<div style="border: 1px solid black; padding: 5px;">                     ID TAGNAME                       READY                 </div>	Rezero is complete.

## D-to-A Adjust









The *D-TO-A ADJUST* selection is only present when you are in the *ANALOG* communication mode. There are two methods available to adjust the four to 20 milliampere output:

- Arrow key.
- Meter value entry for HART devices.











**ARROW KEY ADJUSTMENT**

Use this function to adjust the four to 20 milliampere output of the field device using the up and down arrow keys.

Key	Display	Comments
 	<p>OUTPUT WILL BE AFFECTED! PROCEED? NO → YES</p>	<p>This operation will cause a change in output not corresponding to the input. Be sure the control loop is in manual. Select <i>YES</i>.</p>
	<p>CALIBRATION → D-TO-A ADJUST BENCH CALIB.</p>	<p>Select <i>D-TO-A ADJUST</i>.</p>
 	<p>D/A CAL USING → UPDOWN ARROW KEYS METER VALUE ENTRY</p>	<p>Select <i>UPDOWN ARROW KEYS</i>.</p>
	<p>ADJUST TO 4 mA  THEN HIT ENTER</p>	<p>Use the arrow keys to adjust the 4 mA signal.  <b>NOTE:</b> When increasing or decreasing the mA signal, the increments of change increase with successive depressions until the maximum level of change is reached. By changing direction you will return to the smallest increment of change. This adjustment technique speeds up the adjustment process without affecting fine adjustment.</p>
	<p>ADJUST TO 20 mA  THEN HIT ENTER</p>	<p>Use the arrow keys to adjust the 20 mA signal.</p>
	<p>ID TAGNAME  READY</p>	

**METER VALUE ADJUSTMENT**

Use this function to adjust the four to 20 milliampere output of the field device using values from an external current meter. This method is only valid for HART devices.

Key	Display	Comments
 	<p>OUTPUT WILL BE AFFECTED! PROCEED? NO → YES</p>	<p>This operation will cause a change in output not corresponding to the input. Be sure the control loop is in manual. Select <b>YES</b>.</p>
	<p>CALIBRATION → D-TO-A ADJUST BENCH CALIB.</p>	<p>Select <b>D-TO-A ADJUST</b>.</p>
 	<p>D/A CAL USING UPDOWN ARROW KEYS →METER VALUE ENTRY</p>	<p>Select <b>METER VALUE ENTRY</b>.</p>
	<p>4 mA CALIBRATION ENTER METER VALUE  THEN HIT ENTER</p>	<p>Use the number keys to enter the current meter reading.</p>
	<p>20 mA CALIBRATION ENTER METER VALUE  THEN HIT ENTER</p>	<p>Use the number keys to enter the current meter reading.</p>
	<p>ID TAGNAME  READY</p>	

# APPENDIX E - PTS PRESSURE TRANSMITTER

## INTRODUCTION

This appendix covers the configuration and calibration functions of the PTS Pressure Transmitter.

Refer to **OPERATING PROCEDURES** in Section 4 for information on the following functions:

- Send configurations.
- Get configurations.
- View configurations.
- Select configurations.
- Erase configurations.
- Operational functions.

**NOTE:** To change calibration or configuration parameters of a smart field device that is connected to an IMFBS01 module, the device must be taken off-line. This is done at the INFI 90 OPEN console.

## CREATE/MODIFY CONFIGURATION

A configuration can be created off-line, without a connected field device. Refer to Figure E-1 for an overview of the configuration function. The following table details the configuration process.

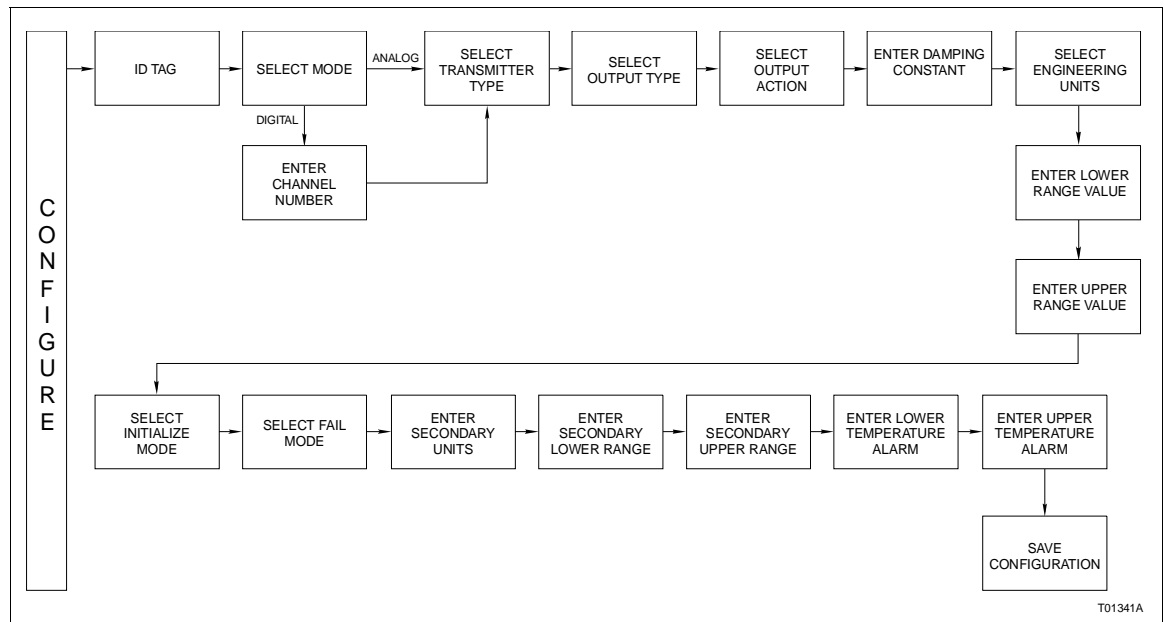





Figure E-1. Configuration Flowchart (PTS)



Key	Display	Comments
ENTER	ENGINEERING UNIT →iH20cmH2OmmHg PSIMPAKPA BARSmBARKgcm2	Select an engineering unit best suited for the application.
ENTER	LOWER RANGE VAL. nn.nn UNITS UPPER RANGE VAL. nn.nn UNITS	Input lower range value using the arrow keys, then press <b>ENTER</b> . Input the upper range value.
ENTER	INITIALIZE MODE: → LOW HIGH	Refer to the <i>Platinum Standard Series Smart Pressure Transmitter PTS</i> instruction for mode description.
ENTER	FAIL MODE: → LOW HIGH LAST	Make a selection using the arrow keys.
ENTER	ENTER SECONDARY UNITS _nnnnnn	This is a 6-character alphanumeric designation to represent values in user familiar units.  To select a character, press the key that has the desired character. Continue to press the key until the desired character appears. Use the right arrow key to move to the next character. Use the left arrow key to go back to the previous character. Press <b>ENTER</b> when finished.
ENTER	SECONDARY L. R. nn.nn UNITS SECONDARY U. R. nn.nn UNITS	Specify values using the number keypad. The <i>UNITS</i> displayed will be those designated in the previous screen. After entering value press <b>ENTER</b> .
ENTER	LOWER TEMP ALARM -40.00°C UPPER TEMP ALARM 85.00°C	Lower and upper temperature alarms are user configured. The temperature is based on the cell. The default alarms setting are shown here. The defaults are also the lower and upper limits of the alarm.
		<b>NOTE:</b> Use <b>BACK</b> to return to a previous configuration screen from any screen in the configuration process.

## PTS PRESSURE TRANSMITTER

---

Key	Display	Comments
  	<div style="border: 1px solid black; padding: 5px; margin-bottom: 10px;">STORE THIS CONFIGURATION? NO → YES</div> <div style="border: 1px solid black; padding: 5px;">ID TAGNAME READY</div>	Select YES.

---

### CALIBRATION

This section details the PTS pressure transmitter calibration functions using an STT04 terminal. There are three types of calibration functions:

- Bench calibration.
- Rezero.
- D-to-A adjust.

**NOTES:**

1. When calibrating, a field device must be connected to the STT04 terminal.
2. To change calibration or configuration parameters of a field device that is connected to an IMFBS01 module, the transmitter must be taken off-line. This is done at the INFI 90 OPEN console.

Refer to Figure E-2 for an overview of the calibration functions.

---

#### **Bench Calibration**

This procedure applies to PTS pressure transmitters configured for either *ANALOG* or *DIGITAL*. Any difference between the two are noted in the **Comments** column.

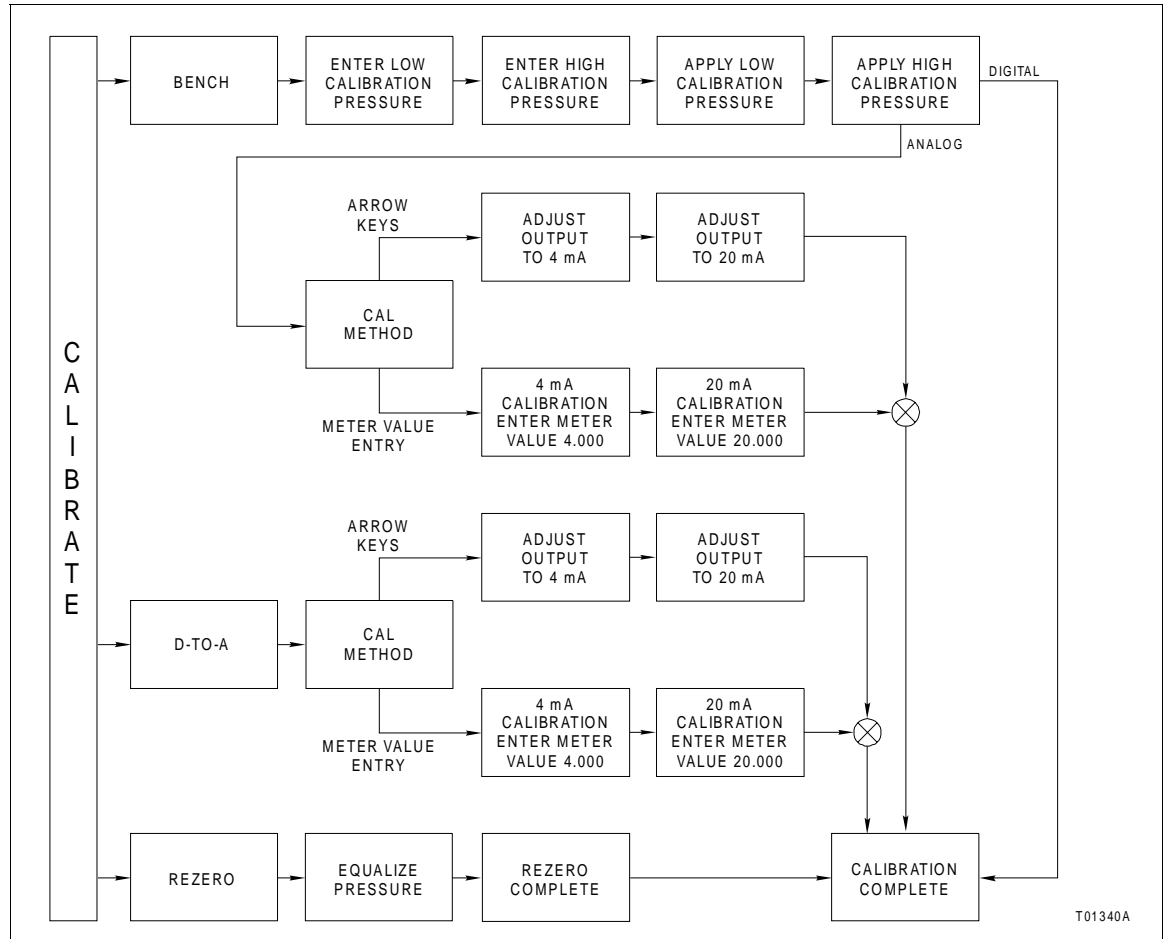













Figure E-2. Calibration Flowchart (PTS)

Key	Display	Comments
 	<p>OUTPUT WILL BE AFFECTED! PROCEED? NO → YES</p>	<p>This operation will cause a change in output not corresponding to the input. Be sure the control loop is in manual. Select YES.</p>
 	<p>CALIBRATION D-TO-A ADJUST → BENCH CALIB. REZERO</p>	<p>Select <i>BENCH CALIB.</i> If the transmitter is configured for digital operation, the <i>D-TO-A ADJUST</i> selection would not appear.</p>







# PTS PRESSURE TRANSMITTER

Key	Display	Comments
	<div style="border: 1px solid black; padding: 5px; text-align: center;">           LOW CALIB PRESSURE            nn.nn UNITS            HIGH CALIB PRESSURE            nn.nn UNITS         </div>	<p>Enter the low calibration pressure value and press <b>ENTER</b>. Enter the high calibration pressure value.</p>
	<div style="border: 1px solid black; padding: 5px; text-align: center;">           APPLY PRESSURE OF            nn.nn UNITS             THEN HIT ENTER         </div>	<p>Apply the low calibration pressure to the input of transmitter as specified earlier.</p>
	<div style="border: 1px solid black; padding: 5px; text-align: center;">           APPLY PRESSURE OF            nn.nn UNITS             THEN HIT ENTER         </div>	<p>Apply the high calibration pressure to the input of transmitter as specified earlier.</p>
	<div style="border: 1px solid black; padding: 5px; text-align: center;">           ADJUST TO 4 mA             THEN HIT ENTER         </div>	<p>Adjust transmitter output using the up and down arrow keys. If configured digitally this adjust display does not appear.</p>
	<div style="border: 1px solid black; padding: 5px; text-align: center;">           ADJUST TO 20 mA             THEN HIT ENTER         </div>	<p><b>NOTE:</b> When increasing or decreasing the mA signal, the increments of change increase with successive depressions until the maximum level of change is reached. By changing direction the smallest increment of change returns. This technique speeds up the adjustment process without affecting fine adjustment.</p>
	<div style="border: 1px solid black; padding: 5px; text-align: center;">           ADJUST TO 4 mA             THEN HIT ENTER         </div>	<p>Adjust the transmitter output using the up and down arrow keys.</p>
	<div style="border: 1px solid black; padding: 5px; text-align: center;">           ID TAGNAME             READY         </div>	









**Rezero**

The rezero procedure allows you to zero the transmitter without going through the complete bench calibration procedure.

Key	Display	Comments
 	<div data-bbox="597 428 930 569" style="border: 1px solid black; padding: 5px;">                     OUTPUT WILL BE                      AFFECTED! PROCEED?                      NO                      → YES                 </div>	This operation will cause a change in output not corresponding to the input. Be sure the control loop is in manual.  Select YES.
  	<div data-bbox="597 716 930 856" style="border: 1px solid black; padding: 5px;">                     CALIBRATION:                      D-TO-A ADJUST                      BENCH CALIB.                      → REZERO                 </div>	Select REZERO.  If digitally configured, the D-TO-A ADJUST selection will not appear.
	<div data-bbox="597 1121 930 1262" style="border: 1px solid black; padding: 5px;">                     APPLY PRESSURE                      OF                      nn.nn UNITS                      THEN HIT ENTER                 </div>	Apply zero value to the transmitter.
	<div data-bbox="597 1325 930 1465" style="border: 1px solid black; padding: 5px;">                     ID TAGNAME                      READY                 </div>	Rezero is complete.

**D-to-A Adjust**

The *D-TO-A ADJUST* selection is only present when you are in the *ANALOG* communication mode, specified in the configuration procedure. This selection allows you to adjust the four to 20 milliampere output of the field device.

Key	Display	Comments
 	<p>OUTPUT WILL BE AFFECTED! PROCEED? NO → YES</p>	<p>This operation will cause a change in output not corresponding to the input. Be sure the control loop is in manual. Select <i>YES</i>.</p>
	<p>CALIBRATION → D-TO-A ADJUST BENCH CALIB. REZERO</p>	<p>Select <i>D-TO-A ADJUST</i>.</p>
	<p>ADJUST TO 4 mA  THEN HIT ENTER</p>	<p>Use the arrow keys to adjust the 4 mA signal.  <b>NOTE:</b> When increasing or decreasing the mA signal, the increments of change increase with successive depressions until the maximum level of change is reached. By changing direction you will return to the smallest increment of change. This adjustment technique speeds up the adjustment process without affecting fine adjustment.</p>
	<p>ADJUST TO 20 mA  THEN HIT ENTER</p>	<p>Use the arrow keys to adjust the 20 mA signal.</p>
	<p>ID TAGNAME  READY</p>	

# APPENDIX F - HART UNIVERSAL

## INTRODUCTION

This appendix covers the universal HART configuration function. An STT04 can communicate with an unsupported HART device and edit the following fields; ID tag, device address, message and descriptor.

## HART UNIVERSAL CONFIGURATION

Refer to Figure F-1 for an overview of the HART configuration function. The table that follows details the configuration process.

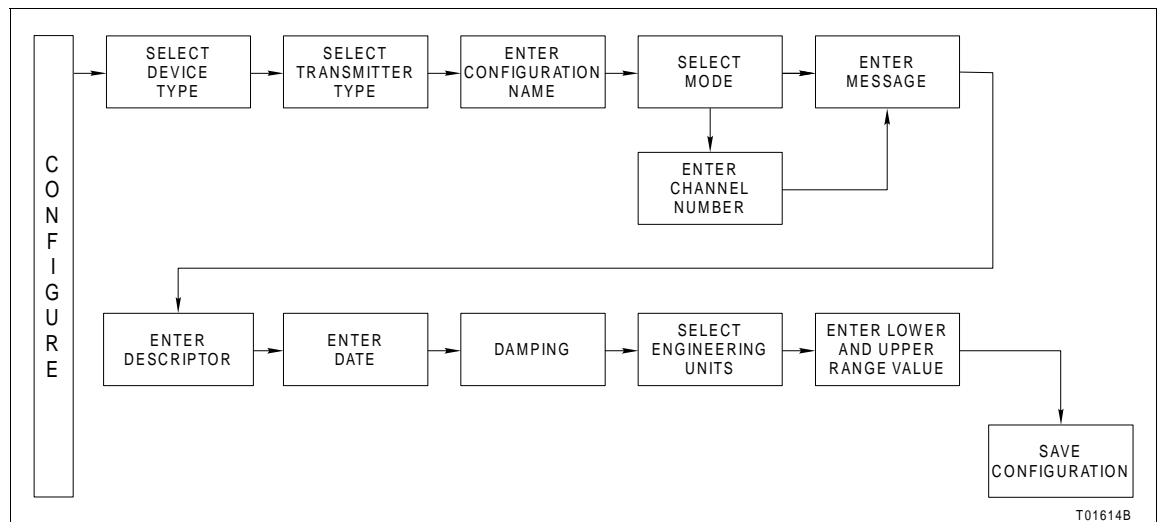

















Figure F-1. Configuration Flowchart (HART)

Key	Display	Comments
ENTER  ↓	DEVICE TYPE  ABB FSK → HART	Select HART.

Key	Display	Comments
    	<div style="border: 1px solid black; padding: 5px;">                     TRANSMITTER TYPE                      TB82 pH      TB82 ORP                      TB82 pION   TB82 CONC                      TZID/AZH → HART UNIV                 </div>	Select <i>HART UNIVERSAL</i> .
	<div style="border: 1px solid black; padding: 5px;">                     STT04 CONFIGURATION                      [                                ]                      ←PREVIOUS      NEXT→                 </div>	Enter a name for the configuration ID tag using up to 8 ASCII characters. To select a character, press the key that has the desired character. Continue to press the key until the desired character appears. Use the right arrow key to move to the next character. Use the left arrow key to go back to the previous character.
	<div style="border: 1px solid black; padding: 5px;">                     SELECT MODE:                      → ANALOG                      DIGITAL                 </div>	For this example select <i>ANALOG</i> .
	<div style="border: 1px solid black; padding: 5px;">                     MESSAGE:                      ←PREVIOUS      NEXT→                 </div>	Type a descriptive message using up to 32 characters. This field can be used to note anything of importance to the device or installation.  To select a character, press the key that has the desired character. Continue to press the key until the desired character appears. Use the right arrow key to move to the next character. Use the left arrow key to go back to the previous character.
	<div style="border: 1px solid black; padding: 5px;">                     DESCRIPTOR:                      ←PREVIOUS      NEXT→                 </div>	Type a descriptor string using up to 16 characters. This field can be used for notations about the device or process.  To select a character, press the key that has the desired character. Continue to press the key until the desired character appears. Use the right arrow key to move to the next character. Use the left arrow key to go back to the previous character.

Key	Display	Comments
	<div style="border: 1px solid black; padding: 5px;">                     DATE:                      DAY : nn                      MONTH : nn                      YEAR : nnnn                 </div>	Enter a day and press <b>ENTER</b> . Enter a month and press <b>ENTER</b> . Enter a year and press <b>ENTER</b> .  This date can represent the creation date of the configuration, the date the device or element was installed, or some other significant date.
	<div style="border: 1px solid black; padding: 5px;">                     DAMPING:                      (0-100 SEC)                       nn.nn SECS                 </div>	Enter a value between 0 and 100. Refer to the <i>Platinum Standard Series Smart Temperature Transmitter EBTH</i> instruction for description.
	<div style="border: 1px solid black; padding: 5px;">                     ENGINEERING UNIT                      → nnnnnn nnnnnn                      nnnnnn nnnnnn                 </div>	Select engineering units. This appears only for pressure and temperature transmitters.
	<div style="border: 1px solid black; padding: 5px;">                     LOWER RANGE VAL                      nn.nn °C                      UPPER RANGE VAL                      nn.nn °C                 </div>	Enter the lower range temperature value and press <b>ENTER</b> . Input the upper range value.
	<div style="border: 1px solid black; padding: 5px;">                     STORE THIS                      CONFIGURATION                      NO                      → YES                 </div>	Select YES.
		
	<div style="border: 1px solid black; padding: 5px;">                     ID TAGNAME                       READY                 </div>	Configuration ID tag name just configured will be in the upper left corner if the configuration is saved. It becomes the working configuration.

# APPENDIX G - BCN PRESSURE TRANSMITTER

## INTRODUCTION

This appendix covers the configuration and calibration functions of the BCN Pressure Transmitter.

Refer to **OPERATING PROCEDURES** in Section 4 for information on the following functions:

- Send configurations.
- Get configurations.
- View configurations.
- Select configurations.
- Erase configurations.
- Operational functions.

**NOTE:** To change calibration or configuration parameters of a smart field device that is connected to an IMFBS01 module, the device must be taken off-line. This is done at the INFI 90 OPEN console.

## CREATE/MODIFY CONFIGURATION

A configuration can be created off-line, without a connected field device. Figure G-1 provides an overview of the configuration process. The following table details the configuration process.

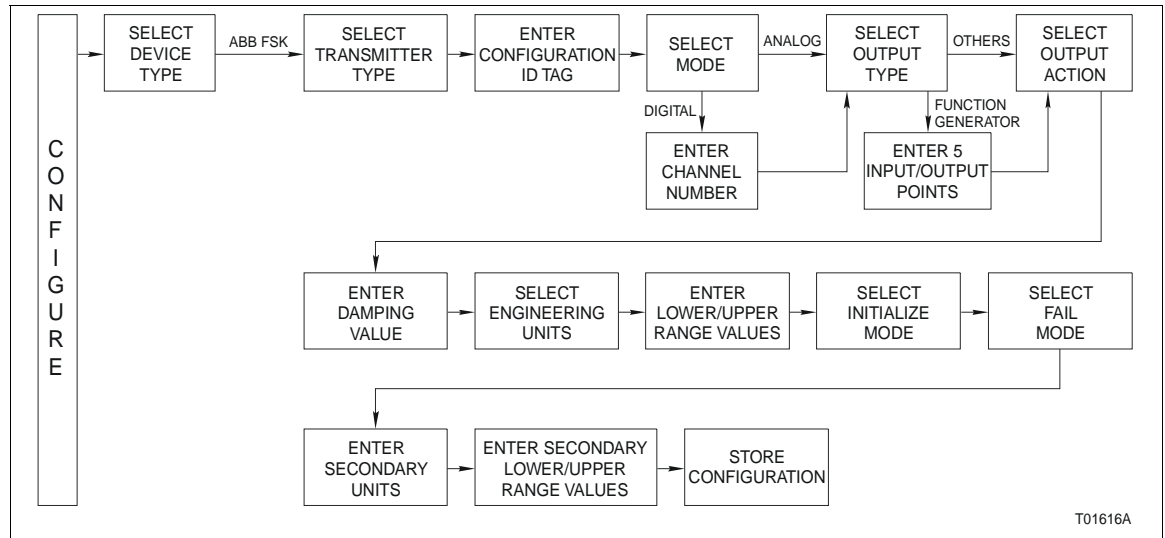









Figure G-1. Configuration Flowchart (BCN)

# BCN PRESSURE TRANSMITTER

Key	Display	Comments
	CONFIGURATION → NEW MODIFY ERASE	Select <i>NEW</i> to create a new configuration. To modify an existing configuration, select <i>MODIFY</i> . The screen sequence is the same, however, the <i>MODIFY</i> screens will appear with the values and cursor positions as originally configured.
	DEVICE TYPE → ABB FSK HART	Select <i>ABB FSK</i> as device type.
 	TRANSMITTER TYPE PTS EQS → BCN EQN AVS TBN480 cond	Use the down arrow key and select <i>BCN</i> .
	STT04 CONFIGURATION [                    ] ←PREVIOUS      NEXT→	Enter a name for the configuration ID tag using up to 14 ASCII characters. To select a character, press the key that has the desired character. Continue to press the key until the desired character appears. Use the right arrow key to move to the next character. Use the left arrow key to go back to the previous character.
 	SELECT MODE: ANALOG → DIGITAL	Select <i>DIGITAL</i> (device in this mode defaults to below 4 mA, independent of input). Use the up and down arrow keys to select mode.  <b>NOTE:</b> The <i>DIGITAL</i> selection should only be made when using an IMFBS01 field bus I/O module. Select <i>ANALOG</i> for all other cases.
	ENTER CHANNEL #: nn	If <i>ANALOG</i> is selected, <i>ENTER CHANNEL #</i> screen will not appear. The next screen will be <i>TRANSMITTER TYPE</i> . This screen is used to assign an address to the transmitter for use with the field bus. The address range is 1 through 8.

Key	Display	Comments
<p>ENTER</p> <p>↓</p> <p>↓</p> <p>↓</p> <p>↓</p>	<p>OUTPUT TYPE 3/2 FLOW MODE 5/2 FLOW MODE → FUNC GEN</p>	<p>For this example, select <i>FUNC GEN</i> as the output type.</p> <p><b>NOTE:</b> The STT04 terminal is capable of displaying 3 output types on the screen. Use the up and down arrow keys to view the additional output types.</p>
<p>ENTER</p>	<p>POINT 1 INP (%) nn.nn POINT 1 OUT (%) nn.nn</p>	<p>Specify five input and output points as a percentage of input. The first and last points on the curve are assumed to be 0.00% and 100.00%. Use the number keys to enter values and press <b>ENTER</b> to advance to the next value. Continue until all 5 pairs of points have been entered.</p>
	<p>POINT 5 INP (%) nn.nn POINT 5 OUT (%) nn.nn</p>	
<p>ENTER</p>	<p>OUTPUT ACTION: → NORMAL REVERSE</p>	<p>Move the indicator to your selection. Refer to the <b>Smart Pressure Transmitter BCN</b> instruction for an explanation of terms.</p>
<p>ENTER</p>	<p>DAMPING: (0 - 32 SEC) _nn.nn SEC</p>	<p>Enter a value between 0 and 32 seconds.</p>
<p>ENTER</p>	<p>ENGINEERING UNIT →iH20 mmHG cmH20 PSI MPA KPA BARS mBARS Kgcm<sup>2</sup></p>	<p>Select an engineering unit.</p>



# BCN PRESSURE TRANSMITTER

Key	Display	Comments
ENTER	LOWER RANGE VAL. nn.nn UNITS UPPER RANGE VAL. nn.nn UNITS	Input lower range value using the number keys and press <b>ENTER</b> . Input the upper range value. The <i>UNITS</i> displayed will be those designated in the previous screen.
ENTER	INITIALIZE MODE: → LOW HIGH	Select <i>LOW</i> using the arrow keys.  Refer to the <b>Smart Pressure Transmitter BCN</b> instruction for mode description.
ENTER	FAIL MODE → LOW HIGH LAST	Select <i>LOW</i> using the arrow keys.
ENTER	ENTER SECONDARY UNITS _nnnnnn	This is a 6 character alphanumeric designation to represent values in user familiar units.  To select a character, press the key that has the desired character. Continue to press the key until the desired character appears. Use the right arrow key to move to the next character. Use the left arrow key to go back to the previous character. Press <b>ENTER</b> when finished.
ENTER	SECONDARY L. R. nn.nn UNITS SECONDARY U. R. nn.nn UNITS	Specify secondary values using the number keys. The <i>UNITS</i> displayed will be those designated in the previous screen. After entering a value press <b>ENTER</b> .
ENTER	STORE THIS CONFIGURATION? NO → YES	Make a selection using the arrow keys.
↓		
ENTER	ID TAGNAME  READY	The Configuration ID tag name just configured will be in the upper left corner if the configuration is saved. It becomes the working configuration.

**CALIBRATION**

There are three types of calibration functions:

- Bench calibration.
- Rezero.
- D-to-A adjust.

**NOTES:**

1. When calibrating, a field device must be connected to the STT04 terminal.
2. To change calibration or configuration parameters of a field device that is connected to an IMFBS01 module, the transmitter must be taken off-line. This is done at the INFI 90 OPEN console.

Refer to Figure G-2 for an overview of the calibration functions.

**NOTE:** When calibrating, a field device must be connected to the STT04 terminal.

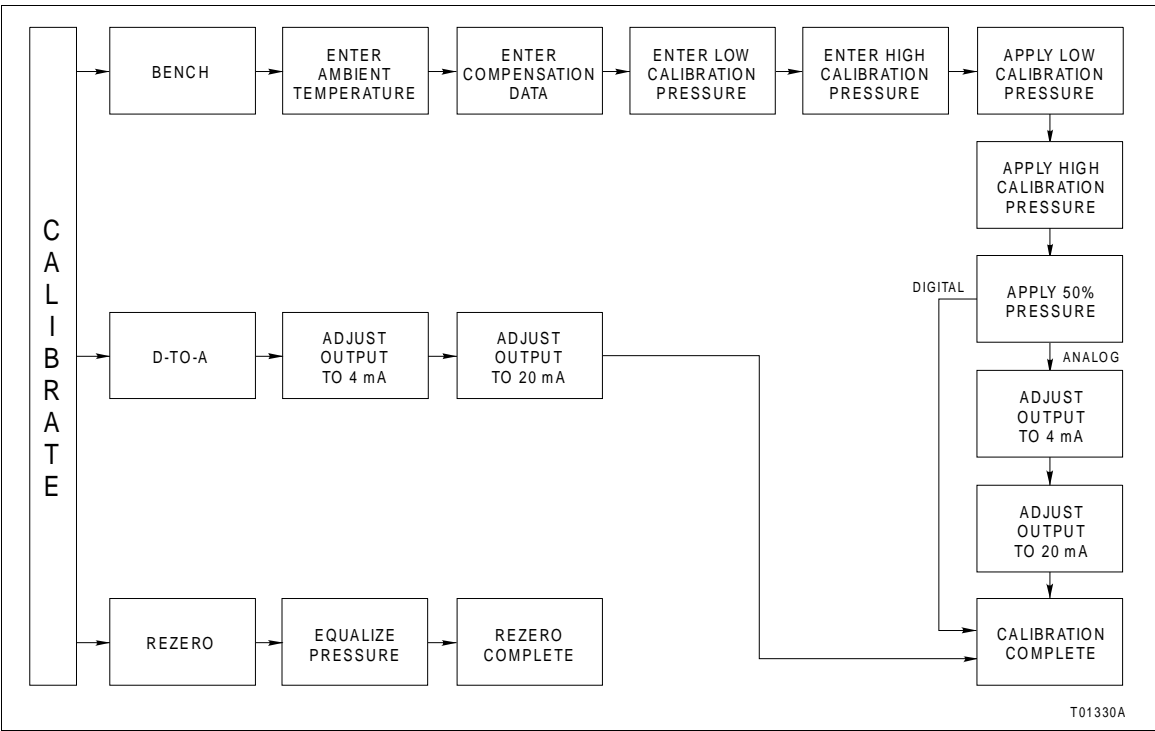

















Figure G-2. Calibration Flowchart (BCN)

**Bench Calibration**

This procedure details the bench calibration process.

# BCN PRESSURE TRANSMITTER







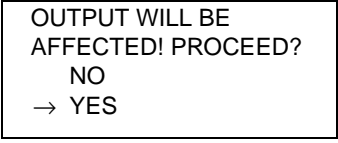

Key	Display	Comments
 	OUTPUT WILL BE AFFECTED! PROCEED? NO → YES	This operation will cause a change in output not corresponding to the input. Be sure the control loop is in manual.  Select <b>YES</b> .
 	CALIBRATION D-TO-A ADJUST → BENCH CALIB. REZERO	Select <b>BENCH CALIB.</b>  If configured digitally, the <i>D-TO-A ADJUST</i> selection will not appear.
	ENTER TRANSMITTER AMBIENT TEMP.  nn C	Enter the field device ambient temperature in degrees Celsius using the number keypad. The surrounding room temperature can be used for this temperature value.
 	ENTER COMP DATA NO → YES	The compensation data is based on characteristics of the individual transducers for temperature correction. Refer to the <b>Smart Pressure Transmitter BCN</b> instruction.
	ZERO SHIFT A. 00000000 B. 00000000 C. 00000000 D. 00000000 E. 00000000	There are 5 sets of data, A through E. Press <b>ENTER</b> to advance to the next set of data. This data should match the tag located in the electronics side of the transmitter. In certain cases, zero shift is entered as a percentage value at -25°C and 85°C.  <b>NOTE:</b> After a value for C is entered D and E are displayed and after E is entered a checksum value is requested.
	SPAN SHIFT A. 00000000 B. 00000000 C. 00000000 D. 00000000 E. 00000000	There are also 5 sets of data, A through E, for span shift. Press <b>ENTER</b> to advance to the next set of data. In certain cases, span shift is entered as a percentage value at -25°C and 85°C.  <b>NOTE:</b> After a value for C is entered D and E are displayed and after E is entered a checksum value is requested.

Key	Display	Comments
	<div style="border: 1px solid black; padding: 5px; text-align: center;">                     LOW CALIB PRESSURE                      nn.nn UNITS                      HIGH CALIB PRESSURE                      nn.nn UNITS                 </div>	Enter the low calibration pressure using the number keypad. Press <b>ENTER</b> . Then enter the high calibration pressure.
	<div style="border: 1px solid black; padding: 5px; text-align: center;">                     APPLY PRESSURE OF                      nn.nn UNITS                      THEN HIT ENTER                 </div>	Apply the low range value to the input of transmitter as specified earlier.
	<div style="border: 1px solid black; padding: 5px; text-align: center;">                     APPLY PRESSURE OF                      nn.nn UNITS                      THEN HIT ENTER                 </div>	Apply the high range value to the input of transmitter as specified earlier.
	<div style="border: 1px solid black; padding: 5px; text-align: center;">                     APPLY PRESSURE OF                      nn.nn UNITS                      THEN HIT ENTER                 </div>	Apply the middle range value. This value is calculated by STT04 terminal using low and high values.
	<div style="border: 1px solid black; padding: 5px; text-align: center;">                     ADJUST TO 4 mA                      THEN HIT ENTER                 </div>	If configured digitally this adjust selection does not appear. Adjust transmitter output using up and down arrow keys.
	<div style="border: 1px solid black; padding: 5px; text-align: center;">                     ADJUST TO 20 mA                      THEN HIT ENTER                 </div>	<p><b>NOTE:</b> When increasing or decreasing the mA signal, the increments of change increase with successive depressions until the maximum level of change is reached. By changing direction the smallest increment of change returns. This technique speeds up the process without affecting fine adjustment.</p> Adjust the transmitter output using up and down arrow keys.
	<div style="border: 1px solid black; padding: 5px; text-align: center;">                     ID TAGNAME                      READY                 </div>	

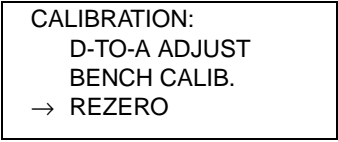
# BCN PRESSURE TRANSMITTER





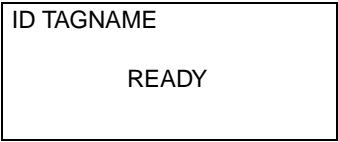

## Rezero

The rezero procedure allows you to zero the transmitter without going through the complete bench calibration procedure.

Key	Display	Comments
		<p>This operation will cause a change in output not corresponding to the input. Be sure the control loop is in manual.</p> <p>Select <i>YES</i>.</p>
		
		<p>Select <i>REZERO</i>.</p> <p>If digitally configured, the <i>D-TO-A ADJUST</i> selection will not appear.</p>
		
		
		<p>Apply zero value to the transmitter.</p>
		<p>Rezero is complete.</p>

**D-to-A Adjust**

The *D-TO-A ADJUST* selection is only present when you are in the *ANA-LOG* communication mode, specified in the configuration procedure. This selection allows you to adjust the four to 20 milliampere output of the field device.

Key	Display	Comments
  	<p>OUTPUT WILL BE AFFECTED! PROCEED? NO → YES</p>	<p>This operation will cause a change in output not corresponding to the input. Be sure the control loop is in manual.  Select YES.</p>
	<p>CALIBRATION → D-TO-A ADJUST BENCH CALIB. REZERO</p>	<p>Select <i>D-TO-A ADJUST</i>.</p>
	<p>ADJUST TO 4 mA  THEN HIT ENTER</p>	<p>Use the arrow keys to adjust the 4 mA signal.  <b>NOTE:</b> When increasing or decreasing the mA signal, the increments of change increase with successive depressions until the maximum level of change is reached. By changing direction you will return to the smallest increment of change. This adjustment technique speeds up the adjustment process without affecting fine adjustment.</p>
	<p>ADJUST TO 20 mA  THEN HIT ENTER</p>	<p>Use the up and down arrow keys to adjust the 20 mA signal.</p>
	<p>ID TAGNAME  READY</p>	

# APPENDIX H - EQN TEMPERATURE TRANSMITTER

## INTRODUCTION

This appendix covers the configuration and calibration functions of the EQN Temperature Transmitter.

Refer to **OPERATING PROCEDURES** in Section 4 for information on the following functions:

- Send configurations.
- Get configurations.
- View configurations.
- Select configurations.
- Erase configurations.
- Operational functions.

**NOTE:** To change calibration or configuration parameters of a smart field device that is connected to an IMFBS01 module, the device must be taken off-line. This is done at the INFI 90 OPEN console.

## CREATE/MODIFY CONFIGURATION

A configuration can be created off-line, without a connected field device. Refer to Figure H-1 for an overview of the configuration function. The following table details the configuration process.

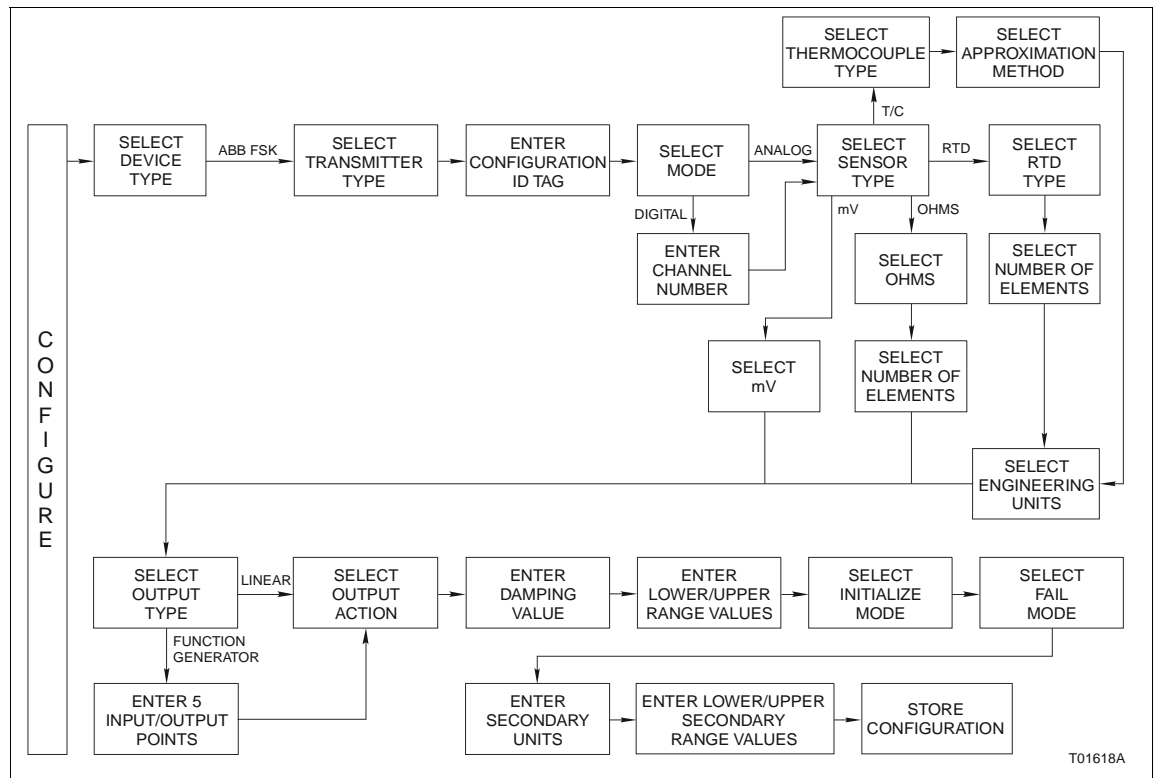











Figure H-1. Configuration Flowchart (EQN)







# EQN TEMPERATURE TRANSMITTER

Key	Display	Comments
	CONFIGURATION → NEW MODIFY ERASE	Select <i>NEW</i> . To create a new configuration. To modify an existing configuration, select <i>MODIFY</i> . The screen sequence is the same, however, the <i>MODIFY</i> screens will appear with the values and cursor positions as originally configured.
	DEVICE TYPE → ABB FSK HART	Select <i>ABB FSK</i> .
  	TRANSMITTER TYPE PTS       EQS BCN      → EQN AVS       TBN cond	Use the arrow keys to select <i>EQN</i> .
	STT04 CONFIGURATION [                    ] ←PREVIOUS      NEXT→	Enter a name for the configuration ID tag using up to 14 ASCII characters. To select a character, press the key that has the desired character. Continue to press the key until the desired character appears. Use the right arrow key to move to the next character. Use the left arrow key to go back to the previous character.
	SELECT MODE: → ANALOG DIGITAL	For this example select <i>ANALOG</i> .
 	SENSOR TYPE: T/C → RTD mV   OHMS	For this example select <i>RTD</i> .



Key	Display	Comments
ENTER	RTD TYPE → 100Ω Pt 385 100Ω Pt 392	Select 100Ω Pt 385 type.
ENTER	NUMBER OF ELEMENTS: → 2-WIRE 3-WIRE DUAL	Select 2-WIRE.
ENTER	ENGINEERING UNITS → °C °F °K	Choose the desired temperature unit.
ENTER	OUTPUT TYPE: → LINEAR FUNC GENERATOR	Select LINEAR. If FUNC GENERATOR is selected, specify 5 input and output points between 0 and 100%.
ENTER	OUTPUT ACTION: → NORMAL REVERSE	Refer to the <b>Smart Electronic Temperature Transmitter EQN</b> instruction for description.
ENTER	DAMPING: (0-32 SEC)  _nn.nn SECS	Enter a value between 0 and 32. Refer to the <b>Smart Electronic Temperature Transmitter EQN</b> instruction for description.
ENTER	LOWER RANGE VAL. nn.nn UNITS UPPER RANGE VAL. nn.nn UNITS	Enter the lower range temperature value and press <b>ENTER</b> . Input the upper range value.
ENTER	INITIALIZE MODE: → LOW HIGH	Refer to the <b>Smart Electronic Temperature Transmitter EQN</b> instruction for description.

## EQN TEMPERATURE TRANSMITTER

Key	Display	Comments
	FAIL MODE: → LOW HIGH LAST	Refer to the <i>Smart Electronic Temperature Transmitter EQN</i> instruction for description.
	ENTER SECONDARY UNITS _nnnnnn	Enter up to 6 characters. Use familiar units to describe the output.  To select a character, press the key that has the desired character. Continue to press the key until the desired character appears. Use the right arrow key to move to the next character. Use the left arrow key to go back to the previous character. Press <b>ENTER</b> when finished.
	SECONDARY L.R. _nn.nn UNITS SECONDARY U.R. nn.nn UNITS	Input the lower range value and press <b>ENTER</b> . Input the upper range value.
	STORE THIS CONFIGURATION NO → YES	
		
	ID TAGNAME  READY	The Configuration ID tag name just configured will be in the upper left corner if the configuration is saved. It becomes the working configuration.

## CALIBRATION

This section details the EQN temperature transmitter calibration functions of the STT04 terminal. There are two types of calibration functions:

- Bench calibration.
- D-to-A adjust.

### NOTES:

1. When calibrating, a field device must be connected to the STT04 terminal.
2. To change calibration or configuration parameters of a field device that is connected to an IMFBS01 module, the transmitter must be taken off-line. This is done at the INFI 90 OPEN console.

Refer to Figure H-2 for an overview of the calibration functions.

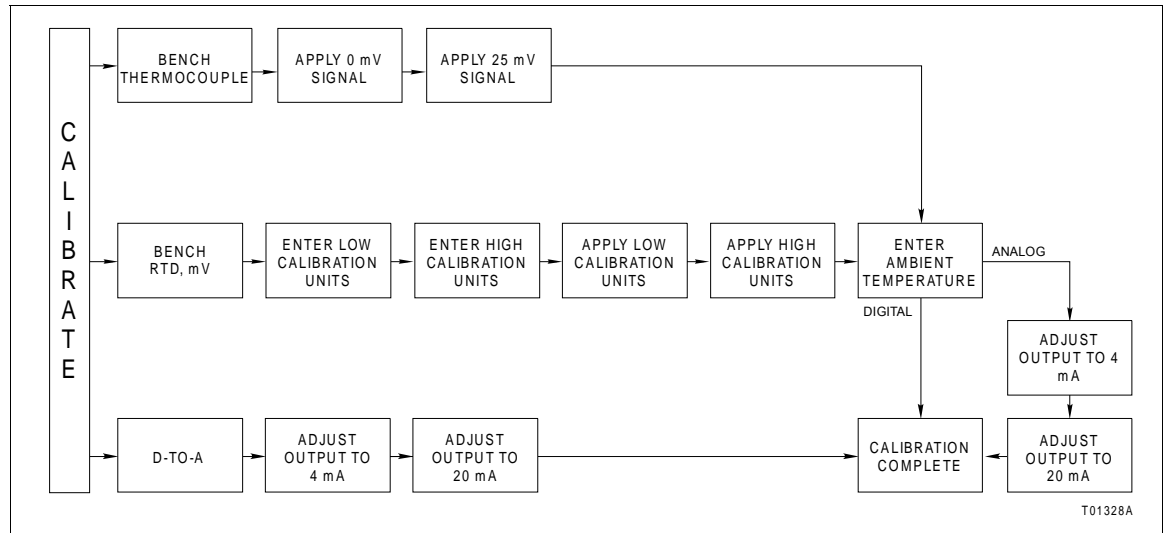

Figure H-2. Calibration Flowchart (EQN)

**Bench Calibration**

This procedure applies to EQN Transmitters configured for either *ANALOG* or *DIGITAL*. Any difference between the two are noted in the **Comments** column.





Key	Display	Comments
CALI-BRATE ↓	OUTPUT WILL BE AFFECTED! PROCEED? NO → YES	This operation will cause a change in output not corresponding to the input. Be sure the control loop is in manual. Select YES.
ENTER ↓	CALIBRATION D-T-O-A ADJUST → BENCH CALIB.	Select <i>BENCH CALIB.</i>

## EQN TEMPERATURE TRANSMITTER

Key	Display	Comments
ENTER	APPLY 0 mV SIGNAL  THEN HIT ENTER	Apply 0 mV to the transmitter.
ENTER	APPLY 25 mV SIGNAL  THEN HIT ENTER	Apply 25 mV to the transmitter.
ENTER	ENTER TRANSMITTER AMBIENT TEMP.  nn.nn C	Enter the field device ambient temperature in degrees Celsius using the number keypad. The surrounding room temperature can be used for this temperature value.
ENTER	ADJUST TO 4 mA  THEN HIT ENTER	Adjust the transmitter output using the up and down arrow keys.
ENTER	ADJUST TO 20 mA  THEN HIT ENTER	Adjust the transmitter output using the up and down arrow keys.
ENTER	ID TAGNAME  READY	Bench calibration is complete.

**D-to-A Adjust**

The *D-TO-A ADJUST* selection is only present when you are in the *ANALOG* communication mode, specified in the configuration procedure. This selection allows you to adjust the four to 20 milliampere output of the field device.

Key	Display	Comments
	<p>OUTPUT WILL BE AFFECTED! PROCEED? NO → YES</p>	<p>This operation will cause a change in output not corresponding to the input. Be sure the control loop is in manual. Select <b>YES</b>.</p>
	<p>CALIBRATION → D-TO-A ADJUST BENCH CALIB.</p>	<p>Select <i>D-TO-A ADJUST</i>.</p>
	<p>ADJUST TO 4 mA  THEN HIT ENTER</p>	<p>Use the arrow keys to adjust the 4 mA signal.  <b>NOTE:</b> When increasing or decreasing the mA signal, the increments of change increase with successive depressions until the maximum level of change is reached. By changing direction you will return to the smallest increment of change. This adjustment technique speeds up the adjustment process without affecting fine adjustment.</p>
	<p>ADJUST TO 20 mA  THEN HIT ENTER</p>	<p>Use the arrow keys to adjust the 20 mA signal.</p>
	<p>ID TAGNAME  READY</p>	

# APPENDIX I - XM/SM/XE MAGNETIC FLOWMETER

## INTRODUCTION

This appendix covers the configuration and calibration functions of the XM/SM/XE Magnetic Flowmeter (Mag Flow).

Refer to **OPERATING PROCEDURES** in Section 4 for information on the following functions:

- Send configurations.
- Get configurations.
- View configurations.
- Select configurations.
- Erase configurations.
- Operational functions.

**NOTE:** To change calibration or configuration parameters of a smart field device that is connected to an IMFBS01 module, the device must be taken off-line. This is done at the INFI 90 OPEN console.

## CREATE/MODIFY CONFIGURATION

A configuration can be created off-line, without a connected field device. Refer to Figure I-1 for an overview of the configuration function. The following table details the configuration process.

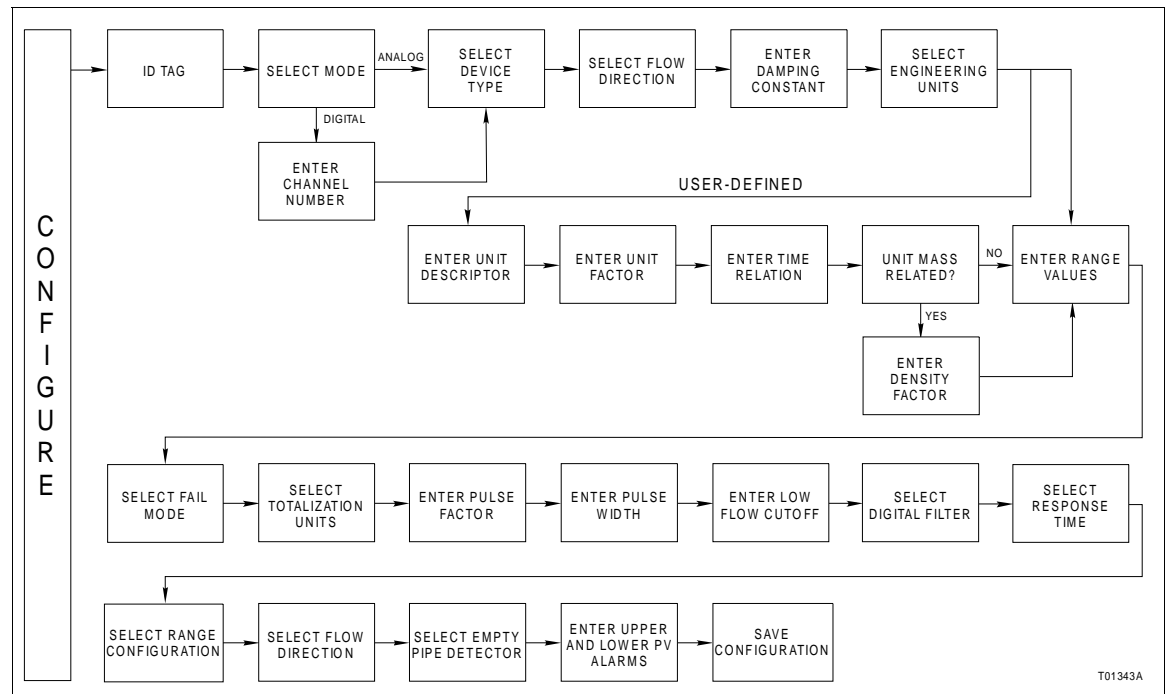









Figure I-1. Configuration Flowchart (XM/SM/XE Mag Flow)









Key	Display	Comments
	<p>DAMPING: (0 - 32 SEC) _nn.nn SEC</p>	<p>Enter a value between 0 and 32 seconds.</p>
	<p>SELECT PV EU → l/s l/m User Defined</p>	<p>Select required engineering units.</p> <p><b>NOTE:</b> If not using <i>User Defined</i> engineering units skip the next five screens to <i>RANGE VALUES</i>.</p>
	<p>EU DESCRIPTOR: nnnn</p>	<p>Enter the description of the user defined engineering units.</p>
	<p>EU FACTOR: nnn.nn EU/l</p>	<p>Enter a range and a scale factor for the user defined engineering unit.</p>
	<p>TIME RELATION → PER SEC PER MIN PER HOUR</p>	<p>Select a time relation for the user defined engineering unit.</p>
	<p>EU MASS RELATED? → NO YES</p>	<p>If the engineering unit is not mass related, skip the next screen.</p>
	<p>DENSITY FACTOR: (0.1 - 5 g/cm<sup>3</sup>) nnn.nn</p>	<p>Enter the density factor for the user defined engineering unit.</p>
	<p>RANGE VAL 1: nnn.nn UNITS RANGE VAL 2: nnn.nn UNITS</p>	<p>Input range value 1 using the number keys, then press <b>ENTER</b>. Input range value 2. The <i>UNITS</i> displayed will be those designated in the previous screens.</p>



# XM/SM/XE MAGNETIC FLOWMETER

Key	Display	Comments
ENTER	RANGE DN: n.nnn UNITS	Enter the calibration factor.
ENTER	FAIL MODE: → LOW HIGH	Make a selection using the arrow keys.
ENTER	SELECT TOT. EU: → l m3 User Defined	Select the engineering units for the totalizer.
ENTER	PULSE FACTOR: (0.001 - 1000/EU) nnn.nn	Enter the proper pulse factor for the totalization process.
ENTER	PULSE WIDTH: (0.64 - 2000 ms) nnn.nn	Enter a value between 0.032 and 2000 ms. For driving an electromechanical counter, the pulse width should be about 50 ms. For high speed electronic devices a pulse width of 0.05 ms. is common.
ENTER	LOW FLOW CUTOFF: (0 - 10%) nn.nn%	Enter a value between 0 and 10% of full scale. This parameter causes the input to drop to a zero state when the flow drops below the set value.
ENTER	DIGITAL FILTER: → OFF ON	Make a selection using the arrow keys.
ENTER	RANGE CONFIG: → 2-FWD 1-FWD, 1-REV	Make a selection using the arrow keys.

Key	Display	Comments
	<div style="border: 1px solid black; padding: 5px;">                     FLOW DIRECTION:                      → FWD AND REV                      FWD ONLY                 </div>	Make a selection using the arrow keys.
	<div style="border: 1px solid black; padding: 5px;">                     EMPTY PIPE DET.:                      → OFF                      ON                 </div>	Make a selection using the arrow keys.
	<div style="border: 1px solid black; padding: 5px;">                     UPPER PV ALARM                      nnn.nn UNITS                      LOWER PV ALARM                      nnn.nn UNITS                 </div>	Specify values using the number keys. The <i>UNITS</i> displayed will be those designated in a previous screen. After entering a value press <b>ENTER</b> .
	<div style="border: 1px solid black; padding: 5px;">                     STORE THIS                      CONFIGURATION?                      NO                      → YES                 </div>	Make a selection using the arrow keys.
		
	<div style="border: 1px solid black; padding: 5px;">                     ID TAGNAME                       READY                 </div>	

**CALIBRATION**

This section details the calibration functions of the STT04 terminal while interfacing an XM/SM/XE Mag Flow Meter. There are two types of calibration functions:

- Empty pipe detector.
- D-to-A adjust.

**NOTES:**

1. When calibrating, a field device must be connected to the STT04 terminal.
2. To change calibration or configuration parameters of a field device that is connected to an IMFBS01 module, the transmitter must be taken off-line. This is done at the INFI 90 OPEN console.

Refer to Figure I-2 for an overview of the calibration functions.

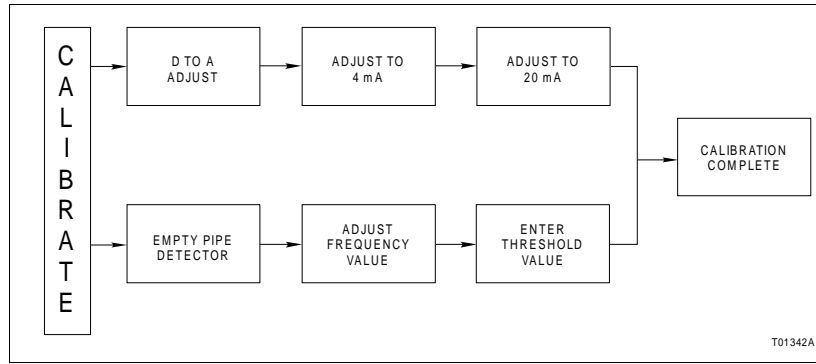



Figure I-2. Calibration Flowchart (XM/SM/XE Mag Flow)

**Empty Pipe Detector**







This procedure applies to XM/SM/XE Mag Flow meters configured for either *ANALOG* or *DIGITAL*. Any difference between the two are noted in the **Comments** column.

Key	Display	Comments
CALI-BRATE ↓	OUTPUT WILL BE AFFECTED! PROCEED? NO → YES	This operation will cause a change in output not corresponding to the input. Be sure the control loop is in manual. Select YES.
ENTER ↓	CALIBRATION D-TO-A ADJUST → EMPTY PIPE DET	Select <i>EMPTY PIPE DET</i> . If configured digitally, the <i>D-TO-A ADJUST</i> selection will not appear.
ENTER	FREQUENCY nnn.nn	Use the arrow keys to adjust the frequency as described in the Mag-Flow product instruction. The frequency value will be updated between key presses, during which, a wait screen will appear.
ENTER	THRESHOLD: nnn.nn Hz	Enter the threshold of the empty pipe detector with the number keys.

Key	Display	Comments
	<div style="border: 1px solid black; padding: 5px; text-align: center;">                     ID TAGNAME                       READY                 </div>	Empty pipe detector calibration is complete.

***D-to-A Adjust***

The *D-TO-A ADJUST* selection is only present when you are in the *ANALOG* communication mode, specified in the configuration procedure. This selection allows you to adjust the four to 20 milliampere output of the field device.

Key	Display	Comments
	<div style="border: 1px solid black; padding: 5px; text-align: center;">                     OUTPUT WILL BE                      AFFECTED! PROCEED?                      NO                      → YES                 </div>	This operation will cause a change in output not corresponding to the input. Be sure the control loop is in manual.  Select <b>YES</b> .
		
	<div style="border: 1px solid black; padding: 5px; text-align: center;">                     CALIBRATION                      → D-TO-A ADJUST                      EMPTY PIPE DET                 </div>	Select <i>D-TO-A ADJUST</i> .
	<div style="border: 1px solid black; padding: 5px; text-align: center;">                     ADJUST TO 4 mA                       THEN HIT ENTER                 </div>	Use the arrow keys to adjust the 4 mA signal.  <b>NOTE:</b> When increasing or decreasing the mA signal, the increments of change increase with successive depressions until the maximum level of change is reached. By changing direction you will return to the smallest increment of change. This adjustment technique speeds up the adjustment process without affecting fine adjustment.
	<div style="border: 1px solid black; padding: 5px; text-align: center;">                     ADJUST TO 20 mA                       THEN HIT ENTER                 </div>	Use the arrow keys to adjust the 20 mA signal.
	<div style="border: 1px solid black; padding: 5px; text-align: center;">                     ID TAGNAME                       READY                 </div>	

# APPENDIX J - TBN480 CONDUCTIVITY TRANSMITTER

## INTRODUCTION

This appendix covers the configuration and calibration functions of the TBN480 Conductivity Transmitter.

Refer to **OPERATING PROCEDURES** in Section 4 for information on the following functions:

- Send configurations.
- Get configurations.
- View configurations.
- Select configurations.
- Erase configurations.
- Operational functions.

**NOTE:** To change calibration or configuration parameters of a smart field device that is connected to an IMFBS01 module, the device must be taken off-line. This is done at the INFI 90 OPEN console.

## CREATE/MODIFY CONFIGURATION

A configuration can be created off-line, without a connected field device. Refer to Figure J-1 for an overview of the configuration function. The following table details the configuration process.

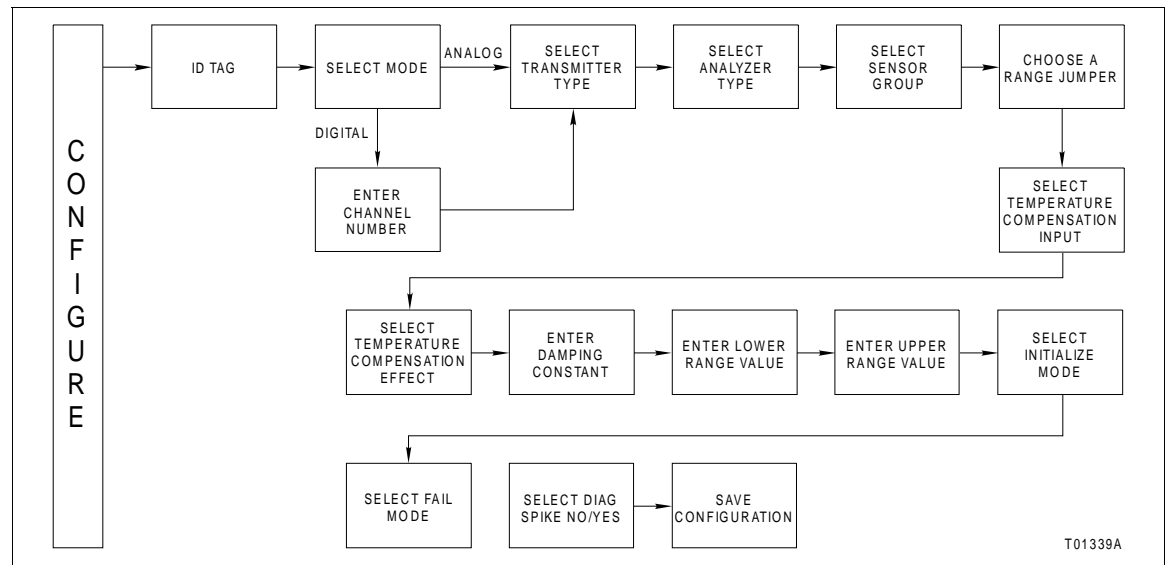



















Figure J-1. Configuration Flowchart (TBN480)

**TBN480 CONDUCTIVITY TRANSMITTER**

Key	Display	Comments
	CONFIGURATION → NEW MODIFY ERASE	Select <i>NEW</i> to create a new configuration. To modify an existing configuration, select <i>MODIFY</i> . The screen sequence is the same, however, the <i>MODIFY</i> screens will appear with the values and cursor positions as originally configured.
	DEVICE TYPE → ABB FSK HART	Select <i>ABB FSK</i> .
	TRANSMITTER TYPE PTS EQS BCN EQN AVS → TB480 cond	Use the down arrow key to select <i>TBN480 cond</i> .
		
		
		
	STT04 CONFIGURATION [                    ] ←PREVIOUS    NEXT→	Enter a name for the configuration ID tag using up to 14 ASCII characters. To select a character, press the key that has the desired character. Continue to press the key until the desired character appears. Use the right arrow key to move to the next character. Use the left arrow key to go back to the previous character.
	SELECT MODE: → ANALOG DIGITAL	Select <i>ANALOG</i> .
	ANALYZER TYPE → GENERAL PURE H2O COND CONCENTRATION	Select analyzer type.

Key	Display	Comments
	<div style="border: 1px solid black; padding: 5px;">                     SENSOR GROUP                      → A                      B                      C                 </div>	Refer to <b>Smart Conductivity Transmitter Series TBN480</b> instruction for description.
  	<div style="border: 1px solid black; padding: 5px;">                     RANGE JUMPER                      HIGH                      MEDIUM                      → LOW                 </div>	Refer to <b>Smart Conductivity Transmitter Series TBN480</b> instruction for description.
	<div style="border: 1px solid black; padding: 5px;">                     ANALYZER RANGE                      0-9990 <math>\mu</math>S/cm                      0-999 <math>\mu</math>S/cm                 </div>	Displays analyzer ranges.
 	<div style="border: 1px solid black; padding: 5px;">                     TEMP COMP                      INPUT                      → MANUAL                      3.0K<math>\Omega</math> BALCO                 </div>	Select proper temperature compensation input. Refer to <b>Smart Conductivity Transmitter Series TBN480</b> instruction for description.
	<div style="border: 1px solid black; padding: 5px;">                     TEMP COMP TYPE                      → STANDARD                      0-15% NaOH                      0-20% NaCl                 </div>	Select a temperature compensation effect. Use the down arrow key to view more selections. Refer to <b>Smart Conductivity Transmitter Series TBN480</b> instruction for description.
	<div style="border: 1px solid black; padding: 5px;">                     DAMPING:                      (0-32 SEC)                       _nn.nn                 </div>	Enter a value between 0 and 32. Refer to the <b>Smart Conductivity Transmitter Series TBN480</b> instruction for description.

# TBN480 CONDUCTIVITY TRANSMITTER

Key	Display	Comments
ENTER	LOWER RANGE VAL. nnn.nn $\mu$ S/cm UPPER RANGE VAL. nnn.nn $\mu$ S/cm	Enter the lower range temperature value and press <b>ENTER</b> . Input the upper range value. Low and high default values are dependent on the sensor group and range jumper setting. Refer to the <b>Smart Conductivity Transmitter Series TBN480</b> instruction for description.
ENTER	INITIALIZE MODE: LOW → HIGH	On power up, a two second initialization period occurs during which the transmitter output becomes either 100% (high) or 0% (low).
ENTER	FAIL MODE: LOW → HIGH LAST	During continual diagnostics, if the microcomputer detects a fatal problem the transmitter output will go to 0% (low), 100% (high), or the last value before the error.
ENTER	DIAG SPIKE OUTPUT → NO YES	In analog mode, a pulse can be sent on the 4 to 20 mA output to indicate a detected sensor fault. This pulse can be adjusted from 0 to 100% of the loop current (0 to 16 mA).
ENTER	STORE THIS CONFIGURATION NO → YES	Select YES to store the configuration.
↓	ID TAGNAME  READY	



**CALIBRATION**

This section details the TBN480 conductivity transmitter calibration functions using the STT04 terminal. There are three types of calibration functions:

- Process.
- Edit.
- Reset.

**NOTES:**

1. When calibrating, a field device must be connected to the STT04 terminal.
2. To change calibration or configuration parameters of a field device that is connected to an IMFBS01 module, the transmitter must be taken off-line. This is done at the INFI 90 OPEN console.

Refer to Figure J-1 for an overview of the calibration functions

**Process Calibration**

This procedure applies to TBN480 Transmitters configured for either *ANALOG* or *DIGITAL*. Any differences between the two are noted in the **Comments** column.

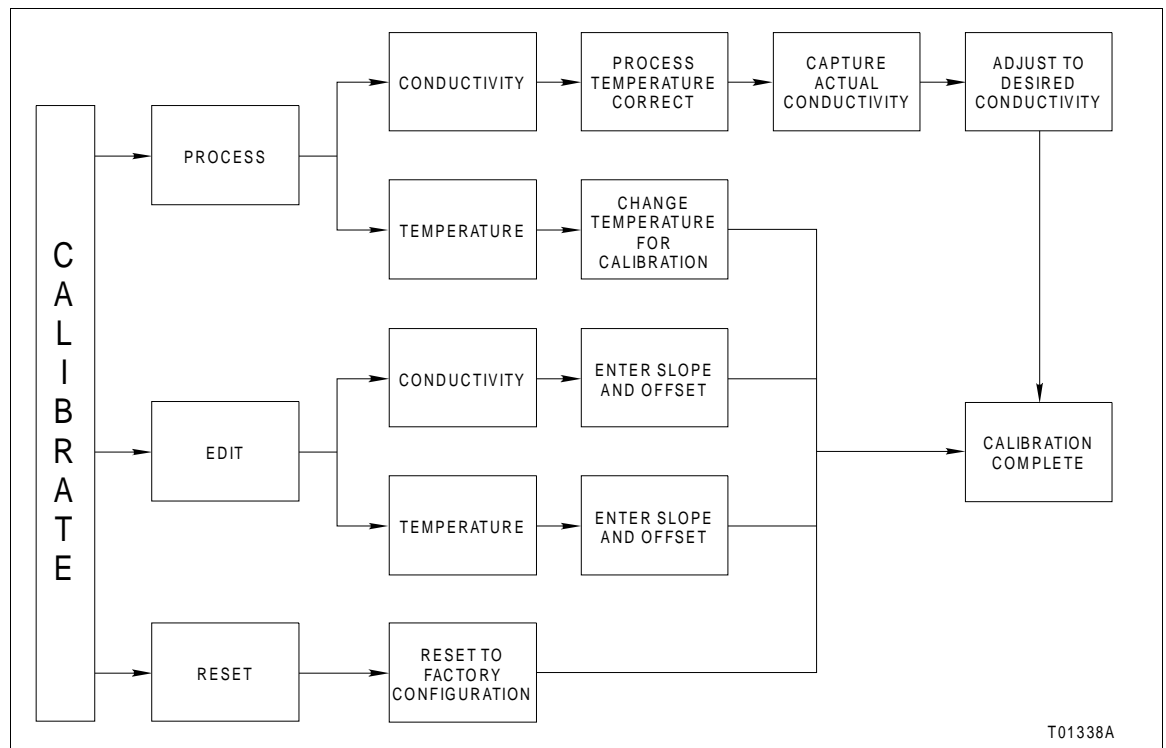











Figure J-2. Calibration Flowchart (TBN480)

**CALIBRATE PROCESS CONDUCTIVITY**





The following procedure steps through the calibration of the process conductivity.

Key	Display	Comments
 	<p>OUTPUT WILL BE AFFECTED! PROCEED? NO → YES</p>	<p>This operation will cause a change in output not corresponding to the input. Be sure the control loop is in manual. Select <b>YES</b>.</p>
	<p>CALIBRATION → PROCESS CAL EDIT CAL RESET CAL</p>	<p>Select <b>PROCESS CAL</b>.</p>
	<p>PROCESS CAL → CONDUCTIVITY TEMPERATURE</p>	<p>Select <b>CONDUCTIVITY</b>.</p>
	<p>PROCESS TEMP nn.nn CAL TEMP 1st IF INCORRECT</p>	<p>If the temperature value is not correct, go back and calibrate the process temperature before proceeding. Refer to <b>Process Calibration</b> in this section.</p>
	<p>PROCESS CAL nn.nn mS/cm PRESS ENTER TO CONTINUE</p>	<p>This displays the actual live reading. When the reading is stable press <b>ENTER</b>. The value displayed is captured for the next process calibration screen.</p>
	<p>PROCESS CAL ENTER DESIRED CONDUCTIVITY nn.nn mS/cm</p>	<p>Use the numeric keys to correct the captured value to the desired value.</p>
	<p>WORKING</p>	



Key	Display	Comments
	<div data-bbox="597 258 932 394" style="border: 1px solid black; padding: 5px; text-align: center;">                     CALIBRATION COMPLETE                 </div> <div data-bbox="597 457 932 594" style="border: 1px solid black; padding: 5px; text-align: center;">                     ID TAGNAME  READY                 </div>	Calibration complete.

**CALIBRATE PROCESS TEMPERATURE**

This section steps through calibrating the process temperature.

Key	Display	Comments
 	<div data-bbox="597 863 932 999" style="border: 1px solid black; padding: 5px;">                     OUTPUT WILL BE AFFECTED! PROCEED? NO → YES                 </div>	This operation will cause a change in output not corresponding to the input. Be sure the control loop is in manual.  Select <i>YES</i> .
	<div data-bbox="597 1157 932 1293" style="border: 1px solid black; padding: 5px;">                     CALIBRATION → PROCESS CAL EDIT CAL RESET CAL                 </div>	Select <i>PROCESS CAL</i> .
 	<div data-bbox="597 1354 932 1491" style="border: 1px solid black; padding: 5px;">                     PROCESS CAL  CONDUCTIVITY → TEMPERATURE                 </div>	Select <i>TEMPERATURE</i> .

# TBN480 CONDUCTIVITY TRANSMITTER



Key	Display	Comments
	CHANGE TEMP FOR CALIBRATION nn.nn °C	Use the numeric keys to enter the process temperature.
	WORKING	
	CALIBRATION COMPLETE	
	ID TAGNAME READY	

## Editing the Calibration Constants

These functions are for recording or modifying slope or offset calibration constants.

## EDIT CONDUCTIVITY

This procedure steps through the modification of the conductivity.









Key	Display	Comments
 	OUTPUT WILL BE AFFECTED! PROCEED? NO → YES	This operation will cause a change in output not corresponding to the input. Be sure the control loop is in manual. Select YES.

Key	Display	Comments
<p>ENTER</p> <p>↓</p>	<p>CALIBRATION PROCESS CAL → EDIT CAL RESET CAL</p>	<p>Select <i>EDIT CAL</i>.</p>
<p>ENTER</p>	<p>EDIT CAL DATA → CONDUCTIVITY TEMPERATURE</p>	<p>Select <i>CONDUCTIVITY</i>.</p>
<p>ENTER</p>	<p>CONDUCTIVITY PROCESS CAL SLP: n.nnnn OFF: n.nnnn</p>	<p>To view values press <b>ENTER</b> twice. To change the slope enter the correct number and press <b>ENTER</b>. To change the offset, enter the correct number and press <b>ENTER</b>.</p>
<p>ENTER</p>	<p>WORKING</p>	
	<p>CALIBRATION COMPLETE</p>	
<p>ENTER</p>	<p>ID TAGNAME READY</p>	

**EDIT TEMPERATURE**







This procedure steps through modification of the temperature.

# TBN480 CONDUCTIVITY TRANSMITTER

Key	Display	Comments
 	<p>OUTPUT WILL BE AFFECTED! PROCEED? NO → YES</p>	<p>This operation will cause a change in output not corresponding to the input. Be sure the control loop is in manual. Select <b>YES</b>.</p>
 	<p>CALIBRATION PROCESS CAL → EDIT CAL RESET CAL</p>	<p>Select <b>EDIT CAL</b>.</p>
 	<p>EDIT CAL DATA CONDUCTIVITY → TEMPERATURE</p>	<p>Select <b>TEMPERATURE</b>.</p>
	<p>TEMPERATURE PROCESS CAL SLP: n.nnnn OFF: n.nnnn</p>	<p>To view values, press <b>ENTER</b> twice. To change the slope, enter the correct number and press <b>ENTER</b>. To change the offset, enter the correct number and press <b>ENTER</b>.</p>
	<p>WORKING</p>	
	<p>CALIBRATION COMPLETE</p>	
	<p>ID TAGNAME READY</p>	<p>Calibration complete.</p>

**Reset to Factory Configuration**

This function resets all of the device parameters to the factory settings. Refer to the product instruction for information on the factory settings.

Key	Display	Comments
 	<div data-bbox="597 457 932 596" style="border: 1px solid black; padding: 5px;">                     OUTPUT WILL BE                      AFFECTED! PROCEED?                      NO                      → YES                 </div>	This operation will cause a change in output not corresponding to the input. Be sure the control loop is in manual.  Select YES.
  	<div data-bbox="597 737 932 875" style="border: 1px solid black; padding: 5px;">                     CALIBRATION                      PROCESS CAL                      EDIT CAL                      → RESET CAL                 </div>	Select RESET CAL.
	<div data-bbox="597 1142 932 1276" style="border: 1px solid black; padding: 5px; text-align: center;">                     WORKING                 </div>	
	<div data-bbox="597 1339 932 1474" style="border: 1px solid black; padding: 5px; text-align: center;">                     CALIBRATION                      COMPLETE                 </div>	
	<div data-bbox="597 1539 932 1673" style="border: 1px solid black; padding: 5px;">                     ID TAGNAME                       READY                 </div>	

# APPENDIX K - TBN580 TRANSMITTER

## INTRODUCTION

This appendix covers the configuration and calibration functions of the TBN580 Transmitter. Refer to **OPERATING PROCEDURES** in Section 4 for information on the following functions:

- Send configurations.
- Get configurations.
- View configurations.
- Select configurations.
- Erase configurations.
- Operational functions.

**NOTE:** To change calibration or configuration parameters of a smart field device that is connected to an IMFBS01 module, the device must be taken off-line. This is done at the INFI 90 OPEN console.

## CREATE/MODIFY CONFIGURATION

A configuration can be created off-line, without a connected field device. Refer to Figure K-1 for an overview of the configuration function of the TBN580 pH transmitter. The following table details the configuration process.

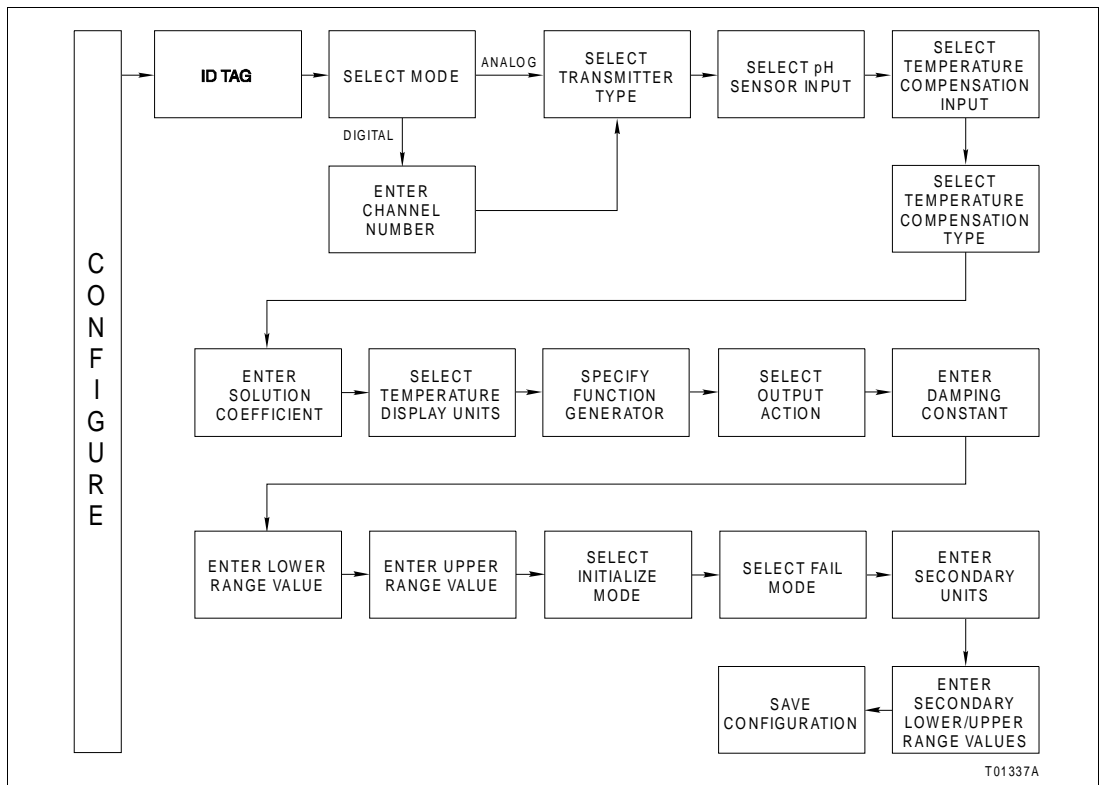











Figure K-1. Configuration Flowchart (TBN580)





Key	Display	Comments
	TEMP COMP INPUT → 3.01 K BALCO NONE	Select 3.01 K BALCO.  When NONE is selected, the STT04 terminal branches to a <i>TEMPERATURE DISPLAY UNITS</i> selection screen. Choose the desired temperature unit.
  	TEMP COMP TYPE MANUAL AUTO NERNSTIAN → AUTO SOLUTION AUTO PURE H2O	For this example select <i>AUTO SOLUTION</i> .  <b>NOTE:</b> Other temperature compensation selections branch to a <i>TEMPERATURE DISPLAY UNITS</i> selection screen.
	ENTER SOLUTION CO-EFFICIENT ±n.nnn pH per 10°C (from 25°C)	This screen is unique to the <i>AUTO SOLUTION</i> selection of the <i>TEMP COMP TYPE</i> . Other selections go to the temperature display units.
	TEMPERATURE DISPLAY UNITS → °C °F	
	OUTPUT FUNC GEN → NO YES	Select NO.  If YES is selected, enter 5 input and output points. Values must be between 0 and 100%.
	OUTPUT ACTION: → NORMAL REVERSE	Refer to the <b>Smart Specific Ion Transmitter Series TBN580</b> instruction for description.
	DAMPING: (0-32 SEC)  _nn.nn	Enter a value between 0 and 32. Refer to the <b>Smart Specific Ion Transmitter Series TBN580</b> instruction for description.

# TBN580 TRANSMITTER

Key	Display	Comments
ENTER	LOWER RANGE VAL. _nn.nn pH UPPER RANGE VAL. nn.nn pH	Enter the lower range value and press <b>ENTER</b> . Input the upper range value.
ENTER	INITIALIZE MODE: → LOW HIGH	Refer to the <b>Smart Specific Ion Transmitter Series TBN580</b> instruction for description.
ENTER	FAIL MODE: → LOW HIGH LAST	During continual diagnostics, if the microcomputer detects a fatal problem the transmitter output will go to 0% (low), 100% (high), or the last value before the error.
ENTER	ENTER SECONDARY UNITS _nnnnnn	Enter up to 6 characters. Use familiar units to describe the output.
ENTER	SECONDARY L.R. _nn.nn UNITS SECONDARY U.R. nn.nn UNITS	Input the lower range value and press <b>ENTER</b> . Input the upper range value.
ENTER	STORE THIS CONFIGURATION NO → YES	To store the configuration, select YES.
↓		
ENTER	ID TAGNAME  READY	

**CALIBRATION**

This section details the calibration functions of the STT04 terminal while interfacing a TBN transmitter. There are three types of calibration functions:

- Process calibration.
- Bench calibration (pH and temperature).
- D-to-A adjust.

**NOTES:**

1. When calibrating, a field device must be connected to the STT04 terminal.
2. To change calibration or configuration parameters of a field device that is connected to an IMFBS01 module, the transmitter must be taken off-line. This is done at the INFI 90 OPEN console.

Refer to Figure K-2 for an overview of the calibration functions.

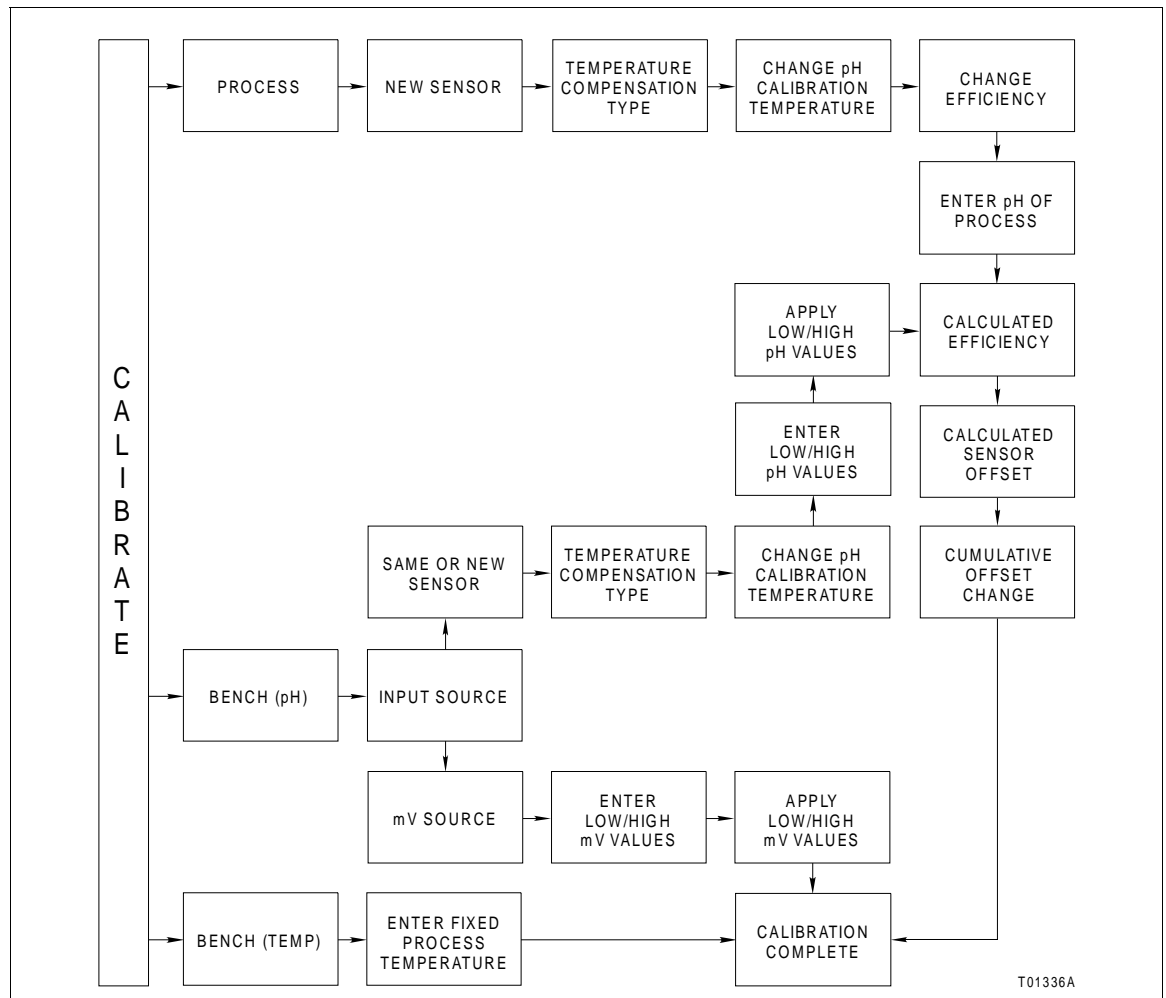









Figure K-2. Calibration Flowchart (TBN580)

**Process Calibration**

This procedure applies to TBN transmitters configured for either *ANA-LOG* or *DIGITAL*. Any differences between the two are noted in the **Comments** column.











Key	Display	Comments
 	<p>OUTPUT WILL BE AFFECTED! PROCEED? NO → YES</p>	<p>Select <i>YES</i>.</p>
	<p>CALIBRATION → PROCESS CAL BENCH CAL pH BENCH CAL TEMP D-TO-A ADJUST</p>	<p>Select <i>PROCESS CAL</i>. If configured digitally, the <i>D-TO-A ADJUST</i> selection would not appear.</p>
	<p>INSTALLING A NEW SENSOR? → NO YES</p>	<p>Select <i>NO</i>. If <i>YES</i>, a new sensor offset will be calculated and the cumulative offset change will be reset to 0.00 mV.</p>
	<p>TEMP COMP TYPE IN USE:  HIT ENTER</p>	<p>Displayed will be the <i>TEMP COMP TYPE</i> selected in configuration.</p>
	<p>ENTER FIXED PROCESS TEMP nnn.n°UNITS</p>	<p>If <i>TEMP COMP TYPE</i> is <i>MANUAL</i> or <i>NONE</i> (as selected in configuration), this screen will appear, otherwise, the next screen, <i>CHANGE TEMP OF PROCESS?</i> will appear. Default is 25°C.</p>
	<p>CHANGE TEMP OF PROCESS? nnn°UNITS</p>	<p>The value displayed is the temperature of the process (interior of sensor).  <b>NOTE:</b> If the new temperature value is entered, this change will affect the calibration of temperature.</p>

Key	Display	Comments
ENTER	CHANGE EFFICIENCY? nn.nn% HIT ENTER	Value from last calibration. If <i>NEW SENSOR</i> , efficiency will be 98%. This value can be changed if desired. A change in efficiency will affect the calibration span.
ENTER	CURRENT READING nn.nn pH ENTER DESIRED nn.nn pH	The current PH value is displayed. Enter the desired PH value.
ENTER	CALCULATED EFFICIENCY nnn.nn% HIT ENTER	
ENTER	CALCULATED SENSOR OFFSET nnn.nn pH HIT ENTER	This value is recalculated during each calibration.
ENTER	CUMULATIVE OFFSET CHANGE n.nn pH HIT ENTER	This value shows the offset change over time for a particular sensor. Value resets to 0.00 pH if installing a new sensor.
ENTER	ID TAGNAME  READY	

**Bench Calibration pH**

The following procedure steps through the bench calibration of the pH level.

# TBN580 TRANSMITTER









Key	Display	Comments
 	<p>OUTPUT WILL BE AFFECTED! PROCEED? NO → YES</p>	<p>This operation will cause a change in output not corresponding to the input. Be sure the control loop is in manual. Select <b>YES</b>.</p>
 	<p>CALIBRATION PROCESS CAL → BENCH CAL pH BENCH CAL TEMP</p>	<p>Select <b>BENCH CAL pH</b>.</p>
  	<p>INPUT SOURCE: SAME SENSOR NEW SENSOR → mV SOURCE</p>	<p>Select <b>mV SOURCE</b>. When selecting <b>SAME SENSOR</b> or <b>NEW SENSOR</b>, the smart terminal branches to <b>TEMP COMP TYPE IN USE</b>.</p>
	<p>ENTER LO mV CAL nn.nn mV ENTER HI mV CAL nn.nn mV</p>	<p>The following mV screens apply only when <b>mV SOURCE</b> is selected under <b>INPUT SOURCE</b>. <b>NOTE:</b> Positive mV corresponds to low pH values and negative mV corresponds to high pH values.  Default values are <math>\pm 414</math> mV.</p>
	<p>APPLY nn.nn mV nn.nn HIT ENTER WHEN STABLE</p>	<p>Positive mV cal value specified on the prior screen will be displayed. Apply low mV value. When applied, the value shown on the smart terminal (from the input source) will not match the specified value. Press <b>ENTER</b> when the applied value stabilizes.</p>
	<p>APPLY nn.nn mV nn.nn HIT ENTER WHEN STABLE</p>	<p>Negative mV cal value specified on the prior screen will be displayed. Apply high mV value. When applied, the value shown on the smart terminal (from the input source) will not match the specified value. Press <b>ENTER</b> when the applied value stabilizes. When mV operation is complete press <b>ENTER</b>, the <b>READY</b> screen will follow.</p>

Key	Display	Comments
ENTER	CHANGE pH CAL TEMPERATURE? nnn°UNITS	The value displayed is the temperature of the process (interior of sensor). Default is 25°C.  <b>NOTE:</b> If a new temperature value is entered, it is used only for pH calibration. This change does not affect the calibration on the temperature sensor.
ENTER	ENTER LO pH CAL nn.nn pH ENTER HI pH CAL nn.nn pH	Default values 4.01 and 7.00 pH. Enter low pH value and press <b>ENTER</b> . Enter the high pH value. If <i>mV SOURCE</i> , default is 0.00 and 14.00 pH at 25°C.
ENTER	APPLY nn.nn pH nn.nn pH HIT ENTER WHEN STABLE	Displays low pH calibration value, and the uncalibrated pH value as determined from the input source.
ENTER	APPLY nn.nn pH nn.nn pH HIT ENTER WHEN STABLE	Displays high pH calibration value, and the uncalibrated pH value as determined from the input source.
ENTER	CALCULATED EFFICIENCY nnn.n % HIT ENTER	Value from the last calibration. If <i>NEW SENSOR</i> efficiency will be 98%.
ENTER	CALCULATED SENSOR OFFSET nnn pH HIT ENTER	This value is recalculated during each calibration.
ENTER	CUMULATIVE OFFSET CHANGE nnn pH HIT ENTER	This value shows the offset change over time for a particular sensor. Value resets to 0.00 pH if installing a new sensor.
ENTER	ID TAGNAME  READY	











**Bench Calibration Temperature**

The following procedure steps through the bench calibration of the temperature.

Key	Display	Comments
 	<p>OUTPUT WILL BE AFFECTED! PROCEED? NO → YES</p>	<p>This operation will cause a change in output not corresponding to the input. Be sure the control loop is in manual. Select <b>YES</b>.</p>
  	<p>CALIBRATION PROCESS CAL BENCH CAL pH → BENCH CAL TEMP</p>	<p>Select <b>BENCH CAL TEMP</b>.</p>
	<p>ENTER FIXED PROCESS TEMP nnn.n° UNITS</p>	<p>If in <b>TEMP COMP TYPE</b>, <b>MANUAL</b> or <b>NONE</b> is selected during configuration, this screen will not appear, otherwise the next screen, <b>CHANGE TEMP OF PROCESS?</b> appears. Default is 25°C.</p>
	<p>CHANGE TEMP OF PROCESS? nnn.n° UNITS</p>	<p>The value displayed is the temperature of the process (interior of sensor). <b>NOTE:</b> If a new temperature value is entered, this change will affect the calibration of temperature.</p>
	<p>ID TAGNAME  READY</p>	

**D-to-A Adjust**

The *D-TO-A ADJUST* selection is only present when you are in the *ANALOG* communication mode, specified in the configuration procedure. This selection allows you to adjust the four to 20 milliampere output of the field device.

Key	Display	Comments
 	<div data-bbox="597 491 932 632" style="border: 1px solid black; padding: 5px;">                     OUTPUT WILL BE                      AFFECTED! PROCEED?                      NO                      → YES                 </div>	This operation will cause a change in output not corresponding to the input. Be sure the control loop is in manual.  Select <b>YES</b> .
   	<div data-bbox="597 779 932 940" style="border: 1px solid black; padding: 5px;">                     CALIBRATION                      PROCESS CAL                      BENCH CAL pH                      BENCH CAL TEMP                      → D-TO-A ADJUST                 </div>	Select <i>D-TO-A ADJUST</i> .
	<div data-bbox="597 1304 932 1436" style="border: 1px solid black; padding: 5px;">                     ADJUST TO 4 mA                       THEN HIT ENTER                 </div>	Use the arrow keys to adjust the 4 mA signal.  <b>NOTE:</b> When increasing or decreasing the mA signal, the increments of change increase with successive depressions until the maximum level of change is reached. By changing direction you will return to the smallest increment of change. This adjustment technique speeds up the adjustment process without affecting fine adjustment.
	<div data-bbox="597 1577 932 1709" style="border: 1px solid black; padding: 5px;">                     ADJUST TO 20 mA                       THEN HIT ENTER                 </div>	Use the arrow keys to adjust the 20 mA signal.

# TBN580 TRANSMITTER

---

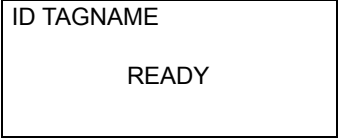
Key	Display	Comments
		

# APPENDIX L - TBN581 (ORP/pION) TRANSMITTER

## INTRODUCTION

This appendix covers the configuration and calibration functions of the TBN581 (ORP/pION) Transmitter.

Refer to **OPERATING PROCEDURES** in Section 4 for information on the following functions:

- Send configurations.
- Get configurations.
- View configurations.
- Select configurations.
- Erase configurations.
- Operational functions.

**NOTE:** To change calibration or configuration parameters of a smart field device that is connected to an IMFBS01 module, the device must be taken off-line. This is done at the INFI 90 OPEN console.

## CREATE/MODIFY CONFIGURATION

A configuration can be created off-line, without a connected field device. Refer to Figure L-1 for an overview of the configuration function. The following table details the configuration process.

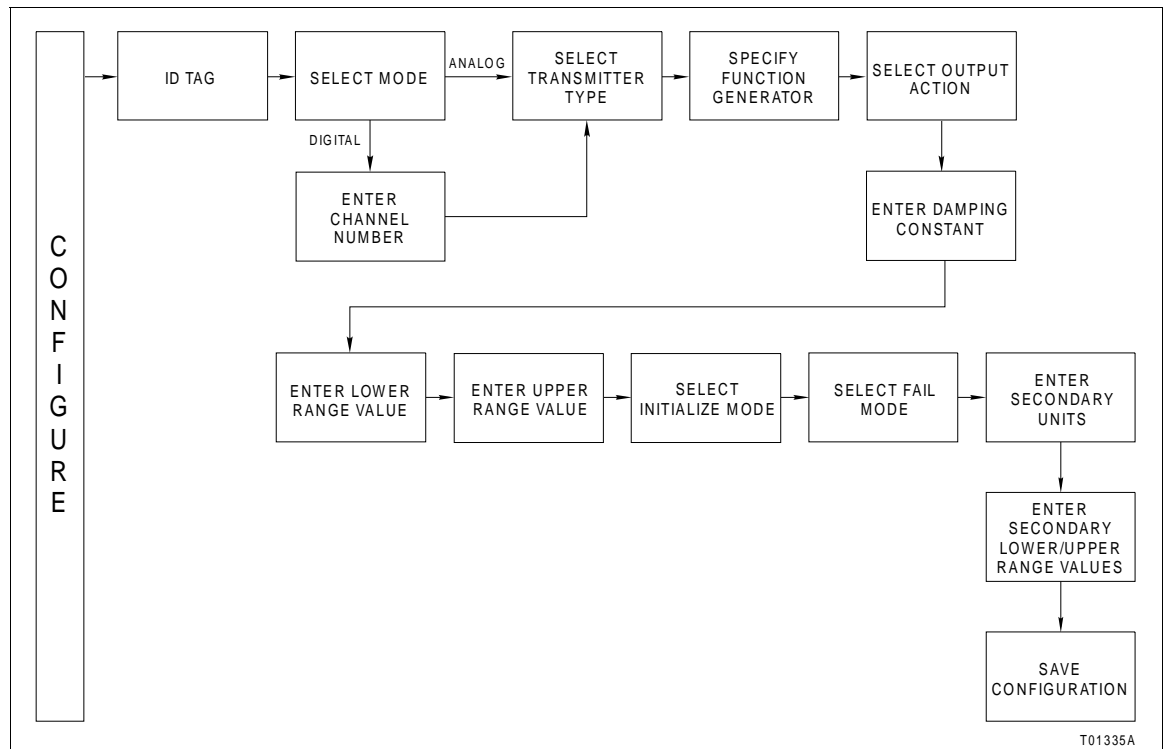







Figure L-1. Configuration Flowchart (TBN581)



Key	Display	Comments
ENTER	TRANSMITTER TYPE cond TBN pH TBN → ORP/pION	Select <i>ORP/pION</i> .
↓		
↓		
ENTER	OUTPUT FUNC GEN → NO YES	Select <i>NO</i> . If <i>YES</i> is selected enter 5 input and output points. Values must be between 0 and 100%.
ENTER	OUTPUT ACTION: → NORMAL REVERSE	Refer to <b>Smart (ORP/pION) Transmitter Series TBN581</b> instruction for description.
ENTER	DAMPING: (0-32 SEC)  _nn.nn	Enter a value between 0 and 32. Refer to the <b>Smart (ORP/pION) Transmitter Series TBN581</b> instruction for description.
ENTER	LOWER RANGE VAL nnn.nn mV UPPER RANGE VAL nnn.nn mV	Enter the lower range temperature value and press <b>ENTER</b> . Input the upper range value. Low default value: -1000 mV. High default value: +1000 mV.
ENTER	INITIALIZE MODE: → LOW HIGH	Refer to the <b>Smart (ORP/pION) Transmitter Series TBN581</b> instruction for description.
ENTER	FAIL MODE: → LOW HIGH LAST	Refer to the <b>Smart (ORP/pION) Transmitter Series TBN581</b> instruction for description.

## TBN581 (ORP/pION) TRANSMITTER

Key	Display	Comments
	ENTER SECONDARY UNITS _nnnnnn	Enter up to 6 characters. Use familiar units to describe the output.
	SECONDARY L.R. _nn.nn UNITS SECONDARY U.R. nn.nn UNITS	Input the lower range value and press <b>ENTER</b> . Input the upper range value.
 	STORE THIS CONFIGURATION NO → YES	Select <b>YES</b> to store the configuration.
	ID TAGNAME  READY	The Configuration ID tag name just configured will be in the upper left corner if the configuration is saved. It becomes the working configuration.  <b>NOTE:</b> Connect the terminal to a device and send the configuration (using <b>SEND CONFIG</b> ) to a device before calibrating.

### CALIBRATION

This section details the calibration functions of the STT04 terminal while interfacing a TBN581 ORP/pION transmitter. There are four types of calibration functions:

- Process calibration.
- Bench calibration (ORP/pION).
- Bench calibration (mV).
- D-to-A adjust.

**NOTES:**

1. When calibrating, a field device must be connected to the STT04 terminal.
2. To change calibration or configuration parameters of a field device that is connected to an IMFBS01 module, the transmitter must be taken off-line. This is done at the INFI 90 OPEN console.

Refer to Figure L-2 for an overview of the calibration functions.

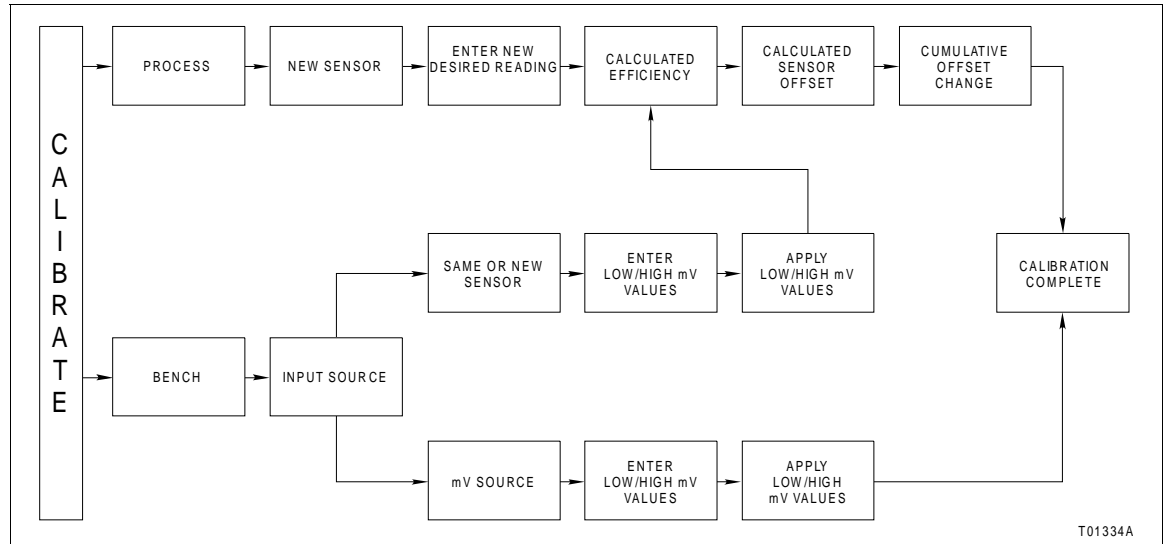

Figure L-2. Calibration Flowchart (TBN581)





**Process Calibration**

This procedure applies to TBN581 Transmitters configured for either *ANALOG* or *DIGITAL*. Any differences between the two are noted in the **Comments** column.

Key	Display	Comments
CALI-BRATE ↓	OUTPUT WILL BE AFFECTED! PROCEED? NO → YES	This operation will cause a change in output not corresponding to the input. Be sure the control loop is in manual.  Select YES.
ENTER	CALIBRATION → PROCESS CAL BENCH CAL D-TO-A ADJUST	Select <i>PROCESS CAL</i> . If configured digitally, the <i>D-TO-A ADJUST</i> selection would not appear.
ENTER	INSTALLING A NEW SENSOR? → NO YES	Select NO.  If YES, a new sensor offset will be calculated and the <i>CUMULATIVE OFFSET CHANGE</i> will be reset to 0.00 mV.





## TBN581 (ORP/pION) TRANSMITTER

Key	Display	Comments
	CHANGE EFFICIENCY? nn.nn% HIT ENTER	Value from last calibration. If <i>NEW SENSOR</i> , efficiency will be 98%. This value can be changed if desired. A change in efficiency will affect calibration span.
	CURRENT READING nn.nn mV ENTER DESIRED nn.nn mV	
	CALCULATED SENSOR OFFSET nnn.nn pH HIT ENTER	This value is recalculated during each calibration.
	CUMULATIVE OFFSET CHANGE n.nn pH HIT ENTER	This value shows the offset change over time for a particular sensor. Value resets to 0.00 pH if installing a new sensor.
	ID TAGNAME  READY	

### Bench Calibration (ORP/pION)

This procedure applies to TBN581 Transmitters configured for either *ANALOG* or *DIGITAL*. Any differences between the two are noted in the **Comments** column.

Key	Display	Comments
 	OUTPUT WILL BE AFFECTED! PROCEED? NO → YES	This operation will cause a change in output not corresponding to the input. Be sure the control loop is in manual.  Select <b>YES</b> .

Key	Display	Comments
<p>ENTER</p> <p>↓</p>	<p>CALIBRATION PROCESS CAL → BENCH CAL D-TO-A ADJUST</p>	<p>Select <i>BENCH CAL</i>.</p>
<p>ENTER</p>	<p>INPUT SOURCE: → SAME SENSOR NEW SENSOR mV SOURCE</p>	<p><i>SAME SENSOR: CALCULATED SENSOR OFFSET, CALCULATED EFFICIENCY, and CUMULATIVE OFFSET CHANGE</i> are recalculated.</p> <p><i>NEW SENSOR: CALCULATED SENSOR OFFSET, CALCULATED EFFICIENCY</i> are calculated and <i>CUMULATIVE OFFSET CHANGE</i> is set to 0.00 mV.</p>
<p>ENTER</p>	<p>ENTER LO mV CAL nn.nn mV ENTER HI mV CAL nn.nn mV</p>	<p><i>NOTE: mV SOURCE</i> selection is covered in <b>Bench Calibration (mV)</b>.</p> <p>Low default value: -1000 mV. High default value: +1000 mV. Enter low mV value and press <b>ENTER</b>. Enter high mV value.</p>
<p>ENTER</p>	<p>APPLY nn.nn mV nn.nn HIT ENTER WHEN STABLE</p>	<p>Displays low mV calibration value, and the uncalibrated mV values determined from the input source.</p>
<p>ENTER</p>	<p>APPLY nn.nn mV nn.nn HIT ENTER WHEN STABLE</p>	<p>Displays high mV calibration value, and the uncalibrated mV values determined from the input source.</p>
<p>ENTER</p>	<p>CALCULATED EFFICIENCY nnn.n % HIT ENTER</p>	<p>Value from last calibration. If new sensor, efficiency will be 98%.</p>
<p>ENTER</p>	<p>CALCULATED SENSOR OFFSET nnn pH HIT ENTER</p>	<p>This value is recalculated during each calibration.</p>

## TBN581 (ORP/pION) TRANSMITTER

Key	Display	Comments
ENTER	CUMULATIVE OFFSET CHANGE nnn pH HIT ENTER	This value shows the offset change over time for a particular sensor. Value resets to 0.00 mV if installing a new sensor.
ENTER	ID TAGNAME  READY	Calibration complete.

### Bench Calibration (mV)

This procedure applies to TBN581 Transmitters configured for either *ANALOG* or *DIGITAL*. Any difference between the two are noted in the **Comments** column.

Key	Display	Comments
CALIBRATE	OUTPUT WILL BE AFFECTED! PROCEED? NO → YES	This operation will cause a change in output not corresponding to the input. Be sure the control loop is in manual. Select <b>YES</b> .
↓		
ENTER	CALIBRATION PROCESS CAL → BENCH CAL D-TO-A ADJUST	Select <b>BENCH CAL</b> .
↓		
ENTER	INPUT SOURCE: SAME SENSOR NEW SENSOR → mV SOURCE	Select <b>mV SOURCE</b> .
ENTER	ENTER LO mV CAL nn.nn mV ENTER HI mV CAL nn.nn mV	Low default value: -1000 mV. High default value: +1000 mV. Enter low mV value and press <b>ENTER</b> . Enter high mV value.

Key	Display	Comments
ENTER	APPLY nn.nn mV nn.nn mV HIT ENTER WHEN STABLE	Displays low mV calibration value, and the uncalibrated mV values determined from the input source.
ENTER	APPLY nn.nn mV nn.nn mV HIT ENTER WHEN STABLE	Displays high mV calibration value, and the uncalibrated mV values determined from the input source.
ENTER	ID TAGNAME  READY	



**D-to-A Adjust**

The *D-TO-A ADJUST* selection is only present when you are in the *ANALOG* communication mode, specified in the configuration procedure. This selection allows you to adjust the four to 20 milliampere output of the field device.

Key	Display	Comments
CALIBRATE	OUTPUT WILL BE AFFECTED! PROCEED? NO → YES	This operation will cause a change in output not corresponding to the input. Be sure the control loop is in manual.  Select YES.
↓		
ENTER	CALIBRATION → D-TO-A ADJUST BENCH CALIB.	Select <i>D-TO-A ADJUST</i> .
ENTER	ADJUST TO 4 mA  THEN HIT ENTER	Use the arrow keys to adjust the 4 mA signal.  <b>NOTE:</b> When increasing or decreasing the mA signal, the increments of change increase with successive depressions until the maximum level of change is reached. By changing direction you will return to the smallest increment of change. This adjustment technique speeds up the adjustment process without affecting fine adjustment.

# TBN581 (ORP/pION) TRANSMITTER

---

Key	Display	Comments
	<p>ADJUST TO 20 mA</p> <p>THEN HIT ENTER</p>	Use the arrow keys to adjust the 20 mA signal.
	<p>ID TAGNAME</p> <p>READY</p>	

# APPENDIX M - TZID/AZH POSITIONER

## INTRODUCTION

This appendix covers the configuration, calibration and special feature functions of the TZID/AZH Positioner. Table M-1 lists the error and problem codes of the TZID/AZH positioner.

Refer to **OPERATING PROCEDURES** in Section 4 for information on the following functions:

- Send configurations.
- Get configurations.
- View configurations.
- Select configurations.
- Erase configurations.
- Operational functions.

## CREATE/MODIFY CONFIGURATION

A configuration can be created off-line, without a connected field device. Refer to Figure M-1 for an overview of the configuration function. The following table details the configuration process.

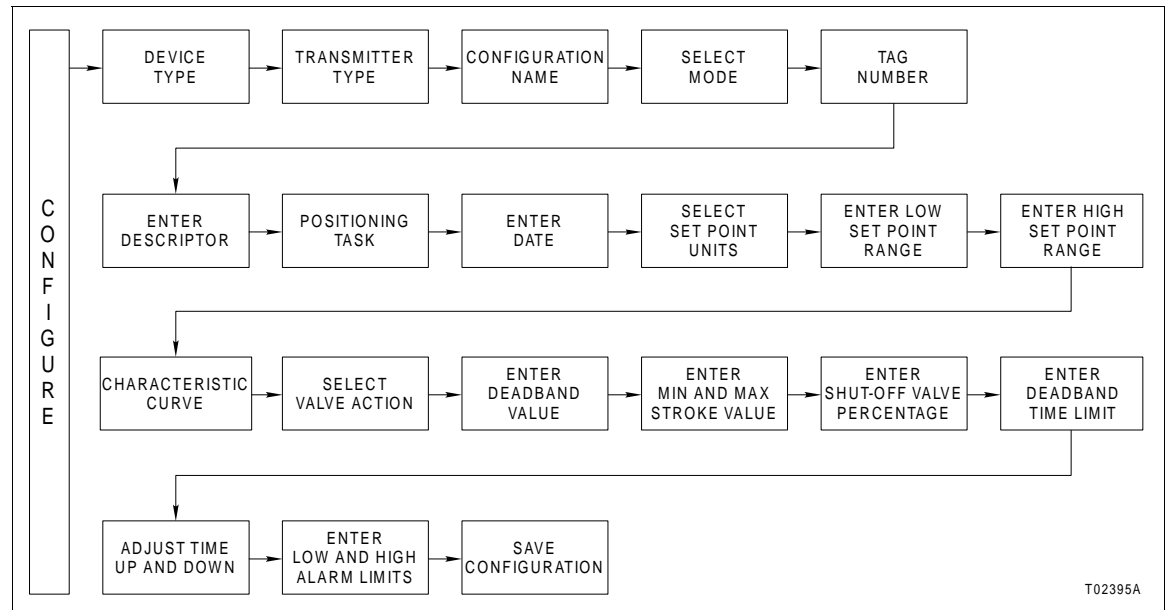











Figure M-1. Configuration Flowchart (TZID/AZH)









# TZID/AZH POSITIONER

Key	Display	Comments
	<div style="border: 1px solid black; padding: 5px;">           CONFIGURATION            → NEW              MODIFY              ERASE         </div>	<p>Select <i>NEW</i> to create a configuration. To modify an existing configuration, select <i>MODIFY</i>. The screen sequence is the same, however, the <i>MODIFY</i> screens will appear with the values and arrow positions as they were originally configured.</p>
 	<div style="border: 1px solid black; padding: 5px;">           DEVICE TYPE              ABB FSK            → HART         </div>	<p>Select <i>HART</i>.</p>
  	<div style="border: 1px solid black; padding: 5px;">           TRANSMITTER TYPE            TB82 pH   TB82 ORP            TB82 pION TB82 CONC            → TZID/AZH   HART UNIV         </div>	<p>Select <i>TZID/AZH</i>.</p>
	<div style="border: 1px solid black; padding: 5px;">           STT04 CONFIGURATION            [                    ]                       ←PREVIOUS       NEXT→         </div>	<p>Enter a name for the configuration ID tag using up to 8 ASCII characters. To select a character, press the key that has the desired character. Continue to press the key until the desired character appears. Use the right arrow key to move to the next character. Use the left arrow key to go back to the previous character.</p>
	<div style="border: 1px solid black; padding: 5px;">           SELECT MODE:            → ANALOG              DIGITAL         </div>	<p>Select <i>ANALOG</i>.</p> <p><b>NOTE:</b> The <i>DIGITAL</i> selection should only be made when using the device in multidrop mode. A <i>CHANNEL #</i> prompt appears when <i>DIGITAL</i> is selected.</p>
	<div style="border: 1px solid black; padding: 5px;">           TAG NUMBER            ←PREVIOUS       NEXT→         </div>	<p>Enter up to 32 characters (ASCII) of descriptive text in this field.</p>

Key	Display	Comments
ENTER	DESCRIPTOR: ←PREVIOUS NEXT→	Type a descriptor string using up to 16 characters. This field can be used for notations about the device or process.  To select a character, press the key that has the desired character. Continue to press the key until the desired character appears. Use the right arrow key to move to the next character. Use the left arrow key to go back to the previous character.
ENTER	POSITIONING TASK: - ←PREVIOUS NEXT→	Enter up to 32 characters to describe the positioning task.
ENTER	DATE: DAY: nn MONTH: nn YEAR: nnnn	Enter a day and press <b>ENTER</b> . Enter a month and press <b>ENTER</b> . Enter a year and press <b>ENTER</b> .  This date can represent the creation date of the configuration, the date the device or element was installed, or some other significant date.
ENTER	SET-POINT UNITS → mA %	Select <i>mA</i> .
ENTER	LOW SET-POINT RANGE 4.00 mA HIGH SET-POINT RANGE 20.00 mA	Enter the low set point and press <b>ENTER</b> . Enter the high set point.
ENTER	CHARACTERISTIC CURVE → LINEAR EQUAL % 1:25 EQUAL % 1:50	Additional selections include <i>EQUAL% 25:1</i> and <i>EQUAL% 50:1</i> and <i>USER DEFINED</i> .  <i>USER DEFINED</i> is present only if a characteristic curve had been previously defined. Refer to <b>SPECIAL FEATURE</b> in this section for details about defining a characteristic curve.
ENTER	VALVE ACTION → DIRECT REVERSE	Represents the relationship between input current and movement of the valve.
ENTER	DEADBAND (0 - 10%)  0.00%	Defines the accuracy with which the valve position is corrected to reach the set point. If control deviation is smaller than the value defined by the deadband, no further correction occurs, and the air output is set to the neutral position.



# TZID/AZH POSITIONER

Key	Display	Comments
	MIN STROKE RANGE: 0.00 % MAX STROKE RANGE: 100.00 %	Use the stroke range to further reduce the valve range given by the valve stops.
	SHUT-OFF VALUE (0 - 20 %)  nn.nn %	A percentage of the input current where the zero point occurs.
	DEADBAND TIME LIMIT (0 - 200 sec)  n.nn sec	Monitors the control deviation. If the valve can not be positioned correctly within the deadband time limit, an error message is generated.
	ADJUSTED TIME, UP nn.nn sec ADJUSTED TIME, DOWN nn.nn sec	Specify time using the number keypad. This parameter provides electronic damping of the valve stroke movement and limits stroke speed to the specified value.
	LOW ALARM LIMIT nn.nn % HIGH ALARM LIMIT nn.nn %	Low and high alarm limits are user configurable alarms.  <b>NOTE:</b> Use <b>BACK</b> to return to a previous configuration screen from any screen in the configuration process.
	STORE THIS CONFIGURATION? NO → YES	Select YES.
		
	ID TAGNAME  READY	

**CALIBRATION**

This section details the TZID/AZH positioner calibration functions using an STT04 terminal.

**NOTE:** When calibrating, a field device must be connected to the STT04 terminal.

Refer to Figure M-2 for an overview of the calibration functions.

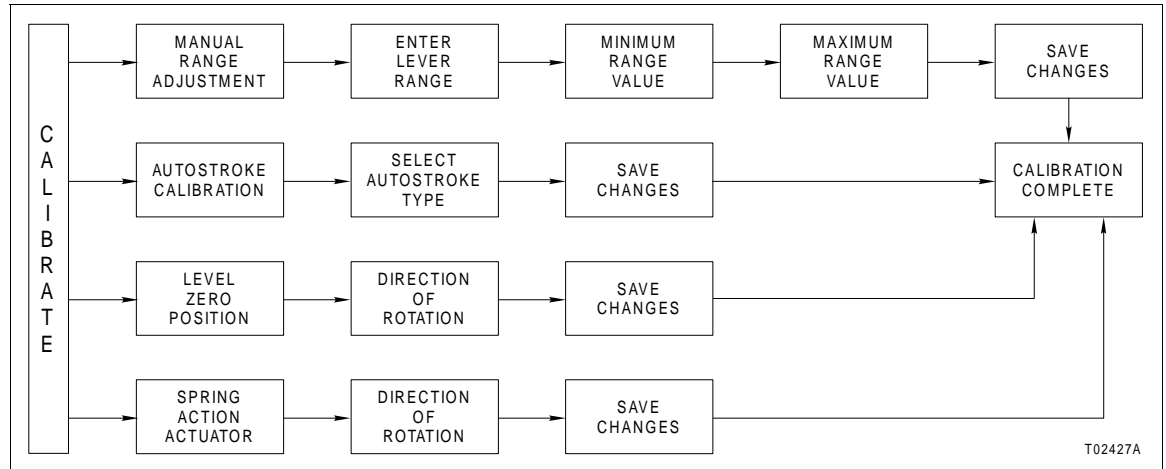



Figure M-2. Calibration Flowchart (TZID/AZH)

**Autostroke Calibration**

The Autostroke function determines:

- Valve range.
- Controller settings.

Key	Display	Comments
	→AUTOSTROKE MANUAL RANGE ADJUST LEVER ZERO POSITION SPRING ACTION ACTUA	Select <i>AUTOSTROKE</i> .  Run autostroke after mounting, after changes to the mechanical link, or when the controlled system has been modified.





## TZID/AZH POSITIONER

Key	Display	Comments
ENTER	→FULL AUTOSTROKE CONTROL PARAM ONLY VALVE RANGE ONLY ZERO ONLY	Select <i>FULL AUTOSTROKE</i> to adjust all the valve and control parameters.  Select <i>CONTROL PARAM ONLY</i> to adjust adaptation time, noise, Kp value, Tv value, and minimum threshold response (increasing/decreasing) or to adjust the control parameters of the positioner.  Select <i>VALVE RANGE ONLY</i> to adjust the zero and span of the positioner.  Select <i>ZERO ONLY</i> to adjust only the zero of the positioner (valid only for TZID/AZH rev 5.x and above).
ENTER	LIMIT STOPS REQUIRED. PROCEED ? NO → YES	Select <i>YES</i> .  <b>NOTE:</b> This screen does not appear when <i>CONTROL PARAM ONLY</i> autostroke is selected. Limit stops are not required for this selection.
↓		
ENTER	AUTOSTROKE STARTED	Autostroke takes between 2 and 5 minutes to complete. A message appears indicating the status of autostroke.
ENTER	ID TAGNAME  READY	When autostroke is successful the <i>READY</i> screen appears. If an error is detected the autostroke error number is displayed on the screen. Refer to the TZID/AZH instruction for error number descriptions.

### Manual Range Adjustment



This function is used to adjust the minimum and maximum valve positions.

Key	Display	Comments
CALIBRATE	AUTOSTROKE →MANUAL RANGE ADJUST LEVER ZERO POSITION SPRING ACTION ACTUA	Select <i>MANUAL RANGE ADJUST</i> .
↓		

Key	Display	Comments
                      	<div data-bbox="597 258 932 394" style="border: 1px solid black; padding: 5px;">                     ENTER VALVE RANGE AS % LEVER RANGE. VALVE RANGE MUST NOT BE LESS THAN 10 %                 </div> <div data-bbox="597 453 932 590" style="border: 1px solid black; padding: 5px;">                     MIN VALVE RANGE nnn.nn % MAX VALVE RANGE nnn.nn %                 </div> <div data-bbox="597 648 932 785" style="border: 1px solid black; padding: 5px;">                     MAKE CHANGES PERMANENT ? NO → YES                 </div> <div data-bbox="597 938 932 1075" style="border: 1px solid black; padding: 5px;">                     ID TAGNAME READY                 </div>	<p>Enter a minimum valve range and press <b>ENTER</b>.</p> <p>Enter a maximum valve range.</p> <p>Select <b>YES</b> to make the changes permanent.</p> <p>Manual range adjust is complete.</p>

**Lever Zero Position**

This function assigns the zero position of the lever range to one of the stops. The lever zero position determines whether the zero position of the valve is allocated to the lever shaft turning counterclockwise or turning clockwise (looking into the open device cover).

Key	Display	Comments
    	<div data-bbox="597 1438 932 1575" style="border: 1px solid black; padding: 5px;">                     AUTOSTROKE MANUAL RANGE ADJUST →LEVER ZERO POSITION SPRING ACTION ACTUA                 </div>	<p>Select <i>LEVER ZERO POSITION</i>.</p>

## TZID/AZH POSITIONER

Key	Display	Comments
ENTER	LEVER SHAFT STOP TURNING → CLOCKWISE COUNTER CLOCKWISE	Select the appropriate direction of rotation.  <b>NOTE:</b> Direction of rotation is looking into the open cover of the positioner.
ENTER	MAKE CHANGES PERMANENT ? NO → YES	Select YES to make the changes permanent.
↓		
ENTER	ID TAGNAME READY	Lever zero position is complete.

### Spring Action Actuator

This function defines the stop to which the valve is set by the spring action of a single acting actuator.

Key	Display	Comments
CALIBRATE	AUTOSTROKE MANUAL RANGE ADJUST LEVER ZERO POSITION →SPRING ACTION ACTUA	Select <i>SPRING ACTION ACTUA</i> .
CALIBRATE	LEVER SHAFT/ ACTUATOR TURNING → CLOCKWISE COUNTER CLOCKWISE	Select the appropriate direction.  <b>NOTE:</b> Direction of rotation is looking into the open cover of the positioner.
ENTER	MAKE CHANGES PERMANENT ? NO → YES	Select YES to make the changes permanent.
↓		





Key	Display	Comments
	<div style="border: 1px solid black; padding: 5px;">                     ID TAGNAME                       READY                 </div>	Complete.

**SPECIAL FEATURE**

The following section details unique special feature functions for the TZID/AZH positioner.

**Device Information**

This function shows the current settings of the positioner.

Key	Display	Comments
	<div style="border: 1px solid black; padding: 5px;">                     →DEVICE INFORMATION                      CONTROL PARAMETERS                      CHARACTERIST. CURVE                      OPERATING MODE                 </div>	Select <i>DEVICE INFORMATION</i> .
	<div style="border: 1px solid black; padding: 5px;">                     SOFTWARE REVISION                      n.n                      HARDWARE REVISION                      n.n                 </div>	Shows revision information about the positioner.
	<div style="border: 1px solid black; padding: 5px;">                     LEVER RANGE:                       60 °                 </div>	Shows the maximum range of rotation of the lever arm on the positioner.
	<div style="border: 1px solid black; padding: 5px;">                     FINAL ASSEMBLY #:                       nnnnnnnn                 </div>	Shows the serial number of the positioner as specified at the factory.
	<div style="border: 1px solid black; padding: 5px;">                     I/P MODULE:                      DOUBLE ACTING                      FAIL-SAFE POSITION                      FAIL-FREEZE                 </div>	Shows the I/P MODULE setting of the positioner. Options include: single acting and double acting.  Shows the fail-safe position of the positioner. Options include fail-freeze, and fail-safe.





## TZID/AZH POSITIONER

Key	Display	Comments
	<div style="border: 1px solid black; padding: 5px; width: fit-content; margin: auto;">           ID TAGNAME             READY         </div>	Complete.

### Control Parameters

Use this function to view measured stroke time, view and edit proportional gain, deviation action, go pulse, offset, and noise of the positioner. The screen flow of this section applies for TZID/AZH revision 5.x or greater.

**NOTE:** All control parameters are best determined for most actuators by autostroke. Modify the parameters only if acceptable control action cannot be achieved or if autostroke cannot be performed.









Key	Display	Comments
  	<div style="border: 1px solid black; padding: 5px; width: fit-content; margin: auto;">           DEVICE INFORMATION            →CONTROL PARAMETERS            CHARACTERIST. CURVE            OPERATING MODE         </div>	Select <i>CONTROL PARAMETERS</i> .
	<div style="border: 1px solid black; padding: 5px; width: fit-content; margin: auto;">           STROKE TIME (SEC)             UP:               n.n            DOWN:           n.n         </div>	Shows measured stroke time for up and down positioning directions.
	<div style="border: 1px solid black; padding: 5px; width: fit-content; margin: auto;">           Kp VALUE             UP:               nn.n            DOWN:           nn.n         </div>	Edit Kp value.  Represents the gain of the PD controller and influences the speed and stability of control. A high Kp (proportional gain) value increases control speed.
	<div style="border: 1px solid black; padding: 5px; width: fit-content; margin: auto;">           Tv VALUE (mSEC)             UP:               nn.n            DOWN:           nn.n         </div>	Edit the Tv value.  Represents the deviation action of the PD controller. Tv influences the control speed and stability by dynamically counteracting the Kp value. The control speed decreases with an increasing Tv value.

Key	Display	Comments
ENTER	GO PULSE (mSEC) UP:                   nn.n DOWN:               nn.n	Edit the go pulse value. If the actuator is still, the controller provides an amplified output signal for the defined pulse time to achieve a rapid startup of the actuator.
ENTER	OUTPUT OFFSET (%) UP:                   nn.n DOWN:               nn.n	Edit the output offset percentage of the actuator. Output offset linearizes the action of the used I/P module and enables rapid control until reaching the set point. An output offset between 40% and 80% is acceptable for most actuators.
ENTER	ADC NOISE BAND  nn.nnn%	Edit the noise band of A/D conversion. ADC noise band can be used as an interference indicator. If the noise is big, the measuring accuracy and control reaction is affected. Normally an acceptable ADC noise band value is between 0.03% and 0.05%.
ENTER	I/P MODULE: UNIPOLAR, SINGLE ACT BIPOLAR, SINGLE ACT UNIPOLAR, DOUBLE ACT BIPOLAR, DOUBLE ACT	Select the <i>I/P MODULE</i> setting. This defines the triggering or safe position to the built-in I/P module. The setting must be the same as the existing I/P module in the TZID/AZH positioner.
ENTER	SEND CONTROL PARAMETERS ? NO → YES	Select YES if changes were made to the parameters.
ENTER	MAKE CHANGES PERMANENT ? NO → YES	Select YES to make the changes permanent.
↓		
ENTER	ID TAGNAME  READY	



**Characteristic Curve**

Use this function to create a user-defined characteristic curve by setting input and output points.

Key	Display	Comments
	DEVICE INFORMATION CONTROL PARAMETERS →CHARACTERIST. CURVE OPERATING MODE	Select <i>CHARACTERIST. CURVE</i> .
		
		
	CHARACTERIST. CURVE NEW → MODIFY ERASE	<i>MODIFY</i> and <i>ERASE</i> selections appear if a characteristic curve is already defined in the device. The characteristic curve is defined by 22 reference points.
	POINT 1 INP (%) nn.nn POINT 1 OUT (%) nn.nn	Point 1 and point 22 are fixed at 0 and 100% respectively.
	POINT 2 INP (%) nn.nn POINT 2 OUT (%) nn.nn	Enter an input point and press <b>ENTER</b> . Enter an output point. Specify input and output values for points 2 through 21.
	POINT 21 INP (%) nn.nn POINT 21 OUT (%) nn.nn	Each set of reference points must be greater than the previous set of points.
	SEND CURVE VALUES? NO → YES	Select <i>YES</i> to send the values to the positioner.

Key	Display	Comments
ENTER	MAKE CHANGES PERMANENT? NO → YES	Select <i>YES</i> to save changes.
ENTER	ID TAGNAME  READY	

**Operating Mode**

Use this function to change operating modes. The screen flow of this section applies for TZID/AZH positioners with revision 5.x or greater.

Key	Display	Comments
SPECIAL FEATURE	DEVICE INFORMATION CONTROL PARAMETERS CHARACTERIST. CURVE →OPERATING MODE	Select <i>OPERATING MODE</i> .
↓		
↓		
↓		
ENTER	→ CONTROLLING, AUTO CONTROLLING, FIXED MANUAL LOCAL	Use this screen to select the operating mode.  Select <i>AUTO</i> for automatic adaptation of the control parameters. Select <i>FIXED</i> for fixed control parameters. Select <i>MANUAL</i> for manual actuation of control element. Select <i>LOCAL</i> to switch over the device from an externally selected operating mode to the internally selected mode.
ENTER	MAKE CHANGES PERMANENT? NO → YES	Select <i>YES</i> to change modes.

# TZID/AZH POSITIONER







---

Key	Display	Comments
	<div style="border: 1px solid black; padding: 5px; width: fit-content; margin: auto;">                     ID TAGNAME                       READY                 </div>	

---

## Device Self Test

Use this function to perform a self-test and report status of the positioner.

Key	Display	Comments
        	<div style="border: 1px solid black; padding: 5px; width: fit-content; margin: auto;">                     CONTROL PARAMETERS                      CHARACTERIST. CURVE                      OPERATING MODE                      →DEVICE SELF TEST                 </div>	Select <i>DEVICE SELF TEST</i> .
	<div style="border: 1px solid black; padding: 5px; width: fit-content; margin: auto;">                     ID TAGNAME                       READY                 </div>	If errors exist the message will display.

**Master Reset**

Use this function to return the positioner to factory settings.

Key	Display	Comments
<p>SPECIAL FEATURE</p> <p>↓</p> <p>↓</p> <p>↓</p> <p>↓</p> <p>↓</p> <p>↓</p>	<p>CHARACTERIST. CURVE OPERATING MODE DEVICE SELF TEST</p>	<p>Select <i>MASTER RESET</i>. This resets the positioner.</p>
<p>ENTER</p>	<p>MAKE CHANGES PERMANENT? NO → YES</p>	<p>Select <i>YES</i> to reset the positioner.</p>
<p>ENTER</p>	<p>ID TAGNAME  READY</p>	

**ERROR MESSAGES (TZID/AZH)**

Table M-1 lists the TZID/AZH positioner error messages in alphabetical order.

*Table M-1. Error Messages for TZID/AZH Positioner*

<b>Message</b>	<b>Description</b>	<b>Corrective Action</b>
ACCESS DENIED, AUTOSTROKE IN PROGRESS	Attempted to change device parameters when autostroke was in process.	Wait for autostroke to complete and then try the operation again.
ALARM LIM SW1 REACH	Valve position below low alarm limit.	This is a warning message indicating a critical valve position.
ALARM LIM SW2 REACH	Alarm limit of SW2 has been reached.	
AUTOSTROKE IS ALREADY STARTED	Attempted to start the autostroke calibration while it was already in progress.	Allow calibration process to finish.
AUTOSTROKE ERROR nn	At the end of autostroke, lists the autostroke error number if any occurred.	Find error number meanings in TZID/AZH instruction manual.
CONTROL NOT ACTIVE	Valve position does not follow set point.  <b>NOTE:</b> An exclamation point (!) following the message indicates that the alarm output is active.	Activate automatic control in operating mode 1.0 or 1.1 to terminate the inactive state.
DEVICE ERROR	Internal data error.	Reset positioner. If problem persists, load standard configuration.
DEADBAND TOO SMALL	Deadband percentage value too small.	Increase deadband percentage value.
DEADBAND TOO LARGE	Deadband percentage too large.	Decrease deadband percentage value.
DIST METR LIMIT EXCD	Limit of distance meter exceeded.	Start valve and positioner diagnosis steps according to maintenance practices.
LEAK TOWARD ACTUATR	Leakage towards actuator detected.	Check tubing of actuator for leaks.
POS OUT OF LEVR RNG	Position out of lever range.	Check if the positioner is mounted properly.
POSITIONING TIMEOUT	Valve position does not follow set point. Alarm output active.	Check air supply pressure and tubing; check actuator, valve and positioner. Increase time limit using STT when hardware is ok.
ROM DEFECTIVE	Positioner ROM is defective.	Call ABB technical support.
SET-PT OUT OF RANGE	Set point is out of range.	Adjust the set point range using the STT.
SHUT-OFF VALUE TOO LARGE	Shut-off value is too large.	Reduce shut-off value.
SHUT-OFF VALUE TOO SMALL	Shut-off value is too small.	Increase shut-off value.
SP NOT RCHD IN TIME	Set point not reached within the deadband time limit.	Check air supply pressure and tubing; check actuator, valve and positioner. Increase time limit using STT when hardware is ok.
	Valve position does not follow set point.	

*Table M-1. Error Messages for TZID/AZH Positioner*

<b>Message</b>	<b>Description</b>	<b>Corrective Action</b>
STROKE COUNT EXCEED	Stroke counter limit exceeded.	Start valve and positioner diagnosis steps according to maintenance practices.
VALUE SHOULD NOT BE LESS THAN PREVIOUS VALUE	User-defined characteristic curve entry error.	Make sure the value last entered is not less than the previous entry.
WATCHDOG DEFECTIVE	Watchdog defect, possible due to EMI.	Eliminate EMI source in the near vicinity.

# APPENDIX N - TB82 TRANSMITTER

## INTRODUCTION

This appendix covers the configuration, calibration and special feature functions of the TB82 transmitter. Table N-1 lists problem codes and Table N-2 lists error codes of the TB82 transmitter.

Refer to **OPERATING PROCEDURES** in Section 4 for information on the following functions:

- Send configurations.
- Get configurations.
- View configurations.
- Select configurations.
- Erase configurations.
- Operational functions.

## CREATE/MODIFY CONFIGURATION

A configuration can be created offline, without a connected field device. Refer to Figure N-1 for an overview of the configuration function. The following table details the configuration process.

This procedure covers pH transmitters. Any differences between other TBI devices will be noted in the **Comments** column.

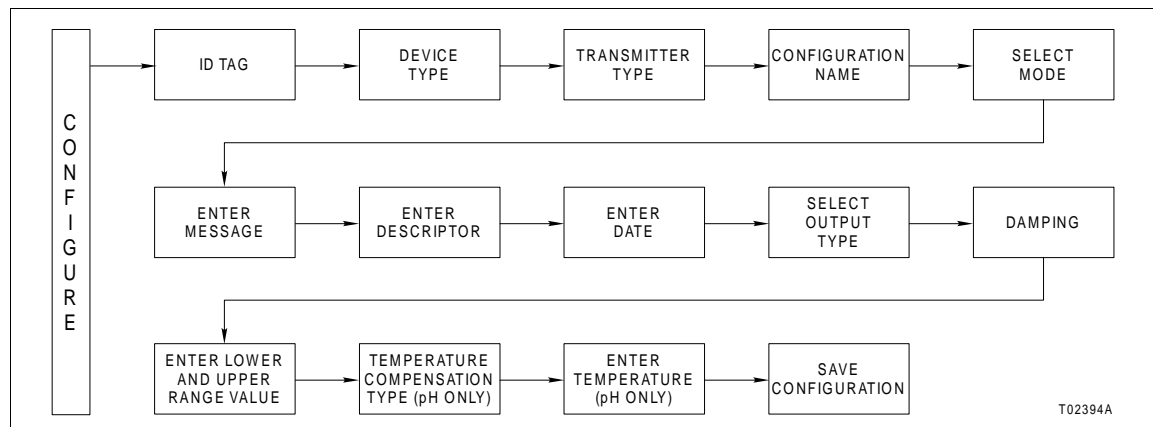



















Figure N-1. Configuration Flowchart (TB82)

# TB82 TRANSMITTER

Key	Display	Comments
	CONFIGURATION → NEW MODIFY ERASE	Select <i>NEW</i> to create a configuration. To modify an existing configuration, select <i>MODIFY</i> . The screen sequence is the same, however, the <i>MODIFY</i> screens will appear with the values and arrow positions as they were originally configured.
 	DEVICE TYPE ABB FSK → HART	Select <i>HART</i> .
 	TRANSMITTER TYPE PTH      EBTH → TB82 pH    TB82 ORP TB82 pION   TB82 CONC	Select a TBI device. The configuration shown here is generalized for all TBI devices. Differences that occur are noted.
	STT04 CONFIGURATION [                    ] ←PREVIOUS      NEXT→	Enter a name for the configuration ID tag using up to 8 ASCII characters. To select a character, press the key that has the desired character. Continue to press the key until the desired character appears. Use the right arrow key to move to the next character. Use the left arrow key to go back to the previous character.
	SELECT MODE: → ANALOG DIGITAL	Select <i>ANALOG</i> .  <b>NOTE:</b> The <i>DIGITAL</i> selection should only be made when using the device in multidrop mode. A <i>CHANNEL #</i> prompt appears when <i>DIGITAL</i> is selected.
	MESSAGE : ←PREVIOUS      NEXT→	Type a descriptive message using up to 32 characters. Use this field to note important information about the device or installation.
	DESCRIPTOR: ←PREVIOUS      NEXT→	Type a descriptor string using up to 16 characters. This field can be used for notations about the device or process.  To select a character, press the key that has the desired character. Continue to press the key until the desired character appears. Use the right arrow key to move to the next character. Use the left arrow key to go back to the previous character.



Key	Display	Comments
	<p>DATE:            DAY: nn            MONTH: nn            YEAR: nnnn</p>	<p>Enter a day and press <b>ENTER</b>. Enter a month and press <b>ENTER</b>. Enter a year.</p> <p>This date can represent the creation date of the configuration, the date the device or element was installed, or some other significant date.</p>
	<p>OUTPUT TYPE:            → LINEAR            FUNC GENERATOR</p>	<p>Select <i>Linear</i>.</p> <p>The <i>OUTPUT TYPE</i> screen does not appear when the transmitter type is <i>TB82 CONC</i>.</p>
	<p>DAMPING:            (0 - 100 sec)</p>	<p>Enter a value between 0 and 100. Damping is used to smooth out a noisy signal. Use a low value for a clean signal and a higher number for noisy signals. Default setting is 0.5 seconds.</p>
	<p>LOWER RANGE VAL            nn.nn UNITS            UPPER RANGE VAL            nn.nn UNITS</p>	<p>Enter a value between 0 and 100. Damping is used to smooth out a noisy signal. Use a low value for a clean signal and a higher number for noisy signals. Default setting is 0.5 seconds.</p> <p>The <i>DAMPING</i> screen does not appear when the transmitter type is <i>TB82 CONC</i>.</p>
	<p>TEMP COMP TYPE            → MANUAL            AUTOMATIC            AUTO SOL. (ADV)</p>	<p>Input lower range value (4 mA) using the arrow keys, then press <b>ENTER</b>. Input the upper range value (20 mA).</p> <p>The range values screen does not appear when the transmitter type is <i>TB82 CONC</i>.</p>
	<p>TEMP COMP TYPE            → MANUAL            AUTOMATIC            AUTO SOL. (ADV)</p>	<p>Select a temperature compensation type.</p> <p>This screen appears for TB82 pH.</p>
	<p>ENTER TEMPERATURE:            nn.nn UNITS</p>	<p>Enter a temperature.</p> <p>This screen appears for TB82 pH and only if <i>MANUAL</i> is the temperature compensation type.</p>
	<p>STORE THIS CONFIGURATION?            NO            → YES</p>	<p>Select <i>YES</i>.</p>
		

Key	Display	Comments
<div style="border: 1px solid black; padding: 5px; width: 40px; margin: auto;">ENTER</div>	ID TAGNAME READY	

**CALIBRATION**

This section details the TB82 transmitter calibration functions using an STT04 terminal.

**NOTE:** When calibrating, a field device must be connected to the STT04 terminal.

Refer to Figure N-2 for an overview of the calibration functions.

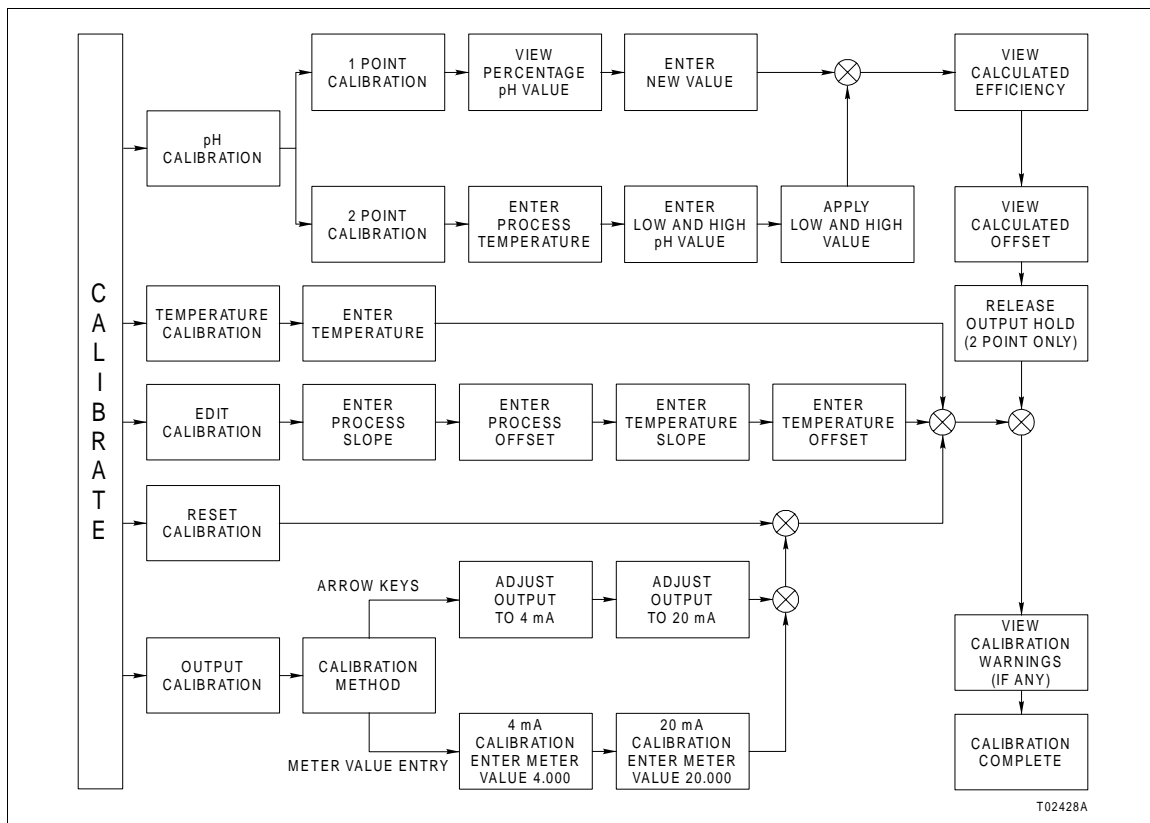

Figure N-2. Calibration Flowchart (TB82)

**One-point Calibration**

This procedure describes how to perform a one-point calibration. This procedure is generalized for all TB82 devices (pH, ORP, pION and CONC). Differences between devices are noted in the **Comments** column of the table.

One-point calibration conducts an offset adjustment on the sensor input. Use this type of calibration when the sensor is in the final installed location.

Key	Display	Comments
CALI- BRATE	OUTPUT WILL BE AFFECTED! PROCEED? NO → YES	This operation will cause a change in output not corresponding to the input. Be sure the control loop is in manual. Select YES.
↓		
ENTER	→ nnnn CAL TEMP. CAL EDIT CAL RESET CAL	Select a calibration type. Throughout this procedure the variable nnnn represents one of the following device types: <i>pH</i> <i>ORP</i> <i>PION</i> <i>CONC</i>
ENTER	nnnn CAL → 1 POINT CAL 2 POINT CAL	Select 1 POINT CAL. Use this calibration method when the sensor is in its final location.
ENTER	nn.nn UNITS  PRESS ENTER WHEN STABLE	Displays the current input value.
↓		
ENTER	ENTER NEW VALUE  _ nn.nn UNITS	Enter the desired value.
ENTER	CALCULATED EFFICIENCY nn.n % PRESS ENTER	The terminal displays the calculated efficiency in percentage.

## TB82 TRANSMITTER

Key	Display	Comments
ENTER	CALCULATED SENSOR OFFSET nnn.n mV PRESS ENTER	The terminal displays the calculated sensor offset in millivolts.
ENTER	ID TAGNAME  READY	If any warnings or messages exist pertaining to this device, the terminal will list them.

### Two-point Calibration







Two-point calibration conducts an offset and slope adjustment on a sensor to determine response characteristics before final location installation.

Key	Display	Comments
CALIBRATE	OUTPUT WILL BE AFFECTED! PROCEED? NO → YES	This operation will cause a change in output not corresponding to the input. Selecting YES will hold the output during calibration.  Select YES.
↓		
ENTER	→ nnnn CAL TEMP. CAL EDIT CAL RESET CAL	Select a calibration type.  Throughout this procedure the variable nnnn represents one of the following device types: <i>pH</i> <i>ORP</i> <i>PION</i> <i>CONC</i>
ENTER	nnnn CAL 1 POINT CAL → 2 POINT CAL	Select 2 POINT CAL.
↓		

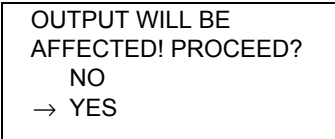
Key	Display	Comments
ENTER	ENTER PROCESS TEMPERATURE  nn.nn °C	Enter a process temperature value.  This screen appears only for 2 POINT CAL when performing a pH CAL. 25°C is the default value.
ENTER	LOW CALIB nn UNITS HIGH CALIB nn UNITS	Enter the low value of the buffer or standard and press <b>ENTER</b> . Enter the high value.  The low default value is 4.0 pH. The high default value is 7.0 pH.
ENTER	APPLY n.nn UNITS  PRESS ENTER WHEN STABLE	Apply the low value of the buffer or standard.
ENTER	APPLY n.nn UNITS  PRESS ENTER WHEN STABLE	Apply the high value of the buffer or standard.
ENTER	CALCULATED EFFICIENCY nn.n % PRESS ENTER	The terminal displays the calculated efficiency in percentage.
ENTER	CALCULATED SENSOR OFFSET nnn.n mV PRESS ENTER	The terminal displays the calculated sensor offset in millivolts.
ENTER	RELEASE OUTPUT HOLD NO → YES	Select YES to release output hold. Screen appears at the end of two-point calibration when device is in the analog mode.
↓		
ENTER	ID TAGNAME  READY	If any warnings or messages exist pertaining to this device, the terminal will list them.

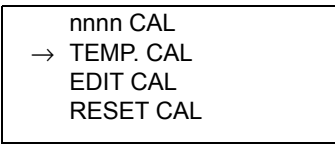

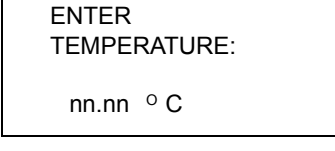

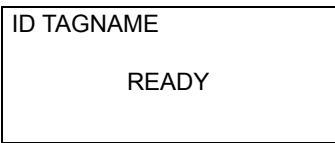



**Temperature Calibration**

This procedure describes how to perform a temperature calibration.

Key	Display	Comments
		<p>This operation will cause a change in output not corresponding to the input. Selecting YES will hold the output during calibration.</p> <p>Select YES.</p>
		
		<p>Select TEMP. CAL.</p>
		
		<p>Enter the temperature. Default temperature is 25°C.</p>
		









**Edit Calibration**

This procedure describes how to edit a calibration.

Key	Display	Comments
	<p>OUTPUT WILL BE AFFECTED! PROCEED? NO → YES</p>	<p>This operation will cause a change in output not corresponding to the input. Selecting YES will hold the output during calibration. Select YES.</p>
		
	<p>nnnn CAL TEMP. CAL → EDIT CAL RESET CAL</p>	<p>Select <i>EDIT CAL</i>.</p>
		
		
	<p>PROCESS  SLOPE :     nnn.nnnn OFFSET:     nnnn.nnnn</p>	<p>Enter the sensor slope value and press <b>ENTER</b>. Valid values are 40% to 150%.  Enter a sensor offset value. Valid values are -1,000 to +1,000 mV.</p>
	<p>TEMPERATURE  SLOPE :     nn.nnnn OFFSET:     nnn.nnnn</p>	<p>Enter a temperature slope value and press <b>ENTER</b>. Valid range is 0.2 to 1.5.  Enter a temperature offset value. Valid range is -40° to 40°C.</p>
	<p>ID TAGNAME  READY</p>	<p>If any warnings or messages exist pertaining to this device, the terminal will list them.</p>

**Reset Calibration**









This procedure describes how to reset a calibration back to the default settings.

Key	Display	Comments
	<div style="border: 1px solid black; padding: 5px;">                     OUTPUT WILL BE                      AFFECTED! PROCEED?                      NO                      → YES                 </div>	This operation will cause a change in output not corresponding to the input. Selecting YES will hold the output during calibration.  Select YES.
		
	<div style="border: 1px solid black; padding: 5px;">                     nnnn CAL                      TEMP. CAL                      EDIT CAL                      → RESET CAL                 </div>	Select <i>RESET CAL</i> .  This function sets all process sensor and temperature sensor calibration data to the default settings. The following are the factor settings.
		Sensor slope: 100 % Sensor offset: 0 mV
		Temperature slope: 1
		Temperature offset: 0°C
	<div style="border: 1px solid black; padding: 5px;">                     OUTPUT WILL BE                      AFFECTED! PROCEED?                      NO                      → YES                 </div>	Select YES to reset the calibration.
		
	<div style="border: 1px solid black; padding: 5px;">                     ID TAGNAME                       READY                 </div>	





**Output D/A Calibration**

Output D/A Calibration is used to trim the output signal to maintain precise transmission of the process variable. The procedure that follows details output adjustment using the arrow keys. Adjustment can be made by meter value entry. Refer to [Appendix B](#) for details pertaining to meter value entry adjustment.

Key	Display	Comments
	<div data-bbox="597 520 932 659" style="border: 1px solid black; padding: 5px;">                     OUTPUT WILL BE AFFECTED! PROCEED? NO → YES                 </div>	This operation will cause a change in output not corresponding to the input. Selecting YES will hold the output during calibration.  Select YES.
		
	<div data-bbox="597 814 932 953" style="border: 1px solid black; padding: 5px;">                     nnnn CAL EDIT CAL RESET CAL → OUTPUT D/A CAL                 </div>	Select OUTPUT D/A CAL.
		
		
		
	<div data-bbox="597 1213 932 1352" style="border: 1px solid black; padding: 5px;">                     D/A CAL USING → UPDOWN ARROW KEYS METER VALUE ENTRY                 </div>	Select UPDOWN ARROW KEYS. Use the arrow keys to adjust the output to a value other than 4 or 20 mA.
		Use the METER VALUE ENTRY to adjust the output to 4 and 20 mA. Refer to <a href="#">Appendix B</a> for details about meter value entry.
	<div data-bbox="597 1444 932 1583" style="border: 1px solid black; padding: 5px;">                     ADJUST TO 4 mA  THEN HIT ENTER                 </div>	Use the arrow keys to adjust output to 4 mA.
		<p><b>NOTE:</b> When increasing or decreasing the mA signal, the increments of change increase with successive depressions until the maximum level of change is reached. By changing direction you will return to the smallest increment of change. This adjustment technique speeds up the adjustment process without affecting fine adjustment.</p>

## TB82 TRANSMITTER





Key	Display	Comments
	<div style="border: 1px solid black; padding: 5px; width: fit-content;">           ADJUST TO 20 mA             THEN HIT ENTER         </div>	Use the arrow keys to adjust output shown on the meter to 20 mA.
	<div style="border: 1px solid black; padding: 5px; width: fit-content;">           ID TAGNAME             READY         </div>	

### SPECIAL FEATURE

The following section details unique special feature functions for the TB82.

#### Sensor Data

This procedure describes how to view sensor data.







Key	Display	Comments
	<div style="border: 1px solid black; padding: 5px; width: fit-content;">           FIX/CANCEL OUTPUT            → SENSOR DATA            HART SP. FEATURE         </div>	Select <i>SENSOR DATA</i> .
		
	<div style="border: 1px solid black; padding: 5px; width: fit-content;">           PROCESS             SLOPE :      nn.nnnn            OFFSET:      nn.nnnn         </div>	View slope and offset of the process. Valid slope values are 40% to 150%. Valid offset values are -1,000 to +1,000 mV.
	<div style="border: 1px solid black; padding: 5px; width: fit-content;">           TEMPERATURE             SLOPE :      nn.nnnn            OFFSET:      nn.nnnn         </div>	View slope and offset of the temperature. Valid range for slope is 0.2 to 1.5. Valid range for offset is -40° to 40°C.
	<div style="border: 1px solid black; padding: 5px; width: fit-content;">           ID TAGNAME             READY         </div>	

**HART Special Feature**

This section describes the HART special features under the special feature key relating to the TB82.

**Sensor Setup**

Use this special feature function to view the upper and lower limits and the minimum span, serial number, and final assembly number of the sensor.

Key	Display	Comments
    	<div style="border: 1px solid black; padding: 5px; text-align: center;">                     FIX/CANCEL OUTPUT                      SENSOR DATA                      → HART SP. FEATURE                 </div>	Select <i>HART SP. FEATURE</i> .  Refer to <b>FIX OUTPUT/CANCEL FIX OUTPUT</b> in Section 4 for details about fix and cancel fix output.
	<div style="border: 1px solid black; padding: 5px; text-align: center;">                     → SENSOR SETUP                      MASTER RESET                      # RESP PREAMBLES                      RST CFG CHANGED                 </div>	Select <i>SENSOR SETUP</i> .
	<div style="border: 1px solid black; padding: 5px; text-align: center;">                     SENSOR UPPER LIMIT                      nnnn UNITS                      SENSOR LOW LIMIT                      nnnn UNITS                 </div>	View the sensor upper and lower limits.
	<div style="border: 1px solid black; padding: 5px; text-align: center;">                     MINIMUM SPAN                      n.nn UNITS                 </div>	View the sensor minimum span.
	<div style="border: 1px solid black; padding: 5px; text-align: center;">                     SENSOR SERIAL #                       nnnnnnnn                 </div>	View the sensor serial number.

# TB82 TRANSMITTER

Key	Display	Comments
ENTER	FINAL ASSEMBLY # nnnnnnnn	View the final assembly number.
ENTER	ID TAGNAME READY	If any warnings or messages exist pertaining to this device, the terminal will list the message.

## Master Reset









Use this function to perform a transmitter reset.

Key	Display	Comments
SPECIAL FEATURE	FIX/CANCEL OUTPUT SENSOR DATA → HART SP. FEATURE	Select <i>HART SP. FEATURE</i> .
↓		
↓		
ENTER	SENSOR SETUP → MASTER RESET # RESP PREAMBLES RST CFG CHANGED	Select <i>MASTER RESET</i> . This function performs a soft reset of the TB82.
↓		
ENTER	OUTPUT WILL BE AFFECTED! PROCEED? NO → YES	Select <i>YES</i> to perform a master reset.
↓		

Key	Display	Comments
	<div style="border: 1px solid black; padding: 5px; text-align: center;">                     ID TAGNAME                       READY                 </div>	If any warnings or messages exist pertaining to this device, the terminal will list the message.









**Number of Response Preambles**

Use this function to set the number of response preambles to be sent from the device at the start of the response.

Key	Display	Comments
	<div style="border: 1px solid black; padding: 5px; text-align: center;">                     FIX/CANCEL OUTPUT                      SENSOR DATA                      → HART SP. FEATURE                 </div>	Select <i>HART SP. FEATURE</i> .
		
		
	<div style="border: 1px solid black; padding: 5px; text-align: center;">                     SENSOR DATA                      MASTER RESET                      → # RESP PREAMBLES                      RST CFG CHANGED                 </div>	Select # <i>RESP PREAMBLES</i> .
		
		
	<div style="border: 1px solid black; padding: 5px; text-align: center;">                     # RESP. PREAMBLES                       n                 </div>	Enter a number between 5 and 20. The communication device requires a certain value.  The default value is 5 response preambles.
	<div style="border: 1px solid black; padding: 5px; text-align: center;">                     ID TAGNAME                       READY                 </div>	

**Reset Configuration Change Flag**

Use this function to reset the change flag. If a change is made to a configuration a change flag is set, indicating a change to the original configuration. This function removes the change flag.

Key	Display	Comments
	<div style="border: 1px solid black; padding: 5px;">                     FIX/CANCEL OUTPUT                      SENSOR DATA                      → HART SP. FEATURES                 </div>	Select <i>HART SP. FEATURE</i> .
		
		
	<div style="border: 1px solid black; padding: 5px;">                     SENSOR DATA                      MASTER RESET                      # RESP PREAMBLES                      → RST CFG CHANGED FLG                 </div>	Select <i>RST CFG CHANGED FLG</i> to reset the change flag.
		
		
		
	<div style="border: 1px solid black; padding: 5px;">                     ID TAGNAME                       READY                 </div>	

**PROBLEM AND ERROR CODES (TB82)**

Table **N-1** lists the TB82 transmitter problem codes that can appear on the STT04 terminal. Problem codes result from fault conditions that affect the performance of the device.

Table **N-2** lists the TB82 transmitter error codes that can appear on the STT04 terminal. Error codes result from fault conditions that render the device inoperable. All codes are listed in alphabetical order.

Table N-1. Problem Codes of TB82 Transmitter

Code	Description	Corrective Action
BA.CHKS	Incorrect or missing 3-k $\Omega$ Balco temperature sensor checksum	Cycle transmitter power.
		Remove transmitter from installed location and relocate to noise-free environment. If problem does not appear, transmitter needs new final location or additional shielding on transmitter and/or wiring.
		Contact ABB.
BA.F.CAL	Out of range or missing factory calibration for 3-k $\Omega$ Balco temperature sensor	Contact ABB for factory calibration procedure. Calibrate temperature sensor for short-term usage until factory calibration can be performed.
BAD.SEE	Bad SEEPROM or pH/ORP/pION input PCB assembly	Input PCB assembly factory calibration constants can not be loaded. Calibrate sensor and order replacement pH/ORP/pION input PCB assembly. Existing assembly should properly function until new assembly is received.
BLNK.UP	Blank microprocessor EEPROM	Cycle transmitter power.
		Contact ABB.
GND LP	Ground loop present or shorted sensor cable	Verify sensor wiring connections.
		Verify sensor does not have any exposed wire from nicks, etc. If it does, repair (if possible) or replace.
		Remove any liquids, oils, scales or corrosion from transmitter terminal block or extension cable junction box terminals.
		Verify sensor responds to pH buffers. Replace sensor and/or sensor extension cable (if present) if sensor does not respond.
		Electronically test sensor (refer to the product instruction). Replace if it does not meet requirements.
HI.C.CKT	Cable diagnostic circuit failure - high range error	Verify sensor wiring connections.
		Remove any liquids, oils, scales or corrosion from transmitter terminal block or extension cable junction box terminals.
		Electronically test sensor. Replace if it does not meet requirements.
		Input PCB assembly diagnostic circuit failure exists. Disable diagnostics and order replacement input PCB assembly. Existing input PCB assembly should properly function until new assembly is received.
HI.CA.AD	Cable diagnostic signal above transmitter A/D range	Input PCB assembly diagnostic circuit failure exists. Disable diagnostics and order replacement input PCB assembly. Existing input PCB assembly should properly function until new assembly is received.
HI.EFF	High sensor efficiency (>110%)	Verify proper buffer values were used for calibration and repeat buffer calibration.
		Clean sensor and repeat buffer calibration.

*Table N-1. Problem Codes of TB82 Transmitter (continued)*

<b>Code</b>	<b>Description</b>	<b>Corrective Action</b>
HI.G.CKT	pH measuring electrode impedance circuit failure - high range error	Verify sensor wiring connections.
		Verify sensor does not have any exposed wire from nicks, etc. If it does, repair (if possible) or replace.
		Remove any liquids, oils, scales or corrosion from transmitter terminal block or extension cable junction box terminals.
		Verify sensor responds to pH buffers. Replace sensor and/or sensor extension cable (if present) if sensor does not respond.
		Electronically test sensor. Replace if it does not meet requirements.
		Input PCB assembly glass pH impedance circuit failure exists. Disable diagnostics and order replacement input PCB assembly. Existing input PCB assembly should properly function until new assembly is received.
HI.GL.DA	pH measuring electrode impedance above transmitter A/D range	Input PCB assembly glass pH impedance circuit failure exists. Disable diagnostics and order replacement input PCB assembly. Existing input PCB assembly should properly function until new assembly is received.
HI.LOOP	Current loop above upper range value (+0.4 mA hysteresis)	Verify process conditions are within configured output range. If PV is outside configured range, increase output range.
		Verify sensor wiring connections.
		Remove any liquids, oils, scales or corrosion from transmitter terminal block or extension cable junction box terminals.
		Clean sensor and perform a buffer and process calibration.
		Conduct a temperature calibration. If not using temperature sensor, verify configuration for TMP.SNS is NONE.
		Electronically test the sensor and temperature compensator (refer to the product instruction). Replace sensor if it does not meet requirements.
+HI.OFF	Large positive sensor offset (>180 mV)	Clean sensor and perform buffer and process calibration.
		Inspect sensor and cabling for shorts. Remove all potential shorts to ground, conduit or metals.
		If sensor is functioning properly, order spare sensor to replace existing sensor. Replace existing sensor with spare when transmitter does not accept calibration values.
-HI.OFF	Large negative sensor offset (<-180 mV)	Clean sensor and perform buffer and process calibration.
		Inspect sensor and cabling for shorts. Remove all potential shorts to ground, conduit or metals.
		If sensor is functioning properly, order spare sensor to replace existing sensor. Replace existing sensor with spare when transmitter does not accept calibration values.



*Table N-1. Problem Codes of TB82 Transmitter (continued)*

<b>Code</b>	<b>Description</b>	<b>Corrective Action</b>
HI.PV	PV above transmitter range	Verify process conditions are within transmitter range. PV must be within transmitter range.
		Verify sensor wiring connections.
		Verify sensor does not have any exposed wire from nicks, etc. If it does, repair (if possible) or replace.
		Remove any liquids, oils, scales or corrosion from transmitter terminal block or extension cable junction box terminals.
		Verify sensor responds to pH buffers. Replace sensor and/or sensor extension cable (if present) if sensor does not respond.
		Electronically test sensor (refer to the product instruction). Replace if it does not meet requirements.
HI.R.CKT	Reference impedance circuit failure - high range error	Verify sensor wiring connections.
		Verify reference is clean. Remove any foreign material.
		Clean sensor and verify it responds to pH buffer. Replace sensor if it does not respond.
		Change configuration to increase reference impedance limit if sensor is functioning properly in buffers and is in final installed location.
		Input PCB reference impedance circuit failure exists. Disable diagnostics and order replacement input PCB assembly. Existing input PCB assembly should properly function until new assembly is received.
HI.REF.Z	High reference electrode impedance	Verify sensor wiring connections.
		Verify reference is clean. Remove any foreign material.
		Clean sensor and verify it responds to pH buffer. Replace sensor if it does not respond.
		Change configuration to increase reference impedance limit if sensor is functioning properly in buffers and is in final installed location.
HI.RZ.AD	Reference impedance above transmitter A/D range	Input PCB reference impedance circuit failure exists. Disable diagnostics and order replacement input PCB assembly. Existing input PCB assembly should properly function until new assembly is received.
HI.T.AD	Open or missing temperature sensor	Verify process conditions are within transmitter range. PV must be within transmitter range.
		Verify process conditions are within configured output range. If PV is outside configured range, increase output range.
		Verify sensor wiring connections.
		Remove any liquids, oils, scales or corrosion from transmitter terminal block or extension cable junction box terminals.
		Clean sensor and perform a buffer and process calibration.
		Conduct temperature calibration. If not using temperature sensor, verify configuration for TMP.SNS is NONE.
		Electronically test sensor and temperature compensator (refer to the product instruction). Replace sensor if it does not meet requirements.
		Replace pH/ORP/pION input PCB assembly.

*Table N-1. Problem Codes of TB82 Transmitter (continued)*

<b>Code</b>	<b>Description</b>	<b>Corrective Action</b>
HI.TEMP	Temperature above transmitter range	Verify process conditions are within transmitter range. PV must be within transmitter range.
		Verify process conditions are within configured output range. If PV is outside configured range, increase output range.
		Verify sensor wiring connections.
		Remove any liquids, oils, scales or corrosion from transmitter terminal block or extension cable junction box terminals.
		Clean sensor and perform a buffer and process calibration.
		Conduct a temperature calibration. If not using temperature sensor, verify configuration for TMP.SNS is NONE.
		Electronically test the sensor and temperature compensator (refer to the product instruction). Replace sensor if it does not meet requirements.
LO.C.CKT	Cable diagnostic circuit failure - low range error	Verify sensor wiring connections.
		Remove any liquids, oils, scales or corrosion from transmitter terminal block or extension cable junction box terminals.
		Electronically test sensor. Replace if it does not meet requirements.
		Input PCB assembly diagnostic circuit failure exists. Disable diagnostics and order replacement input PCB assembly. Existing input PCB assembly should properly function until new assembly is received.
LO.CA.AD	Cable diagnostic signal below transmitter A/D range	Input PCB assembly diagnostic circuit failure exists. Disable diagnostics and order replacement input PCB assembly. Existing input PCB assembly should properly function until new assembly is received.
LO.EFF	Low sensor efficiency (<60%)	Verify proper buffer values were used for calibration and repeat buffer calibration.
		Clean sensor and repeat buffer calibration.
		Look for shorts in sensor and extension cable. Remove all potential shorts. Remove any liquids, oils, scales or corrosion from transmitter terminal block or junction box terminals.
		If sensor is functioning properly, order new sensor to replace existing sensor once transmitter does not accept calibration values.
LO.G.CKT	pH measuring electrode impedance circuit failure - low range error	Verify sensor wiring connections.
		Verify glass electrode is intact. If broken, replace sensor.
		Remove any liquids, oils, scales or corrosion from transmitter terminal block or extension cable junction box terminals.
		Verify sensor responds to pH buffers. Replace sensor if it does not respond.
		Change configuration to proper analyzer type if sensor is not a glass pH sensor.
		Input PCB assembly glass pH impedance circuit failure exists. Disable diagnostics and order replacement input PCB assembly. Existing input PCB assembly should properly function until new assembly is received.

*Table N-1. Problem Codes of TB82 Transmitter (continued)*

<b>Code</b>	<b>Description</b>	<b>Corrective Action</b>
LO.GL.AD	pH measuring electrode impedance below transmitter A/D range	Input PCB assembly glass pH impedance circuit failure exists. Disable diagnostics and order replacement input PCB assembly. Existing input PCB assembly should properly function until new assembly is received.
LO.GLS.Z	Low pH measuring electrode impedance	Verify sensor wiring connections.
		Verify glass electrode is intact. If broken, replace sensor.
		Remove any liquids, oils, scales or corrosion from transmitter terminal block or extension cable junction box terminals.
		Verify sensor responds to pH buffers. Replace sensor if it does not respond.
		Change configuration to proper analyzer type if sensor is not a glass pH sensor.
LO.LOOP	Current loop below lower range value (-0.2 mA hysteresis)	Verify process conditions are within configured output range. If PV is outside configured range, increase output range.
		Verify sensor wiring connections.
		Remove any liquids, oils, scales or corrosion from transmitter terminal block or extension cable junction box terminals.
		Clean sensor and perform a buffer and process calibration.
		Conduct a temperature calibration. If not using temperature sensor, verify configuration for TMP.SNS is NONE.
		Electronically test the sensor and temperature compensator (refer to the product instruction). Replace sensor if it does not meet requirements.
LO.PV	PV below transmitter range	Verify process conditions are within transmitter range. PV must be within transmitter range.
		Verify sensor wiring connections.
		Verify sensor does not have any exposed wire from nicks, etc. If it does, repair (if possible) or replace.
		Remove any liquids, oils, scales or corrosion from transmitter terminal block or extension cable junction box terminals.
		Verify sensor responds to pH buffers. Replace sensor and/or sensor extension cable (if present) if sensor does not respond.
		Electronically test sensor (refer to the product instruction). Replace if it does not meet requirements.
LO.R.CKT	Reference impedance circuit failure - low range error	Verify sensor wiring connections.
		Electronically test sensor. Replace if it does not meet requirements.
		Input PCB reference impedance circuit failure exists. Disable diagnostics and order replacement input PCB assembly. Existing input PCB assembly should properly function until new assembly is received.
LO.RZ.AD	Reference impedance below transmitter A/D range	Input PCB reference impedance circuit failure exists. Disable diagnostics and order replacement input PCB assembly. Existing input PCB assembly should properly function until new assembly is received.

*Table N-1. Problem Codes of TB82 Transmitter (continued)*

<b>Code</b>	<b>Description</b>	<b>Corrective Action</b>
LO.T.AD	Shorted temperature sensor	Verify process conditions are within transmitter range. PV must be within transmitter range.
		Verify process conditions are within configured output range. If PV is outside configured range, increase output range.
		Verify sensor wiring connections.
		Remove any liquids, oils, scales or corrosion from transmitter terminal block or extension cable junction box terminals.
		Clean sensor and perform buffer and process calibration.
		Conduct temperature calibration. If not using temperature sensor, verify configuration for TMP.SNS is NONE.
		Electronically test sensor and temperature compensator (refer to the product instruction). Replace sensor if it does not meet requirements.
		Replace pH/ORP/pION input PCB assembly.
LO.TEMP	Temperature below transmitter range	Verify process conditions are within transmitter range. PV must be within transmitter range.
		Verify process conditions are within configured output range. If PV is outside configured range, increase output range.
		Verify sensor wiring connections.
		Remove any liquids, oils, scales or corrosion from transmitter terminal block or extension cable junction box terminals.
		Clean sensor and perform a buffer and process calibration.
		Conduct a temperature calibration. If not using temperature sensor, verify configuration for TMP.SNS is NONE.
		Electronically test sensor and temperature compensator (refer to the product instruction). Replace sensor if it does not meet requirements.
NO.F.CAL	Missing factory calibration and functional SEEPROM	Contact ABB for factory calibration procedure. Calibrate sensor for short-term usage until factory calibration can be performed.
OPEN	Open sensor cable or sensor out of solution	Verify sensor wiring connections.
		Verify sensor does not have any exposed wire from nicks, etc. If it does, repair (if possible) or replace.
		Remove any liquids, oils, scales or corrosion from transmitter terminal block or extension cable junction box terminals.
		Verify sensor responds to pH buffers. Replace sensor and/or sensor extension cable (if present) if sensor does not respond.
		Electronically test sensor (refer to the product instruction). Replace if it does not meet requirements.
PV.CHKS	Incorrect or missing PV checksum	Cycle transmitter power.
		Remove transmitter from installed location and relocate to noise-free environment. If problem does not appear, transmitter needs new final location or additional shielding on transmitter and/or wiring.
		Contact ABB.

*Table N-1. Problem Codes of TB82 Transmitter (continued)*

<b>Code</b>	<b>Description</b>	<b>Corrective Action</b>
PT.CHKS	Incorrect or missing Pt 100 temperature sensor checksum	Cycle transmitter power.
		Remove transmitter from installed location and relocate to noise-free environment. If problem does not appear, transmitter needs new final location or additional shielding on transmitter and/or wiring.
		Contact ABB.
PT.F.CAL	Out of range or missing factory calibration for Pt 100 temperature sensor	Contact ABB for factory calibration procedure. Calibrate temperature sensor for short-term usage until factory calibration can be performed.
PZ.CHKS	Incorrect or missing reference impedance measurement checksum	Cycle transmitter power.
		Remove transmitter from installed location and relocate to noise-free environment. If problem does not appear, transmitter needs new final location or additional shielding on transmitter and/or wiring.
		Contact ABB.
PV.F.CAL	Out of range or missing factory calibration for PV	Contact ABB for factory calibration procedure. Calibrate sensor for short-term usage until factory calibration can be performed.
ROM.EMI	Unverifiable EEPROM/ROM bus read operation	Cycle transmitter power.
		Contact ABB.
ROM.SUM	Incorrect EPROM checksum	Cycle transmitter power.
		Contact ABB.
RZ.F.CAL	Out of range or missing factory calibration for reference impedance measurement	Contact ABB for factory calibration procedure. Reference impedance diagnostic will not be operational until factory calibration is performed. Disable diagnostics until factory calibration can be performed.
SEE.EMI	Unverifiable SEEPROM bus read operation	Cycle transmitter power.
		Contact ABB.

*Table N-2. Error Codes of the TB82 Transmitter*

<b>Code</b>	<b>Description</b>
FC.PCB	4 wire conductivity board with pH/ORP/pION firmware.
HI.PV.AD	Overrange PV A/D.
LO.PV.AD	Underrange PV A/D.
TC.PCB	Toroidal conductivity board with PH/ORP/pION firmware.

---

# APPENDIX O - STT04 DOWNLINK SOFTWARE

---

## INTRODUCTION

This appendix covers the functions of the STT04 DownLink software. The software is used in conjunction with the STT04 terminal. DownLink software features include:

- PC to STT04 interface.
- STT04 firmware upgrades via the internet.
- Upload and download device configurations from PC.
- Create configuration databases on PC.

The software is provided on a CD and is shipped with the STT04 terminal. Software installation is detailed in [Section 3](#).

**NOTE:** If you do not have DownLink software, contact the nearest ABB sales office for availability.

---

## SECURITY

An assigned user name and password are required to access DownLink software. The administrator can choose to bypass the password feature of DownLink software. User names and passwords are assigned with the Password program. Access to the Password program requires the Password Key disk. Only personnel at the highest security level should have access to the Password Key disk in order to ensure security.

---

### *Starting the Password Program*

After installing the software, the password program should be setup in order to access the features of DownLink software.

1. Click *Start* and select *Programs*.
2. Highlight *ABB* and select *Password*.

---

### *Adding a User*

Use this function to add a user to the STT04 DownLink software.

1. Start the Password program. Refer to [Starting the Password Program](#).
2. Insert the Password Key disk into a floppy disk drive.
3. Click *Key* and type the appropriate disk drive letter (i.e., A:) and click *Verify*. The screen shown in [Figure O-1](#) appears.

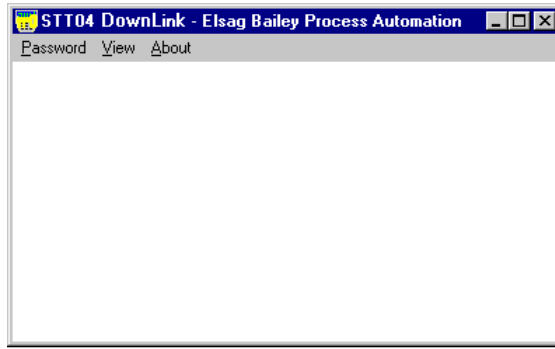

TC00654B

Figure O-1. Password Key Screen

4. Click *Password* and select *Add*. The screen shown in Figure O-2 appears.

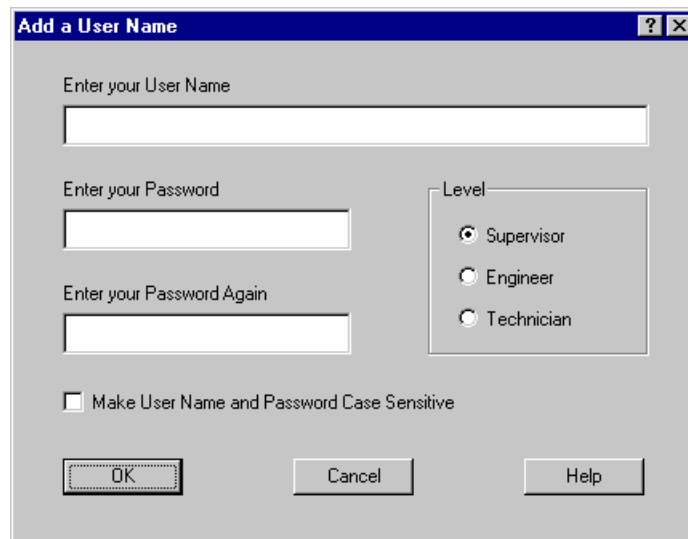

TC00655B

Figure O-2. Add User Dialog Box

5. Click in *Enter your User Name* and type a user name of at least three and up to 32 characters.
6. Click in *Enter your Password* and type a unique password of at least three and up to 24 characters. The characters typed show as asterisks (\*) for security reasons.
7. Click in *Enter your Password Again* and type the password again.
8. Select a security level by clicking the appropriate level. Refer to Table O-1 for level descriptions.

Table O-1. User Level Accessibility

Menu Item	Operation	Access Level		
		Supervisor	Engineer	Technician
Database	New	X	X	
	Open	X	X	X
	Exit	X	X	X
View Configurations	Connected STT04	X	X	X
	Database files	X	X	X
Transfer Configurations	Upload from STT04	X	X	
	Download to STT04	X	X	
Utilities	Test Communication	X	X	X
	Change STT04 Name	X	X	
Special Advanced	Report diagnostics	X	X	X
	Upgrade firmware	X		
	Upgrade boot code	X		
	Set COM Port	X	X	X

9. To set user name and password to be case sensitive, click *Make User Name and Password Case Sensitive*.

**NOTE:** Case sensitivity provides added security, however it can become a nuisance to the entry process. In addition to remembering the user name and password, the user must also remember whether they are all lower case, all upper case, initial capitals, or some other variation. It is recommended that this box be left unchecked to avoid unnecessary confusion.

10. Click *OK*.

11. Remove the Password Key disk and store in a safe and secure location with limited access. Only *Supervisor* security level personnel should have access to the Password Key disk.

---

### ***Deleting a User***

Use this function to delete a user name.

1. Start the Password program. Refer to ***Starting the Password Program***.
2. Insert the Password Key disk into the appropriate floppy disk drive.
3. Click *Key* and type the appropriate floppy disk drive letter (i.e., A:) and click *Verify*. The screen shown in Figure O-1 appears.
4. Click *Password* and select *Delete*. A list of user names appears.
5. Select the user name to remove and click *Delete*.



6. Remove the Password Key disk and store in a safe and secure location with limited access. Only *Supervisor* security level personnel should have access to the Password Key disk.

---

### **Bypass**

Use this function to bypass the security feature. When *Bypass* is selected no password is required to access any or all of the functionality of DownLink software including overwriting, editing and deleting configurations.

---

#### ***Disable Password Security***

1. Start the Password program. Refer to ***Starting the Password Program***.
2. Insert the Password Key disk into the appropriate floppy disk drive.
3. Click *Key* and type the appropriate floppy disk drive letter (i.e., A:) and click *Verify*. The screen shown in Figure O-1 appears.
4. Click *Password* and select *Bypass*. A message appears warning of the significance of bypassing security.
5. Click *Yes* to bypass security.

---

#### ***Enable Password Security***

1. Start the Password program. Refer to ***Starting the Password Program***.
2. Insert the Password Key disk into the appropriate floppy disk drive.
3. Click *Key* and type the appropriate floppy disk drive letter (i.e., A:) and click *Verify*. The screen shown in Figure O-1 appears.
4. Click *Password* and select *Delete*.
5. Select *PASSWORD BYPASS* and click *Delete*.
6. Remove the Password Key disk and store in a safe and secure location with limited access. Only *Supervisor* security level personnel should have access to the Password Key disk.

---

### **View User Names**

Use this function to view a list of user names.

1. Start the Password program. Refer to ***Starting the Password Program***.

2. Insert the Password Key disk into the appropriate floppy disk drive.
3. Click *Key* and type the appropriate floppy disk drive letter (i.e., A:) and click *Verify*. The screen shown in Figure O-1 appears.
4. Click *View* and a list of user names appears.
5. Click *Cancel* when finished.
6. Remove the Password Key disk and store in a safe and secure location. Only *Supervisor* security level personnel should have access to the Password Key disk.

**USING DOWNLINK SOFTWARE**

This section provides steps for each menu function of DownLink software. Table O-2 summarizes the software functions.

*Table O-2. Software Function Summary*

Main Menu Functions	Selections	Descriptions
Database	New	Creates a new database folder on the PC.
	Open	Opens an existing database folder and it becomes the current database.
	Exit	Closes the application.
View Configurations	Connected STT04	Shows a list of configurations in the connected STT04.
	Database files	Shows a list of configuration files in the current database.
Transfer Configurations	Upload from STT04	Transfers configuration files from a connected STT04 to a database file folder on the PC.
	Download to STT04	Copies configurations files from a PC database folder to a connected STT04.
Utilities	Test Communication	Tests communications connection between the PC and the connected STT04.
	Change STT04 name	Changes the name of the connected STT04 terminal.
Special Advanced	Report diagnostics	Reports general information about the connected STT04.
	Upgrade firmware	Upgrades firmware of the STT04.
	Upgrade boot code	Use this only when instructed by ABB technical support.
	Set COM port	Use to select the communication port on the PC that will be used to interface an STT04.

### Start

To start DownLink software:

1. Click *Start*, select *Programs* and choose the *ABB* program group.
2. Double click the STT04 icon.
3. Click *Password*. A password dialog box appears.
4. Type your user name and password and click *OK*. The DownLink software application opens (Fig. O-3).

#### NOTES:

1. Remember user names and passwords can be case sensitive.
2. Select the desired COM port the first time the software is started by clicking *Special Advanced* and selecting *Set COM Port*.

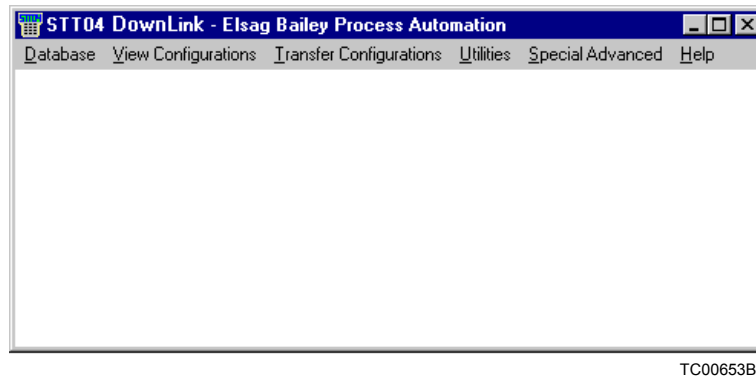

Figure O-3. Utilities Software Screen

### Database

Each database relates to a file folder on the computer. The following subsections describe the menu items of the *Database* selection.

#### NEW

Use this function to create a database folder on the personal computer for configuration storage. New databases are normally saved under the following path:

*C:\Program Files\STT04 DownLink - ABB Process Automation\Database\[database name]*

1. Start the DownLink software. Refer to **Start** located in this section.
2. Click *Database* and select *New*.

3. Click in the field and type a database name.
4. Click *Add* to create the database. A message box appears indicating that the database was created.
5. Click *OK*.

---

***OPEN***

Use this function to open an existing database folder. The open database becomes the current database.

1. Start the DownLink software. Refer to **Start** located in this section.
2. Click *Database* and select *Open*.
3. Select the desired database name and click *Select*. A message box appears indicating that the database was opened.
4. Click *OK*.

---

***EXIT***

Use this function to close the application.

Click *Database* and select *Exit*.

**- or -**

Click the X on the top right corner of the main application window.

---

***View Configurations***

The following subsections describe the menu items of the *View Configurations* selection.

---

***CONNECTED STT04***

Use this function to view the configurations that are stored in a connected STT04 terminal.

1. Connect the STT04 terminal to the personal computer.
  - a. Connect the female end of the RS-232-C cable to a vacant RS-232-C port (serial port) on the personal computer.
  - b. Connect the male end of the RS-232-C cable to the STT04 terminal.
2. Start the DownLink software. Refer to **Start** located in this section.

3. Place the STT04 terminal into the remote mode. Refer to **UPLOADING AND DOWNLOADING CONFIGURATIONS** in Section 4 for details.
4. Click *View Configurations* and select *Connected STT04 terminal*. A list of configurations appears.
5. Click *Cancel* after viewing.

---

### **DATABASE FILES**

Use this function to view the configuration files of the current database.

1. Start the DownLink software. Refer to **Start** located in this section.
2. Select a database.
  - a. Click *Database* and select *Open*.
  - b. Select the desired database name and click *Select*. A message box appears indicating that the database was opened.
  - c. Click *OK*.
3. Click *View Configurations* and select *Database files*. A list of configurations appears.
4. Click *Cancel* after viewing.

**NOTE:** Configuration files (i.e., config01.CFG) may be moved and copied between database folders using a file manager such as Windows Explorer.

---

### **Transfer Configurations**

The following subsections describe the menu items of the *Transfer Configurations* selection.

## UPLOAD FROM STT04

Use this function to load configuration files from a connected STT04 terminal to the personal computer.

1. Connect the STT04 terminal to the personal computer.
  - a. Connect the female end of the RS-232-C cable to a vacant RS-232-C port (serial port) on the personal computer.
  - b. Connect the male end of the RS-232-C cable to the STT04 terminal.
2. Start the DownLink software. Refer to **Start** located in this section.
3. Place the STT04 terminal into the remote mode. Refer to **UPLOADING AND DOWNLOADING CONFIGURATIONS** in Section 4 for details.
4. Click *Transfer Configurations* and select *Upload from STT04*. A summary of configurations appears (Fig O-4).

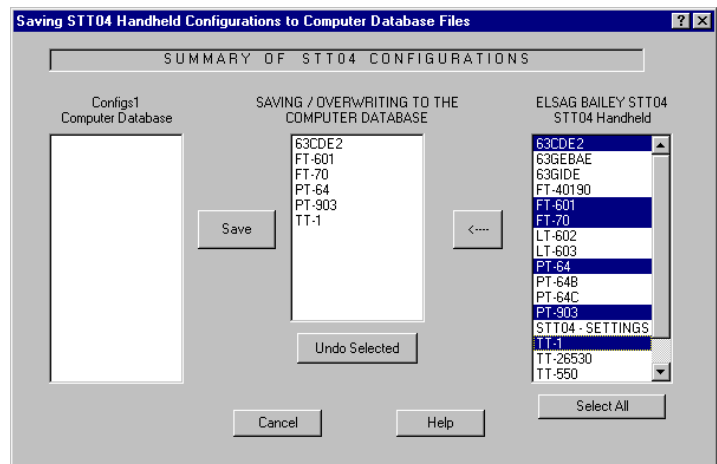

TC00966A

Figure O-4. Summary of STT04 Configurations

5. Highlight the desired configurations from the STT04 terminal.
 

Click to select only the configurations you want. Do this until all the desired configurations are selected.

**- or -**

Click *Select All* to upload all configuration from the STT04 terminal (Fig O-4).

**NOTE:** If a configuration already exists, DownLink software prompts to replace the existing configuration and indicates if it has changed in the field (Fig. O-5).

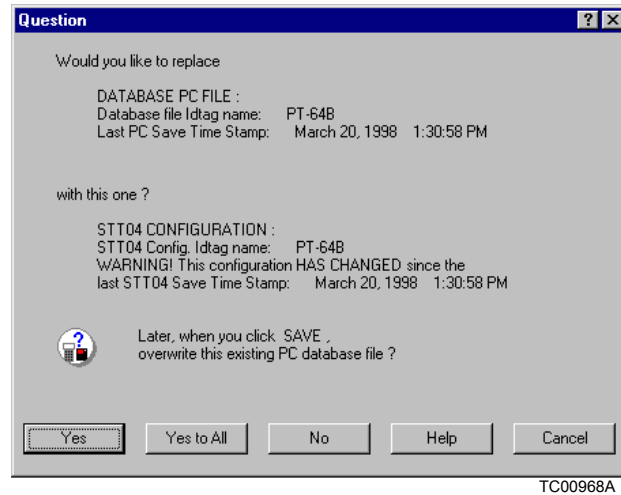

Figure O-5. Replace Configuration File Dialog

6. Click the arrow key to identify the configurations for transfer (Fig O-4).
7. Make certain that the desired database has been selected. For details refer to **OPEN**, located in this section.
8. Click Save (Fig O-4). The selected configurations will be saved to the database on the personal computer.

---

### **DOWNLOAD TO STT04**

Use this function to download configurations from the personal computer to the STT04 terminal.

1. Connect the STT04 terminal to the personal computer.
  - a. Connect the female end of the RS-232-C (customer supplied) cable to a vacant RS-232-C port (serial port) on the personal computer.
  - b. Connect the male end of the RS-232-C cable to the STT04 terminal.
2. Start the DownLink software program. Refer to **Start** located in this section.

3. Place the STT04 terminal into the remote mode. Refer to **UPLOADING AND DOWNLOADING CONFIGURATIONS** in Section 4 for details.

4. Click *Transfer Configurations* and select *Download to STT04*. A summary of configurations appears similar to the screen in Figure O-4.

5. Highlight the desired configurations from the computer database.

Click to select only the configurations you want. Do this until all the desired configurations are selected.

**- or -**

Click *Select All* to select all configurations from in the computer database (Fig O-4).

**NOTE:** If a configuration already exists, DownLink software prompts to replace the existing configuration and indicates if it has changed in the field (Fig. O-5).

6. Click the arrow key to identify the configuration(s) for transfer (Fig O-4).

**NOTE:** The select box (in the center of the screen) holds the configurations that will be transferred to the STT04 terminal.

7. Click *Transfer*. The selected configurations are downloaded to the STT04 terminal.

---

### **Utilities**

The following subsections describe the menu items of the *Utilities* selection.

---

#### **TEST COMMUNICATION**

Use this function to verify communications and the physical connection between the STT04 terminal and the personal computer.

1. Connect the STT04 terminal to the personal computer.

a. Connect the female end of the RS-232-C cable to a vacant RS-232-C port (serial port) on the personal computer.

b. Connect the male end of the RS-232-C cable to the STT04 terminal.

2. Start the DownLink software. Refer to **Start** located in this section.



3. Click *Utilities* and select *Test Communication*. A message appears indicating the status of communications.

4. Click *OK* to exit the test function.

**Failed Test** If the communications test fails, verify the following before calling ABB technical support:

- Make sure the cable is completely connected to the STT04 terminal and the PC.
- Make certain the cable is connected to the correct port on the PC. Verify the COM port setting using *Special Advanced* and select *Set COM port*.
- Make certain the cable is not faulty. Connect a cable known to be functional.
- Make sure the STT04 terminal is in remote mode. Refer to **UPLOADING AND DOWNLOADING CONFIGURATIONS** in Section 4 for details.
- Make sure the STT04 terminal has at least 50-percent battery charge remaining. If it does not, connect and plug in the battery charger.

---

### **CHANGE STT04 NAME**

The STT04 terminal is shipped from the factory with the following name: *ABB STT04*. It is good practice to change the name of an STT04 terminal when multiple terminals are in use that have different configurations. Renaming helps to prevent overwriting the configurations of another terminal. Good practice for database management is to dedicate a database folder to a specific STT04 terminal.

1. Connect the STT04 terminal to the personal computer.
  - a. Connect the female end of the RS-232-C (customer supplied) cable to a vacant RS-232-C port (serial port) on the personal computer.
  - b. Connect the male end of the RS-232-C cable to the STT04 terminal.
2. Start the DownLink software. Refer to **Start** located in this section.
3. Click *Utilities* and select *Change STT04 Name*.
4. Click in the *STT04 Name* field.
5. Type an STT04 name using up to 18 characters.

6. Click *OK*.

---

***Special Advanced***

The following subsections describe the menu items of the *Special Advanced* selection.

---

***REPORT DIAGNOSTICS***

1. Connect the STT04 terminal to the personal computer.
  - a. Connect the female end of the RS-232-C (customer supplied) cable to a vacant RS-232-C port (serial port) on the personal computer.
  - b. Connect the male end of the RS-232-C cable to the STT04 terminal.
2. Start the DownLink software. Refer to **Start** located in this section.
3. Click *Special Advanced* and select *Report Diagnostics*. This function returns the COM port being used, sector status and available sector status of the STT04 terminal.

---

***UPGRADE FIRMWARE***

Refer to **UPGRADES** in Section 6.

---

***UPGRADE BOOT CODE***

This function is seldom needed and should only be performed when instructed to do so by ABB technical support.

---

***SET COM PORT***

Use this function to change the communication port (COM port) on the personal computer that will be used for communications between the PC and the STT04 terminal.

1. Start the DownLink software. Refer to **Start** located in this section.
2. Click *Special Advanced* and select *Set COM Port*.
3. Select the desired communication port and click *OK*.

# APPENDIX P - AS800 PRESSURE TRANSMITTER

## INTRODUCTION

This appendix covers the configuration and calibration functions of the AS800 Pressure Transmitter.

Refer to **OPERATING PROCEDURES** in Section 4 for information on the following functions:

- Send configurations.
- Get configurations.
- View configurations.
- Select configurations.
- Erase configurations.
- Operational functions.

**NOTE:** To change calibration or configuration parameters of a smart field device that is connected to an IMFBS01 module, the device must be taken off-line. This is done at the INFI 90 OPEN console.

## CREATE/MODIFY CONFIGURATION

A configuration can be created off-line, without a connected field device. Refer to Figure P-1 for an overview of the configuration function. The following table details the configuration process.

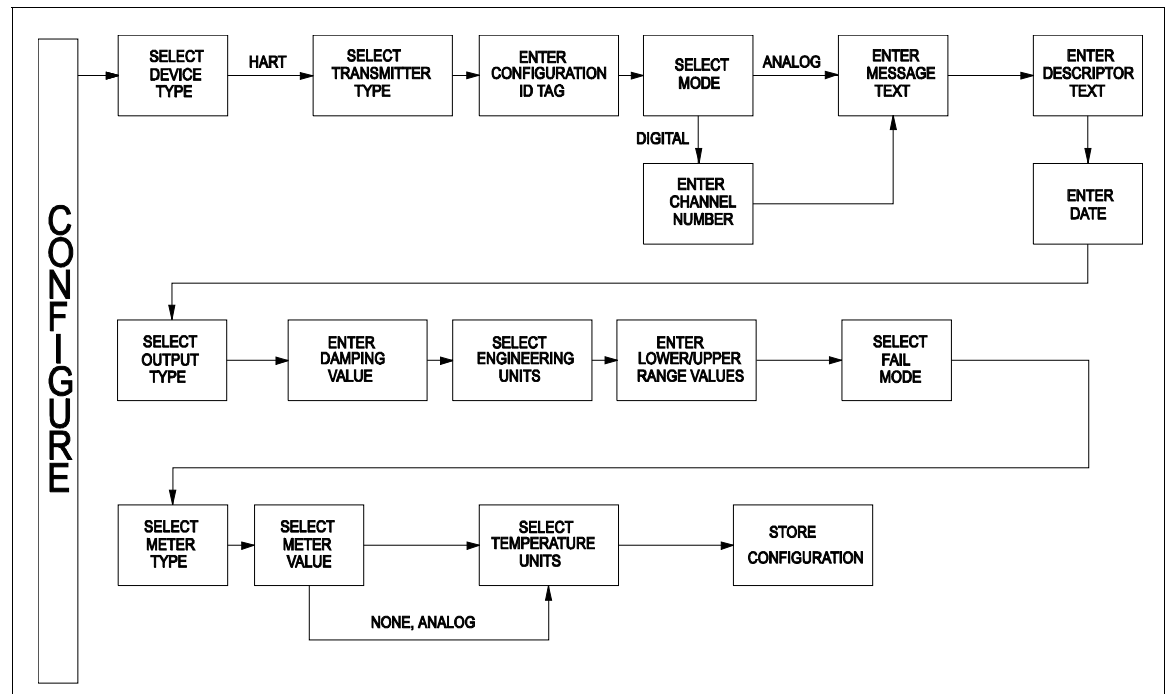

Figure P-1. Configuration Flowchart (AS800)

The STT04 does not support configuration of the AS800 transfer function or controller function.



Key	Display	Comments
ENTER	MESSAGE: ←PREVIOUS    NEXT→	Type a descriptive message using up to 32 characters. This field can be used to note anything of importance to the device or installation.  To select a character, press the key that has the desired character. Continue to press the key until the desired character appears. Use the right arrow key to move to the next character. Use the left arrow key to go back to the previous character.
ENTER	DESCRIPTOR: ←PREVIOUS    NEXT→	Type a descriptor string using up to 16 characters. This field can be used for notations about the device or process.  To select a character, press the key that has the desired character. Continue to press the key until the desired character appears. Use the right arrow key to move to the next character. Use the left arrow key to go back to the previous character.
ENTER	DATE: DAY: nn MONTH: nn YEAR: nn	Enter a day and press <b>ENTER</b> . Enter a month and press <b>ENTER</b> . Enter a year and press <b>ENTER</b> .  This date can represent the creation date of the configuration, the date the device or element was installed, or some other significant date.
ENTER	OUTPUT TYPE → LINEAR SQUARE ROOT FUNC GENERATOR 3/2 FLOW MODE	Select <i>LINEAR</i> .  <b>NOTE:</b> Other output type selections are <i>SQUARE ROOT</i> , <i>FUNC GENERATOR</i> and <i>3/2 FLOW MODE</i> .  <b>NOTE:</b> IBIS software is needed to configure <i>FUNC GENERATOR</i> breakpoints.
ENTER	DAMPING: (0 - 60 SEC)  0.5 SECS	Use <b>BACK</b> to return to a previous configuration screen from any screen in the configuration process.  Enter a value between 0 and 60 seconds.
ENTER	ENGINEERING UNIT → iH2O            iHg ftH2O            mmH2O mmHg            PSI	Select an engineering unit best suited for the application. Other units not shown include <i>BARS</i> , <i>mBAR</i> , <i>gSqCm</i> , <i>KgCm2</i> , <i>Pa</i> , <i>KPa</i> , <i>torr</i> and <i>ATM</i> .
ENTER	LOWER RANGE VAL nn.nn UNITS UPPER RANGE VAL nn.nn UNITS	Input lower range value using the arrow keys, then press <b>ENTER</b> . Input the upper range value, then press <b>ENTER</b> .

# AS800 PRESSURE TRANSMITTER

Key	Display	Comments
ENTER	FAIL MODE: → LOW HIGH	Refer to the <i>AS800 Pressure Transmitter</i> instruction for mode description.
ENTER	METER TYPE: → ALPHANUMERIC ANALOG NONE	Select the AS800 <i>METER TYPE</i> . Selecting NONE or ANALOG will cause the configuration to proceed to <i>TEMPERATURE UNITS</i> . Selecting ALPHANUMERIC will proceed to the <i>METER VALUE</i> selection.
ENTER	METER VALUE → PRIMARY E.U. % OUTPUT PV % and EU TV PV CURRENT TEMPERATURE 3 1/2 DIGIT	Select LCD meter display variable. Use down arrow key to select, then press <b>ENTER</b> .
ENTER	TEMPERATURE UNITS → °C °F °R °K	Select the AS800 <i>TEMPERATURE UNITS</i> . Use arrow key to select option, then press <b>ENTER</b> .
ENTER	STORE THIS CONFIGURATION? NO → YES	Select YES.
↓		
ENTER	ID TAGNAME READY	

**CALIBRATION**

This section details the AS800 pressure transmitter calibration functions using an STT04 terminal. There are four types of calibration functions:

- Input A/D
- D-to-A adjust (Analog Mode only)
- Zero Trim
- Temperature

**NOTES:**

1. When calibrating, a field device must be connected to the STT04 terminal.
2. To change calibration or configuration parameters of a field device that is connected to an IMFBS01 module, the transmitter must be taken off-line. This is done at the INFI 90 OPEN console.

Refer to Figure P-2 for an overview of the calibration functions.

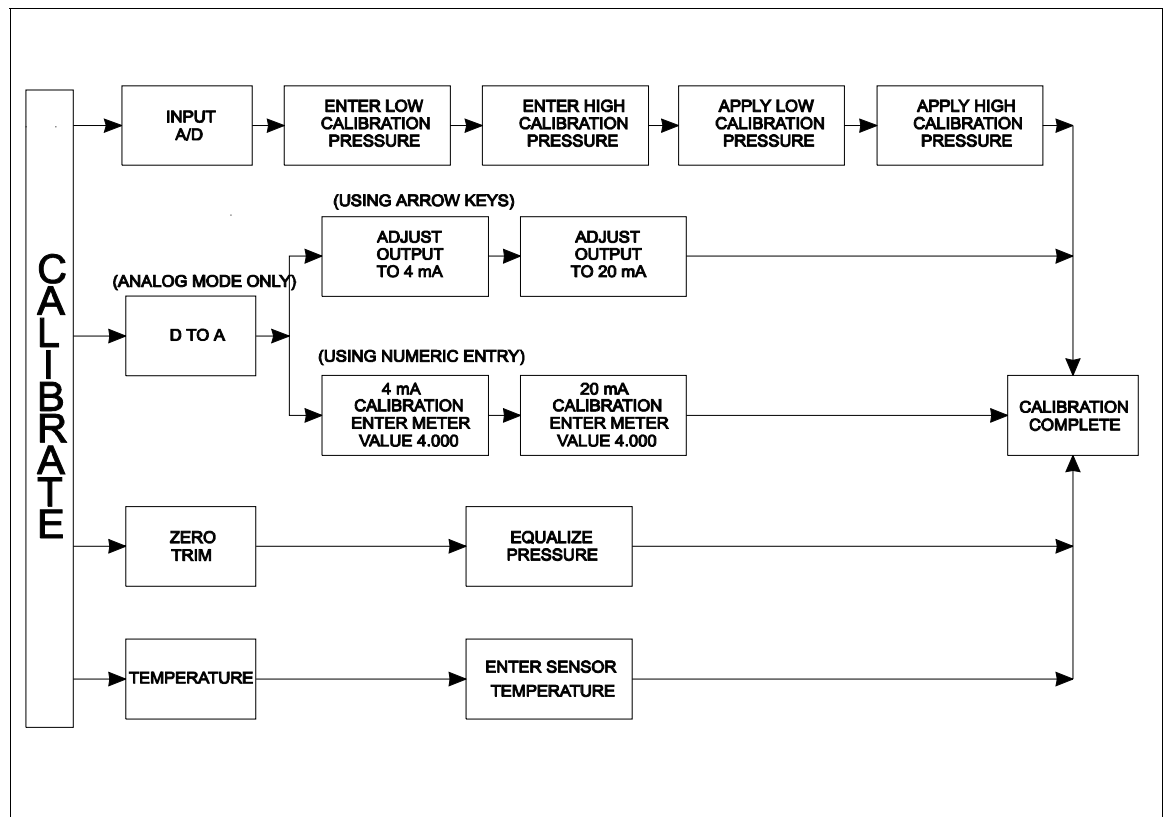

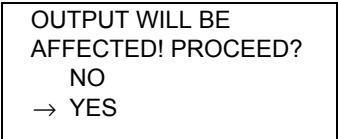

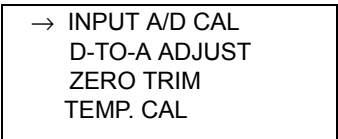

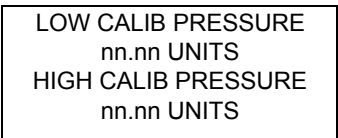

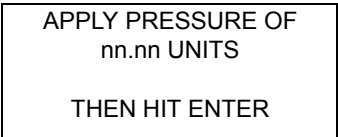

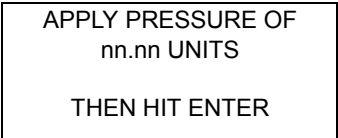

Figure P-2. Calibration Flowchart (AS800)

# AS800 PRESSURE TRANSMITTER

## Input A/D

This procedure applies to AS800 pressure transmitters configured for either *ANALOG* or *DIGITAL*. Any differences between the two are noted in the **Comments** column.

Key	Display	Comments
		<p>This operation will cause a change in output not corresponding to the input. Be sure the control loop is in manual.</p> <p>Select <b>YES</b>.</p>
		
		<p>Select <i>INPUT A/D CAL.</i>, or select calibration option with down-arrow key. Press <b>ENTER</b> when done.</p>
		<p>Enter the low calibration pressure value and press <b>ENTER</b>. Enter the high calibration pressure value, then press <b>ENTER</b>.</p>
		<p>Apply the low calibration pressure to the input of transmitter as specified earlier.</p>
		<p>Apply the high calibration pressure to the input of transmitter as specified earlier.</p>









**D-to-A Adjust**



The *D-TO-A ADJUST* selection is only present when you are in the *ANALOG* communication mode. There are two methods available to adjust the four to 20 milliampere output:

- Arrow key.
- Meter value entry for HART devices.

**ARROW KEY ADJUSTMENT**





Use this function to adjust the 4 to 20 milliampere output of the field device using the up and down arrow keys.



Key	Display	Comments
 	<div style="border: 1px solid black; padding: 5px;">                     OUTPUT WILL BE AFFECTED! PROCEED?                      NO                      → YES                 </div>	This operation will cause a change in output not corresponding to the input. Be sure the control loop is in manual. Select <i>YES</i> .
	<div style="border: 1px solid black; padding: 5px;">                     CALIBRATION                      → D-TO-A ADJUST                      BENCH CALIB.                 </div>	Select <i>D-TO-A ADJUST</i> .
 	<div style="border: 1px solid black; padding: 5px;">                     D/A CAL USING                      →UPDOWN ARROW KEYS                      METER VALUE ENTRY                 </div>	Select <i>UPDOWN ARROW KEYS</i> .
	<div style="border: 1px solid black; padding: 5px;">                     ADJUST TO 4 mA                       THEN HIT ENTER                 </div>	Use the arrow keys to adjust the 4 mA signal.  <b>NOTE:</b> When increasing or decreasing the mA signal, the increments of change increase with successive depressions until the maximum level of change is reached. By changing direction you will return to the smallest increment of change. This adjustment technique speeds up the adjustment process without affecting fine adjustment.

Key	Display	Comments
	<div style="border: 1px solid black; padding: 5px; width: fit-content;">                     ADJUST TO 20 mA                       THEN HIT ENTER                 </div>	Use the arrow keys to adjust the 20 mA signal.
	<div style="border: 1px solid black; padding: 5px; width: fit-content;">                     ID TAGNAME                       READY                 </div>	

**METER VALUE ADJUSTMENT**





Use this function to adjust the four to 20 milliampere output of the field device using values from an external current meter. This method is only valid for HART devices.

Key	Display	Comments
	<div style="border: 1px solid black; padding: 5px; width: fit-content;">                     OUTPUT WILL BE                      AFFECTED! PROCEED?                      NO                      → YES                 </div>	This operation will cause a change in output not corresponding to the input. Be sure the control loop is in manual.  Select <i>YES</i> .
		
	<div style="border: 1px solid black; padding: 5px; width: fit-content;">                     CALIBRATION                      → D-TO-A ADJUST                      BENCH CALIB.                 </div>	Select <i>D-TO-A ADJUST</i> .
	<div style="border: 1px solid black; padding: 5px; width: fit-content;">                     D/A CAL USING                      UPDOWN ARROW KEYS                      →METER VALUE ENTRY                 </div>	Select <i>METER VALUE ENTRY</i> .
		

Key	Display	Comments
	<div style="border: 1px solid black; padding: 5px;">                     4 mA CALIBRATION                      ENTER METER VALUE                       THEN HIT ENTER                 </div>	Use the number keys to enter the current meter reading.
	<div style="border: 1px solid black; padding: 5px;">                     20 mA CALIBRATION                      ENTER METER VALUE                       THEN HIT ENTER                 </div>	Use the number keys to enter the current meter reading.
	<div style="border: 1px solid black; padding: 5px;">                     ID TAGNAME                       READY                 </div>	

**Zero Trim Calibration**

The zero trim calibration procedure allows you to zero the transmitter without going through the complete bench calibration procedure.

Key	Display	Comments
	<div style="border: 1px solid black; padding: 5px;">                     OUTPUT WILL BE                      AFFECTED! PROCEED?                      NO                      → YES                 </div>	This operation will cause a change in output not corresponding to the input. Be sure the control loop is in manual.  Select <i>YES</i> .
		
	<div style="border: 1px solid black; padding: 5px;">                     INPUT A/D CAL                      D-TO-A ADJUST                      → ZERO TRIM                      TEMP. CAL                 </div>	Select <i>ZERO TRIM</i> .  If digitally configured, the <i>D-TO-A ADJUST</i> selection will not appear.
		
		

## AS800 PRESSURE TRANSMITTER

Key	Display	Comments
ENTER	APPLY 0 INPUT TO SENSOR  THEN HIT ENTER	Apply zero value to the transmitter.
ENTER	ID TAGNAME  READY	ZERO TRIM is complete.

### Temperature Calibration

Key	Display	Comments
CALIBRATE	OUTPUT WILL BE AFFECTED! PROCEED? NO → YES	This operation will cause a change in output not corresponding to the input. Be sure the control loop is in manual.  Select YES.
↓		
ENTER	INPUT A/D CAL D-TO-A ADJUST ZERO TRIM → TEMP. CAL	Select TEMP. CAL.  If digitally configured, the D-TO-A ADJUST selection will not appear.
↓		
↓		
↓		
ENTER	ENTER SENSOR TEMPERATURE	Enter TEMPERATURE value, <b>ENTER</b> .

	<p>ID TAGNAME READY</p>	<p><i>TEMPERATURE CALIBRATION</i> is complete</p>
---	-----------------------------	---

# APPENDIX Q - 600T & 600T EN PRESSURE TRANSMITTER

## INTRODUCTION

This appendix covers the configuration and calibration functions of the Type 600T EN Pressure Transmitter.

Refer to **OPERATING PROCEDURES** in Section 4 for information on the following functions:

- Send configurations.
- Get configurations.
- View configurations.
- Select configurations.
- Erase configurations.
- Operational functions.

## CREATE/MODIFY CONFIGURATION

A configuration can be created off-line, without a connected field device. Refer to Figure Q-1 for an overview of the configuration function. The following table details the configuration process.

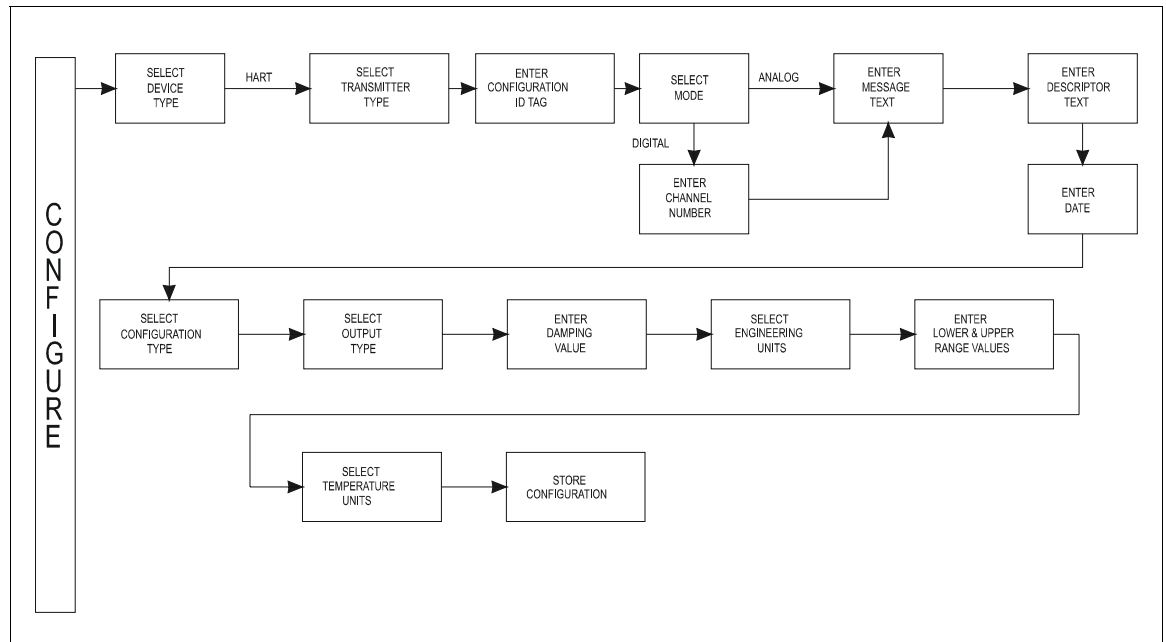







Figure Q-1. Configuration Flowchart (600T & 600T EN)



Key	Display	Comments
ENTER	<p>DESCRIPTOR:</p> <p>←PREVIOUS NEXT→</p>	<p>Type a descriptor string using up to 16 characters. This field can be used for notations about the device or process.</p> <p>To select a character, press the key that has the desired character. Continue to press the key until the desired character appears. Use the right arrow key to move to the next character. Use the left arrow key to go back to the previous character.</p>
ENTER	<p>DATE:</p> <p>DAY: nn</p> <p>MONTH: nn</p> <p>YEAR: nn</p>	<p>Enter a day and press <b>ENTER</b>. Enter a month and press <b>ENTER</b>. Enter a year and press <b>ENTER</b>.</p> <p>This date can represent the creation date of the configuration, the date the device or element was installed, or some other significant date.</p>
	<p>CONFIG TYPE</p> <p>600T</p> <p>→ 600T EN</p>	<p>Select <i>600T EN</i></p>
ENTER		
ENTER	<p>OUTPUT TYPE</p> <p>→ LINEAR</p> <p>SQU (x)</p> <p>SQR (x<sup>3</sup>)</p> <p>SQR (x<sup>5</sup>)</p> <p>5th ORD. POLY</p> <p>DOUBLE POLYN</p>	<p>Select <i>LINEAR</i>.</p> <p><b>NOTE:</b> Other output type selections are:</p> <p><i>SQUARE ROOT</i></p> <p><i>SQR (x<sup>3</sup>)</i></p> <p><i>SQR (x<sup>5</sup>)</i></p> <p><i>5th ORDER POLYNOMIAL</i></p> <p><i>DOUBLE POLYN</i></p>
ENTER		
ENTER	<p>DAMPING:</p> <p>(0 - 16 SEC)</p> <p>0.5 SECS</p>	<p>Use <b>BACK</b> to return to a previous configuration screen from any screen in the configuration process.</p> <p>Enter a value between 0 and 16 seconds.</p>
ENTER	<p>ENGINEERING UNIT</p> <p>→ iH2O-20c</p> <p>iHg-0<sup>o</sup>c</p> <p>ftH2O-20c</p> <p>mmH2O-20c</p>	<p>Select an engineering unit best suited for the application. Other units not shown include <i>mmHg-0<sup>o</sup>C</i>, <i>PSI</i>, <i>BARS</i>, <i>mBAR</i>, <i>gSqCm</i>, <i>Kgcm2</i>, <i>PA</i>, <i>KPA</i>, <i>torr-0<sup>o</sup>C</i>, <i>ATM</i>, <i>MPa</i>, <i>iH2O-4<sup>o</sup>C</i>, <i>mmH2O-4<sup>o</sup>C</i>.</p>



## 600T & 600T EN PRESSURE TRANSMITTER

Key	Display	Comments
	<div style="border: 1px solid black; padding: 5px;">                     LOWER RANGE VAL                      nn.nn UNITS                      UPPER RANGE VAL                      nn.nn UNITS                 </div>	Input lower range value using the number keys, then press <b>ENTER</b> . Input the upper range value, then press <b>ENTER</b> .
	<div style="border: 1px solid black; padding: 5px;">                     TEMPERATURE UNITS                      → °C    °F                         °R    °K                 </div>	Select the 600T EN <i>TEMPERATURE UNITS</i> . Use arrow key to select option, then press <b>ENTER</b> .
	<div style="border: 1px solid black; padding: 5px;">                     STORE THIS                      CONFIGURATION?                      NO                      → YES                 </div>	Select YES.
		
	<div style="border: 1px solid black; padding: 5px;">                     ID TAGNAME                      READY                 </div>	

**CALIBRATION**

This section details the 600T EN pressure transmitter calibration functions using an STT04 terminal. There are four types of calibration functions:

- Sensor Trim
- D-to-A adjust (Analog Mode only)
- PV Bias
- Set Output %

Refer to Figure Q-2 for an overview of the calibration functions.

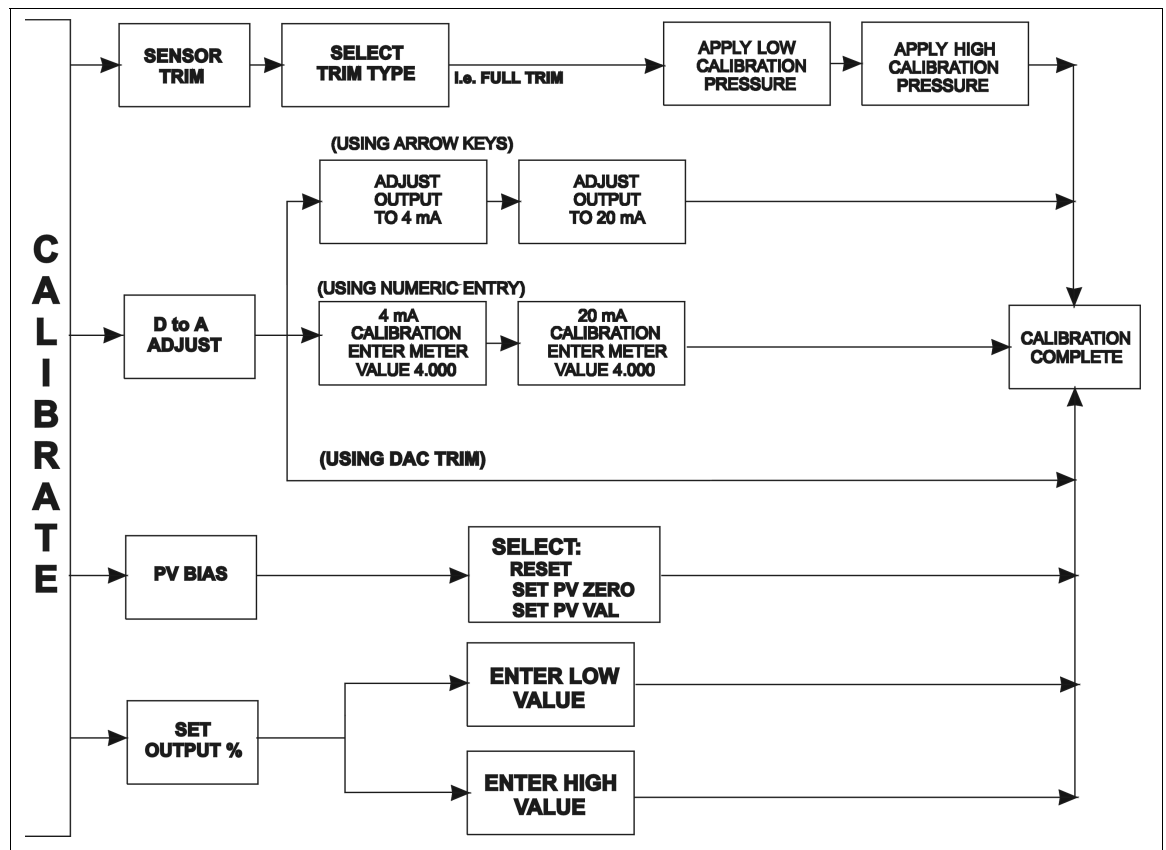









Figure Q-2. Calibration Flowchart (600T EN)

**Sensor Trim**

This procedure allows calibration of the pressure sensors for 600T EN pressure transmitters. Selections available are FULL TRIM, ZERO TRIM, FACTORY TRIM and STATIC TRIM.









**FULL TRIM**

Use this option if both LOW (min.) and HIGH (max.) pressure settings are to be calibrated.

Key	Display	Comments
	OUTPUT WILL BE AFFECTED! PROCEED? NO → YES	This operation will cause a change in output not corresponding to the input. Be sure the control loop is in manual.  Select YES.
		
		
	→ SENSOR TRIM D-TO-A ADJUST PV BIAS SET OUTPUT %	Select <i>SENSOR TRIM</i> , or select calibration option with down-arrow key and refer to the appropriate section. Press <b>ENTER</b> when done.
	→ FULL TRIM ZERO TRIM FACTORY TRIM STATIC TRIM	Select <i>FULL TRIM</i> .
	LOW CALIB PRESSURE nn.nn UNITS HIGH CALIB PRESSURE nn.nn UNITS	Enter the low calibration pressure value using the number keys and press <b>ENTER</b> . Similarly, enter the high calibration pressure value, then press <b>ENTER</b> .
	APPLY PRESSURE OF nn.nn UNITS  THEN HIT ENTER	Apply the low calibration pressure to the input of transmitter as specified earlier.
	APPLY PRESSURE OF nn.nn UNITS  THEN HIT ENTER	Apply the high calibration pressure to the input of transmitter as specified earlier.









**ZERO TRIM**

Use this option if only the LOW (min.) pressure setting is to be calibrated

Key	Display	Comments
  	<div style="border: 1px solid black; padding: 5px;">                     OUTPUT WILL BE                      AFFECTED! PROCEED?                      NO                      → YES                 </div>	This operation will cause a change in output not corresponding to the input. Be sure the control loop is in manual.  Select <b>YES</b> .
	<div style="border: 1px solid black; padding: 5px;">                     → SENSOR TRIM                      D-TO-A ADJUST                      PV BIAS                      SET OUTPUT %                 </div>	Select <i>SENSOR TRIM</i> , or select calibration option with down-arrow key and refer to the appropriate section. Press <b>ENTER</b> when done.
 	<div style="border: 1px solid black; padding: 5px;">                     FULL TRIM                      → ZERO TRIM                      FACTORY TRIM                      STATIC TRIM                 </div>	Select <i>ZERO TRIM</i> .
	<div style="border: 1px solid black; padding: 5px;">                     APPLY 0 INPUT                      TO SENSOR                       THEN HIT ENTER                 </div>	Apply the pressure equal to the zero value of the instrument and press <b>ENTER</b> .
	<div style="border: 1px solid black; padding: 5px;">                     APPLIED ZERO INPUT:  <i>value</i> units                      PRESS ENTER                      TO CONTINUE                 </div>	The instrument reads the pressure applied and displays its value. Press <b>ENTER</b> .
	<div style="border: 1px solid black; padding: 5px;">                     ID TAGNAME                       READY                 </div>	









**FACTORY TRIM**

Use this option if factory setting is to be used for calibration.

Key	Display	Comments
	<div style="border: 1px solid black; padding: 5px;">                     OUTPUT WILL BE AFFECTED! PROCEED? NO → YES                 </div>	This operation will cause a change in output not corresponding to the input. Be sure the control loop is in manual.  Select <b>YES</b> .
		
		
	<div style="border: 1px solid black; padding: 5px;">                     → SENSOR TRIM D-TO-A ADJUST PV BIAS SET OUTPUT %                 </div>	Select <i>SENSOR TRIM</i> , or select calibration option with down-arrow key and refer to the appropriate section. Press <b>ENTER</b> when done.
	<div style="border: 1px solid black; padding: 5px;">                     FULL TRIM ZERO TRIM → FACTORY TRIM STATIC TRIM                 </div>	Select <i>FACTORY TRIM</i> .
		
		
	<div style="border: 1px solid black; padding: 5px;">                     ID TAGNAME  READY                 </div>	

**STATIC TRIM**

Use this option if the instrument is to be statically calibrated using a known pressure.

Key	Display	Comments
  	<div data-bbox="597 428 932 569" style="border: 1px solid black; padding: 5px;">                     OUTPUT WILL BE AFFECTED! PROCEED?                      NO                      → YES                 </div>	This operation will cause a change in output not corresponding to the input. Be sure the control loop is in manual.  Select YES.
	<div data-bbox="597 848 932 982" style="border: 1px solid black; padding: 5px;">                     → SENSOR TRIM                      D-TO-A ADJUST                      PV BIAS                      SET OUTPUT %                 </div>	Select <i>SENSOR TRIM</i> , or select calibration option with down-arrow key and refer to the appropriate section. Press <b>ENTER</b> when done.
 [ 3 TIMES ]	<div data-bbox="597 1024 932 1159" style="border: 1px solid black; padding: 5px;">                     FULL TRIM                      ZERO TRIM                      FACTORY TRIM                      → STATIC TRIM                 </div>	Select <i>STATIC TRIM</i> .
		
	<div data-bbox="597 1318 932 1453" style="border: 1px solid black; padding: 5px;">                     STATIC PRESSURE  <i>value</i> units                      PRESS ENTER                      TO MODIFY                 </div>	Display shows the value of the pressure measured by the 600T EN transmitter.
	<div data-bbox="597 1499 932 1633" style="border: 1px solid black; padding: 5px;">                     STATIC PRESSURE   <i>value</i> units                 </div>	Enter the value of the actual static pressure using the number keys.
	<div data-bbox="597 1680 932 1814" style="border: 1px solid black; padding: 5px;">                     ID TAGNAME                       READY                 </div>	







**D-to-A Adjust**

The *D-TO-A ADJUST* selection is only present when you are in the *ANALOG* communication mode. There are three methods available to adjust the four to 20 milliampere output:

- Up/Down Arrow keys.
- Meter value entry for HART devices.
- Factory DAC Trim

**ARROW KEY ADJUSTMENT**

Use this function to adjust the 4 to 20 milliampere output of the field device using the up and down arrow keys.

Key	Display	Comments
 	<div style="border: 1px solid black; padding: 5px;">                     OUTPUT WILL BE AFFECTED! PROCEED?                      NO                      → YES                 </div>	This operation will cause a change in output not corresponding to the input. Be sure the control loop is in manual.  Select <i>YES</i> .
 	<div style="border: 1px solid black; padding: 5px;">                     CALIBRATION                      SENSOR TRIM                      → D-TO-A ADJUST                      PV BIAS                      SET OUTPUT %                 </div>	Select <i>D-TO-A ADJUST</i> .
 	<div style="border: 1px solid black; padding: 5px;">                     D/A CAL USING                      → UPDOWN ARROW KEYS                      METER VALUE ENTRY                 </div>	Select <i>UPDOWN ARROW KEYS</i> .
	<div style="border: 1px solid black; padding: 5px;">                     ADJUST TO 4 mA                       THEN HIT ENTER                 </div>	Use the arrow keys to adjust the 4 mA signal.  <b>NOTE:</b> When increasing or decreasing the mA signal, the increments of change increase with successive depressions until the maximum level of change is reached. By changing direction you will return to the smallest increment of change. This adjustment technique speeds up the adjustment process without affecting fine adjustment.

Key	Display	Comments
ENTER	ADJUST TO 20 mA THEN HIT ENTER	Use the arrow keys to adjust the 20 mA signal.
ENTER	ID TAGNAME READY	

**METER VALUE ADJUSTMENT**

Use this function to adjust the four to 20 milliampere output of the field device using values from an external current meter. This method is only valid for HART devices.

Key	Display	Comments
CALIBRATE	OUTPUT WILL BE AFFECTED! PROCEED? NO → YES	This operation will cause a change in output not corresponding to the input. Be sure the control loop is in manual. Select YES.
↓		
ENTER		
↓	CALIBRATION SENSOR TRIM → D-TO-A ADJUST PV BIAS SET OUTPUT %	Select D-TO-A ADJUST.
ENTER		
ENTER	D/A CAL USING UPDOWN ARROW KEYS → METER VALUE ENTRY	Select METER VALUE ENTRY.



## 600T & 600T EN PRESSURE TRANSMITTER









Key	Display	Comments
ENTER	4 mA CALIBRATION: ENTER METER VALUE n.nnnn	Use the number keys to enter the current meter reading.
ENTER	20 mA CALIBRATION: ENTER METER VALUE nn.nnnn	Use the number keys to enter the current meter reading.
ENTER	ID TAGNAME  READY	

### PV Bias









The PV Bias calibration procedure allows you to align the "zero" of the process with the "zero" reading of the transmitter. This may be done in one of two ways:

- Apply a pressure that corresponds to the desired zero offset or bias [SET PV ZERO]
- To scale to a value different from zero, calculate the offset or bias and apply it to the 600T EN [SET PV VAL]

Key	Display	Comments
CALIBRATE	OUTPUT WILL BE AFFECTED! PROCEED? NO → YES	This operation will cause a change in output not corresponding to the input. Be sure the control loop is in manual.  Select YES.
↓		
ENTER		

Key	Display	Comments
  	<div style="border: 1px solid black; padding: 5px;">                     CALIBRATION                      SENSOR TRIM                      D-TO-A ADJUST                      → PV BIAS                      SET OUTPUT %                 </div>	Select <i>PV BIAS</i> .  If digitally configured, the <i>D-TO-A ADJUST</i> selection will not appear.
	<div style="border: 1px solid black; padding: 5px;">                     PV BIAS                      → RESET                      SET PV ZERO                      SET PV VAL                 </div>	Use the arrow keys to scroll to the desired PV BIAS parameter. RESET removes any previously configured bias values. The following procedure is used to establish the zero offset for SET PV ZERO, the procedure for SET PV VAL is similar.
 	<div style="border: 1px solid black; padding: 5px;">                     PV BIAS                      RESET                      → SET PV ZERO                      SET PV VAL                 </div>	Apply the desired zero pressure value to the transmitter. Scroll to SET PV ZERO using the down arrow key and press <b>ENTER</b> .
	<div style="border: 1px solid black; padding: 5px;">                     PV VALUE READ:                      value units                      PRESS ENTER                      TO SET PV ZERO                 </div>	Pressing <b>ENTER</b> calibrates the PV ZERO value.
	<div style="border: 1px solid black; padding: 5px;">                     ID TAGNAME                       READY                 </div>	SET PV ZERO is complete.

Set Output %

Key	Display	Comments
  	<p>OUTPUT WILL BE AFFECTED! PROCEED? NO → YES</p>	<p>This operation will cause a change in output not corresponding to the input. Be sure the control loop is in manual. Select YES.</p>
 <p>[ 3 TIMES ]</p> 	<p>CALIBRATION SENSOR TRIM D-TO-A ADJUST PV BIAS → SET OUTPUT %</p>	<p>Select SET OUTPUT %. If digitally configured, the D-TO-A ADJUST selection will not appear.</p>
	<p>SET OUTPUT % → LOW HIGH</p>	<p>Select LOW and press <b>ENTER</b>. (Procedure for HIGH selection is identical).</p>
	<p>OP %: nnn.nn % PV VAL: <i>value</i> units Hit ENTER to set OP%</p>	<p>Display indicates present data.</p>
	<p>ENTER NEW VALUE  <i>value</i> %</p>	<p>Enter LOW value, <b>ENTER</b>.</p>
	<p>ID TAGNAME READY</p>	

## AVS Smart Positioner Configuration

IDTAG ( $\leq 14$  digits, alphanumeric)

---

MODE  Analog  Digital \_\_\_\_\_ Channel Number

---

INPUT CHARACTERISTICS  Linear  Square root  Square  
 Equal %  Function Generator  Quick act

---

FUNCTION GENERATOR	Input	Output
	_____ %	Point 0
	_____ %	Point 1
	_____ %	Point 2
	_____ %	Point 3
	_____ %	Point 4
	_____ %	Point 5
	_____ %	Point 6
	_____ %	Point 7
	_____ %	Point 8
	_____ %	Point 9
	_____ %	Point 10

---

LOWER RANGE VALUE \_\_\_\_\_ Specified LRV \_\_\_\_\_ LRV

---

UPPER RANGE VALUE \_\_\_\_\_ Specified URV \_\_\_\_\_ URV

---

VALVE STUCK ALARM  Yes  No

---

PRESSURE UNITS  psi  bars

---

PID PARAMETERS  Kp  Ki  Kd

---

INPUT SIGNAL  Normal act  Reverse act

---

DAMPING \_\_\_\_\_ sec (0.00<sup>1</sup> to 32.00 sec)

---

ALARMS \_\_\_\_\_ Deviation alarm \_\_\_\_\_ Low pressure alarm \_\_\_\_\_ High pressure alarm

---

LOW FLOW SHUT OFF \_\_\_\_\_ %

---

DO3 ACTION  Lo pressure  Deviation alarm  Valve stuck alarm  Status

---

**NOTES:**

1. Default parameters.

# BCN Smart Electronic Pressure Transmitter Configuration

IDTAG ( $\leq 14$  digits, alphanumeric)

MODE  Analog  Digital \_\_\_\_\_ Channel Number

OUTPUT TYPE  Linear<sup>1</sup>  Square root  3/2 Flow Mode  
 5/2 Flow Mode  Vol./Sphere  Vol./Cylinder  
 Function Generator

## FUNCTION GENERATOR

Input \_\_\_\_\_% Point 0  
 \_\_\_\_\_% Point 1  
 \_\_\_\_\_% Point 2  
 \_\_\_\_\_% Point 3  
 \_\_\_\_\_% Point 4  
 \_\_\_\_\_% Point 5

Output \_\_\_\_\_% Point 0  
 \_\_\_\_\_% Point 1  
 \_\_\_\_\_% Point 2  
 \_\_\_\_\_% Point 3  
 \_\_\_\_\_% Point 4  
 \_\_\_\_\_% Point 5

OUTPUT ACTION  Normal<sup>1</sup>  Reverse

DAMPING \_\_\_\_\_ sec (0.00<sup>1</sup> to 32.00 sec)

ENGINEERING UNITS  iH<sub>2</sub>O<sup>1</sup>  mmHG  cmH<sub>2</sub>O  
 psi  MPA  kPa  
 BARS  mBARS  kg/cm<sup>2</sup>

LOWER RANGE VALUE \_\_\_\_\_ Specified LRV

UPPER RANGE VALUE \_\_\_\_\_ Specified URV

INITIALIZE MODE<sup>2</sup>  Low  High

FAIL MODE<sup>2</sup>  Low  High  Last

SECONDARY UNITS \_\_\_\_\_ Secondary LRV  
 \_\_\_\_\_ Secondary URV

### NOTES:

1. Default parameters.
2. Select to maintain safe operation during start-up and diagnostically detected failures of the transmitter.

# EBTH Platinum Standard Series Temperature Transmitter Configuration

IDTAG (≤8 digits, alphanumeric)

MODE  Analog  Digital

MESSAGE DESCRIPTOR

DATE \_\_\_\_\_ Day/month/year

SENSOR TYPE  Thermocouple  RTD  Millivolt  Ohms

Thermocouple  N  B  E  J  K  R  S  T  C

RTD  100 Ohms (Pt 385)  100 Ohms (Pt 392)

NUMBER OF ELEMENTS  Single  Dual

Number of Wires  2  3  4

ENGINEERING UNITS  Celsius  Fahrenheit  Kelvin  Richter

OUTPUT TYPE Function Generator  Yes  No

Input	_____ % Point 1	_____ % Point 6	_____ % Point 11	_____ % Point 16
	_____ % Point 2	_____ % Point 7	_____ % Point 12	_____ % Point 17
	_____ % Point 3	_____ % Point 8	_____ % Point 13	_____ % Point 18
	_____ % Point 4	_____ % Point 9	_____ % Point 14	_____ % Point 19
	_____ % Point 5	_____ % Point 10	_____ % Point 15	_____ % Point 20
Output	_____ % Point 1	_____ % Point 6	_____ % Point 11	_____ % Point 16
	_____ % Point 2	_____ % Point 7	_____ % Point 12	_____ % Point 17
	_____ % Point 3	_____ % Point 8	_____ % Point 13	_____ % Point 18
	_____ % Point 4	_____ % Point 9	_____ % Point 14	_____ % Point 19
	_____ % Point 5	_____ % Point 10	_____ % Point 15	_____ % Point 20

OUTPUT ACTION  Normal  Reverse

DAMPING \_\_\_\_\_ sec (0.00 to 32.00 sec)

LOWER RANGE VALUE \_\_\_\_\_ Specified LRV \_\_\_\_\_ LRV

UPPER RANGE VALUE \_\_\_\_\_ Specified URV \_\_\_\_\_ URV

INITIALIZE MODE<sup>1</sup>  Low  High

FAIL MODE<sup>1</sup>  Low  High  Last

SECONDARY UNITS \_\_\_\_\_ Secondary LRV \_\_\_\_\_ Secondary URV

TEMPERATURE ALARM \_\_\_\_\_ Lower \_\_\_\_\_ Upper

**NOTE:**

1. Select to maintain safe operation during start-up and diagnostically detected failures of the transmitter.

# EQN Smart Electronic Temperature Transmitter Configuration

IDTAG ( $\leq 14$  digits, alphanumeric)

MODE  Analog  Digital \_\_\_\_\_ Channel Number

## SENSOR TYPE

Thermocouple  N  B  E  J  K  R  S  T  C

RTD  100 Ohms (Pt 385)  100 Ohms (Pt 392)

Type  2-wire  3-wire  Dual

MILLIVOLT

OHMS  2-wire  3-wire  Dual

## OUTPUT TYPE

Function Generator  Yes  No

Input \_\_\_\_\_% Point 1  
 \_\_\_\_\_% Point 2  
 \_\_\_\_\_% Point 3  
 \_\_\_\_\_% Point 4  
 \_\_\_\_\_% Point 5

Output \_\_\_\_\_% Point 1  
 \_\_\_\_\_% Point 2  
 \_\_\_\_\_% Point 3  
 \_\_\_\_\_% Point 4  
 \_\_\_\_\_% Point 5

OUTPUT ACTION  Normal<sup>1</sup>  Reverse

DAMPING \_\_\_\_\_ sec (0.00<sup>1</sup> to 32.00 sec)

ENGINEERING UNITS<sup>2</sup>  Celsius  Fahrenheit  Kelvin

LOWER RANGE VALUE \_\_\_\_\_ Specified LRV \_\_\_\_\_ LRV

UPPER RANGE VALUE \_\_\_\_\_ Specified URV \_\_\_\_\_ URV

INITIALIZE MODE<sup>3</sup>  Low  High

FAIL MODE<sup>3</sup>  Low  High  Last

### NOTES:

1. Default parameters.
2. Not applicable in millivolt mode.
3. Select to maintain safe operation during start-up and diagnostically detected failures of the transmitter.

## EQS Platinum Standard Series Smart Temperature Transmitter Configuration

IDTAG (≤14 digits, alphanumeric)

MODE  Analog  Digital \_\_\_\_\_ Channel Number

TRANSMITTER MODE  Thermocouple  RTD  Millivolt  Ohms

Thermocouple  N  B  E  J  K  R  S  T  C

RTD  100 Ohms (pt 385)  100 Ohms (pt 392)

NUMBER OF ELEMENTS  Single  Dual

Number of Wires  2  3  4

ENGINEERING UNITS  Celsius  Fahrenheit  Kelvin

### OUTPUT TYPE

Function Generator  Yes  No

Input \_\_\_\_\_% Point 1  
 \_\_\_\_\_% Point 2  
 \_\_\_\_\_% Point 3  
 \_\_\_\_\_% Point 4  
 \_\_\_\_\_% Point 5

Output \_\_\_\_\_% Point 1  
 \_\_\_\_\_% Point 2  
 \_\_\_\_\_% Point 3  
 \_\_\_\_\_% Point 4  
 \_\_\_\_\_% Point 5

OUTPUT ACTION  Normal  Reverse

DAMPING \_\_\_\_\_ sec (0.00 to 32.00 sec)

LOWER RANGE VALUE \_\_\_\_\_ Specified LRV \_\_\_\_\_ LRV

UPPER RANGE VALUE \_\_\_\_\_ Specified URV \_\_\_\_\_ URV

INITIALIZE MODE<sup>2</sup>  Low  High

FAIL MODE<sup>2</sup>  Low  High  Last

SECONDARY UNITS \_\_\_\_\_ Secondary LRV \_\_\_\_\_ Secondary URV

TEMPERATURE ALARM \_\_\_\_\_ Lower \_\_\_\_\_ Upper

### NOTES:

1. Default parameters.
2. Select to maintain safe operation during start-up and diagnostically detected failures of the transmitter.



# PTH Smart Electronic Pressure Transmitter Configuration

IDTAG ( $\leq 8$  digits, alphanumeric)

MODE  Analog  Digital \_\_\_\_\_ Channel number

MESSAGE \_\_\_\_\_ DESCRIPTOR \_\_\_\_\_

DATE \_\_\_\_\_ Day/month/year

OUTPUT TYPE  Linear<sup>1</sup>  Square root  3/2 flow mode  5/2 flow mode  
 Vol./sphere  Vol./cylinder  Function generator

## FUNCTION GENERATOR

Input \_\_\_\_\_% Point 0  
 \_\_\_\_\_% Point 1  
 \_\_\_\_\_% Point 2  
 \_\_\_\_\_% Point 3  
 \_\_\_\_\_% Point 4  
 \_\_\_\_\_% Point 5

Output \_\_\_\_\_% Point 0  
 \_\_\_\_\_% Point 1  
 \_\_\_\_\_% Point 2  
 \_\_\_\_\_% Point 3  
 \_\_\_\_\_% Point 4  
 \_\_\_\_\_% Point 5

OUTPUT ACTION  Normal<sup>1</sup>  Reverse

DAMPING \_\_\_\_\_ sec (0.00<sup>1</sup> to 32.00 sec)

ENGINEERING UNITS  iH<sub>2</sub>O<sup>1</sup>  mmH<sub>2</sub>O  mmHg  psi  BARS  
 mBARS  kg/cm<sup>2</sup>  kPa

LOWER RANGE VALUE \_\_\_\_\_ Specified LRV

UPPER RANGE VALUE \_\_\_\_\_ Specified URV

INITIALIZE MODE<sup>2</sup>  Low  High

FAIL MODE<sup>2</sup>  Low  High  Last

SECONDARY UNITS \_\_\_\_\_ Secondary LRV \_\_\_\_\_ Secondary URV

TEMPERATURE ALARM \_\_\_\_\_ Lower \_\_\_\_\_ Upper

### NOTES:

1. Default parameters.
2. Select to maintain safe operation during start-up and diagnostically detected failures of the transmitter.

# PTS Smart Electronic Pressure Transmitter Configuration

IDTAG ( $\leq 14$  digits, alphanumeric)

MODE  Analog  Digital \_\_\_\_\_ Channel number

OUTPUT TYPE  Linear<sup>1</sup>  Square root  3/2 flow mode  5/2 flow mode  
 Vol./sphere  Vol./cylinder  Function generator

## FUNCTION GENERATOR

Input \_\_\_\_\_% Point 0  
 \_\_\_\_\_% Point 1  
 \_\_\_\_\_% Point 2  
 \_\_\_\_\_% Point 3  
 \_\_\_\_\_% Point 4  
 \_\_\_\_\_% Point 5

Output \_\_\_\_\_% Point 0  
 \_\_\_\_\_% Point 1  
 \_\_\_\_\_% Point 2  
 \_\_\_\_\_% Point 3  
 \_\_\_\_\_% Point 4  
 \_\_\_\_\_% Point 5

OUTPUT ACTION  Normal<sup>1</sup>  Reverse

DAMPING \_\_\_\_\_ sec (0.00<sup>1</sup> to 32.00 sec)

ENGINEERING UNITS  iH<sub>2</sub>O<sup>1</sup>  mmHg  cmH<sub>2</sub>O  psi  MPA  
 kPa  BARS  mBARS  kg/cm<sup>2</sup>

LOWER RANGE VALUE \_\_\_\_\_ Specified LRV

UPPER RANGE VALUE \_\_\_\_\_ Specified URV

INITIALIZE MODE<sup>2</sup>  Low  High

FAIL MODE<sup>2</sup>  Low  High  Last

SECONDARY UNITS \_\_\_\_\_ Secondary LRV \_\_\_\_\_ Secondary URV

TEMPERATURE ALARM \_\_\_\_\_ Lower \_\_\_\_\_ Upper

### NOTES:

1. Default parameters.
2. Select to maintain safe operation during start-up and diagnostically detected failures of the transmitter.

## TBN480 Smart Conductivity Transmitter Configuration

IDTAG (≤14 digits, alphanumeric)

---

MODE  Analog  Digital \_\_\_\_\_ Channel Number

---

ANALYZER TYPE  General  Pure H<sub>2</sub>O Cond.  Concentration

---

SENSOR GROUP  A  B  C

---

RANGE JUMPER  High  Medium  Low

---

ANALYZER RANGE  0-99.9 μS/cm  0-9.99 μS/cm

---

TEMP. COMP. INPUT  Manual  3.01k Balco

---

DAMPING \_\_\_\_\_ sec (0.00<sup>1</sup> to 32.00 sec)

---

LOWER RANGE VALUE \_\_\_\_\_ Specified LRV \_\_\_\_\_ LRV

---

UPPER RANGE VALUE \_\_\_\_\_ Specified URV \_\_\_\_\_ URV

---

INITIALIZE MODE<sup>2</sup>  Low  High

---

FAIL MODE<sup>2</sup>  Low  High  Last

---

DIAG. SPIKE OUTPUT  No  Yes

---

**NOTES:**

1. Default parameters.
2. Select to maintain safe operation during start-up and diagnostically detected failures of the transmitter.

## TBN580 Smart pH Transmitter Configuration

IDTAG ( $\leq 14$  digits, alphanumeric)

---

MODE  Analog  Digital \_\_\_\_\_ Channel Number

---

pH SENSOR INPUT  Standard  Antimony

---

TEMP. COMP. INPUT  3.01k Balco  None (manual)

---

TEMPERATURE DISPLAY  C°  F°

---

### OUTPUT TYPE

Function Generator  Yes  No

Input \_\_\_\_\_% Point 1

\_\_\_\_\_% Point 2

\_\_\_\_\_% Point 3

\_\_\_\_\_% Point 4

\_\_\_\_\_% Point 5

Output \_\_\_\_\_% Point 1

\_\_\_\_\_% Point 2

\_\_\_\_\_% Point 3

\_\_\_\_\_% Point 4

\_\_\_\_\_% Point 5

---

OUTPUT ACTION  Normal<sup>1</sup>  Reverse

---

DAMPING \_\_\_\_\_ sec (0.00<sup>1</sup> to 32.00 sec)

---

LOWER RANGE VALUE \_\_\_\_\_ Specified LRV \_\_\_\_\_ LRV

---

UPPER RANGE VALUE \_\_\_\_\_ Specified URV \_\_\_\_\_ URV

---

INITIALIZE MODE<sup>2</sup>  Low  High

---

FAIL MODE<sup>2</sup>  Low  High  Last

---

SECONDARY UNITS \_\_\_\_\_ Secondary LRV

\_\_\_\_\_ Secondary URV

---

### NOTES:

1. Default parameters.

2. Select to maintain safe operation during start-up and diagnostically detected failures of the transmitter.

# TBN581 Smart ORP/pION Transmitter Configuration

IDTAG ( $\leq 14$  digits, alphanumeric)

MODE  Analog  Digital \_\_\_\_\_ Channel Number

## OUTPUT TYPE

Function Generator  Yes  No

Input	_____ %	Point 1
	_____ %	Point 2
	_____ %	Point 3
	_____ %	Point 4
	_____ %	Point 5
Output	_____ %	Point 1
	_____ %	Point 2
	_____ %	Point 3
	_____ %	Point 4
	_____ %	Point 5

OUTPUT ACTION  Normal<sup>1</sup>  Reverse

DAMPING \_\_\_\_\_ sec (0.00<sup>1</sup> to 32.00 sec)

LOWER RANGE VALUE \_\_\_\_\_ Specified LRV \_\_\_\_\_ LRV

UPPER RANGE VALUE \_\_\_\_\_ Specified URV \_\_\_\_\_ URV

INITIALIZE MODE<sup>2</sup>  Low  High

FAIL MODE<sup>2</sup>  Low  High  Last

SECONDARY UNITS \_\_\_\_\_ Secondary LRV

\_\_\_\_\_ Secondary URV

### NOTES:

1. Default parameters.
2. Select to maintain safe operation during start-up and diagnostically detected failures of the transmitter.

## XM/SM/XE Magnetic Flowmeter Configuration

IDTAG ( $\leq 14$  digits, alphanumeric)

MODE  Analog  Digital \_\_\_\_\_ Channel Number

FLOW DIRECTION  Normal  Reverse

DAMPING \_\_\_\_\_ sec (0.00<sup>1</sup> to 32.00 sec)

SELECT PV EU  1/s  1/m  1/h  m<sup>3</sup>/s  m<sup>3</sup>/m  
 m<sup>3</sup>/h  gal/s  gal/m  gal/h  User defined

RANGE DN \_\_\_\_\_ PV EU

EU DESCRIPTOR \_\_\_\_\_

EU FACTOR \_\_\_\_\_

TIME RELATION  Per sec  Per min  Per hour

DENSITY FACTOR \_\_\_\_\_

RANGE VALUE 1 \_\_\_\_\_ Units

RANGE VALUE 2 \_\_\_\_\_ Units

FAIL MODE<sup>2</sup>  Low  High

SELECT TOTALIZER EU  1  m<sup>3</sup>  gal  User defined

PULSE FACTOR \_\_\_\_\_

PULSE WIDTH \_\_\_\_\_

LOW FLOW CUTOFF \_\_\_\_\_ %

DIGITAL FILTER  On  Off

RESPONSE TIME  Normal  Fast

RANGE CONFIGURATION  2-fwd  1-fwd, 1-rev

FLOW DIRECTION  Fwd and rev  Fwd only

UPPER PV ALARM \_\_\_\_\_ Units

EMPTY PIPE DET  On  Off

LOWER PV ALARM \_\_\_\_\_ Units

**NOTES:**

1. Default parameters.
2. Select to maintain safe operation during start-up and diagnostically detected failures of the transmitter.

## TZID/AZH Positioner Configuration

STT04 CONFIGURATION (ID tag up to 8 ASCII characters)

MODE  Analog  Digital \_\_\_\_\_ Channel number

TAG NUMBER \_\_\_\_\_

DESCRIPTOR \_\_\_\_\_

POSITIONING TASK \_\_\_\_\_

DATE \_\_\_\_\_ Day/month/year

SET POINT UNITS \_\_\_\_\_

LOW SET POINT RANGE \_\_\_\_\_

HIGH SET POINT RANGE \_\_\_\_\_

CHARACTERISTIC CURVE  Linear  Equal % 1:25  Equal % 1:50

Equal % 25:1  Equal % 50:1  User defined

VALVE ACTION  Direct  Reverse

DEAD BAND \_\_\_\_\_%

MINIMUM STROKE RANGE \_\_\_\_\_%

MAXIMUM STROKE RANGE \_\_\_\_\_%

SHUT-OFF VALUE \_\_\_\_\_%

DEADBAND TIME LIMIT \_\_\_\_\_ sec.

ADJUSTED TIME, UP \_\_\_\_\_ sec.

ADJUSTED TIME, DOWN \_\_\_\_\_ sec.

LOW ALARM LIMIT \_\_\_\_\_ sec.

HIGH ALARM LIMIT \_\_\_\_\_ sec.





# Index

<b>A</b>	
Adding a user .....	O-1
Auto shutoff .....	4-3
AVS calibration function .....	A-5
<b>B</b>	
Batteries .....	1-4, 3-2
Battery charger .....	3-2
Battery pack replacement .....	6-2
<b>C</b>	
Calibration	
AVS .....	A-5
Automatic .....	A-9
Input A/D .....	A-7
Manual .....	A-8
Output D/A .....	A-6
BCN .....	G-5
Bench .....	G-5
D/A .....	G-9
Rezero .....	G-8
EBTH .....	B-5
Bench .....	B-6
D/A .....	B-7
EQN .....	H-4
Bench .....	H-5
D/A .....	H-7
EQS .....	C-4
Bench .....	C-4
D/A .....	C-7
MagFlow .....	I-5
Bench .....	I-6
D/A .....	I-7
Empty pipe detector .....	I-6
PTH .....	D-5, P-5, 1-17
Bench .....	D-6, P-6, 1-18
D/A .....	D-8, P-7, 1-22
Rezero .....	D-8, P-9, 1-24
PTS .....	E-4
Bench .....	E-4
D/A .....	E-8
Rezero .....	E-7
TB82 .....	N-4
pH calibration .....	N-4
pH calibration, one point .....	N-5
pH calibration, two point .....	N-6
Temperature calibration .....	N-8
TBN480 .....	J-5
Process conductivity .....	J-5, J-6
Process temperature .....	J-7
TBN580 .....	K-5
Bench, pH .....	K-7
Bench, temperature .....	K-10
D/A .....	K-11
Process .....	K-6
TBN581 .....	L-4
A/D .....	L-9
Bench, mV .....	L-8
Bench, ORP/pION .....	L-6
Process .....	L-5
TZID/AZH .....	M-5
Auto stroke .....	M-5
Lever zero position .....	M-7
Manual range adjustment .....	M-6
Spring action actuator .....	M-8
Calibration flowcharts	
AVS .....	A-5
BCN .....	G-5
EBTH .....	B-5
EQN .....	H-5
EQS .....	C-5
MagFlow .....	I-6
PTH .....	D-5, P-5, 1-17
PTS .....	E-5
TB82 .....	N-4
TBN480 .....	J-5
TBN580 .....	K-5
TBN581 .....	L-5
TZID/AZH .....	M-5
Cancel fix output .....	4-12
Change STT04 name .....	O-12
Charging STT04 .....	3-2
Cleaning .....	7-1
Clip leads	
Installation .....	3-2
Removal .....	3-3
Codes (TB82)	
Error .....	N-23
Problem .....	N-17
Communication	
FSK .....	2-1
HART .....	2-1
Point-to-point .....	2-1
Communication format .....	4-22
Configuration	
AVS .....	A-1
BCN .....	G-1
Download to STT04 .....	4-25
EBTH .....	B-1
EQN .....	H-1
EQS .....	C-1
HART universal .....	F-1

# Index (continued)

MagFlow.....	I-1
PTH.....	D-1, P-1, 1-13
PTS.....	E-1
TB82.....	N-1
TBN480.....	J-1
TBN580.....	K-1
TBN581.....	L-1
TZID/AZH.....	M-1
Upload from STT04.....	4-25
Configuration flowcharts	
BCN.....	G-1
EQN.....	H-1
EQS.....	C-1
HART.....	F-1
MagFlow.....	I-1
PTH.....	D-1, P-1, 1-13
PTS.....	E-1
TB82.....	N-1
TBN480.....	J-1
TBN580.....	K-1
TBN581.....	L-1
TZID/AZH.....	M-1
Configuration storage capacity.....	1-4

## D

Device status.....	4-19
Digital field bus.....	2-1
Digital field bus wiring.....	2-2
Documentation.....	8-1
Download configuration to STT04.....	4-25
Downloading	
Configurations.....	4-25, O-8
Upgrades.....	6-3
D-to-A Adjust	
EBTH.....	B-7
PTH.....	D-8, P-7, 1-22

## E

Editing calibration constants	
Conductivity.....	J-8
Temperature.....	J-9
Erase configuration procedure.....	4-10
Error codes, TB82.....	N-23
Error messages.....	5-1
Errors	
FSK devices.....	5-5
HART devices.....	5-2
Exit utilities software.....	O-7

## F

Field bus.....	2-1
Field bus wiring.....	2-2
Firmware level.....	1-1, 1-3
Firmware upgrades.....	6-3
Fix output.....	4-12
Flowcharts	
Calibration	
AVS.....	A-5
BCN.....	G-5
EBTH.....	B-5
EQN.....	H-5
EQS.....	C-5
MagFlow.....	I-6
PTH.....	D-5, P-5, 1-17
PTS.....	E-5
TB82.....	N-4
TBN480.....	J-5
TBN580.....	K-5
TBN581.....	L-5
TZID/AZH.....	M-5
Configuration	
BCN.....	G-1
EBTH.....	B-1
EQN.....	H-1
EQS.....	C-1
HART.....	F-1
MagFlow.....	I-1
PTH.....	D-1, P-1, 1-13
PTS.....	E-1
TB82.....	N-1
TBN480.....	J-1
TBN580.....	K-1
TBN581.....	L-1
TZID/AZH.....	M-1
Frequency shift keying.....	2-1
FSK device errors.....	5-5
Functional operation.....	2-1

## G

Get configuration procedure.....	4-8
----------------------------------	-----

## H

HART.....	F-1
Communications.....	2-1
Device errors.....	5-2
Universal configuration procedure.....	F-1
Wiring.....	2-2, 3-3
How to use instruction book.....	1-2

**I**

Initial start-up ..... 4-3  
 Installation of utilities software ..... 3-4  
 Installing clip leads ..... 3-2

**L**

Language ..... 4-21  
 LCD setup ..... 4-13

**M**

MagFlow calibration function ..... I-5  
 MagFlow configuration functions ..... I-1  
 Maintenance ..... 7-1  
 Messages, error ..... 5-1  
 Monitor key  
   Monitor output ..... 4-17  
   Monitor secondary output ..... 4-18  
 Monitor key (AVS)  
   Air pressure ..... A-13  
   Deviation ..... A-13  
   Digital input ..... A-13  
   Input air supply (O1) ..... A-13  
   Output air supply ..... A-13  
   Output air supply (O2) ..... A-13  
   Position ..... A-13  
   Reverse ..... A-13  
   Temperature ..... A-13  
   Travel ..... A-13  
 Monitor output ..... 4-16, 4-17  
 Monitor secondary output ..... 4-18

**N**

Name, STT04 ..... 4-23, 4-24  
 New database ..... O-6  
 Nomenclature ..... 1-3

**O**

Open database ..... O-7  
 Operational functions ..... 4-11  
 Operator/interface controls ..... 4-1  
 Options and accessories ..... 1-4  
 Options key functions ..... 4-21  
   Battery charge ..... 4-22, 4-23, 4-24  
   Communications format ..... 4-22  
   Language ..... 4-21  
 Output key  
   Monitor output ..... 4-16  
   Temperature ..... 4-18

**P**

Physical operation ..... 2-1, 3-1  
 Point-to-point communication ..... 2-1  
 Problem codes, TB82 ..... N-17  
 PTH calibration procedures ..... D-5, P-5, 1-17  
 PTS calibration procedures ..... E-4

**R**

Recommended spare parts ..... 6-5  
 Reference documents ..... 1-3, E-1  
 Remote mode ..... O-9  
 Removing clip leads ..... 3-3  
 Replacement parts ..... 8-1  
 Report diagnostics ..... O-13  
 Rerange procedure ..... 4-19

**S**

Security ..... O-1  
 Set COM port ..... O-13  
 Spare parts  
   Recommended ..... 6-5  
   Replacement ..... 8-1  
 Special feature key ..... 4-12  
   Fix output/cancel fix output ..... 4-12  
   LCD setup ..... 4-13  
   Standard configuration ..... 4-14  
 Special handling ..... 6-1  
 Standard configuration ..... 4-14  
 Start utilities software ..... O-6  
 Status check ..... 4-19  
 STT04 cleaning ..... 7-1  
 STT04 name ..... 4-23, 4-24  
 STT04 upgrades ..... 6-4  
 Support services ..... 8-1

**T**

TB82 calibration procedures ..... N-4  
 TBN480  
   Calibration procedures ..... J-5  
   Reset to factory configuration ..... J-11  
 TBN580  
   Calibration procedures ..... K-5  
 TBN581  
   Calibration procedures ..... L-4  
 Technical documentation ..... 8-1  
 Temperature function ..... 4-18  
 Temperature limits ..... 1-4  
 Test communications ..... O-11  
 Training ..... 8-1

---

## Index (continued)

---

Transfer configurations ..... O-8  
Troubleshooting ..... 5-1  
TZID/AZH calibration procedures..... M-5

### U

Upgrade  
    Boot code ..... O-13  
    Firmware ..... O-13  
Upgrade firmware..... 6-3  
Upload configuration from STT04 ..... 4-25  
Utilities software ..... 4-25  
    Adding a user ..... O-1  
    Change STT04 name ..... O-12  
    Description ..... 3-4  
    Download to STT04..... O-10  
    Downloading configurations ..... 4-25  
    Exit ..... O-7  
    Installing ..... 3-4  
    New database ..... O-6  
    Open database..... O-7  
    Practices..... 3-4  
    Report diagnostics..... O-13

Security ..... O-1  
Set COM port ..... O-13  
Start ..... O-6  
Starting the password program..... O-1  
System requirements ..... 3-4  
Test communication..... O-11  
Transfer configuration ..... O-8  
Upgrade boot code ..... O-13  
Upgrade firmware ..... O-13  
Upload from STT04 ..... O-9  
User level accessibility..... O-3  
View files of a databases ..... O-8  
View STT04 configurations..... O-7

### V

View files of a database..... O-8

### W

Wiring  
    Field bus ..... 2-2  
    Point-to-point ..... 2-2, 3-3

PN25054



The Company's policy is one of continuous product improvement and the right is reserved to modify the information contained herein without notice.

© 2002 ABB Automation Inc.

Printed in USA

---

**ABB Inc.**  
Instrumentation Division  
125 East County Line Road  
Warminster, PA 18974 USA  
Tel. 215-674-6000  
FAX: 215-674-7183

**ABB Instrumentation Ltd**  
Howard Road, St. Neots  
Cams. England, PE19 3EU  
Tel. +44 (0) 1480-475-321  
FAX: +44 (0) 1480-217-948

**ABB Instrumentation S.p.A**  
Via Sempione 243  
20016 Pero (Milano) Italy  
Tel: +39 (02) 33928 1  
Fax: +39 (02) 33928 240

**ABB Automation Products GmbH**  
Industriestr. 28  
D-65760 Eschborn Germany  
Tel: +49 (0) 6196 800 0  
Fax: +49 (0) 6196 800 1849