

Power Supply CP-ASI/8.0

Primary switch mode power supply for AS-interface

The CP-ASI power supply range is specifically designed with integrated data decoupling for the supply of AS-Interface systems.

Up to 62 slaves (binary I/O devices) can be supplied with a single two-conductor cable.

The configurable IR addressing mode allows the easy assign of new ID addresses by means of an external infrared programming unit.



20DC271005S0012

Characteristics

- Rated output voltage 30.5 V DC
- Rated output current 8.0 A
- Rated output power 244 W
- Rated input voltage 115 or 230 V AC, configurable
- Infrared addressing mode
- High efficiency of up to 92 %
- Low power dissipation and low heating
- Free convection cooling (no forced cooling with ventilators)
- Ambient temperature range during operation -10...70 °C
- Open-circuit, overload and short-circuit stable, protected by integrated electronic fuse
- Integrated input fuse
- Tool-free mounting on DIN rail as well as demounting
- LEDs for the indication of operational states

Approvals



UL 508, CAN/CSA C22.2 No.107.1¹⁾



UL 60950-1, CAN/CSA C22.2 No. 60950-1¹⁾

¹⁾ Approvals refer to rated input voltage U_{in}

Marks



CE

Order data

Type	Input voltage range	Rated output voltage	Rated output current	Order code
CP-ASI/8.0	85-132 V AC 184-264 V AC	30.5 V DC	8.0 A	1SVR427090R0800

Functions



- 1 Input voltage selector**
Adjustment of input voltage
- 2 Indication of operational states**
OVERLOAD: red LED – overload
- 3 Reset button**
- 4 Circuit diagram**
- 5 Indication of operational states**
IR ADDRESSING ON: red LED – infrared addressing mode active
- 6 Configuration of operation mode**
Jumper
- 7 Indication of operational states**
AS-I OK: green LED – output voltage OK
- 8 Output**
+, -, +, -, SHIELD: terminals output
- 9 Input**
L, N, PE: terminals - input

Application

The primary switch mode power supply is specifically designed with integrated data decoupling for the supply of AS-interface systems. It operates at two selectable input voltage ranges and can be used worldwide, within compact dimensions. To protect the relatively thin wires of the AS-interface cable and the connected components, the output circuit features an electronic fuse, which permanently switches off the output in the event of a failure.

The easy-to-set front-face jumper allows the assignment of new ID addresses to slaves by means of an external infrared programming unit without disconnecting them from the AS-interface cable.

Up to 62 binary I/O devices can be connected and supplied according to the AS-interface bus technology with a single two-conductor cable. The communication signals are modulated onto the slaves' DC supply voltage of the AS-interface system, which therefore requires a specific power supply with integrated data decoupling.

Operating mode

By means of the input voltage selector the input voltage can either be set to 115 V AC or 230 V AC. The front-face jumper allows the configuration of the operation mode of the power supply, i.e. "1-2 COMMUNICATION MODE" or "2-3 IR ADDRESSING MODE" to either control and supply AS-interface slaves or to interrupt the data communication for the assignment of new ID addresses to slaves by means of an external infrared programming unit.

In the event of a failure, the integrated electronic fuse permanently switches off the output to prevent an accidental restart. The front-face button RESET allows the intentional reactivation of the power supply.

The green LED "AS-I OK" is on during normal operation, i.e. when the output voltage exceeds 30 V DC, and is off at overload.

The red LED "IR ADDRESSING ON" is on when data communication has been interrupted by means of the jumper.

The red LED "OVERLOAD" is flashing after having triggered the integrated electronic fuse of the output circuit in the event of overload, short circuit or overtemperature.

Installation

The device must be installed by qualified persons only and in accordance with the specific national regulations (e.g. VDE, etc.). The devices are maintenance-free chassis-mounted units.

Before installation



DANGER!

Components with high stored energy and circuits with high voltage

Danger to be electrocuted!

- ▶ Disconnect the system from the supply network and protect against switching on before any installation, maintenance or modification work.
- ▶ Do not introduce any objects into the unit and do not open the unit.
- ▶ Ensure that the service personnel is protected against inadvertent contact with parts carrying energy.

Mounting

The switch mode power supply can be snapped on a DIN rail (TH 35-15 or TH 35-7.5 according to IEC/EN 60715) as shown in the accompanying picture. For that the device is set with its mounting rail side on the upper edge of the mounting rail and locked by lifting it downwards.

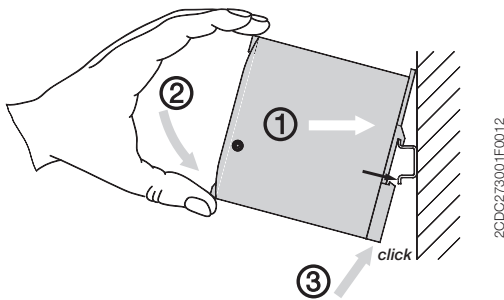

Demounting

Remove the switch mode power supply as shown in the accompanying picture. For that the latching lever is pulled downwards by means of the screwdriver. Alternatively the upperside of the latching lever can be pressed to release the device. Then in both cases the device can be unhinged from the mounting rail edge and removed.

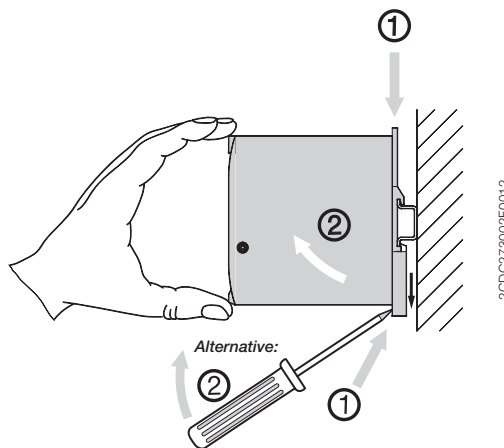

Mounting position

The devices have to be mounted horizontally with the input terminals on the bottom. In order to ensure a sufficient convection, the minimum distance to other modules should not be less than 15 mm (0.59 in) in vertical and 25 mm (0.98 in) horizontal direction.

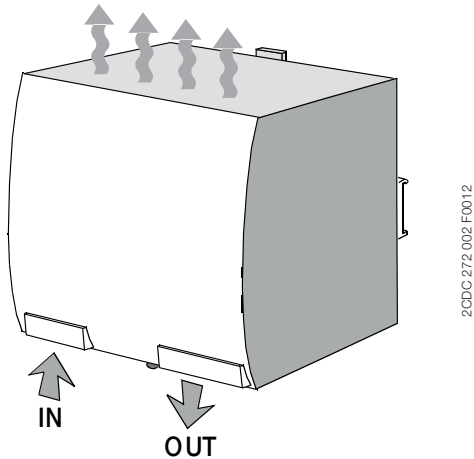

Electrical connection

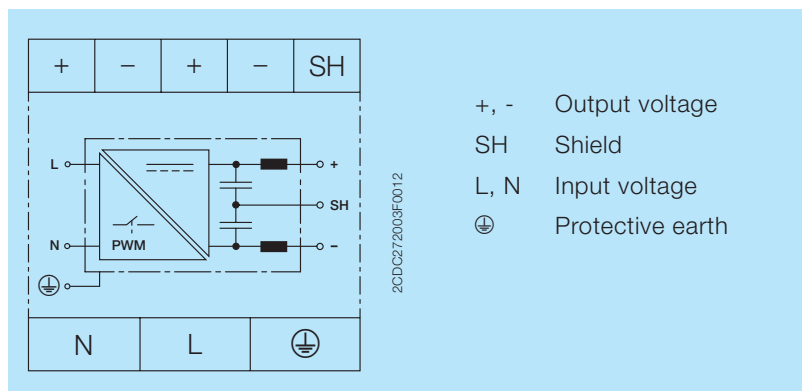

Preparations:

- Connect to mains according to the specific national regulations.
- Power supply cables and unit must be sufficiently fused. A disconnecting device has to be provided for the power supply to disengage unit and supply cables from supply mains if required.
- We recommend to choose the cable section as large as possible in order to minimize voltage drops.
- In order to ensure sufficient air-cooling the distance to other devices has to be considered.

Instructions:

1. Connect the input terminals L and N.
2. Connect the protective earth conductor to terminal ⊕ (protection class I).
3. Provide a suitable disconnecting device (e.g. line protection switch) in the supply line acc. to IEC/EN 60950-1.
4. Rate the lines for the maximum output current (considering the short-circuit current) or provide a separate fuse protection. The input side is protected by an internal input fuse.
5. Observe the polarity.

Connect the 'shield' terminal on the AS-i power supply to the machine ground so that the AS-i system is symmetrically operated against this machine ground. This improves noise sensitivity in case of symmetrical interference on the AS-i cable.

The device is overload, short-circuit and open-circuit proof. The secondary side of the power supply unit is electrically isolated from the input.

Operation



DANGER!

High current

Risk of electric arcs and electric shocks!

- ▶ Do not modify the installation (primary and secondary side).
- ▶ Intended use.



CAUTION!

Depending on the operation conditions the enclosure can become very hot

Risk of burns!

- ▶ In order to ensure sufficient air-cooling the distance to other devices has to be considered.

The device is intended for use as a primary switch mode power supply for AS-interface systems. Any other usage is not supported by the manufacturer. Other usage may impair safety and cause operational difficulties or destruction of the unit.

Service

The internal fuse is not user-replaceable. If the internal fuse blows, most probably the device is defective. In this case, an examination of the switch mode power supply by the manufacturer is necessary.

Technical data

Data at $T_a = 25\text{ °C}$, $U_{in} = 230\text{ V AC}$ and rated values, unless otherwise indicated

Input circuit – Supply circuit		L, N
Rated input voltage U_{in}	switch position 115 V	100-120 V AC
	switch position 230 V	220-240 V AC
Input voltage range	switch position 115 V	85-132 V AC
	switch position 230 V	184-264 V AC
Frequency range AC		47-63 Hz
Typical input current	switch position 115 V	6.0 A
	switch position 230 V	2.8 A
Typical power consumption		261 W
Inrush current limiting / I^2t (cold start)		< 12 A (100 V AC) / approx. 1.0 A ² /s
		< 14 A (120 V AC) / approx. 1.5 A ² /s
		< 24 A (220 V AC) / approx. 1.4 A ² /s
		< 27 A (240 V AC) / approx. 1.6 A ² /s
Discharge current towards PE		< 3.5 mA
Power failure buffering time	at 115 V AC	min. 20 ms
	at 230 V AC	min. 30 ms
Transient overvoltage protection		varistor
Internal input fuse		8 A slow acting / 250 V AC
External fusing (not necessary, but recommended)		circuit breaker with C characteristic min. 6 A, or alternatively 10 A with B characteristic
Power Factor Correction (PFC)	at 115 V AC	0.53
	at 230 V AC	0.48
Indication of operational states		
Output voltage	AS-I OK	LED green
IR addressing mode	IR ADDRESSING ON	LED red
Overload	OVERLOAD	LED red
Output circuit		+, -
Rated output power		244 W
Rated output voltage		30.5 V DC
Tolerance of the output voltage		± 3 %
Rated output current I_r	$T_a \leq 60\text{ °C}$	8.0 A
Derating of the output current	$60\text{ °C} < T_a \leq 70\text{ °C}$	2.5 % / °C
Control time		< 2 ms
Starting time after applying the supply voltage		max. 500 ms
Rise time		max. 100 ms
Residual ripple	BW = 500 kHz	typ. < 50 mV _{pp}
Switching peaks	BW = 20 MHz	typ. < 150 mV _{pp}
Output circuit – No-load, overload and short-circuit behaviour		
Characteristic curve of output		Combined U/I characteristic curve and hiccup mode
Short-circuit protection		temporary short-circuit stability
Current limiting at short circuit	min / max	12 A / 25 A (max. 5 s)
Overload protection		temporary output power limiting
Overtemperature, overload and short circuit behaviour		at 8.4 A < I_{max} < 12 A continuous current for 2-5 s, afterwards safety switch-off
No-load protection		continuous no-load stability

General data		
MTBF		on request
Power dissipation		typ. < 21.2 W (230 V AC, 8.0 A)
Efficiency		typ. 92 %
Duty time		100 %
Dimensions (W x H x D)	product dimensions	91 x 131 x 107 mm (3.58 x 5.16 x 4.21 in)
	packaging dimensions	151 x 120 x 140 mm (5.94 x 4.72 x 5.51 in)
Weight	net weight	0.897 kg (1.997 lb)
	gross weight	1.015 kg (2.238 lb)
Material of housing		metal
Mounting		DIN rail (IEC/EN 60715), snap-on mounting without any tool
Mounting position		horizontal
Minimum distance to other units	horizontal / vertical	15 mm / 25 mm (0.59 / 0.99 in)
Degree of protection	housing / terminals	IP 20
Protection class		I
Electrical connection		
Wire size	fine-strand with wire end ferrule	0.5-4 mm ² (20-12 AWG)
	fine-strand without wire end ferrule	0.5-4 mm ² (20-12 AWG)
	rigid	0.5-6 mm ² (20-10 AWG)
Stripping length		7 mm (0.28 in)
Tightening torque		0.8 Nm (7.08 lb.in)
Environmental data		
Ambient temperature ranges	operation	-10...+70 °C
	rated load	-10...+60 °C
	storage	-25...+85 °C
Vibration		2-17.8 Hz, amplitude ± 1.6 mm
	sinusoidal (IEC/EN 60068-2-6)	17.8 Hz - 500 Hz, 2 g
	random (IEC 60068-2-64)	2-800 Hz 0.5 s ² (s ³)
Shock, half-sine (IEC/EN 60068-2-27)		15 g (6 ms), 10 g (11 ms)
Isolation data		
Rated insulation voltage U _i (IEC/EN 60950-1, EN 50178)	input / output	300 V
	input / PE	300 V
	output / PE	50 V
	shield / output	50 V
	shield / PE	50 V
Rated impulse withstand voltage U _{imp} (EN 50178)	input / output	6 kV 1.2/50 µs
	input / PE	4 kV 1.2/50 µs
	output / PE	500 V 1.2/50 µs
Power-frequency withstand voltage test (test voltage) (routine test / type test)	input / output	2.5 kV AC / 3.0 kV AC
	input / PE	2.5 kV AC / 2.5 kV AC
	output / PE	500 V AC / 500 V AC
Pollution degree (IEC/EN 60950-1)		2
Overvoltage category (IEC/EN 60950-1, EN 50178)	input	II (IEC/EN 60950-1), III (EN 50178)
	output	II (IEC/EN 60950-1), II (EN 50178)
Standards / Directives		
Standards		IEC/EN 60950-1
Low Voltage Directive		2014/35/EU
Protective low voltage		SELV (IEC/EN 60950-1), PELV
EMC Directive		2014/30/EU
RoHS Directive		2011/65/EU

Electromagnetic compatibility		
Interference immunity to		IEC/EN 61000-6-2
electrostatic discharge	IEC/EN 61000-4-2	Level 4 (8 kV / 15 kV)
radiated, radio-frequency, electromagnetic field	IEC/EN 61000-4-3	Level 3 (10 V/m)
electrical fast transient/burst	IEC/EN 61000-4-4	input circuit: Level 4 (4 kV) output / signalling circuit: Level 3 (2 kV)
surge	IEC/EN 61000-4-5	input circuit: L-L Level 3 (2 kV) / L-PE Level 4 (4 kV) output circuit: Level 1 (0.5 kV)
conducted disturbances, induced by radio-frequency fields	IEC/EN 61000-4-6	Level 3 (10 V, 150 kHz - 80 MHz)
voltage dips, short interruptions and voltage variations	IEC/EN 61000-4-11	Class 3
Interference emission		IEC/EN 61000-6-4
high-frequency radiated	IEC/CISPR 22, EN 55022	Class B
high-frequency conducted	IEC/CISPR 22, EN 55022	Class B

Technical diagrams

Output behaviour

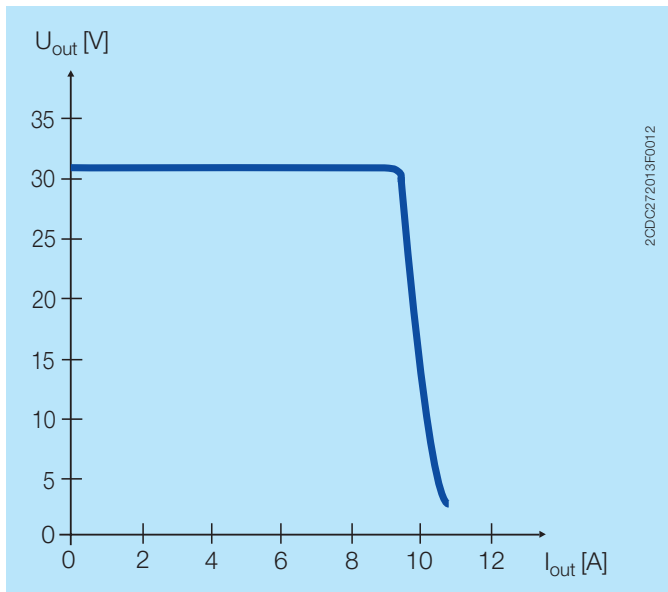

Characteristic curve of output at $T_a = 25$ °C

Temperature behaviour

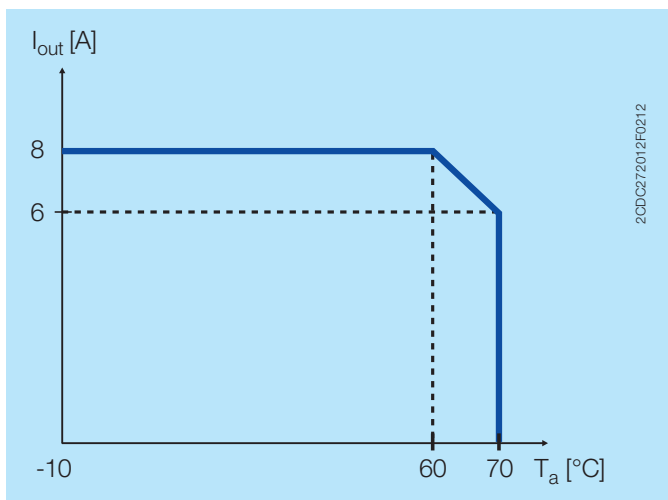

Characteristic curve of temperature at rated load

Dimensions

in **mm** and inches

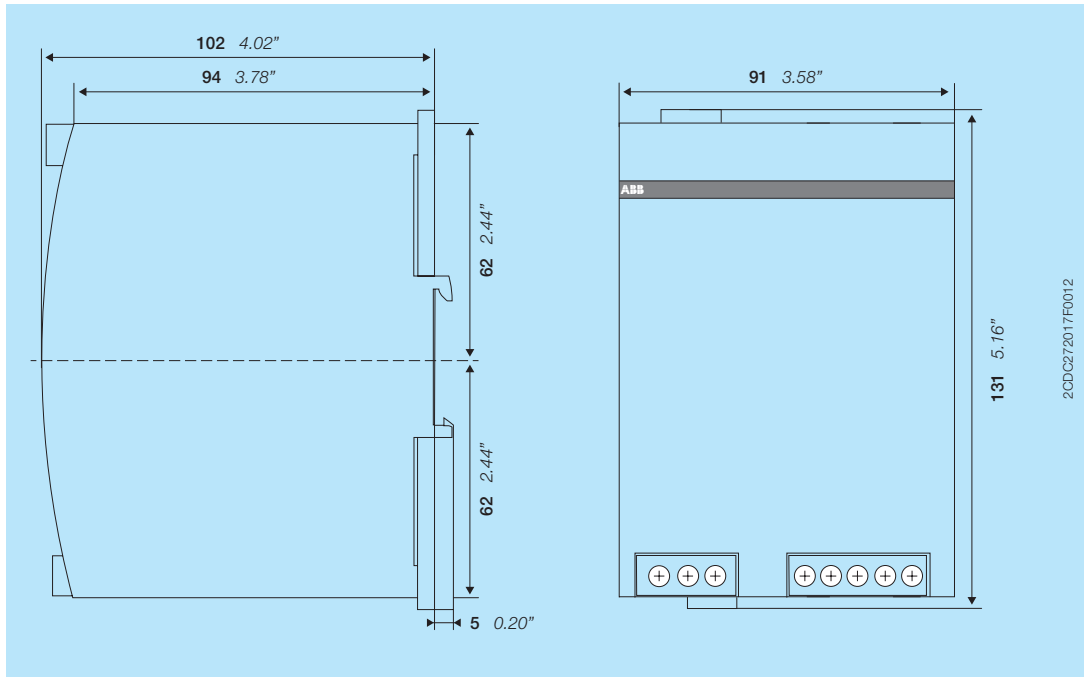

Further documentation

Document title	Document type	Document number
Electronic products and relays	Technical catalogue	2CDC 110 004 C02xx
Power supply units	Application manual	2CDC 114 048 M020x
CP-ASI/2.8, CP-ASI/4.0, CP-ASI/8.0	Instruction manual	1SVC 427 090 M0000

You can find the documentation on the internet at www.abb.com/lowvoltage
-> Automation, control and protection -> Power supplies.

CAD system files

You can find the CAD files for CAD systems at <http://abb-control-products.partcommunity.com>
-> Low Voltage Products & Systems -> Control Products -> Power Supplies.

Contact us

ABB STOTZ-KONTAKT GmbH

P. O. Box 10 16 80
69006 Heidelberg, Germany
Phone: +49 (0) 6221 7 01-0
Fax: +49 (0) 6221 7 01-13 25
E-mail: info.desto@de.abb.com

You can find the address of your
local sales organisation on the
ABB home page
<http://www.abb.com/contacts>
-> Low Voltage Products and Systems

Note:

We reserve the right to make technical changes or modify the contents of this document without prior notice. With regard to purchase orders, the agreed particulars shall prevail. ABB AG does not accept any responsibility whatsoever for potential errors or possible lack of information in this document.

We reserve all rights in this document and in the subject matter and illustrations contained therein. Any reproduction, disclosure to third parties or utilization of its contents – in whole or in parts – is forbidden without prior written consent of ABB AG.

Copyright© 2016 ABB
All rights reserved