



Motor starting with Soft starters – Reduced stresses

Soft Starting

Soft starting method of starting induction motor is one of excellent method where in substantial amount of stresses both mechanical and electrical are reduced. Complete motor starting sequence is done in smooth manner without any jerks. The construction of soft starters is with thyristors. With methodology of firing of thyristors, voltage ramp (linear variation of voltage from 0 to rated voltage). This ramp ensures smooth starting of motor with starting current limit. The soft starters give option various parameters that are site settable based on application.

There is some misconception that soft starters induce harmonics into network. However with bypass contactor will be in picture during continuous operation where current passes through contactor which is a least resistance path. Hence soft starters have no contribution towards the harmonics in the network.

The below table provides typical approximate starting time required depending on the type of load connected to motor shaft. The starting time also depends on type of starters.

	Approximate starting times		
	Direct on line	Star delta starter	Softstarter (ramp time 10 sec)
Motor without load 	0.2 – 0.5 sec	0.4 sec	1 sec
Motor connected to application with small flywheel (normal start) 	2 – 4 sec	3 – 6 sec	6 sec
Motor connected to application with large flywheel (heavy duty start) 	6 – 8 sec	8 – 12 sec	8 – 12 sec

The below table also provides typical problems faced during starting of induction motors with different types of starting methods. As you observe, with VFD most of the issues are eliminated. However when application does not call for change of speed of the motor, VFD becomes commercially not a viable solution.

Type of problem	Type of starting method			
	Direct on line	Star-Delta start	Drives	Softstarter
Slipping belts and heavy wear on bearings	No	Medium	Yes	Yes
High inrush current	No	Yes	Yes	Yes
Heavy wear and tear on gear boxes	No	No (at loaded start)	Yes	Yes
Damaged goods / products during stop	No	No	Yes	Yes
Water hammering in pipe system when stopping	No	No	Yes	Yes (Eliminated with Torque control Reduced with voltage ramp)
Transmission peaks	No	No	Yes	Yes

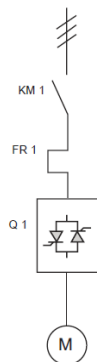

There are different methods of connecting soft starters with which cost optimization can be achieved.

- In-line connection
- Inside-delta connected

Typically inline type soft starters will have Power devices rated for line current.

However in case of inside-delta connection, Power devices are subjected to 58% of Line current ($1/\sqrt{3}$).

All performances of the soft starters will remain unaltered in both types except 6 cables requirement for motor connection in inside delta type.

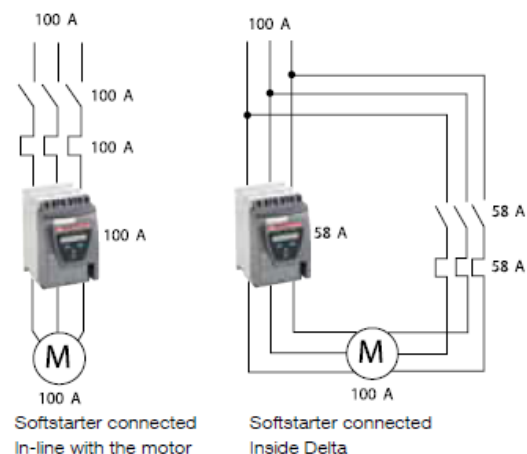

There are electrical and mechanical benefits one get with use soft starters in motor switching application. The curves below provide clear understanding on the benefits of soft starters.

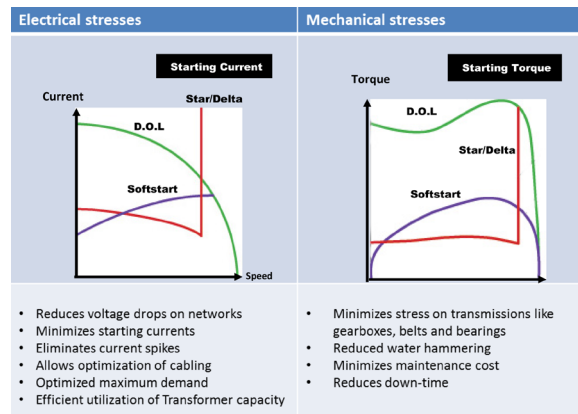

We will understand some of the important terms in soft starters which will help in selecting and sizing.

Voltage ramp

When using the voltage ramp, the voltage is increased linearly from the start level to full voltage during start. Since the torque depends on both the voltage and the current, the torque curve does not always follow the voltage curve. This has the effect that the torque curve will not increase or decrease linearly.

Torque ramp

When using the torque ramp, the output voltage to the motor is controlled so that the torque will follow a predefined optimal curve from the start level to full voltage during start. This has the benefit that the mechanical starting behavior of the equipment driven by the motor will be much softer than when using voltage ramp. With a torque ramp, it is not the voltage that is ramped up or down linearly, it is the torque. This is done by using a regulation loop where the torque is calculated by measuring both the voltage and the current. This torque is then compared to the required torque and the voltage is adjusted so that the torque is changed in the required way.

Torque limit

It is possible to limit the starting torque during start by setting this parameter. When the torque limit is reached, the output voltage stays stable until the torque falls below the limit, then the ramping continues. Limiting the torque will minimize stress and wear on the equipment driven by the motor.

Current limit

Current limit can be used in applications where a limited starting current is required or at a heavy-duty start when it is difficult to achieve a perfect start with the setting of the initial voltage and the start ramp only. When the current limit is reached, the soft starter will temporarily stop increasing the voltage until the current drops below the set limit, and then continues ramping up to full voltage.

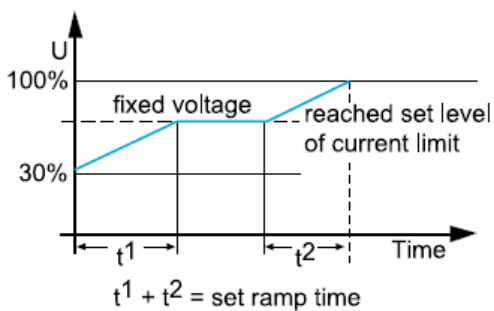

Holding the voltage at a fixed level will keep the current on the set level

ABB offers comprehensive portfolio of Soft starters for various applications.



We will explore further technological developments and benefits in soft starters in the upcoming technical journal.

Contact us

Toll-free number: 1800 420 0707

Email: lp.contactcenter@in.abb.com