

Operating Instructions Busch-AudioWorld®

MDRC amplifier 8208-500 Busch-AudioWorld®

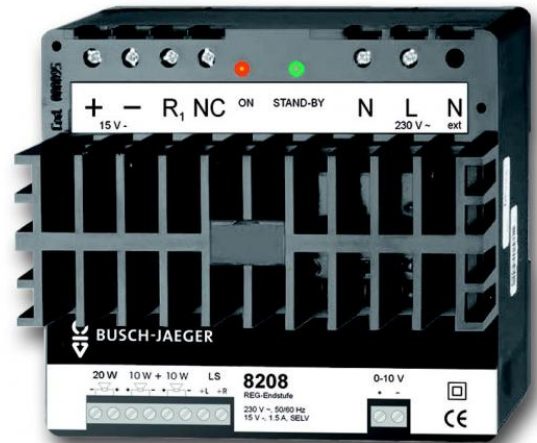

1	Safety.....	3
2	Intended use	3
	2.1 Environment.....	3
3	Technical data.....	4
4	Setup and function.....	4
	4.1 Features of function and equipment.....	4
	4.2 Possible combinations	5
5	Installation and electrical connection	6
	5.1 Requirements for the electrician	6
	5.2 General mounting instructions	7
	5.3 Mounting	7
	5.4 Electrical connection	8
	5.4.1 Connecting terminals and LED displays.....	8
	5.4.2 Installation / connection possibilities	9

1 Safety



Warning

Electric voltage!

Risk of death and fire due to electrical voltage of 230 V.

- Work on the 230V supply system may only be performed by authorised electricians!
- Disconnect the mains power supply prior to installation and/or disassembly!

2 Intended use

The device is part of the Busch-AudioWorld® system and is to be used exclusively with the components that are supplied and licensed as described in the "Structure and Function" chapter. The device must only be installed in dry indoor rooms.

2.1 Environment



Consider the protection of the environment!

Used electric and electronic devices must not be disposed of with domestic waste.

- The device contains valuable raw materials which can be recycled. Therefore, dispose of the device at the appropriate collecting depot.

All packaging materials and devices bear the markings and test seals for proper disposal. Always dispose of the packaging material and electric devices and their components via the authorized collecting depots and disposal companies.

The products meet the legal requirements, in particular the laws governing electronic and electrical devices and the REACH ordinance.

(EU Directive 2002/96/EC WEEE and 2002/95/EC RoHS)

(EU REACH ordinance and law for the implementation of the ordinance (EC) No.1907/2006)

3 Technical data

Designation	Value
Rated voltage	230 V AC, ±10%, 50 / 60 Hz
Supply current	1.5 A, 15 V, SELV
Output power	2 x 10 W or 1 x 20 W bridged
Loudspeaker impedance	2 – 16 ohm stereo 4 – 16 ohm mono
Number of loudspeakers	No. 8222 EB 8224 EB in parallel operation <ul style="list-style-type: none"> • Mono 4 units • Stereo 2 x 8 units
Mounting method	DIN rail: (VDE 50022)
Cable cross-section top	2 wires each with max. 6 mm ²
Cable cross-section bottom	2 wires each with max. 4.5 mm ²
Protection type	IP 20
Temperature range	5 °C ... 40 °C
Dimensions	7 TE à 18 mm
Line type audio bus	J-Y(ST)Y n x 2 x 0.8









4 Setup and function

4.1 Features of function and equipment

The MDRC amplifier is used when the power output of the Busch-Audioworld® is not adequate and needs to be raised, e.g. for larger rooms.

It is also used when an independent public address system is planned.

4.2 Possible combinations

	 8208-500	 8208-500
 1751-2x	X	X
 1751-7x	X	X
 1751-8x	X	X
 2147 U-x	X	X
 8210 U	X	X
 8211 U	X	

5 Installation and electrical connection



Warning

Electric voltage!

Risk of death due to electrical voltage of 230 V during short-circuit in the low-voltage line.

- Low-voltage and 230 V lines must not be installed together in a flush-mounted socket!

5.1 Requirements for the electrician



Warning

Electric voltage!

Install the device only if you have the necessary electrical engineering knowledge and experience.

- Incorrect installation endangers your life and that of the user of the electrical system.
- Incorrect installation can cause serious damage to property, e.g. due to fire.

The minimum necessary expert knowledge and requirements for the installation are as follows:

- Apply the "five safety rules" (DIN VDE 0105, EN 50110):
 1. Disconnect from power;
 2. Secure against being re-connected;
 3. Ensure there is no voltage;
 4. Connect to earth and short-circuit;
 5. Cover or barricade adjacent live parts.
- Use suitable personal protective clothing.
- Use only suitable tools and measuring devices.
- Check the supply network type (TN system, IT system, TT system) to secure the following power supply conditions (classic connection to ground, protective earthing, necessary additional measures, etc.).

5.2 General mounting instructions

- Terminate all branches of the wiring system via a connected bus device (e.g., indoor station, outdoor station, system device).
- Do not install the system controller directly next to the bell transformer and other power supplies (to avoid interference).
- Do not install the lines of the system bus together with 230 V- lines.
- Do not use common cables for the connecting wires of the door openers and wires of the system bus.
- Avoid bridges between different cable types.
- Use only two wires for the system bus in a four-core or multi-core cable.
- When looping, never install the incoming and outgoing bus inside the same cable.
- Never install the internal and external bus inside the same cable.

5.3 Mounting

The MDRC must only be installed on mounting rails according to DIN EN 500022. The MDRC is latched onto the mounting rail.

5.4 Electrical connection

5.4.1 Connecting terminals and LED displays

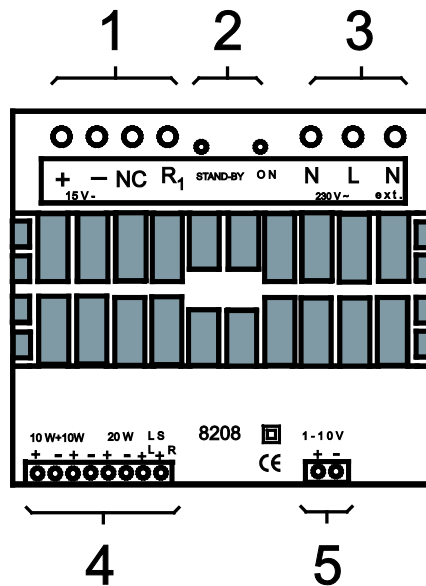

1 System bus | 2 LED displays | 3 Power supply | 4 Loudspeaker | 5 ?????

System bus

Designation	Assignment
N ext.	Neutral conductor when operating without 8201 / 8202
R 1	Signal input from audio bus (right channel 1)
NC	Supporting terminal (nc)
L +/-	Signal input (controlled)

LED displays

No.	Assignment
ON	Lights during operation
STANDBY	Mute can be activated only by a music signal.

Power supply

No.	Assignment
N	230 V AC, ±10%, 50 / 60 Hz
L	

Loudspeaker

No.	Assignment
10 W + 10 W	
20 W	
LS: +L / +R	Loudspeaker: right / left

?

Designation	Assignment
1 – 10 V	

5.4.2 Installation / connection possibilities

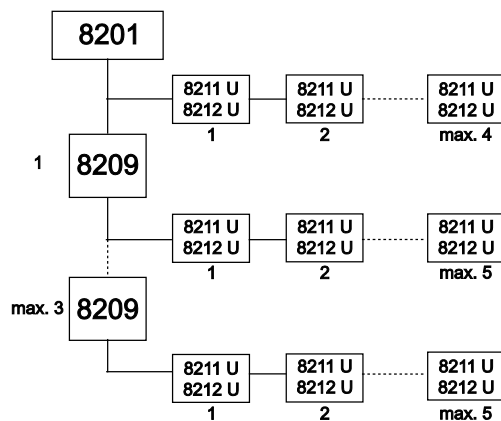

Fig. 1: Circuit diagram

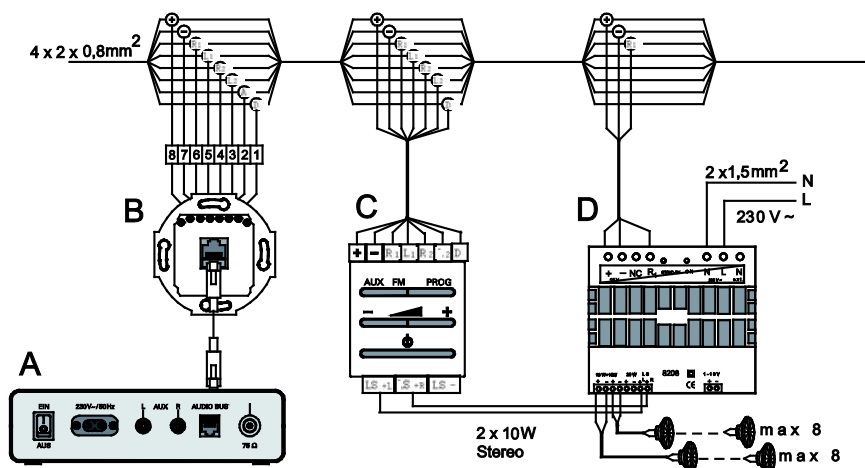

Fig. 2: Installations / connection possibilities

	Devices
A	8201 / 8202
B	0213
C	8211 U
D	8208-500

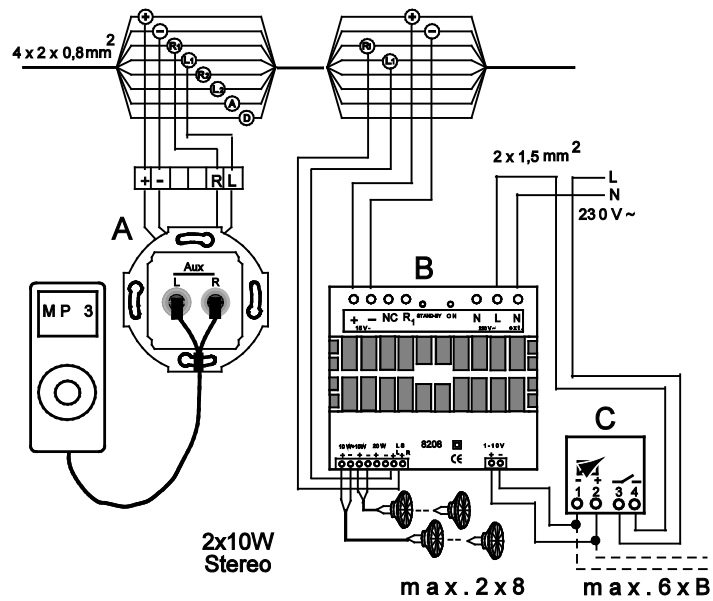

Fig. 3: Installations / connection possibilities

	Devices
A	8210 U
B	8208-500
C	Potentiometer 2112 / 6550

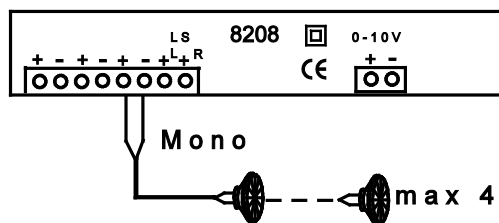

Fig. 4: Mono mode

A member of the ABB Group

Busch-Jaeger Elektro GmbH

PO box
58505 Lüdenscheid

Freisenbergstraße 2
58513 Lüdenscheid
Germany

www.BUSCH-JAEGER.com

info.bje@de.abb.com

Central sales service:

Phone: +49 (0) 2351 956-1600

Fax: +49 (0) 2351 956-1700

Notice

We reserve the right to at all times make technical changes as well as changes to the contents of this document without prior notice.

The detailed specifications agreed to at the time of ordering apply to all orders. ABB accepts no responsibility for possible errors or incompleteness in this document.

We reserve all rights to this document and the topics and illustrations contained therein. The document and its contents, or extracts thereof, must not be reproduced, transmitted or reused by third parties without prior written consent by ABB.

Copyright© 2012 Busch-Jaeger Elektro GmbH
All rights reserved