



5SDD 14F6000

Old part no. DV 808-1360-60

High Voltage Diode

Properties

- Low forward voltage drop
- Low recovery charge
- High operating temperature
- Low leakage current

Applications

- Rectifier bridges

Key Parameters

V_{RRM}	=	6 000	V
I_{FAVm}	=	1 363	A
I_{FSM}	=	17 500	A
V_{TO}	=	1.015	V
r_T	=	0.407	mΩ

Types

	V_{RRM}
5SDD 14F6000	6 000 V
Conditions:	$T_j = -40 \div 150 \text{ }^\circ\text{C}$, half sine waveform, $f = 50 \text{ Hz}$

Mechanical Data

F_m	Mounting force	22 ± 2	kN
m	Weight	0.46	kg
D_s	Surface creepage distance	30	mm
D_a	Air strike distance	20.5	mm

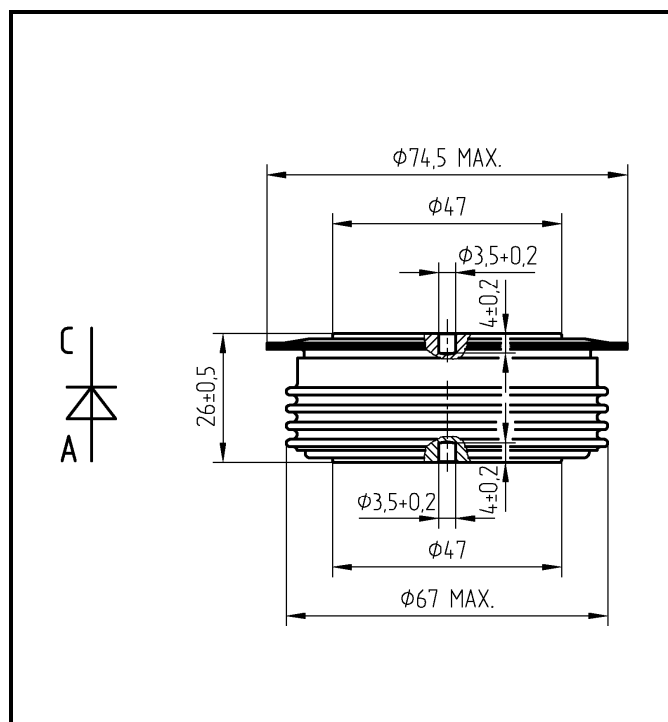

Fig. 1 Case



ABB s.r.o.

Novodvorska 1768/138a, 142 21 Praha 4, Czech Republic

tel.: +420 261 306 250, <http://www.abb.com/semiconductors>

Maximum Ratings		Maximum Limits	Unit	
V_{RRM}	Repetitive peak reverse voltage $T_j = -40 \div 150 \text{ }^\circ\text{C}$	6 000	V	
I_{FAVm}	Average forward current $T_c = 85 \text{ }^\circ\text{C}$	1 363	A	
I_{FRMS}	RMS forward current	2 142	A	
I_{RRM}	Repetitive reverse current, $V_R = V_{RRM}$	75	mA	
I_{FSM}	Non repetitive peak surge current $V_R = 0 \text{ V, half sine pulse, } T_j = 25 \text{ }^\circ\text{C}$	$t_p = 8.3 \text{ ms}$	20 300	A
		$t_p = 10 \text{ ms}$	19 000	A
	Non repetitive peak surge current $V_R = 0 \text{ V, half sine pulse}$	$t_p = 8.3 \text{ ms}$	18 700	A
		$t_p = 10 \text{ ms}$	17 500	A
I^2t	Limiting load integral $V_R = 0 \text{ V, half sine pulse, } T_j = 25 \text{ }^\circ\text{C}$	$t_p = 8.3 \text{ ms}$	1 710 000	A²s
		$t_p = 10 \text{ ms}$	1 805 000	A²s
	Limiting load integral $V_R = 0 \text{ V, half sine pulse}$	$t_p = 8.3 \text{ ms}$	1 450 000	A²s
		$t_p = 10 \text{ ms}$	1 531 250	A²s
$T_{jmin} - T_{jmax}$	Operating temperature range	-40 \div 150	$^\circ\text{C}$	
T_{STG}	Storage temperature range	-40 \div 150	$^\circ\text{C}$	

Unless otherwise specified $T_j = 150 \text{ }^\circ\text{C}$

Characteristics		Value			Unit
		min	typ	max	
V_{T0}	Threshold voltage $I_{F1} = 2\,142 \text{ A, } I_{F2} = 6\,425 \text{ A}$			1.015	V
r_T	Forward slope resistance			0.407	mΩ
V_{FM}	Maximum forward voltage $I_{FM} = 4\,000 \text{ A}$			2.68	V
Q_{rr}	Recovered charge $V_R = 100 \text{ V, } I_{FM} = 1\,000 \text{ A, } di_F/dt = -10 \text{ A}/\mu\text{s}$		3 000	4 000	μC

Unless otherwise specified $T_j = 150 \text{ }^\circ\text{C}$

Thermal Parameters			Value	Unit
R_{thjc}	Thermal resistance junction to case	double side cooling	20	K/kW
		anode side cooling	34	
		cathode side cooling	48	
R_{thch}	Thermal resistance case to heatsink	double side cooling	5	K/kW
		single side cooling	10	

Transient Thermal Impedance

Analytical function for transient thermal impedance

$$Z_{thjc} = \sum_{i=1}^4 R_i (1 - \exp(-t / \tau_i))$$

Conditions:
 $F_m = 22 \pm 2$ kN, Double side cooled

i	1	2	3	4
R_i (K/kW)	11.83	4.26	1.63	2.28
τ_i (s)	0.432	0.071	0.01	0.0054

Fig. 2 Dependence transient thermal impedance junction to case on square pulse

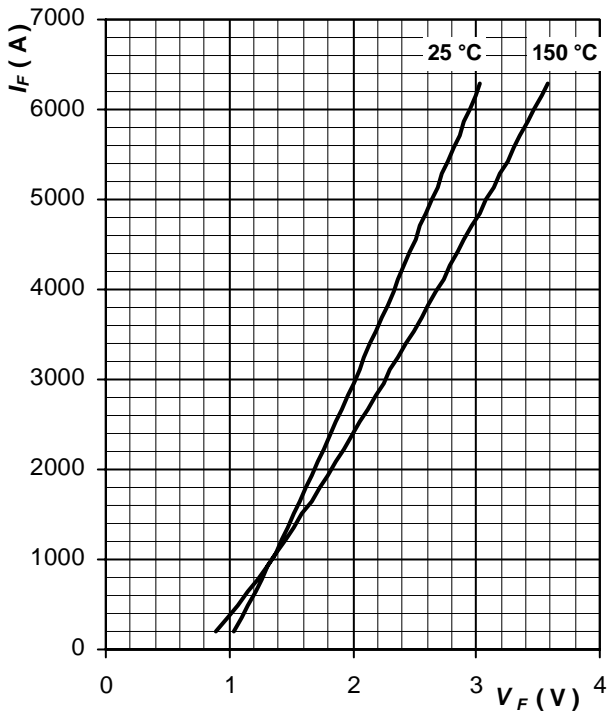

Fig. 3 Maximum forward voltage drop characteristics

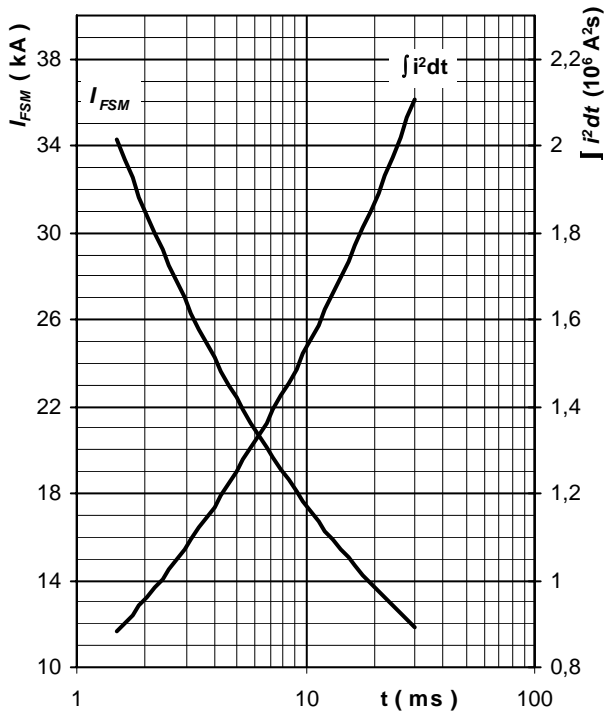

Fig. 4 Surge forward current vs. pulse length, half sine wave, single pulse, $V_R = 0 V$, $T_j = T_{jmax}$

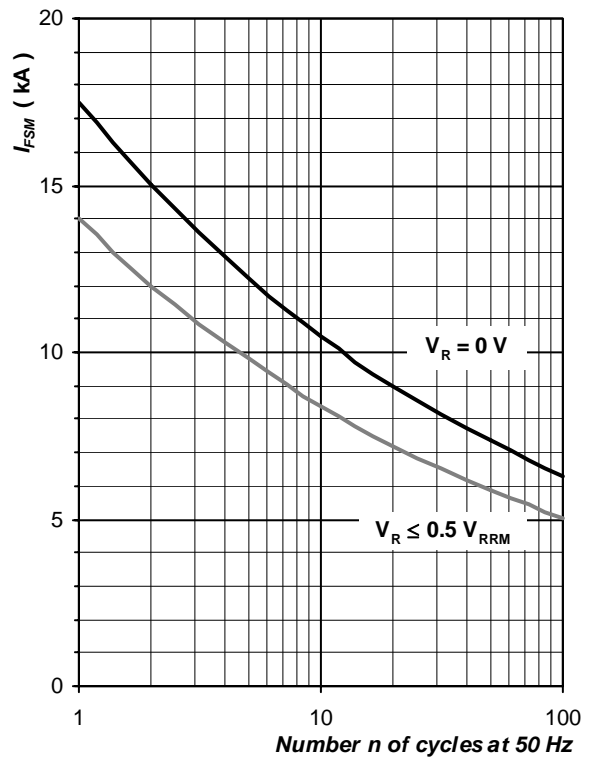

Fig. 5 Surge forward current vs. number of pulses, half sine wave, $T_j = T_{jmax}$

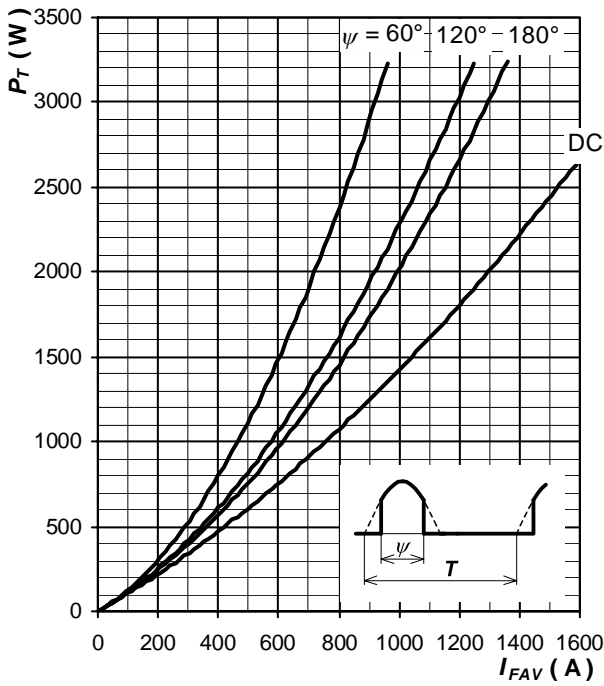

Fig. 6 Forward power loss vs. average forward current, sine waveform, $f = 50 \text{ Hz}$, $T = 1/f$

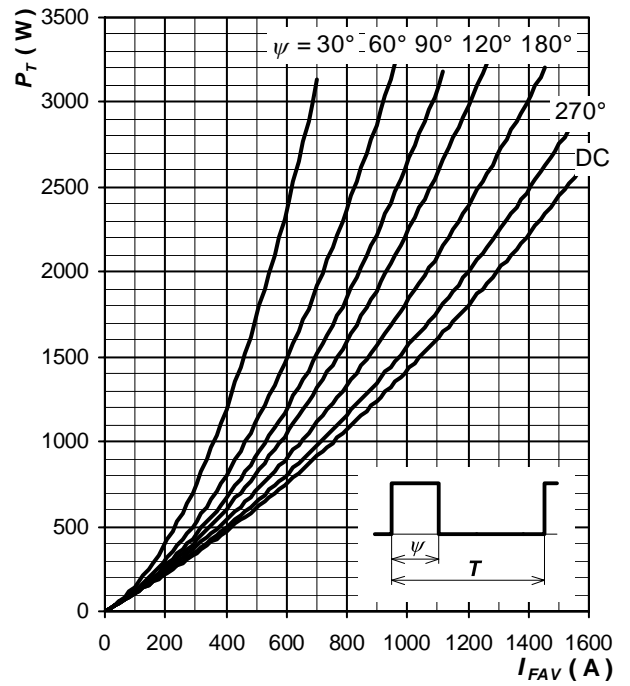

Fig. 7 Forward power loss vs. average forward current, square waveform, $f = 50 \text{ Hz}$, $T = 1/f$

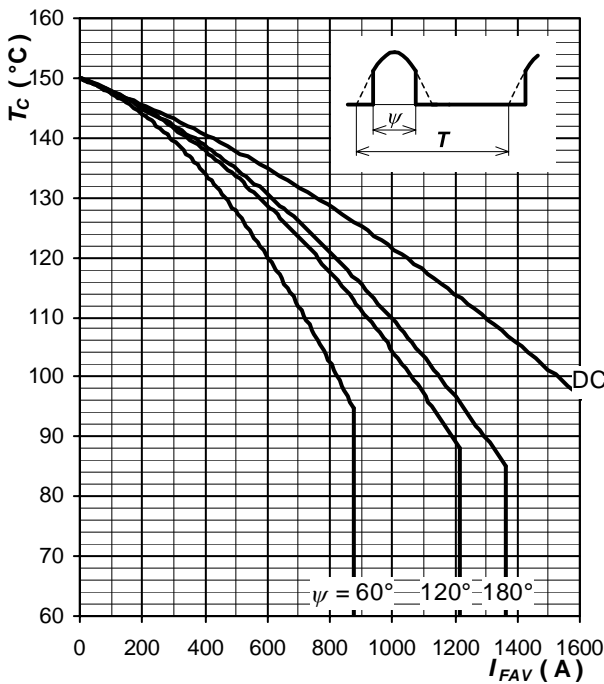

Fig. 8 Max. case temperature vs. aver. forward current, sine waveform, $f = 50 \text{ Hz}$, $T = 1/f$

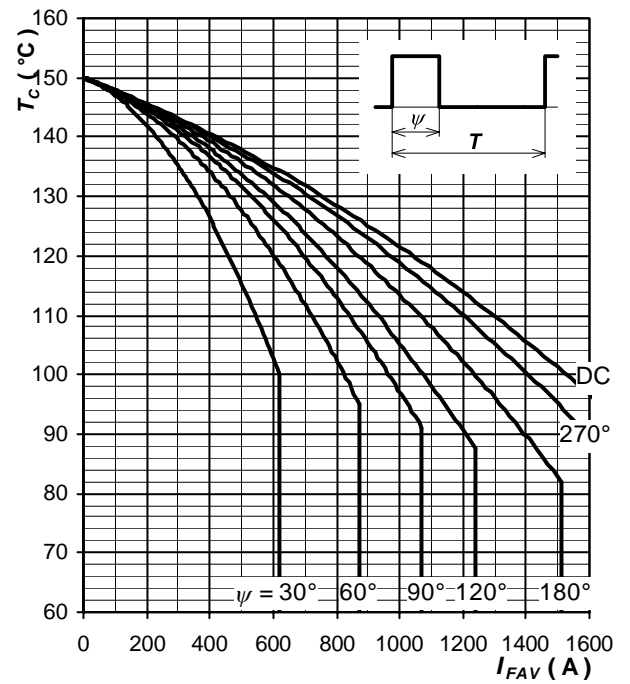

Fig. 9 Max. case temperature vs. aver. forward current, square waveform, $f = 50 \text{ Hz}$, $T = 1/f$

Notes: