



## ***8000-Line/Spectra Motor Control Center***

Renewal Parts Bulletin





# 8000-Line/Spectra Motor Control Center

## Introduction

The 8000-Line motor control center, a quality product of the General Electric Company, has been designed and manufactured to give long and satisfactory service. This Renewal Parts Bulletin contains items which, through normal use, may require periodic maintenance and replacement. Other items may never need service or replacement during the useful life of the equipment.

We feel that you are in the best position to determine your investment in Renewal Parts, taking into consideration the total amount of 8000-Line motor control centers at your facility, your proximity to General Electric franchised distributors, and the importance of minimizing equipment downtime.

For identifying and ordering replacement parts not included in this publication, refer to the “Spares Recommendation” and “Parts List” section of the renewal parts quotation for your motor control center. If this is not available, identify the equipment as follows before contacting your local distributor or General Electric sales office:

1. Equipment-GE 8000-Line motor control center
2. Complete vertical section nameplate information (for structural and bus parts)
3. Complete plug-in unit nameplate information (for individual unit parts)

Introduction .....	2
Ordering Instruction .....	3
Structural Parts .....	4-9
Vertical & Main Bus Parts .....	10-14
Unit Parts .....	14-29
Handle/Handle Assembly .....	17-21
Branch Overcurrent Protective Devices .....	22
Fusible Disconnect Switch .....	23-24
Control Power Transformer .....	24
Control Terminal Board .....	25
Slider Assembly (Inner-Outer) .....	25
Pilot Device Bracket Escutcheon .....	25
Overload Reset Assembly.....	25
Vertical Ground Bus Stab Finger .....	26
Pilot Device (Type CR104P) .....	26
Unit Nameplate (Blank) .....	26
Power Terminal Board.....	26
Harnesses .....	27
Torque Table.....	28





## 8000-Line/Spectra Motor Control Center Ordering Instructions

The ordering of renewal parts or complete unit replacements will be simplified by referencing the data provided on the 8000-Line motor control center section nameplate and, if required, unit nameplate.

**GENERAL ELECTRIC**  
8000 LINE CONTROL CENTER

CAT. NO.

DIAGRAM NO.

AMPS SUPPLY  SECT.  SECT.

VOLTS  PHASE  WIRE  HZ

Section Nameplate (located on the front of each UL listed section, near the upper right-hand corner)

**GENERAL ELECTRIC**  
8000 LINE CONTROL CENTER

CAT. NO.

DIAGRAM NO.

AMPS SUPPLY  SECT.  SECT.

VOLTS  PHASE  WIRE  HZ

Unit Nameplate (plug-in units-located on the right-hand vertical side barrier; Bolt-in units located in close proximity to the branch circuit overcurrent protective device)

CAT. NO.*	The General Electric, Mebane, N.C., factory catalog number
DIAGRAM NO.*	The outline summary sheet (often referred to as “record drawings”) for this section
AMPS-SUPPLY	The main (i.e. horizontal) bus rating
AMPS-SECTION	The vertical bus rating

When ordering replacement parts not identified in this bulletin, both the “CAT. NO.” and “DIAGRAM NO.” must be referenced, accompanied by a complete description of the replacement part(s) desired.

MODEL	Type of motor control center design
VOLTS TYPE	Unit power supply voltage. Unit function (as listed on outline-l summary sheet)
CONT. VOLTS	Unit control voltage.
UNIT NO.	The factory catalog number; this identifies the section and unit location within that section
DIAGRAM	The outline summary sheet and page number which contains the wiring elementary diagram for this unit
SIZE AMPS/HP	The NEMA size rating of the starter. The ampere rating of the circuit breaker or fusible switch (for feeder unit), or horsepower rating (for combination starter units)

When ordering a complete replacement unit or replacement parts not identified in this bulletin, the “MODEL”, “UNIT NO.”, and “DIAGRAM” must be referenced, accompanied by a complete description of the replacement part(s) desired.

**\* This information must be included on the order form.**





# 800-Line/Spectra Motor Control Center

## Structural Parts

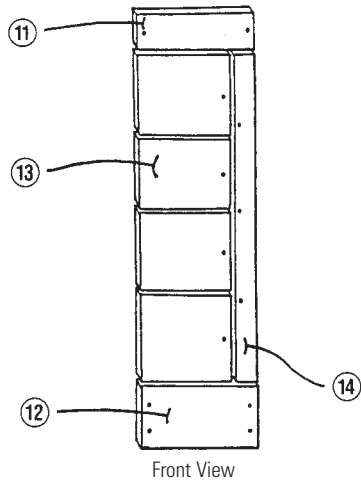

Front View

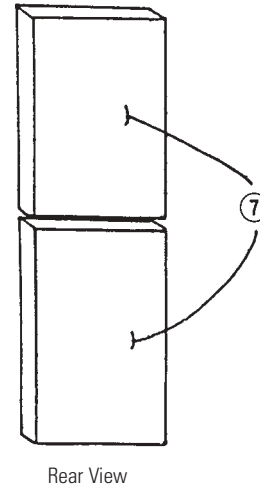

Rear View

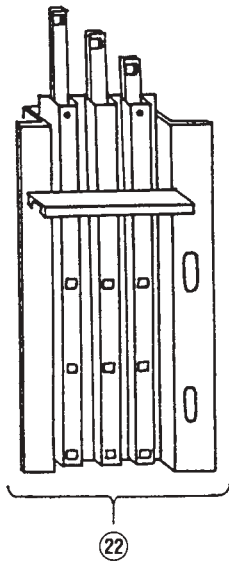
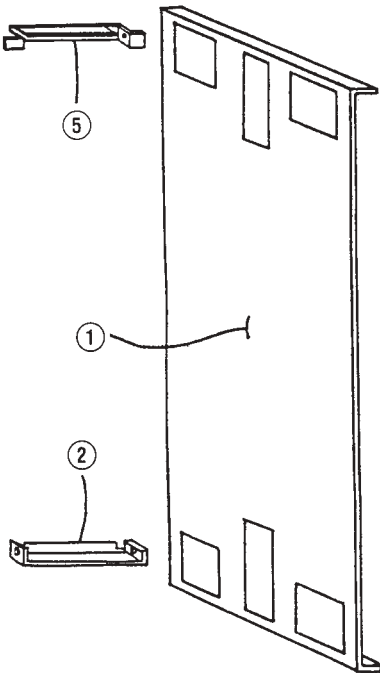
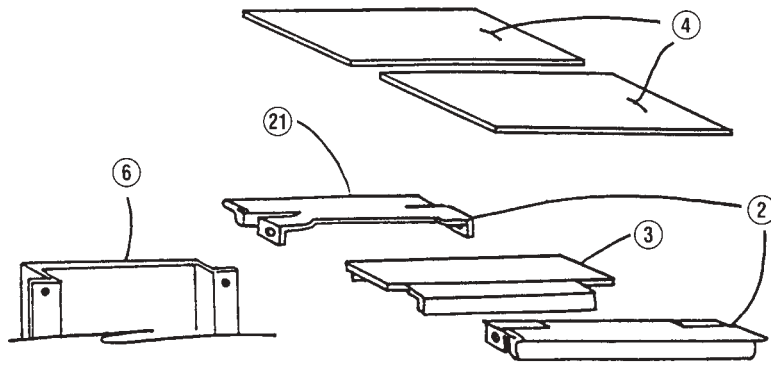

Exploded View

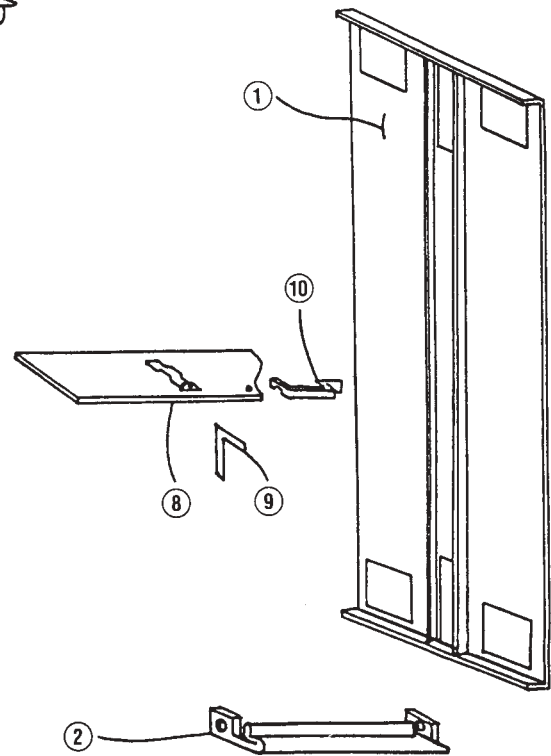



## 8000-Line/Spectra Motor Control Center Structural Parts



Item 1



Item 2



Item 5



Item 7



Item 3



Item 6



Item 4

Item	Description 8000 & Spectra	When Used	Cat. No.
1	Side Assembly	13-inch deep section	68J210377BBXX90XXB
		20-inch deep section	68J210377AB2090XXB
2	Case Sill	20-inch wide section	68J110304AB20XXXXB
		24-inch wide section	68J110304AB24XXXXB
3	Horizontal Channel	20-inch wide section	68J110305AB20XXXXB
		24-inch wide section	68J110305AB24XXXXB
4	Top Plate	20-inch wide section	68J110311AB2020XXB
		24-inch wide section	68J110311AB2024XXB
5	Rear Mullion	13-inches deep x 20-inches wide	68J110307AB20XXXXB
		13-inches deep x 20-inches wide	68J110307AB24XXXXB
		20-inches deep x 20-inches wide	68J110306AB20XXXXB
		20-inches deep x 24-inches wide	68J110306AB24XXXXB
6	Rear Main Bus Barrier 2"	20-inches wide	117B5088AEG20
		24-inches wide	117B5088AEG24
	Rear Main Bus Barrier 4"	20-inches wide	68J120315HY0102AFB
		24-inches wide	68J121950RQ0102AFB
7	Rear Cover 13" Deep	20-inches wide	68J120323LE0102AAB
		24-inches wide	68J120323XA0102AAB
	Rear Door Assembly 20" Deep	20-inches wide	68J210375DB2090XXB
		24-inches wide	68J210375DB2490XXB
7a (Not Shown)	Bottom Plate Note, Insert Section Width in inches (i.e., 20 or 24)	13-inch deep section	68J110312AB**XXXXB
		20-inch deep section, front	68J110312AC**XXXXB
		20-inch deep section, rear	68J110312AD**XXXXB





## 8000-Line/Spectra Motor Control Center Structural Parts



Item 8



Item 10



Item 9



Item 11

Item	Description 8000 & Spectra	When Used	Cat. No.
8	Shelf Assembly	Standard	68J210383BBXXXXXX
		Top Shelf Only	68J210383ABXXXXXX
9	Shelf Support Bracket	Bottom	117B5044P2
10	Shelf Extender	20-inch wide section	205A7680P20
		24-inch wide section	205A7680P24
11	8000 Line Wireway Cover with GE Logo	6-inches high x 20-inches wide	204B4127G1
		12-inches high x 20-inches wide	204B4127G2
		18-inches high x 20-inches wide	204B4127G3
		6-inches high x 24-inches wide	204B4127G4
		12-inches high x 24-inches wide	204B4127G5
		18-inches high x 24-inches wide	204B4127G6
	Spectra Wireway Cover with GE Logo	6-inches high x 20-inches wide	204B4178G7
		6-inches high x 24-inches wide	204B4178G4
		6-inches high x 30-inches wide	204B4178G1
		12-inches high x 20-inches wide	204B4178G2
		12-inches high x 24-inches wide	204B4178G5
		12-inches high x 30-inches wide	204B4178G8
		18-inches high x 20-inches wide	204B4178G3
		18-inches high x 30-inches wide	204B4178G9





## 8000-Line/Spectra Motor Control Center Structural Parts



Item	Description 8000 & Spectra	When Used	Cat. No.
12	8000 & Spectra Wireway Cover Without GE Logo	6-inches high x 20-inches wide	204B4127G19
		12-inches high x 20-inches wide	204B4127G20
		18-inches high x 20-inches wide	204B4127G21
	8000 & Spectra Wireway Cover without GE Logo	6-inches high x 24-inches wide	204B4127G22
		12-inches high x 24-inches wide	204B4127G23
		18-inches high x 24 inches wide	204B4127G24
13	8000 Line Filler Kit Assembly <sup>①</sup> (Not Shown)	6-inches high	204B4145AMG1
		12-inches high	204B4145AMG2
		18-inches high	204B4145AMG3
		24-inches high	204B4145AMG4
		30-inches high	204B4145AMG5
		36-inches high	204B4145AMG6
		42-inches high	204B4145AMG7
14	8000 Line Blank Door (15-inches wide) See Item 13	6-inches high	68J210395BAXX06XXB
		12-inches high	68J210395BAXX12XXB
		14-inches high	68J210395BAXX14XXB
		18-inches high	68J210395BAXX18XXB
		24-inches high	68J210395BAXX24XXB
		30-inches high	68J210395BAXX30XXB
		42-inches high	68J210395BAXX42XXB
		48-inches high	68J210395BAXX48XXB
14a	8000 & Spectra Wire-through Door Assembly (NotShown)	*Insert height of door in inches; 6-inch increments only, from 06 to 72.	68J210375CB20**XXB

<sup>①</sup> Includes blank door, shelf, shelf support and hinged filler strip. Referred to as a "space".





## 8000-Line/Spectra Motor Control Center Structural Parts

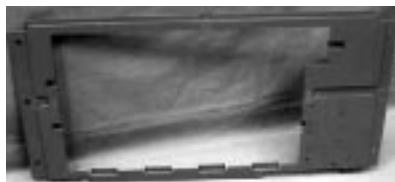

Item 15

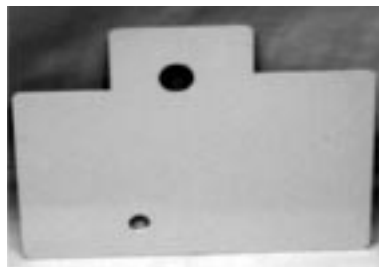

Item 17



Item 16



Item 17a Assembled View

Item	Description 8000 & Spectra	When Used	Cat. No.
15	Main Bus Barrier Slide Channel Guide	For Upper & Lower Slide Channels	169C6389BLP1
16	Bus Barrier (Left Hand)	2-inch main bus	204B4050WFP1
		4-inch main bus	68J120105WE0000AAN
17	Bus Barrier (Right Hand)	2-inch main bus	204B4050WEP1
		4-inch main bus	68J120105WF0000AAN

Item	Description 8000 & Spectra	Cat. No.
18	Latch Assembly, 1/4 Turn (Wire-through Door) (Not Shown)	169C06386DMG2
19	Cable Support (For Vertical Wire Harness) (Not Shown)	273A7819P1
20	Caplug (To Close Holes in Side of Section) (Not Shown)	204B4139AAG4 (Qty 5)
21	Lintel (13-inches deep only)	68J110308AB20XXXXB 20-inches wide
		68J110308AB24XXXXB 24-inches wide
22	Vertical Bus Assembly	Refer to page 10
23	End Cover Plate (Not Shown)	68J121950NF0000AAB 13-inches deep
		68J120315LF0000AAB 20-inches deep
24	Floor Channel (Not Shown)	205A3576P1A 20-inch single section
		205A3576P1E 24-inch single section
25	Grommet 5 x 5 " Cutout (Not Shown)	169C6386CYP1
26	Hinge Bracket (Right Hand) (Not Shown)	117B5027P3
27	Hinge Bracket Screw (Not Shown)	204B4139AAG15 (Qty 5)
28	Stub Shelf (Not for Plug-in Use) (Not Shown)	68J121379BB20XXXXB
29	Touch-up Spray Paint, ANSI-61 (Light Gray) (Not Shown)	TSP61







## 8000-Line/Spectra Motor Control Center Structural Parts

### *Spectra Series Structural Parts*

<b>Part</b>	<b>Description</b>	<b>Cat. No.</b>
Filler Kit – Spectra Line	6-inch	204B4145AMG1S
	12-inch	204B4145AMG2S
	18-inch	204B4145AMG3S
	24-inch	204B4145AMG4S
	30-inch	204B4145AMG5S
	36-inch	204B4145AMG6S
	42-inch	204B4145AMG7S
	48-inch	204B4145AMG8S
Blank Spectra Door	6-inch	68J210397DAXX06XXB
	12-inch	68J210397DAXX12XXB
	18-inch	68J210397DAXX18XXB
	24-inch	68J210397DAXX24XXB
	30-inch	68J210397DAXX30XXB
	36-inch	68J210397DAXX36XXB
	42-inch	68J210397DAXX42XXB
	48-inch	68J210397DAXX48XXB
Spectra Fill Strip	6-inch	275A5650BVP9
	12-inch	275A5650BVP10
	18-inch	275A5650BVP11
	24-inch	275A5650BVP12
	30-inch	275A5650BVP13
	36-inch	275A5650BVP14
	42-inch	275A5650BVP15
	48-inch	275A5650BVP16
Door Hinges	Spectra Hinge	204B4145FZP1
	Spectra Hinge Pin	273A7728TLP1
Wire Trough Doors	6-inch	68J210397AC2006XXB
	12-inch	68J210397AC2012XXB
	18-inch	68J210397AC2018XXB
	24-inch	68J210397AC2024XXB
	30-inch	68J210397AC2030XXB
	36-inch	68J210397AC2036XXB
	42-inch	68J210397AC2042XXB
	48-inch	68J210397AC2048XXB
	54-inch	68J210397AC2054XXB
	60-inch	68J210397AC2060XXB
	66-inch	68J210397AC2066XXB
72-inch	68J210397AC2072XXB	





## 8000-Line/Spectra Motor Control Center

### Vertical and Main Bus Parts

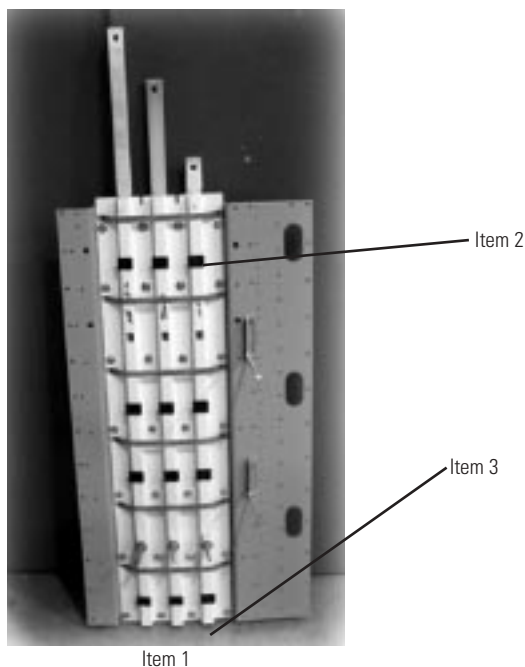

*Vertical Bus Assembly, 90-inch High Section, 4-inch Main Bus Bars*

Item	Height of Bottom Horizontal Wireway Cover	Short-circuit Bracing	Vertical Bus Rating (Amps)	Cat. No.
1	12-inch	22000 AIC	300	IC110V3*66#1
	6-inch	22000 AIC	300	IC110V3*72#1
	12-inch	22000 AIC	450	IC110V4*66#1
	6-inch	22000 AIC	450	IC110V4*72#1
	12-inch	22000 AIC	600	IC110V6*66#1
	6-inch	22000 AIC	600	IC110V6*72#1
	12-inch	42000 AIC	300	IC110V3*66#3
	6-inch	42000 AIC	300	IC110V3*72#3
	12-inch	42000 AIC	450	IC110V4*66#3
	6-inch	42000 AIC	450	IC110V4*72#3
	12-inch	42000 AIC	600	IC110V6*66#3
	6-inch	42000 AIC	600	IC110V6*72#3
	12-inch	65000 AIC	300	IC110V3*66#5
	6-inch	65000 AIC	300	IC110V3*72#5
	12-inch	65000 AIC	450	IC110V4*66#5
	6-inch	65000 AIC	450	IC110V4*72#5
	12-inch	65000 AIC	600	IC110V6*66#5
	6-inch	65000 AIC	600	IC110V6*72#5

\* For 20-inch wide section, insert "M". For 24-inch wide section, insert "A".

# For Copper with Tin Immersion Plating, insert "B". For Copper with Silver Immersion Plating, insert "C".





## 8000-Line/Spectra Motor Control Center

### Vertical and Main Bus Parts

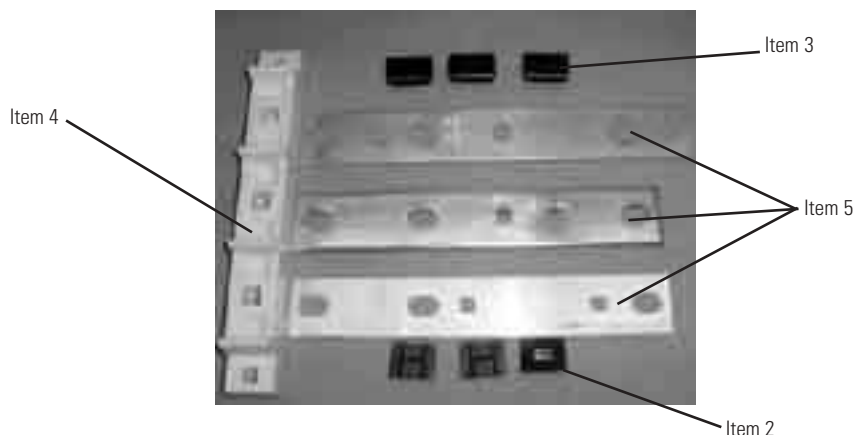

*Vertical Bus Assembly, 90-inch High Section, 2-inch Main Bus Bars*

Item	Height of Bottom Horizontal Wireway Cover	Short-circuit Bracing	Vertical Bus Rating (Amps)	Cat. No.
1	6-inch	42000 AIC	300	IC110V3*66#3
	12-inch	42000 AIC	300	IC110V3*60#3
	6-inch	42000 AIC	450	IC110V4*66#3
	12-inch	42000 AIC	450	IC110V4*60#3
	6-inch	42000 AIC	600	IC110V6*66#3
	12-inch	42000 AIC	600	IC110V6*60#3
	6-inch	65000 AIC	300	IC110V3*66#5
	12-inch	65000 AIC	300	IC110V3*60#5
	6-inch	65000 AIC	450	IC110V4*66#5
	12-inch	65000 AIC	450	IC110V4*60#5
	6-inch	65000 AIC	600	IC110V6*66#5
	12-inch	65000 AIC	600	IC110V6*60#5

\* For 20-inch wide section, insert "N". For 24-inch wide section, insert "B".

# For Copper with Tin Plating, insert "B". For Copper with Silver Plating, insert "C".

Item	Description	Cat. No.
2	Plug for Stab Opening	204B4050VPP1
3	Vertical Bus Isolator (bottom)	151A7284P1
4	Main Bus Support (2-inch bus bars)	117B5047P1
	Main Bus Support (4-inch bus bars)	68J122091FQ0000AAB
5	Insulator (Not Shown)	75A105521P101

*Vertical Bus Assembly for Back-to-Back Construction*

Short-circuit Bracing	Front Vertical Bus Assembly	Rear Vertical Bus Assembly*
22000 AIC	Use Standard Catalog Number	Use Standard Catalog Number
42000 AIC	Change Last Digit of Standard Cat. No. from 3 to 4	Use Standard Catalog Number

*Caution: If the original 8000-Line MCC was not ordered with back-to-back construction and was braced for 42000 AIC, the rear vertical bus assembly will not physically fit in back-to-back construction.*





## 8000-Line/Spectra Motor Control Center

### Vertical and Main Bus Parts

#### Main Bus Assemblies – Main Bus Bar 2-inch

Item	Rating (Amps)	Material	Plating	Phase/Location	Cat. No.	
					22000/42000 Bracing	65000 AIC Bracing
6	600	Copper	Tin	L1-Top	193A7608P12*	148B5181P25*
				L2-Middle	193A7609P12*	148B5181P27*
				L3-Bottom	193A7610P12*	148B5181P29*
		Silver	L1-Top	193A7608P11*	148B5181P1*	
			L2-Middle	193A7609P11*	148B5181P5*	
			L3-Bottom	193A7610P11*	148B5181P9*	
	Alum.	Tin	L-Top	193A7608P3*	148B5181P4*	
			1-2-Middle	193A7609P3*	148B5181P8*	
			1-3-Bottom	193A7610P3*	148B5181P12*	
	800	Copper	Tin	L1-Top	193A7608P17*	148B5181P26*
				1-2-Middle	193A7609P17*	148B5181P28*
				W-Bottom	193A7610P17*	148B5181P30*
		Silver	L1-Top	193A7608P14*	148B5181P14*	
			L2-Middle	193A7609P14*	148B5181P18*	
			L3-Bottom	193A7610P14*	148B5181P22*	
		Alum.	Tin	L1-Top	193A7608P6*(#)	148B5181P13*(#)
				L2-Middle	193A7609P6*(#)	148B5181P17*(#)
				L3-Bottom	193A7610P6*(#)	148B5181P21*(#)
1000	Copper	Tin	–	Same as 600 Amp only use 2 bars/phase		
		Silver	–	Same as 600 Amp only use 2 bars/phase		

\*Add one letter for each vertical section in the MCC line-up, to a maximum of 3; For 20-inch wide section, add "A". For 24-inch wide section, add "E".  
 # Use quantity of two (2) bars per phase.

#### Main Bus Assemblies – Main Bus Bar 4-inch

Item	Rating (Amps)	Material	Plating	Phase	Cat. No.	
					Front Bar	Rear Bar
6	1200	Copper	Tin	L1, L2 or L3	232A9481P12*	N/A
			Silver	L1, L2 or L3	232A9481P11*	N/A
		Alum.	Tin	L1, L2 or L3	232A9480P5*	232A9481P5*
	1600	Copper	Tin	L1, L2 or L3	232A9480P15*	232A9481P15*
			Silver	L1, L2 or L3	232A9480P16*	232A9481P16*
	2000	Copper	Tin	L1, L2 or L3	232A9480P19*	232A9481P19*
Silver			L1, L2 or L3	232A9480P20*	232A9481P20*	

\*Add one letter for each vertical section in the MCC line-up, to a maximum of 3; For 20-inch wide section, add "A". For 24-inch wide section, add "E".  
 # Use quantity of two (2) bars per phase.





## 8000-Line/Spectra Motor Control Center

### Vertical and Main Bus Parts

#### Other Common Parts (Not Shown)

Description			Cat. No.	
			Bus Bar	Splice Bar
Copper Ground Bus	1/4" x 1"	Unplated	193A7611P5*	232A9491P1
		Tin plated	193A7611P14*	232A9491P4
		Silver plated	193A7611P13*	232A9491P5
	1/4" x 2"	Unplated	193A7611P1*	151A1286P1
		Tin plated	193A7611P18*	151A1286P5
		Silver plated	193A7611P17*	151A1286P4
Aluminum Ground Bus	1/4" x 2"	Tin plated	193A7611P6*	193A7295P2
	3/8" x 2"	Tin plated	193A7611P20*	193A7295P1
Copper Neutral Bus	1/4" x 1"	Tin plated	193A7611P17*	161A9259P17
		Silver plated	193A7612P15*	161A9259P15
	1/4" x 2"	Tin plated	193A7612P13*	161A9259P10
		Silver plated	193A7612P12*	161A9259P9
	3/8" x 2"	Tin plated	193A7612P20*	161A9259P6
		Silver plated	193A7612P21*	161A9259P5
Aluminum Neutral Bus	1/4" x 2"	Tin plated	193A7612P16*	161A9259P13
	3/8" x 2"	Tin plated	193A7612P3*	148B5298P7

\* Add one letter for each vertical section in the MCC line-up, to a maximum of 3;

For 20-inch wide section, add "A"; For 24-inch wide section, add "E".

Description	Cat. No.
Alum. Joint Compound (Grease) 4 oz. tube	302A3747P3
Neutral Bus Mounting Bracket (minimum of 2-required)	151A1271P1
Neutral Bus Insulator (minimum of 2-required)	796A526P1
Vertical Bus Shutter Assembly	169C6350AY01

#### Main Bus Splice Bar Kits (Not Shown)

Main (Horizontal) Bus Data			Bus Splice Kit
Rating (Amps)	Material	Plating	Cat. No. ①
600	Copper	Tin	272A5610G26
	Copper	Silver	272A5610G1
	Aluminum	Tin	272A5610G9 ②
800	Copper	Tin	272A5610G25
	Copper	Silver	272A5610G27
	Aluminum	Tin	272A5610G6 ②
1000	Copper	Tin	272A5610G24
	Copper	Silver	272A5610G2
1200	Copper	Tin	272A5610G23
	Copper	Silver	272A5610G13
	Aluminum	Tin	272A5610G15 ②
1600	Copper	Tin	272A5610G22
	Copper	Silver	272A5610G11
2000	Copper	Tin	272A5610G21
	Copper	Silver	272A5610G12

① Kit Catalog Number includes bus splices required for one complete splice of all three phases of the main (i.e., horizontal bus).

② Aluminum joint compound (grease) must be ordered separately. Order Catalog Number; 302A3747P3.





# 8000-Line/Spectra Motor Control Center Unit Parts

8000-Line

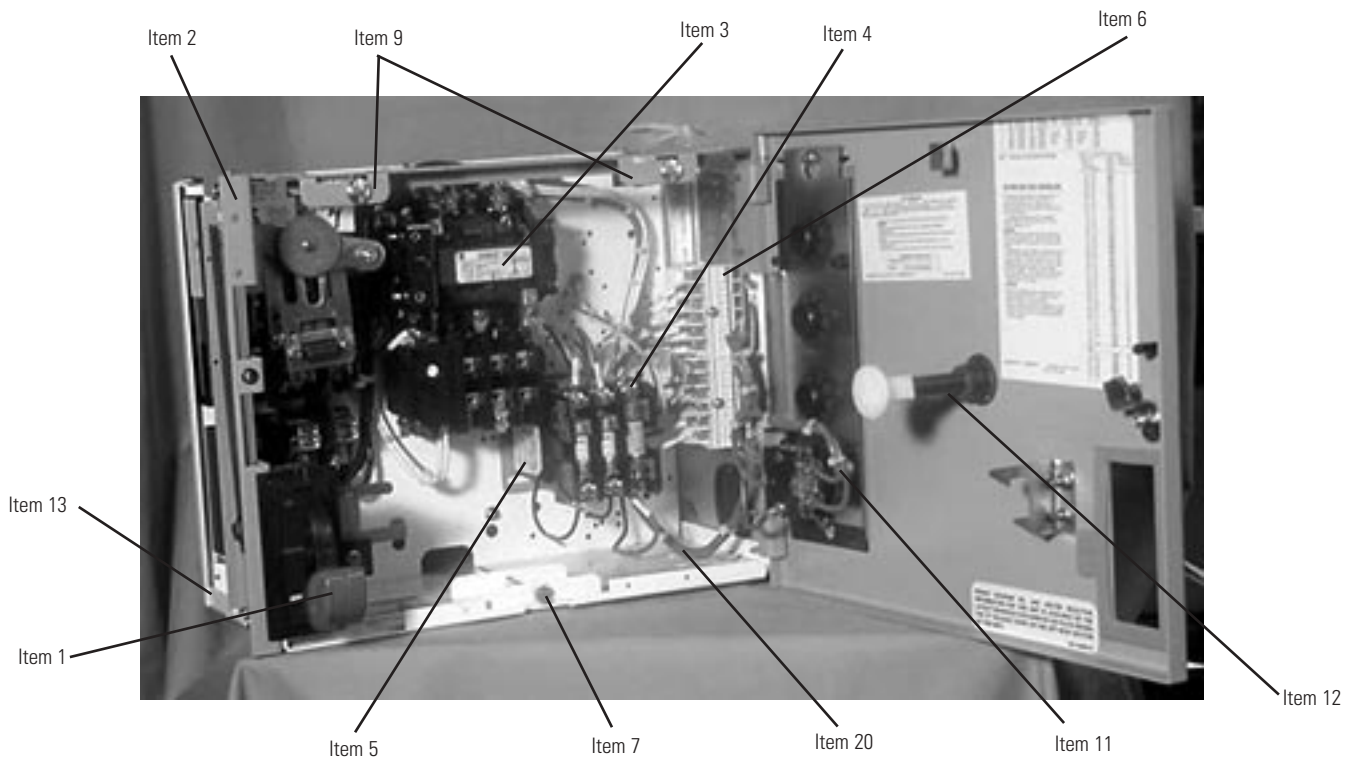



# 800-Line/Spectra Motor Control Center Unit Parts

## 800-Line & Spectra

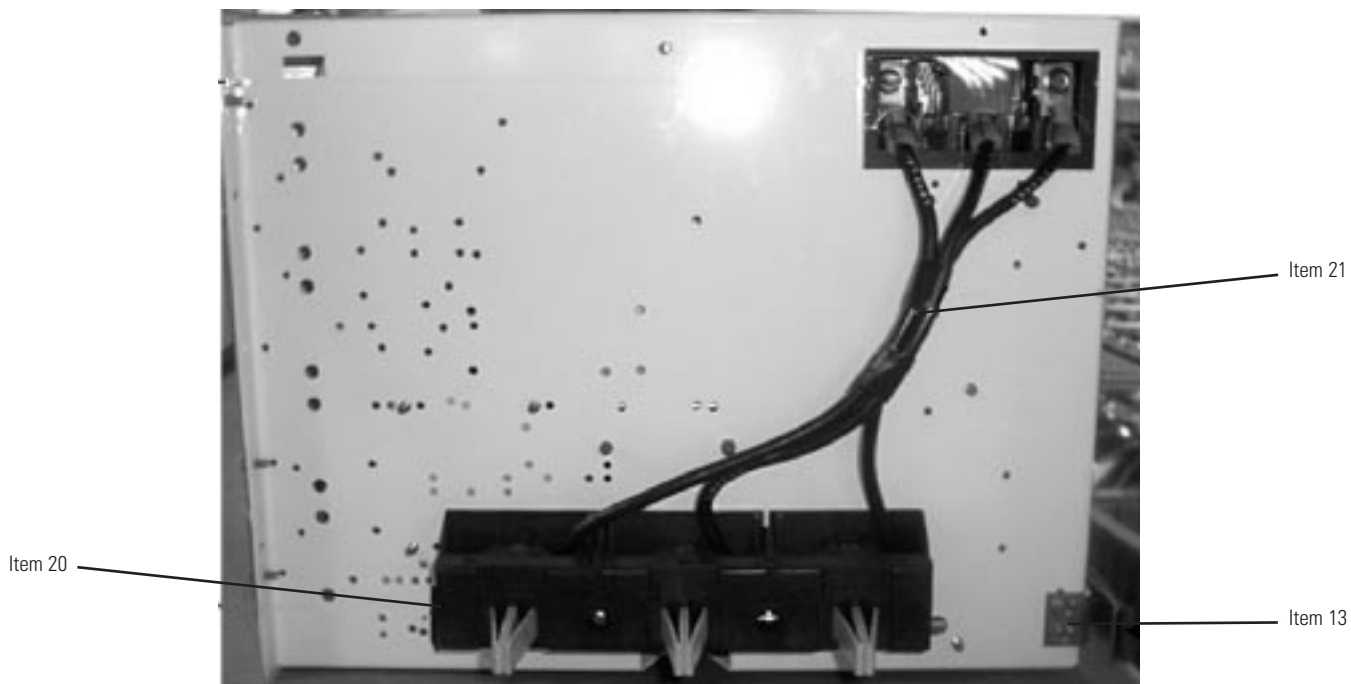

## Spectra

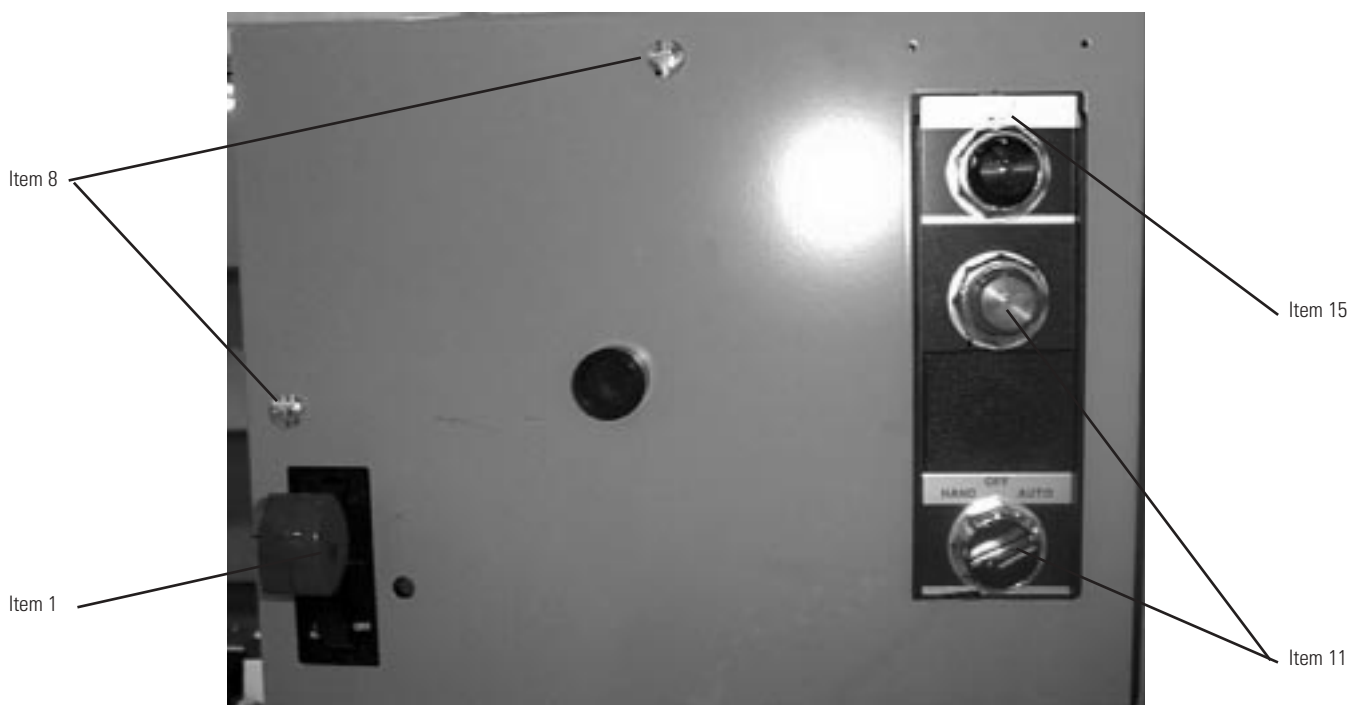





# 8000-Line/Spectra Motor Control Center Unit Parts

*Spectra*

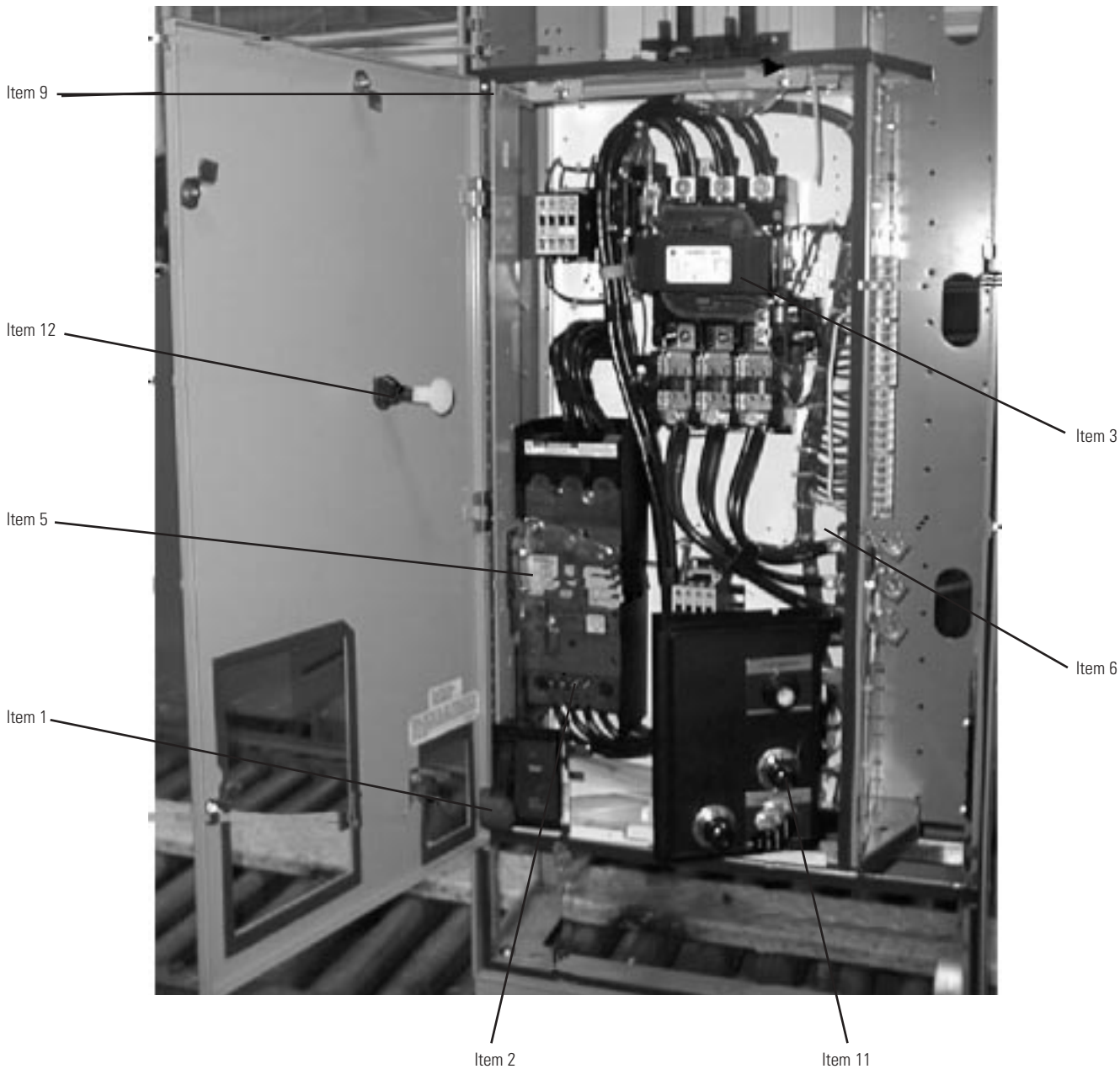





## 8000-Line/Spectra Motor Control Center

### Unit Parts

#### Handle/Handle Assembly

8000 Line – Handles for combination starter units, “Handle (Only)” includes plastic handle with egg-shaped knob; “Handle assembly” includes handle, egg-shaped knob, escutcheon, and steel linkage to mount on unit.

Item	Unit Function	NEMA Size	Unit Door Height (Inches)	Handle Only Cat. No. 204B4050	Circuit Breaker Combination		Fusible Disconnect Combination		
					Type	Handle Assembly Cat. No.	Max. Fuse Size (Amps)	Handle Assembly Cat. No.	
1	FVNR	1 or 2	12	RWG6	TED-TEC-TECL	169C6350KEG1	30/60	169C6350KHG1	
			18	RWG6	TED-TEC-TECL	169C6350KEG2	30/60	169C6350KHG2	
			24	RWG6	TED-TEC-TECL	169C6350KEG3	30/60	169C6350KHG3	
			18	RWG6	TB1	169C6350KJG1			
			24	RWG6	TB1	169C6350KJG2			
		30	RWG6	TB1	169C6350KJG3				
		2	18	RWG6				100	169C6350KHG14
			24	RWG6				100	169C6350KHG3
			30	RWG6				100	169C6350KHG4
		3	24	RWG6	TED-TEC-TECL-TB1	169C6381ABG2	100	169C6350KHG6	
			24	RWG5	TFJ-TFK	169C6381AAG1	–	–	
			30	RWG6			200	169C6350KHG7	
			36	RWG6			200	169C6350KHG8	
		4	42	RWG6			200	169C6350KHG9	
			30	RWG6	TED-TEC-TECL-TB1	169C6381ABG2			
	30		RWG5	TFJ-TFK	169C6381AAG1				
	42		RWG6			400	169C6350KGG3		
	5	48	RWG6			400	169C6350KGG3		
		36	FNG2	TJK-TJC	169C6381AKG1				
		42	FNG2	TB4	169C6381AKG1				
		48	FNG2	TKM-TKC-TB6	169C6381AKG1				
			54	FNG2	Spectra G-Frame		600	169C6381AKG2	
	FVR	1	18	RWG6	TED-TEC-TECL	169C6350KEG2	30/60	169C6350KHG2	
			24	RWG6	TED-TEC-TECL	169C6350KEG3	30/60	169C6350KHG3	
			30	RWG6	TED-TEC-TECL	169C6350KEG4	30/60	169C6350KHG4	
		2	36	RWG6	TED-TEG-TECL	169C6350KEG5	30/60	169C6350KHG1	
			24	RWG6			100	169C6350KHG5	
			30	RWG6			100	169C6350KHG12	
		3	36	RWG6			100	169C6350KHG13	
			42	RWG6			200	169C6350KHG9	
3 or 4		48	RWG6			200	169C6350KHG10		
		36	RWG6	TED-TEC-TECL-TB1	169C6381ABG2				
4		36	RWG5	TFJ-TFK	169C6381AAG1				
		42	FNG2	TB4	169C6381AKG5				
5		60	RWG6			400	169C6350KGG1		
		66	FNG2	Spectra G-Frame TJJ-TJK-TJC	169C6381AKG5	600	169C6381AKG2		





## 8000-Line/Spectra Motor Control Center Unit Parts

### Handle/Handle Assembly

8000 Line – Handles for combination starter units, “Handle (Only)” includes plastic handle with egg-shaped knob; “Handle assembly” includes handle, egg-shaped knob, escutcheon, and steel linkage to mount on unit.

Item	Unit Function	NEMA Size	Unit Door Height (Inches)	Handle Only Cat. No. 204B4050	Circuit Breaker Combination		Fusible Disconnect Combination		
					Type	Handle Assembly Cat. No.	Max. Fuse Size (Amps)	Handle Assembly Cat. No.	
1	FVR	2	48	RWG6	TED-TEC-TECL	169C6350KEG1	100	169C6350KHG1	
		3 or 4	48-54	RWG6	TED-TEC-TECL-TB1	169C6381ABG3			
			60	RWG6	TED-TEC-TECL-TS1	169C6350KEG1	–		
			48-54-60	RWG6	TFJ	169C6381AAG1	200	169C6350KHG1	
			48-54-60	RWG5	TFK	169C6381AAG1	400	169C6350KGG1	
			5	54	FNG2	TJJ-TJK-TJC	169C6381AKG5		
		66		FNG2	TKM-TKC	169C6381AKG5	600	169C6381AKG2	
		Part Winding	1	24	RWG6	TED-TEC-TECL	169C6350KEG3	100	169C6350KHG3
			2	30	RWG6	TED-TEC-TECL	169C6350KEG4	100	169C6350KHG4
				30	RWG5	TFJ-TFK	169C6381AAG1		
	36			RWG6			200	169C6350KHGB	
	3		48 (Vert.)	RWG6	TED-TEC-TECL	169C6350KEG1			
			48 (Horiz.)	RWG6	TED-TEC-TECL	169C6381ABG3			
			48 or 54	RWG6			200	169C6350KHG1	
	3 or 4		48	RWG5	TFJ-TFK	169C6381AAG1			
			60	RWG6			400	169C6350KGG1	
	4		667	FNG2	TJJ-TJK	169C6381AKG5	600	169C6381AKG2	
	2S1W	1	18	RWG6	TED-TEC-TECL	169C6350KEG2	30/60	169C6350KHG2	
	2S2W	1 or 2	24	RWG6	TED-TEC-TECL	169C6350KEG3	30/60	169C6350KHG3	
			30	RWG6	TED-TEC-TECL	169C6350KEG4	30/60	169C6350KHG4	
		2	36	RWG6	TED-TEC-TECL	169C6350KEG5	30/60	169C6350KHG11	
			24	RWG6			100	169C6350KHG5	
			30	RWG6			100	169C6350KHG12	
			36	RWG6			100	169C6350KHG13	
			3	48	RWG6			200	169C6350KHG10
		3 or 4	42	RWG6	TED-TEC-TECL-TB1	169C6381ASG2			
			42	RWG5	TFJ-TFK	169C6381AAG1			
		4	60	RWG6			400	169C6350KGG1	
		5	66		TJJ-TJK-TJC, Spectra G-Frame	169C6381AKG1	600	169C6381AKG2	





## 8000-Line/Spectra Motor Control Center Unit Parts

### Handle/Handle Assembly

*Spectra Line* – Handles for combination starter units, “Handle (Only)” includes plastic handle with egg-shaped knob; “Handle assembly” includes handle, egg-shaped knob, escutcheon, and steel linkage to mount on unit.

Item	Application	Space Height	Where Used	Mounted	Cat. No.
1	Size 1 & 2 FVNR	1.0	SELI, SELT	Vertical	137D7060AYG1
	Size 1 - 3 FVNR, FVR, 2S1W, 2S2W	1.5	SELI, SELT	Vertical	137D7060AYG2
	Size 1 - 3 FVNR, FVR, 2S1W, 2S2W	2.0	SELI, SELT	Vertical	137D7060AYG3
	Size 1 - 3 FVNR, FVR, 2S1W, 2S2W	2.5	SELI, SELT	Vertical	137D7060AYG4
	Size 1 - 3 FVNR, FVR, 2S1W, 2S2W	3.0	SELI, SELT	Vertical	137D7060AYG5
	Feeder	1.5	SELI, SELT	Vertical	137D7060AYG8
	Feeder	1.5	SELI, SELT	Vertical	137D7060AYG20
	Size 3 FVR, 2S1W, 2S2W	3.5	SELI, SELT	Vertical	137D7060AYG6
	Size 3 FVR, 2S1W, 2S2W	4.0	SELI, SELT	Vertical	137D7060AYG7
	Size 4 FVNR	2.5	SFLT, SFLI	Vertical	137D7060AYG16
	Size 4 FVNR	3.0	SFLT, SFLI	Vertical	137D7060AYG17
	Size 4 FVNR	3.5	SFLT, SFLI	Vertical	137D7060AYG18
	Size 4 FVNR, FVR, 2S1W, 2S2W	4.0	SFLT, SFLI	Vertical	137D7060AYG19
	Feeder	1.5	SFLT, SFLI	Vertical	137D7060AYG26
	Size 1 & 2 FVNR, Feeder	1.0	THED, TEC, TEDL	Vertical	137D7060AYG9
	Size 1 & 2 FVNR, FVR, 2S1W, 2S2W, Feeder	1.5	THED, TEC, TEDL	Vertical	137D7060AYG10
	Size 1 & 2 FVNR, FVR, 2S1W, 2S2W, Feeder	2.0	THED, TEC, TEDL	Vertical	137D7060AYG11
	Size 1 & 2 FVNR, FVR, 2S1W, 2S2W, Feeder	2.5	THED, TEC, TEDL	Vertical	137D7060AYG12
	Size 1 - 4 AF3, SSS	3.0	SELI, SELT	Vertical	137D7060AYG13
Size 1 - 4 AF3, SSS	3.5	SELI, SELT	Vertical	137D7060AYG14	
Size 1 - 4 AF3, SSS	4.0	SELI, SELT	Vertical	137D7060AYG15	

Item	Application Type	Space Height	Circuit Breaker	Mounted	Cat. No.
1	Feeder	0.5	SELI, SELT	Horizontal	137D7060BDG1
	Size 3 & 4 FVNR	2.5	THED, TEDL	Horizontal	137D7060BDG12
	Feeder	1.0	TB1	Horizontal	137D7060BDG3
	Feeder	0.5	FUSIBLE SWITCH	Horizontal	137D7060BDG4
	Feeder	1.0	FUSIBLE SWITCH	Horizontal	137D7060BDG5
	Feeder in Stab-bolt Combo	0.5	SELI, SELT	Horizontal	137D7060BDG6
	Size 4 FVNR	3.0	THED, TEDL	Horizontal	137D7060BDG7
	Feeder	1.0	THED, TEDL	Horizontal	137D7060BDG8
	Feeder	1.5	TB1	Horizontal	137D7060BDG9
	Feeder in Stab-bolt Combo	1.0	SELI, SELT	Horizontal	137D7060BDG11





## 8000-Line/Spectra Motor Control Center Unit Parts

### Handle/Handle Assembly

*Spectra Line* – Handles for combination starter units, “Handle (Only)” includes plastic handle with egg-shaped knob; “Handle assembly” includes handle, egg-shaped knob, escutcheon, and steel linkage to mount on unit.

Item	Application Type	Space Height	Circuit Breaker	Cat. No.
1	Size 1 & 2 FVNR	1.0	Fused Switch 100A	137D7060AZG1
	Size 1 & 2 FVNR, FVR, 2S1W, 2S2W	1.5	Fused Switch 100A	137D7060AZG2
	Size 1 & 2 FVNR, FVR, 2S1W, 2S2W	2.0	Fused Switch 100A	137D7060AZG3
	Size 1 & 2 FVNR, FVR, 2S1W, 2S2W	2.5	Fused Switch 100A	137D7060AZG4
	Size 1 & 2 FVNR, FVR, 2S1W, 2S2W	3.0	Fused Switch 100A	137D7060AZG5
	Size 1 & 2 FVNR, FVR, 2S1W, 2S2W	3.5	Fused Switch 100A	137D7060AZG6
	Size 1 & 2 FVNR, FVR, 2S1W, 2S2W	4.0	Fused Switch 100A	137D7060AZG7
	Size 3 FVNR	2.5	Fused Switch 100A	137D7060AZG11
	Size 3 FVNR	2.5	Fused Switch 100A	137D7060AZG12
	Size 3 FVNR	3.0	Fused Switch 100A	137D7060AZG13
	Size 3 FVNR	3.0	Fused Switch 100A	137D7060AZG14
	Size 3 2S1W, 2S2W	3.5	Fused Switch 100A	137D7060AZG15
	Size 3 2S1W, 2S2W	4.0	Fused Switch 100A	137D7060AZG16

Item	Application	Space Height	Circuit Breaker	Mounted	Cat. No.
1	Feeder	2.0	Fused Switch 200A	Horizontal	137D7060BFG1
	Feeder	2.5	Fused Switch 200A	Horizontal	137D7060BFG2
	Size 4 FVNR	3.0	Fused Switch 200A	Horizontal	137D7060BFG3
	Size 4 FVNR	3.5	Fused Switch 200A	Horizontal	137D7060BFG4
	Size 4 FVNR	4.0	Fused Switch 200A	Horizontal	137D7060BFG5
	Feeder in Stab-Bolt Combo	3.0	Fused Switch 200A	Horizontal	137D7060BFG6

Description	Cat. No.
<i>Spectra Pushbutton Bracket</i>	169C6383DNP3
<i>Hole Plug</i>	272A5650UWG2
<i>Spectra Resets</i>	
all size 1 functions	204B4142BDG1
size 2 FVNR & PW	204B4142BDG2
size 2 FVR , 2S1W, 2S2W	204B4142BDG3
size 3 & 4 FVNR, FVR, 2S1W, 2S2W	204B4142BDG4
size 3 & 4 RVNR, PW, YD	204B4142BDG5
size 5 FVNR, RVNR, FVR, 2S1W, 2S2W	204B4142BDG6
size 6 FVNR, RVNR, FVR	204B4142BDG7
<i>Spectra Latches</i>	273A7734G1 thru G6
Full width feeder and main doors	273A7734G3
Drawout starter units	273A7734G6
Used on size 5 & 6 starters	273A7734G8





## 8000-Line/Spectra Motor Control Center Unit Parts

### Handle/Handle Assembly

*Handles for Feeder Tap Units (Not Shown)*

Item	Unit Door Height (Inches)	Handle Cat. No. 204B4050	Circuit Breaker		Fusible Disconnect	
			Type	Handle Assembly Cat. No.	Rating (Amps)	Handle Assembly Cat. No.
1A	6	RWG6	TED-THED	169C6381ABG1	30	169C6381ABG4
		RWG6	TB1	169C6381ABG1	60	169C6381ABG4
	12	RWG6	TED-THED	169C6350KEG1	30 OR 60	169C6381ABG1
		RWG6	TB1	169C6381ABG3	100	169C6381ABG1
		RWG5	TFJ-TFK	169C6381AAG1	–	
	24	FNG2	TJJ-TJK	169C6381AKG1	–	
		RWG6	–	–	200	169C6381ABG1
	30	FNG2	TB4	169C6381AKG1	–	
42	FNG2	TKM	169C6381AKG1	–		
48	FNG2	TB6	169C6381AKG1	200 OR 400	169C6381ABG1	

*For 150 ampere TED-THED circuit breaker in 12-inch space, use Catalog Number 169C6381ABG3.*

*Handles for Main Disconnects (Not Shown)*

Item	Unit Door Height (Inches)	Handle Cat. No. 204B4050	Circuit Breaker		Fusible Disconnect	
			Type	Handle Assembly Cat. No.	Rating (Amps)	Handle Assembly Cat. No.
1B	18	WG5	TFJ-TFK	169C6381AAG1	–	–
	24	FNG2	TJJ-TJK	169C6381AKG1	–	–
	30	FNG2	TB4-TB6	169C6381AKG1	–	–
	30	RWG6	–	–	200	169C6350KGG2
	36	FNG2	TB6	169C6381AKG1	400 or 600	169C6381AKG2
	Any	FNG2	TKM	169C6381AKG1	–	–
			Spectra G-Frame	169C6381AKG1	–	–





## 8000-Line/Spectra Motor Control Center Unit Parts

### Branch Overcurrent Protective Device

**Circuit Breaker:** 8000-line motor control centers utilize General Electric circuit breakers in combination starters, feeder tap units and main disconnect units. Replacement circuit breakers may be purchased through your local General Electric Distributor.

**Fusible Disconnect:** Modified versions of QMR and QMW switches are utilized in 8000-Line construction. When selecting the proper replacement switch, consideration must be given to the following:

- 1- Type of switch (QMR or QMW)
- 2- Size of starter, feeder or main
- 3- Fuse amperage and type of clip
- 4- Power supply voltage

Complete fusible disconnect switches consist of switch assembly, fuse clip base or base (as required), plus other factory modifications. Order by complete catalog number as listed in the tables on the following pages.

### Fusible Disconnect Switches

*For Starter Units (All Functions Except Part-winding, See Notes on Page 21).*

Item	NEMA Size	Switch Rating (Amps)	Fuse Clips		QMR Switch Cat. No.	QMW Switch Cat. No.	Installation Kit
			Type	Rating (Amps)			
2	1	30	R	0-30	204B4053G10	204B4054G10	204B4050VEG1
			R	31-60	204B4053G11	204B4054G11	204B4050VEG1
			J	0-30	204B4053G6	204B4054G6	204B4050VEG1
			J	31-60	204B4053G7	204B4054G7	204B4050VEG1
	2	60	R	0-30	204B4053G26	204B4054G26	204B4050VEG1
			R	31-60	204B4053G27	204B4054G27	204B4050VEG1
			R	61-100	204B4053G76	204B4054G76	204B4050VEG1
			J	0-30	204B4053G19	204B4054G19	204B4050VEG1
			J	31-60	204B4053G20	204B4054G20	204B4050VEG1
			J	61-100	204B4053G74	204B4054G74	204B4050VEG1
			R	31-60	204B4053G62	204B4054G62	204B4050VEG2
			R	61-100	204B4053G63	204B4054G63	204B4050VEG2
	3 <sup>①</sup>	100	R	101-200	204B4053G64	204B4054G64	204B4050VEG2
			J	31-60	204B4053G54	204B4054G54	204B4050VEG2
			J	61-100	204B4053G55	204B4054G55	204B4050VEG2
			J	101-200	204B4053G56	204B4054G56	204B4050VEG2
			R	61-100	204B4055G14	204B4056G14	204B4050VKP1 plus 272AS650BTP1
			R	101-200	204B4055G15	204B4056G15	
	R	201-400	204B4055G26	204B4056G26			
	J	61-100	204B4055G8	204B4056G8			
	J	101-200	204B4055G9	204B4056G9			
	4	200	J	201-400	204B4055G24	204B4056G24	
			R	201-400	THM3565ICD	N/A	TPBRK56A
			R	401-600	THM3566ICD	N/A	TPBRK56A
J			201-400	THM35J5ICD	N/A		
J			401-600	THM35J6ICD	N/A		
J			401-600	THM35J6ICD	N/A		

① For 24-inch high unit, refer to Spare Recommendations before ordering.





## 8000-Line/Spectra Motor Control Center Unit Parts

For Feeder Units. See Notes Below.

Item	Switch Size (Amps)	Unit Door Height (In.)	Fuse Clips		QMR Switch Cat. No.	QMW Switch Cat. No.	Installation Kit
			Type	Rating (Amps)			
2	30	6	R	0-30	204B4053G10	204B4054G10	Kit Number 1
			J	0-30	204B4053G6	204B4054G6	Kit Number 1
		12	R	0-30	204B4053G10	204B4054G10	Kit Number 2
			J	0-30	204B4053G6	204B4054G6	Kit Number 2
	60	6	R	31-60	204B4053G27	204B4054G27	Kit Number 3
			J	31-60	204B4053G20	204B4054G20	Kit Number 3
		12	R	31-60	204B4053G27	204B4054G27	Kit Number 4
			J	31-60	204B4053G20	204B4054G20	Kit Number 4
	100	12	R	61-100	204B4053G78	204B4054G78	Kit Number 5
			J	61-100	204B4053G55	204B4054G55	Kit Number 5
	200	24	R	101-200	204B4055G21	204B4056G21	Kit Number 6
			J	101-200	204B4055G19	204B4056G19	Kit Number 6
	400	48	R	201-400	THM3565ICD	N/A	Kit Number 7
			J	201-400	THM35J5ICD	N/A	Kit Number 7
	600	48	R	401-600	THM3666ICD	N/A	Kit Number 8
			J	401-600	THM36J6ICD	N/A	Kit Number 8

### Fusible Disconnect Switches

For Part-winding Starter Units Only. See Notes Below.

Item	NEMA Size	Switch Rating (Amps)	Fuse Clips		QMR Switch Cat. No.	QMW Switch Cat. No.	Installation Kit
			Type	Rating (Amps)			
2	1	30	R	0-30	204B4053G10	204B4054G10	204B4050VEG1
			R	31-60	204B4053G11	204B4054G11	204B4050VEG1
			J	0-30	204B4053G6	204B4054G6	204B4050VEG1
			J	31-60	204B4053G7	204B4054G7	204B4050VEG1
	1 or 2	60	R	31-60	204B4053G27	204B4054G27	204B4050VEG1
			R	61-100	204B4053G76	204B4054G76	204B4050VEG1
			J	31-60	204B4053G20	204B4054G20	204B4050VEG1
			J	61-100	204B4053G74	204B4054G74	204B4050VEG1
	2 or 3	100	R	101-200	204B4053G52	204B4054G52	204B4050VEG2
			J	101-200	204B4053G56	204B4054G56	204B4050VEG2
	3	100	R	61-100	204B4053G78	204B4054G78	204B4050VEG2
			J	61-100	204B4053G55	204B4054G55	204B4050VEG2
	3 or 4	200	R	101-200	204B4055G21	204B4056G21	204B4050VKP1 plus 272A5650BTP1
			R	201-400	204B4055G26	204B4056G26	
			J	101-200	204B4055G19	204B4056G19	
			J	201-400	204B4055G24	204B4056G24	
	4	400	R	201-400	THM3565ICD	N/A	TPBRK56A
			R	401-600	THM3566ICD	N/A	TPBRK56A
			J	201-400	THM35J5ICD	N/A	
			J	401-600	THM35J6ICD	N/A	

For Main Switches. See Notes Below.

Item	Switch Size (Amps)	Unit Door Height (In.)	Fuse Clips		QMR Switch Cat. No.	QMW Switch Cat. No.	Installation Kit
			Type	Rating (Amps)			
2	200	30	R	101-200	204B4055G15	204B4056G15	Kit Number 9
			J	101-200	204B4055G19	204B4056G19	Kit Number 9
	400	36	R	201-400	THM3565ICD	N/A	Kit Number 7
			J	201-400	THM35J5ICD	N/A	Kit Number 7
	600	36	R	401-600	THM3666ICD	N/A	Kit Number 8
			J	401-600	THM36J6ICD	N/A	Kit Number 8

### Notes For Item 2 (Fusible Disconnect Switch)

- All switches listed are rated for 600 volts; for 250 volt applications, refer to Spare Recommendations.
- Installation kit must be ordered and installed with the replacement switch to obtain the complete switch assembly.
- Parts called for in individual Kit numbers must be ordered individually; do not order by kit number.





## 8000-Line/Spectra Motor Control Center Unit Parts

### Fusible Disconnect Switches

*Installation Kit-For QMR/QMW Feeder Units And Main Switches*

Cat. No.	Description	Kit Number Quantity Required								
		1	2	3	4	5	6	7	8	9
TPBRK56A	Rejection Pin Kit (R)							1	1	
113A5436P1	Lug			3	3					
113A5437P1	Lug					3				
204B4050FVP1	Switch Insulator		1							
204B4050VEG1	QMR/QMW Parts Assembly		1		1					
204B4050VEG2	QMR/QMW Parts Assembly					1				
204B4050VKP1	Line Shield						1			
204B4118ACP1	Bat-wing Insulators	1		1						
204B4118ACP2	Bat-wing Insulators	1		1						
232A6981P4	Lug									3
232A6981P12	Lug								3	
264V195P1	Lug	3	3							
272A5602ESP1	Load Base Insulator		1		1					
272A5650BMP3	Line Shield	1		1						
272A5650BTP1	Line Shield Nameplate	1		1						
272A5650KYP2	Insulator									1
272A5650L1KP1	Insulator		1		1					
68J122002AW0102AJB	Line Shield							1	1	
75B125076P1	Lug						3			
75B125077G701	Lug							3		

### Starter/Contactor

Item	
3	Refer to Spare Recommendations and Parts List for your motor control center. If none is available, refer to catalog number as it appears on the device itself before ordering replacement parts.

### Fuse Blocks (Control Circuit)

Item			
4	With Control Power Transformer 3-Pole	Primary and Secondary	CSC # 3032GE -EDC
	Without Control Power Transformer 2-Pole (J )	Standard	CSC # 60327SJ

### Control Power Transformer (120 Volt Secondary-60 Hz)

Item	Control Power Transformer	480 Volt Primary Cat. No.	600 Volt Primary Cat. No.
5	Size 1-FVNR/FVR (Standard) 60 VA	302A3600YDP201	Use 150 VA - Below
	Size 2-FVNR/FVR (Standard) 150 VA	302A3600YDP204	302A3600YDP226
	Size 3-FVNR/FVR (Standard) 300 VA	302A3600YDP207	302A3600YDP230
	Size 4-FVNR/FVR (Standard) 300VA	302A3600YDP207	302A3600YDP230







## 8000-Line/Spectra Motor Control Center Unit Parts

### Control Terminal Board

Item	3 Pt. Control Terminal Board	When Used	Cat. No.
6	Male	Mounted on starter unit	75B132504G701
	Female	Mounted on vertical section	204B4153APG1
	Mounting Clip	For female board	577A285P1
	Marking Strip	3 pt- blank	272A5615P101
	Assembly	All of the above	204B4048G1
	HDTB		CR151KPP56F
	HDTB RAIL		204B4153BCP1

Item	Description	Cat. No.
7	Racking Screw (Plug-In Units Only)	273A7722P1
	Retainer (Quantity 3)	204B4139AAG36
	Cupwasher (Quantity 3)	204B4139AAG37

Item	Description	Cat. No.
8	Door Latch Assembly (1/4-turn)	169C6366DMG2

Item	Description	Cat. No.
9	Unit Frame Latch Assembly (1/4-turn)	169C6386DMG1

### Slider Assembly (Inner-Outer)

Item	Slider Assembly	Cat.No.
10	Horizontally Mounted Disconnect: "E" Frame Circuit Breaker	204B4050VBG2
	"FJ-FK" Frame Circuit Breaker	204B4050VCG2
	Vertically Mounted Disconnect ("E" Frame Circuit Breaker; 30-200 Amp QMR/QMW)	204B4050VAG2

### Pilot Device Bracket Escutcheon

Item	Pilot Device	Cat.No.
11	Blank (No Holes)	169C6350KFP5
	4-hole	169C6350KFP4
	Plug-button Assembly (Black)	272A5650UWG2
	Plug-button Assembly (Gray)	272A5650UWG4
	Pilot Device Grounding Bracket	204B4050TTP1

### Overload Reset Assembly

Item	NEMA Size	Function	Cat.No.
12	1	All	204B4142BDG1
	2	FVNR	204B4142BDG2
	2	FVR-2SIW-2S2W	204B4142BDG3
	2	RVNR	204B4142BDG1
	3 or 4	FVNR-FVR-2SIW-2S2W	204B4142BDG4
	3 or 4	RVNR	204B4142BDG5
	5	FVNR-FVR-RVNR	204B4142BDG6
	Reset Extension Only	All	204B4050WBP1





## 8000-Line/Spectra Motor Control Center Unit Parts

### Vertical Ground Bus Stab Finger

Item	Description	Cat.No.
13	Vertical Ground Bus Stab Finger	259A3264G1

### Pilot Device (Type CR104P)

Item	Description
14	Pilot Device (Type CR104P) Refer to Spare Recommendations furnished with your motor control center.

### Unit Nameplate (Blank)

Item	Description	Cat. No.
15	White Face/Black Core	273A7916P3EC
	Black Face/White Core	273A7916P3FC
	Mounting Clip (2 required)	204B4139AAG5 (Qty 6)

### Power Terminal Board

Item	Style	Cat.No.	
16	NEMA Size 1 and 2	Male (Mounted on starter unit)	75B132504G701
		Female (Mounted on vertical section)	204B4153APG2
		Mounting Clip (For female board)	577A285P1
		Marking Strip (3 pt.-blank)	272A5615P101
		Assembly (All of above)	204B4048G4
	NEMA Size 3 and 4	Power TB	204B4050WDG1
Terminal Board Cover		204B4050NDP1	

### Harnesses

*Load Wire Harness (Starter to power terminal board)*

Item	Function	NEMA Size	Cat.No. (For Circuit Breaker)	Cat.No. (For Fusible Disconnect)
17	FVNR	1	8000T10G1	8000T10G2
		2	8000T6G2	8000T6G1
		3	8000T4G1	8000T4G1
		4	8000T4G1	8000T4G1
	FVR	1	8000T10G3	8000T10G3
		2	8000T6G3	8000T6G3
		3	8000T4G1	8000T4G1
		4	8000T4G1	8000T4G7
	2S1W or 2S2W	1	8000T10G4	8000T10G4
		2	8000T6G4	8000T6G4
		3	8000T4G1	8000T4G1
		4	8000T4G1	8000T4G9

**Note:** Above harnesses utilize standard GE type THW (flamenol) wire cable. Do not order above catalog numbers if your motor control center was ordered with special type power wire cable.

Item	Description	Cat.No.
18	Line Connection Barrier 30/60/100 ampere QMR/QMW Fusible Disconnect Switches (Only)	272A5650UJP1





## 8000-Line/Spectra Motor Control Center Unit Parts

Item	Description	Cat.No.
19	Stab Assembly (includes Plastic Base, Cover) - no stabs	117B6219G1

*Stab Power Harness (Includes harness and stab fingers)  
Combination Starter Units*

Item	NEMA Size	Function	Circuit Protective Device	Unit Door Height (inches)	Harness Cat.No.
20	1 or 2	FVR-2S1W-2S2W	QMR/QMW	18 or 24	8000L8G2
		FVNR	Circuit Breaker ("E")\	12 or 18	8000L8G1
		FVNR	Circuit Breaker ("7131")	18	8000L8G10
		FVNR	QMR/QMW (Max 60 Amp clips)	12 or 18	8000L8G2
		FVR-2S1W-2S2W	Circuit Breaker ("E")	18 or 24	8000L8G1
	2	FVNR	60 Amp QMR/QMW (100 Amp clips)	18	8000L8G8
		FVR	60 Amp QMR/QMW (100 Amp clips)	24	8000L8G9
	3	FVNR	Circuit Breaker ("E")	24	8000L4G1
		FVNR	Circuit Breaker ("E")	30	8000L4G4
		FVNR	QMR/QMW	24 or 30	8000L4G6
	3 or 4	FVNR-FVR	Circuit Breaker ("TFJ-TFK")	30 or 36	8000L4G2
		FVNR-FVR	QMR/QMW	42 or 60	8000L4G5

*Stab Power Harness (Includes harness and stab fingers)  
Feeder Units/Main Disconnects*

Item	Function	Rating (Amps)	Circuit Protective Device	Unit Door Height (inches)	Harness Cat.No.
20	Feeder (Horizontal)	0-50	Circuit Breaker (E-Frame TBI)	6	8000L8G7
		60-100	Circuit Breaker (E-Frame TBI)	6	8000L4G10
		110-150	Circuit Breaker (E-Frame TBI)	12	8000L4G4
		30	QMR/QMW	6	8000L8G7
		60	QMR/QMW	6	8000L6G1
		100	QMR/QMW	12	8000L4G7
	Feeder (Vertical)	0-50	Circuit Breaker (E-frame)	12	8000L8G1
		60-100	Circuit Breaker (E-frame)	12	8000L4G9
		30	QMR/QMW	12	8000L8G2
		60	QMR/QMW	12	8000L6G4
	Feeder	0-200	Circuit Breaker (TFJ-TFK)	12	8000L4G3
		200	QMR/QMW	24 or 30	8000L4G5
	Main	225	Circuit Breaker (TFJ-TFK)	18	8000L4G8
		200	QMR/QMW	30	8000L4G13

**Note:** Above harnesses utilize standard type THW wire or cable. Do not order above catalog numbers if your motor control center was ordered with special type power wire/cable.





## 8000-Line/Spectra Motor Control Center Unit Parts

**Torque Table**

Bolt Size	Copper Joints		Aluminum Joints	
	Lb-ft Min	Kg-m + Max	Lb-ft Min	Kg-m + Max
3/8 -16	12-16	1.66-2.21	11-14*	1.52-1.94
1/2- 13	30-39	4.15-5.39	24-27	3.32-3.73
2-inch (50.8) 1/2-13 Bus Splice Plate	24-27*	3.32-3.73	24-27*	3.32-3.73
4-inch (101.6 mm) 3/8-16 Bus Splice Plate	11-14*	1.52-1.94	11-14*	1.52-1.94
1/2-13	24-27*	3.32-3.73	24-27*	3.32-3.73
Special Incoming Line Main Lug "T" Bolt	25-30	3.46-4.15	–	–







*For further information call or write your local GE Industrial Systems Sales Office or  
General Electric Company  
PO Box 489  
Mebane, NC 27302  
919-563-7449*



**GE Industrial Systems**