

$V_{DM}$	=	2800 V
$I_{T(AV)M}$	=	2630 A
$I_{T(RMS)}$	=	4130 A
$I_{TSM}$	=	$43 \times 10^3$ A
$V_{T0}$	=	0.85 V
$r_T$	=	0.16 mW

# Bi-Directional Control Thyristor

## 5STB 24Q2800

Doc. No. 5SYA1053-02 May 07

- Two thyristors integrated into one wafer
- Patented free-floating silicon technology
- Designed for energy management and industrial applications
- Optimum power handling capability
- Interdigitated amplifying gate

The electrical and thermal data are valid for one-thyristor-half of the device (unless otherwise stated)

### Blocking

#### Maximum rated values<sup>1)</sup>

Parameter	Symbol	Conditions	5STB 24Q2800	Unit
Max repetitive peak forward blocking voltage	$V_{RM}$	$f = 50$ Hz, $t_p = 10$ ms, $T_{vj} = 5 \dots 125^\circ\text{C}$ , Note 1	2800	V
Critical rate of rise of off-state voltage	$dv/dt_{crit}$	Exp. to 1880 V, $T_{vj} = 125^\circ\text{C}$	1000	V/ $\mu\text{s}$

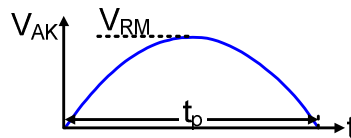

#### Characteristic values

Parameter	Symbol	Conditions	min	typ	max	Unit
Max reverse leakage current	$I_{RM}$	$V_{RM}$ , $T_{vj} = 125^\circ\text{C}$			400	mA

Note 1: Voltage de-rating factor of 0.11% per °C is applicable for  $T_{vj}$  below +5 °C

### Mechanical data

#### Maximum rated values<sup>1)</sup>

Parameter	Symbol	Conditions	min	typ	max	Unit
Mounting force	$F_M$		81	90	108	kN
Acceleration	$a$	Device unclamped			50	$\text{m/s}^2$
Acceleration	$a$	Device clamped			100	$\text{m/s}^2$

#### Characteristic values

Parameter	Symbol	Conditions	min	typ	max	Unit
Weight	$m$				2.1	kg
Housing thickness	$H$	$F_M = 90$ kN, $T_a = 25^\circ\text{C}$	25.8		26.4	mm
Surface creepage distance	$D_S$		36			mm
Air strike distance	$D_a$		15			mm

1) Maximum rated values indicate limits beyond which damage to the device may occur

ABB Switzerland Ltd, Semiconductors reserves the right to change specifications without notice.



## On-state

### Maximum rated values <sup>1)</sup>

Parameter	Symbol	Conditions	min	typ	max	Unit
Average on-state current	$I_{T(AV)M}$	Half sine wave, $T_c = 70\text{ °C}$			2630	A
RMS on-state current	$I_{T(RMS)}$				4130	A
RMS on-state current	$I_{T(RMS)}$	Full sine wave, $T_c = 70\text{ °C}$			5840	A
Peak non-repetitive surge current	$I_{TSM}$	$t_p = 10\text{ ms}$ , $T_{vj} = 125\text{ °C}$ , sine wave after surge: $V_D = V_R = 0\text{ V}$			$43.0 \times 10^3$	A
Limiting load integral	$I^2t$				$9.25 \times 10^6$	$A^2s$
Peak non-repetitive surge current	$I_{TSM}$	$t_p = 8.3\text{ ms}$ , $T_{vj} = 125\text{ °C}$ , sine wave after surge: $V_D = V_R = 0\text{ V}$			$46.0 \times 10^3$	A
Limiting load integral	$I^2t$				$8.78 \times 10^6$	$A^2s$

### Characteristic values

Parameter	Symbol	Conditions	min	typ	max	Unit
On-state voltage	$V_T$	$I_T = 3000\text{ A}$ , $T_{vj} = 125\text{ °C}$			1.35	V
Threshold voltage	$V_{T0}$	$I_T = 1500\text{ A} - 4500\text{ A}$ , $T_{vj} = 125\text{ °C}$			0.85	V
Slope resistance	$r_T$				0.16	$m\Omega$
Holding current	$I_H$	$T_{vj} = 25\text{ °C}$			250	mA
		$T_{vj} = 125\text{ °C}$			150	mA
Latching current	$I_L$	$T_{vj} = 25\text{ °C}$			500	mA
		$T_{vj} = 125\text{ °C}$			300	mA

## Switching

### Maximum rated values <sup>1)</sup>

Parameter	Symbol	Conditions	min	typ	max	Unit
Critical rate of rise of on-state current	$di/dt_{crit}$	$T_{vj} = 125\text{ °C}$ , $I_{TRM} = 3000\text{ A}$ , Cont. $f = 50\text{ Hz}$			250	$A/\mu s$
Critical rate of rise of on-state current	$di/dt_{crit}$	$V_D \leq 1880\text{ V}$ , $I_{FG} = 2\text{ A}$ , $t_r = 0.5\text{ }\mu s$ Cont. $f = 1\text{ Hz}$			500	$A/\mu s$
Circuit commutated turn-off time	$t_q$	$T_{vj} = 125\text{ °C}$ , $I_{TRM} = 2000\text{ A}$ , $V_R = 200\text{ V}$ , $di_T/dt = -1.5\text{ A}/\mu s$ , $V_D \leq 0.67 \cdot V_{RM}$ , $dv_D/dt = 20\text{ V}/\mu s$ ,	400			$\mu s$
Critical rate of rise of commutating voltage	$dv/dt_{com}$	$T_{vj} = 125\text{ °C}$ , $V_R \leq 0.67 \cdot V_{RM}$			500	$V/\mu s$

### Characteristic values

Parameter	Symbol	Conditions	min	typ	max	Unit
Reverse recovery charge	$Q_{rr}$	$T_{vj} = 125\text{ °C}$ , $I_{TRM} = 2000\text{ A}$ , $V_R = 200\text{ V}$ , $di_T/dt = -1.5\text{ A}/\mu s$	1000		2100	$\mu As$
Reverse recovery current	$I_{RM}$		30		80	A
Gate turn-on delay time	$t_{gd}$	$T_{vj} = 25\text{ °C}$ , $V_D = 0.4 \cdot V_{RM}$ , $I_{FG} = 2\text{ A}$ , $t_r = 0.5\text{ }\mu s$			3	$\mu s$

## Triggering

Maximum rated values <sup>1)</sup>

Parameter	Symbol	Conditions	min	typ	max	Unit
Peak forward gate voltage	$V_{FGM}$				12	V
Max. rated peak forward gate current	$I_{FGM}$				10	A
Peak reverse gate voltage	$V_{RGM}$				10	V
Max. rated gate power loss	$P_G$	For DC gate current			3	W
Max. rated peak forward gate power	$P_{GM(AV)}$		see Fig. 9			W

Characteristic values

Parameter	Symbol	Conditions	min	typ	max	Unit
Gate trigger voltage	$V_{GT}$	$T_{vj} = 25\text{ °C}$			2.6	V
Gate trigger current	$I_{GT}$	$T_{vj} = 25\text{ °C}$			400	mA
Gate non-trigger voltage	$V_{GD}$	$V_D = 0.4 \times V_{RM}$ , $T_{vj} = 125\text{ °C}$	0.3			V
Gate non-trigger current	$I_{GD}$	$V_D = 0.4 \times V_{RM}$	10			mA

## Thermal

Maximum rated values <sup>1)</sup>

Parameter	Symbol	Conditions	min	typ	max	Unit
Operating junction temperature range	$T_{vj}$				125	°C
Storage temperature range	$T_{stg}$		-40		140	°C

Characteristic values

Parameter	Symbol	Conditions	min	typ	max	Unit
Thermal resistance junction to case (Valid for one thyristor half no heat flow to the second half.)	$R_{th(j-c)}$	Double-side cooled $F_m = 81...108\text{ kN}$			10	K/kW
	$R_{th(j-c)}$	Single-side cooled $F_m = 81...108\text{ kN}$			20	K/kW
Thermal resistance case to heatsink	$R_{th(c-h)}$	Double-side cooled $F_m = 81...108\text{ kN}$			2	K/kW
	$R_{th(c-h)}$	Single-side cooled $F_m = 81...108\text{ kN}$			4	K/kW

Analytical function for transient thermal impedance:

$$Z_{th(j-c)}(t) = \sum_{i=1}^n R_i (1 - e^{-t/\tau_i})$$

i	1	2	3	4
$R_i$ (K/kW)	6.500	1.470	1.310	0.710
$\tau_i$ (s)	0.5205	0.1075	0.0194	0.0073

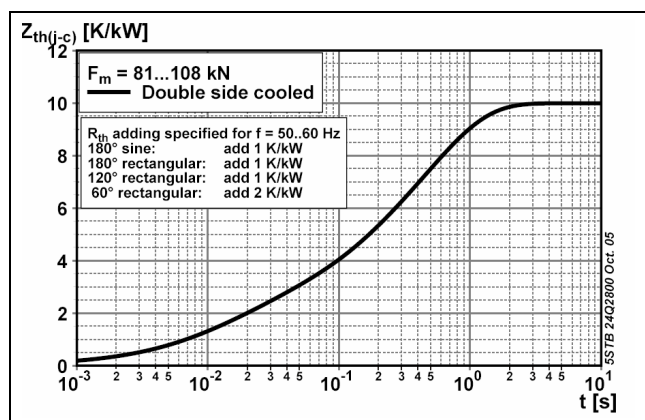

Fig. 1 Transient thermal impedance (junction-to-case) vs. time

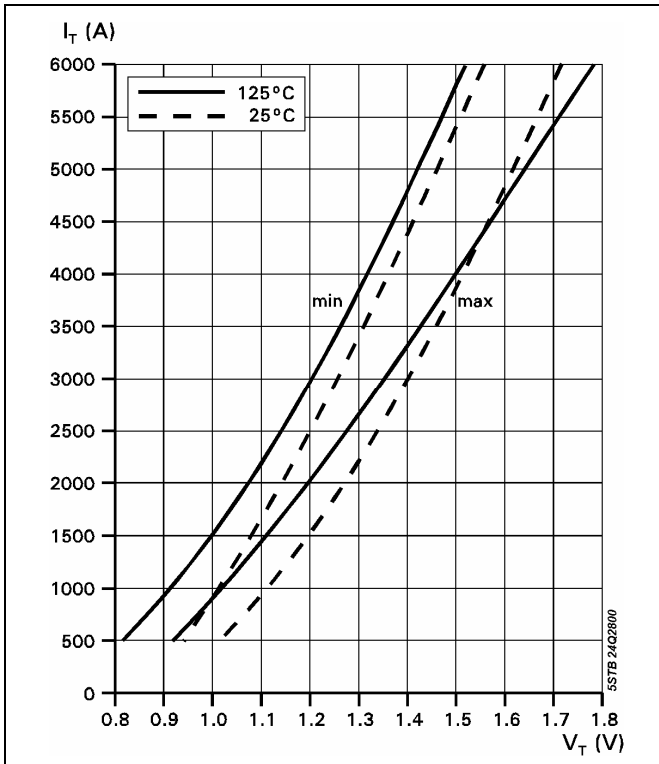

Fig. 2 On-state voltage characteristics

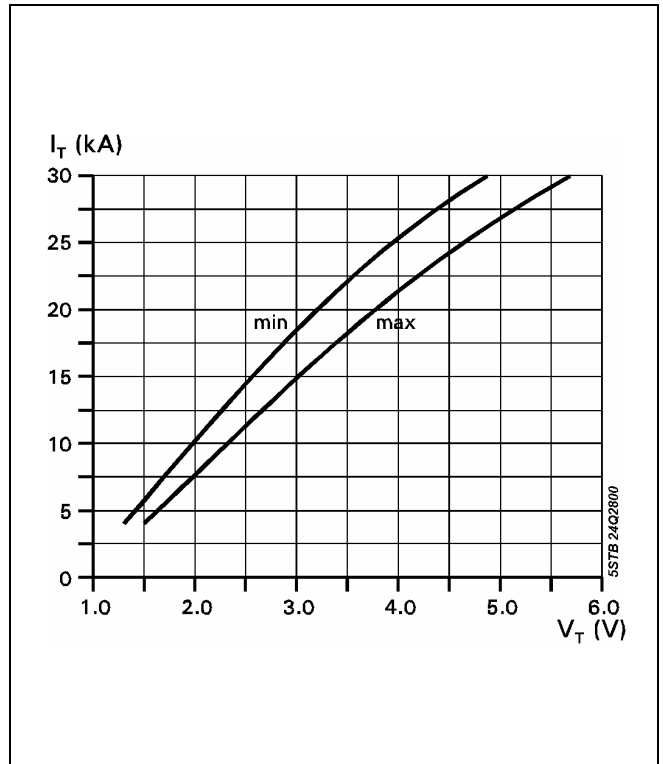

Fig. 3 On-state characteristics.  
T<sub>j</sub> = 125°C, 10ms half sine.

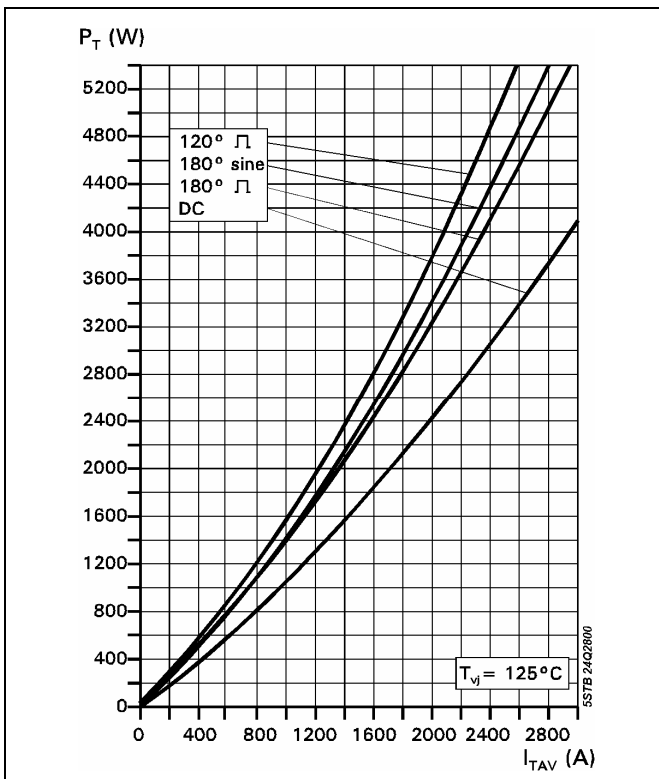

Fig. 4 On-state power dissipation vs. mean on-state current. Turn-on losses excluded.

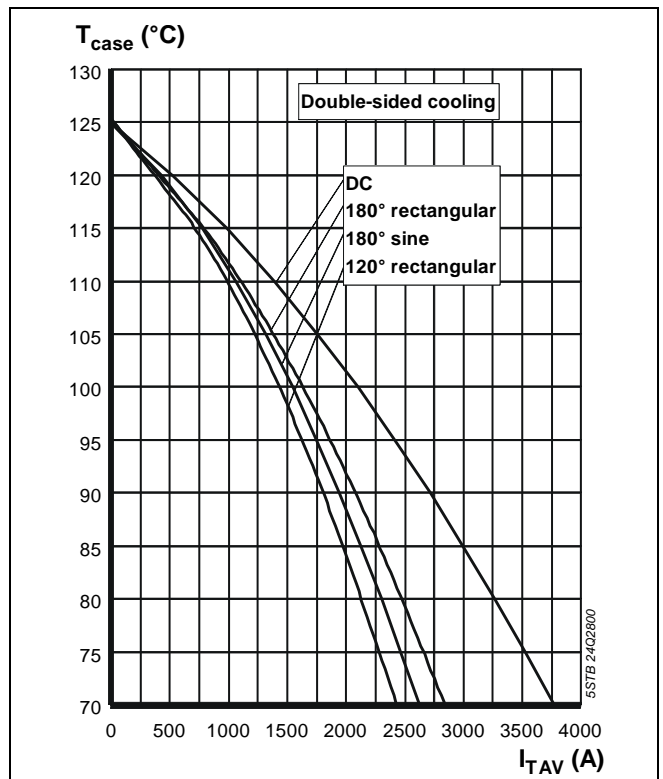

Fig. 5 Max. permissible case temperature vs. mean on-state current. Switching losses ignored.

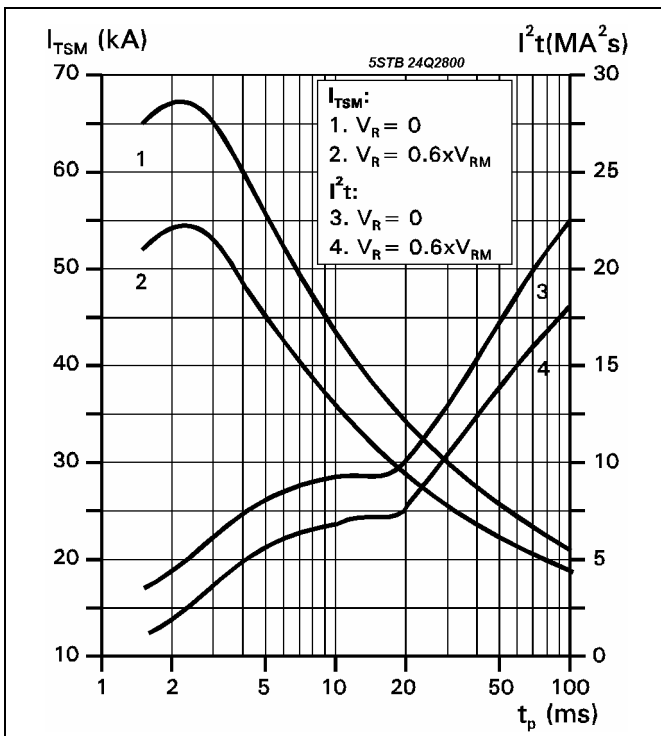

Fig. 6 Surge on-state current vs. pulse length. Half-sine wave.

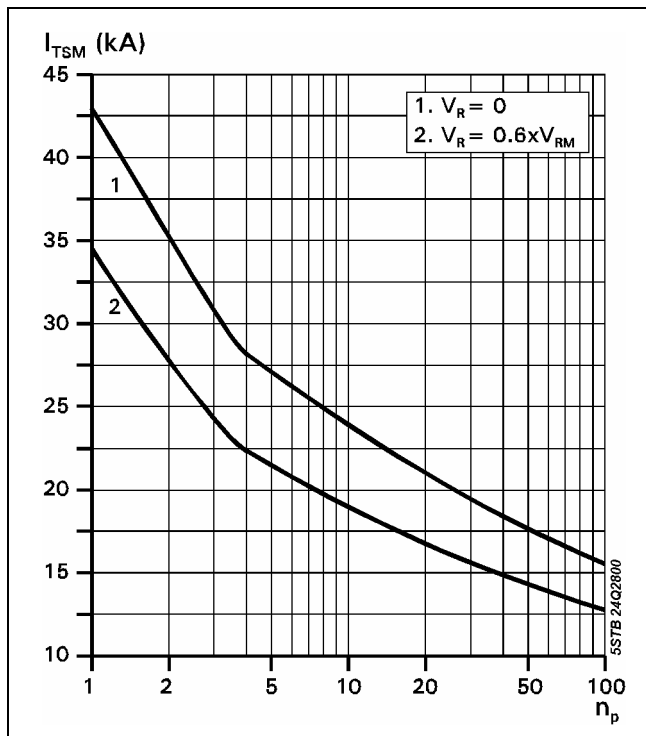

Fig. 7 Surge on-state current vs. number of pulses. Half-sine wave, 10 ms, 50Hz.

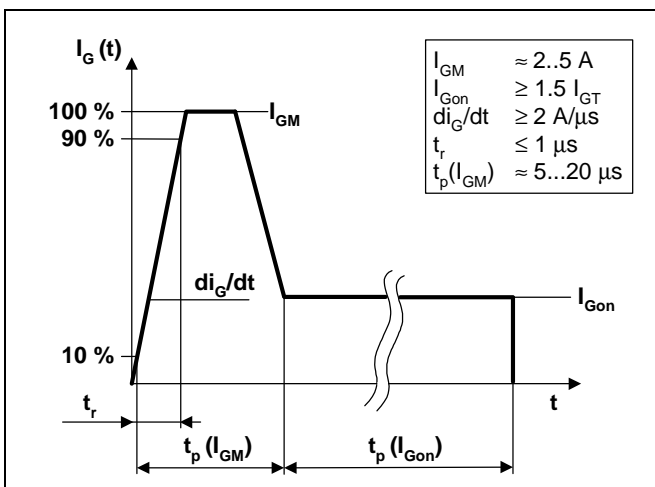

Fig. 8 Recommended gate current waveform

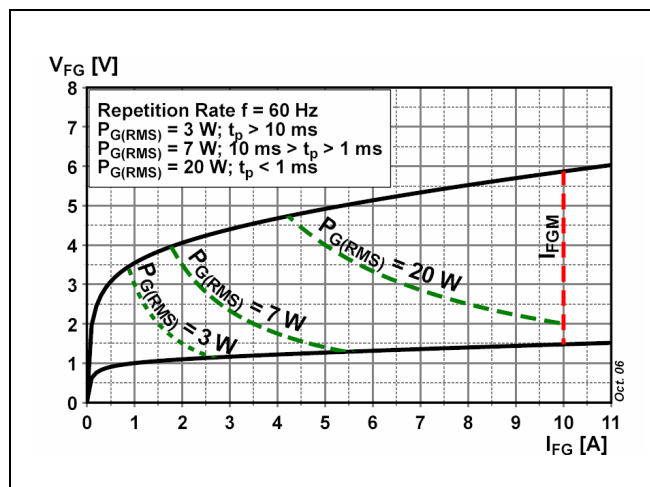

Fig. 9 Max. peak gate power loss

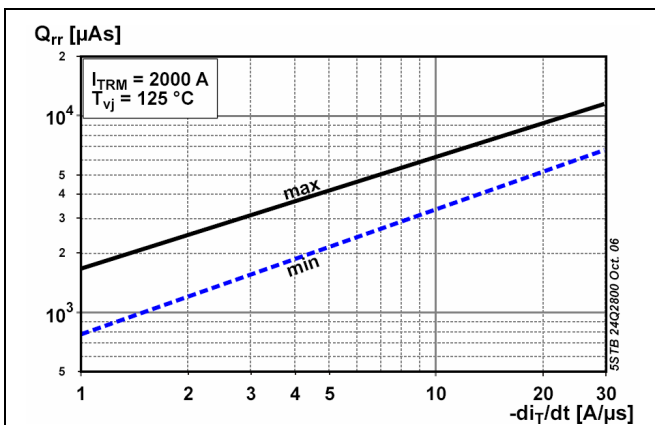

Fig. 10 Reverse recovery charge vs. decay rate of on-state current

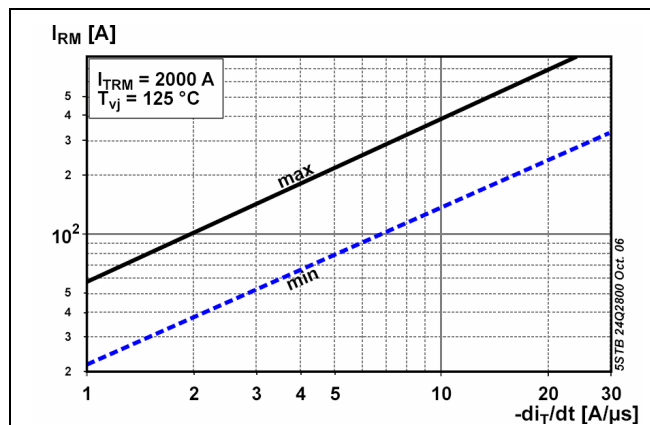

Fig. 11 Peak reverse recovery current vs. decay rate of on-state current

# Turn-on and Turn-off losses

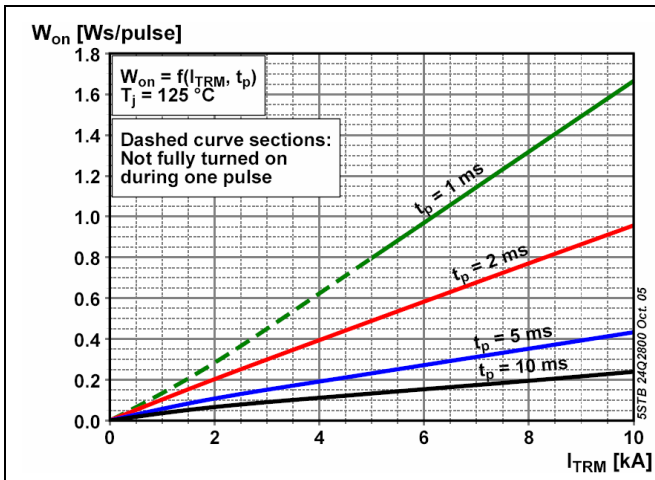

Fig. 12 Turn-on energy, half sinusoidal waves

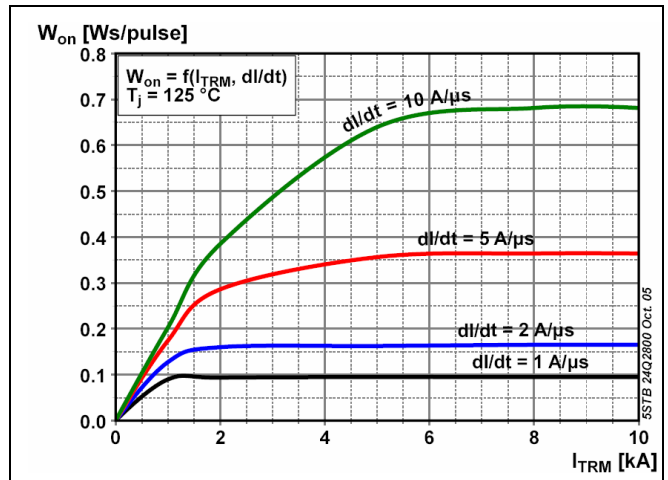

Fig. 13 Turn-on energy, rectangular waves

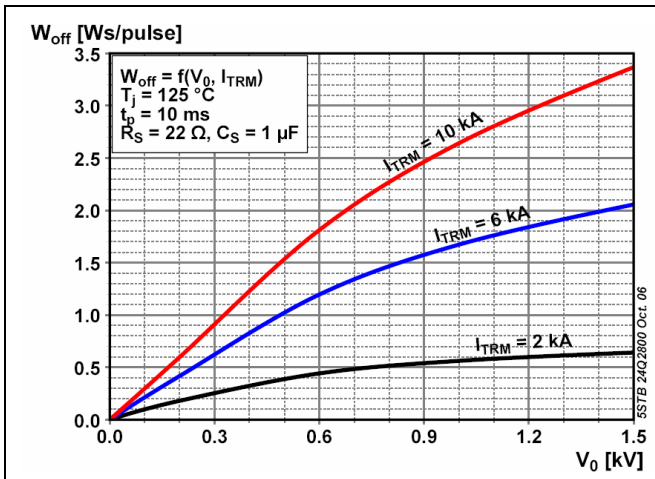

Fig. 14 Turn-off energy, half sinusoidal waves

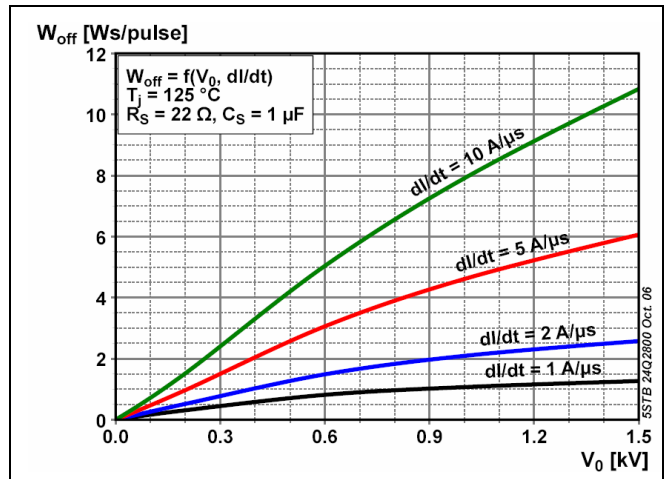

Fig. 15 Turn-off energy, rectangular waves

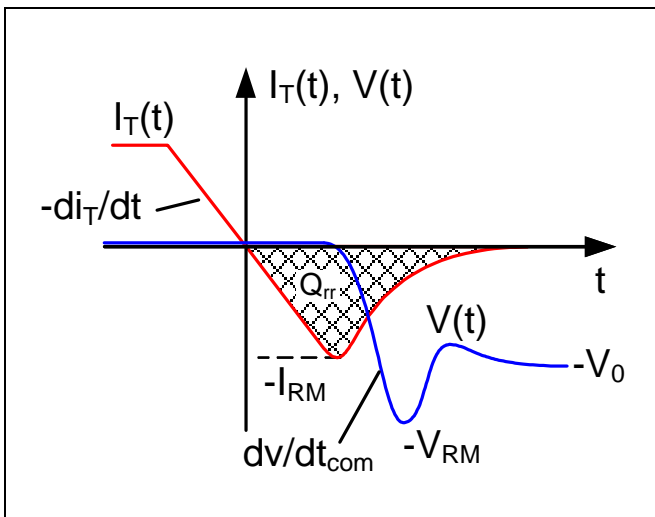

Fig. 16 Current and voltage waveforms at turn-off

**Total power loss for repetitive waveforms:**

$$P_{TOT} = P_T + W_{on} \cdot f + W_{off} \cdot f$$

where

$$P_T = \frac{1}{T} \int_0^T I_T \cdot V_T(I_T) dt$$

Fig. 17 Relationships for power loss

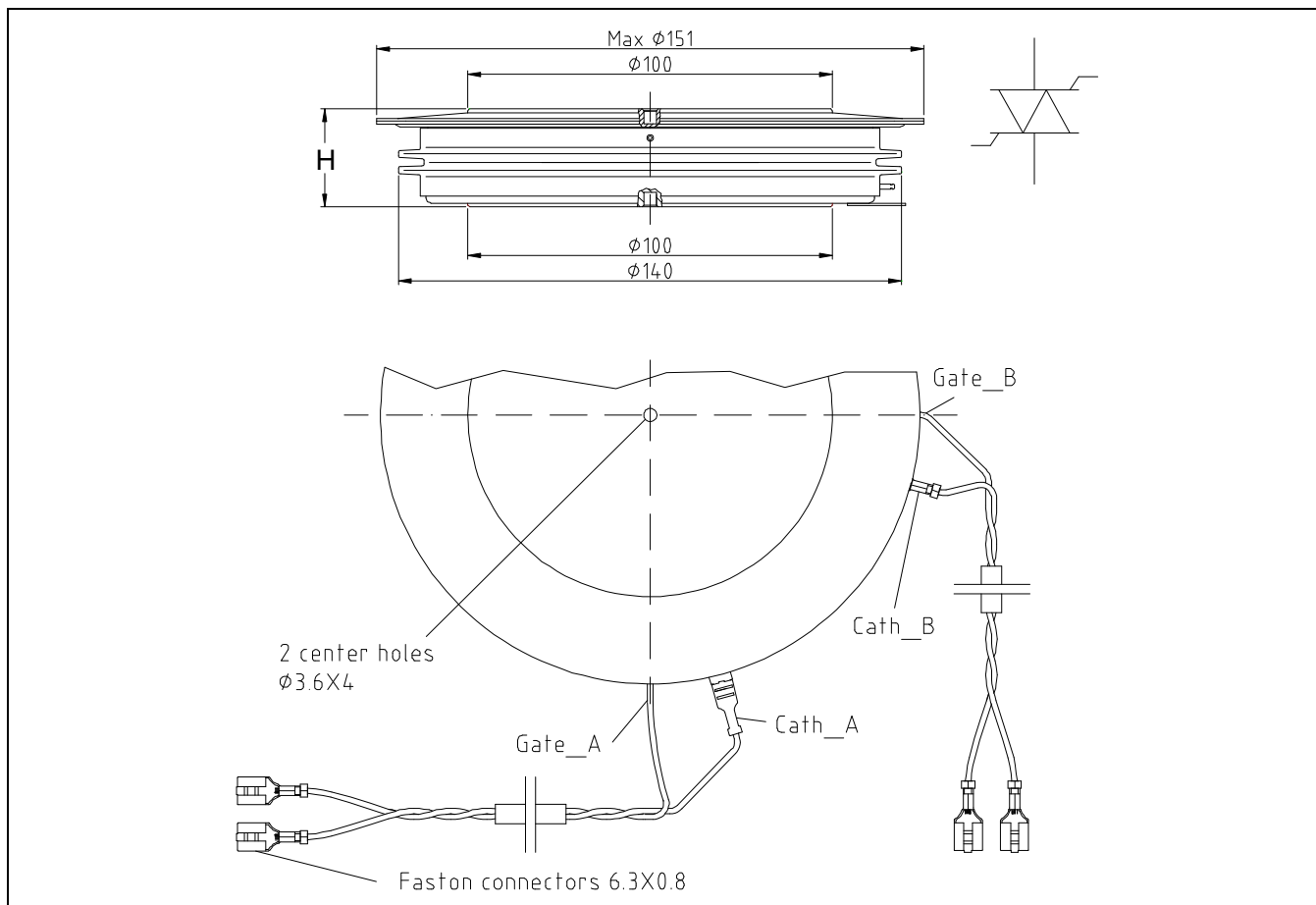

**Fig. 18** Device Outline Drawing

### Related documents:

5SYA 2020	Design of RC-Snubber for Phase Control Applications
5SYA 2049	Voltage definitions for phase control thyristors and diodes
5SYA 2051	Voltage ratings of high power semiconductors
5SYA 2034	Gate-Drive Recommendations for PCT's
5SYA 2036	Recommendations regarding mechanical clamping of Press Pack High Power Semiconductors
5SZK 9104	Specification of environmental class for pressure contact diodes, PCTs and GTO, STORAGE available on request, please contact factory
5SZK 9105	Specification of environmental class for pressure contact diodes, PCTs and GTO, TRANSPORTATION available on request, please contact factory

Please refer to <http://www.abb.com/semiconductors> for current version of documents.

**ABB Switzerland Ltd, Semiconductors reserves the right to change specifications without notice.**

# ABB

**ABB Switzerland Ltd**  
**Semiconductors**  
 Fabrikstrasse 3  
 CH-5600 Lenzburg, Switzerland

Doc. No. 5SYA1053-02 May 07

Telephone +41 (0)58 586 1419  
 Fax +41 (0)58 586 1306  
 Email [abbsem@ch.abb.com](mailto:abbsem@ch.abb.com)  
 Internet [www.abb.com/semiconductors](http://www.abb.com/semiconductors)