

COMPARISON GUIDE

ABB General Purpose Drives

ACS550 to ACS580 comparison guide

Wall-mount units frame R1-R9



Related documents

[ACS580 Standard Control Program Firmware Manual](#) publication number 3AXD50000016097

[ACS580-01 Drives Hardware Manual](#) publication number 3AXD50000044794

[ACS580 General Purpose Drives Catalog](#) publication number ACS580-PHTC01U-EN

Contents

2	Related documents
3	Contents
4	Using the comparison guide
5	Selecting and sizing the drive
8	Drive Options
9	Dimensions and comparison tables
14	Flange Kit Dimensions and Comparison Tables
15	Free space requirements
16	Cable sizes and power loss data
17	Heat/Power losses
19	Control terminal wiring
20	Parameter groups

Using the comparison guide

Important notice

This guide is intended for limited distribution to ABB's channel partners and customers who are replacing the ACS550 drive with the ACS580 General Purpose drive. ABB has prepared this document to aid sales associates, authorized channel partners and customers in the drive replacement. Every attempt has been made to ensure the accuracy of the information.

All installation and electrical work should be carried out by a trained professional. ABB takes no responsibility for any damages or other liability whatsoever (including any consequential damages, even if ABB or an ABB representative had advised of the possibility of such damages) resulting from the use or selection of this document for any information, apparatus, method, process, or similar item disclosed in this guide. Specification is subject to change without notice.

Before beginning, some basic checklist items

All information regarding the control of your application should be gathered from the ACS550 prior to selecting and performing the actual replacement, control and parameter settings should be noted to ensure consistency in the replacement ACS580.

This checklist covers the main information you may require to guide you through the replacement process. If the ACS550 cannot be powered, the technician should gather all the information below that is not parameter related.

ACS550 upgrade basics

- Record nominal power, current, voltage, etc. ratings taken from your motor nameplate (to use in the ratings comparison tables)
- What type of signal is the speed/frequency command? e.g. 0-10VDC, 4-20 mA, via communications, or other?
- Where is the speed/frequency command landed on the drive?
- What type of signal is the start/stop command? e.g. a relay closure, via communications, or other?
- Where is the start/stop command terminated on the drive?
- Are there any other control or reference sources that require additional IO options?
- Are you using a door-mounted control panel on an enclosure door? If so, consider appropriate kit/method for replacement keypad.
- Are you using a door-mounted control panel? Consider this when choosing options
- Consider the dimensions and mounting requirements, cable sizes and heat losses
- Review the control terminal wiring and ensure the cable lengths are sufficient
- Is the drive controlled by a communication protocol? e.g. Modbus TCP. If so, document the appropriate communication settings, such as MAC ID, Device Object Instance ID, Baud, etc.
- Are there any analog outputs from the drive that are wired to another device? If so, document the type of signal (e.g. 4-20 mA), where it was terminated on the drive, what it was used for, and any scaling of the signal.
- Are there any relay outputs from the drive that are wired to another device? If so, document where it was landed on the drive and what it was used for.
- Are there any other control or reference sources that require additional IO options?
- If the existing ACS550 is using an encoder module then the replacement must be an ACS880. The ACS580 does not offer an encoder card.
- If the existing ACS550 drive relies on a NEMA 4X control panel mounting kit, be aware that the equivalent is not available with the ACS580 at the time of this publication.
- If the existing ACS550 is controlled by a communication protocol, please contact ABB for Technical Assistance, Application Notes, and Add-on instructions since not all revisions are compatible.

This guide will help you to replace the ACS550 drive with the ACS580 General Purpose drive. Follow the steps outlined in this guide to find the optimal replacement product and to expedite the replacement process.

Step 1: Sizing of the drive and selecting options

Compare power range, mounting methods and dimensions to select the appropriate ACS580 product compared to the ACS550 drive, see the checklist items for some useful guidance.

Step 2: Wiring and parameter setup

Compare electrical data and basic parameter range for optimal replacement. Use the replacement ACS580 manual to assist with the commissioning process.

Selecting and sizing the drive

Type designation 200V-240V

1. Start with identifying type designation of your ACS550 drive.
2. Compare the motor's power and current rating from the ratings table below. For heavy-duty and other ratings, check Hardware Manual (see [Related documents](#)).
3. Compare the options on the options page.

Example:

ACS550	-	U1	-	017A	-	2	+	B055
ACS580	-	01	-	017A	-	2	+	B056

$U_1 = 208V$ to 240V 3-phase

Power ratings are valid at nominal output voltage 208V 50/60Hz

Power (HP)	Material Description	Current (A)	Base Drive Frame
1	ACS550-U1-04A6-2	4.6	R1
1.5	ACS550-U1-06A6-2	6.6	
2	ACS550-U1-07A5-2	7.5	
3	ACS550-U1-012A-2	11.8	
5	ACS550-U1-017A-2	16.7	
7.5	ACS550-U1-024A-2	24.2	R2
10	ACS550-U1-031A-2	30.8	
15	ACS550-U1-046A-2	46.2	R3
20	ACS550-U1-059A-2	59.4	
25	ACS550-U1-075A-2	74.8	R4
30	ACS550-U1-088A-2	88	
40	ACS550-U1-114A-2	114	
50	ACS550-U1-143A-2	143	R6
60	ACS550-U1-178A-2	178	
75	ACS550-U1-221A-2	221	
100	ACS550-U1-248A-2	248	

$U_1 = 208V$ 1-phase

Power ratings are valid at nominal output voltage 208V 50/60Hz

Power (HP)	Material Description	Current (A)	Base Drive Frame

The ACS550 -xx-xxxx-2 (208...240V series) can be used with a single phase supply, if output current is derated by 50%. Please note this rule does not apply to the ACS580; follow the next table instead.

$U_1 = 200V$ to 240V 3-phase

Power ratings are valid at $U_N = 208V/230V$ 50/60Hz

Base Drive Frame	Power (HP)	Material Description	Current (A)
R1	1	ACS580-01-04A6-2	4.6
	1.5	ACS580-01-06A6-2	6.6
	2	ACS580-01-07A5-2	7.5
	3	ACS580-01-10A6-2	10.6
	5	ACS580-01-017A-2	16.7
R2	7.5	ACS580-01-024A-2	24.2
	10	ACS580-01-031A-2	30.8
R3	15	ACS580-01-046A-2	46.2
	20	ACS580-01-059A-2	59.4
R4	25	ACS580-01-075A-2	74.8
R5	30	ACS580-01-088A-2	88
	40	ACS580-01-114A-2	114
R6	50	ACS580-01-143A-2	143
R7	60	ACS580-01-169A-2	169
	75	ACS580-01-211A-2	211
R8	100	ACS580-01-273A-2	273
R9	125	ACS580-01-343A-2	343
	150	ACS580-01-396A-2	396

$U_1 = 240V$ 1-phase

Power ratings are valid at $U_N = 230V$ 50/60Hz UL-approved

Base Drive Frame	Power (HP)	Material Description	Current (A)
R1	0.5	ACS580-01-04A6-2	2.2
	0.75	ACS580-01-06A6-2	3.2
	1	ACS580-01-07A5-2	4.2
	1.5	ACS580-01-10A6-2	6.0
	2	ACS580-01-017A-2	6.8
R2	3	ACS580-01-024A-2	9.6
	5	ACS580-01-031A-2	15.2
R3	7.5	ACS580-01-046A-2	22
	10	ACS580-01-059A-2	28
R4	10	ACS580-01-075A-2	28
R5	15	ACS580-01-088A-2	42
	20	ACS580-01-114A-2	54
R6	25	ACS580-01-143A-2	68
R7	30	ACS580-01-169A-2	80
	40	ACS580-01-211A-2	104
R8	50	ACS580-01-273A-2	130
R9	60	ACS580-01-343A-2	154
	75	ACS580-01-396A-2	192

Notes:

Ratings apply at an ambient temperature of 40°C (104°F) unless otherwise noted.

To achieve the rated motor power given in the table, the rated current of the drive must be higher than or equal to the rated motor current.

Definitions:

A Drive current, continuous RMS output current allowing 110% overload for 1 minute every 10 minutes.

HP Drive or package power, typical motor power

U_N Nominal output voltage of the drive

U_1 Input voltage range

Selecting and sizing the drive

Type designation 380V-480V

1. Start with identifying type designation of your ACS550 drive.
2. Compare the motor's power and current rating from the ratings table below. For heavy-duty and other ratings, check Hardware Manual (see [Related documents](#)).
3. Compare the options on the options page.

Example:

ACS550	-	U1	-	012A	-	4	+	B055
ACS580	-	01	-	012A	-	4	+	B056

$U_1 = 380V$ to $480V$ 3-phase

Power ratings are valid at nominal output voltage 460V 50/60Hz

Power (HP)	Material Description	Current (A)	Base Drive Frame
			R1
1-1.5	ACS550-U1-03A3-4	3.3	
2	ACS550-U1-04A1-4	4.1	
3	ACS550-U1-06A9-4	6.9	
5	ACS550-U1-08A8-4	8.8	
7.5	ACS550-U1-012A-4	11.9	
10	ACS550-U1-015A-4	15.4	R2
15	ACS550-U1-023A-4	23	
20	ACS550-U1-031A-4	31	R3
25	ACS550-U1-038A-4	38	
30	ACS550-U1-045A-4	44	
40	ACS550-U1-059A-4	59	R4
50	ACS550-U1-072A-4	72	
60	ACS550-U1-078A-4	77	
75	ACS550-U1-097A-4	96	
100	ACS550-U1-125A-4	124	R5
125	ACS550-U1-157A-4	157	R6
150	ACS550-U1-180A-4	180	
200	ACS550-U1-246A-4	245	

See notes and definitions on page 4

$U_1 = 380V$ to $480V$ 3-phase

Power ratings are valid at $U_N = 460V$ 50/60Hz

Base Drive Frame	Power (HP)	Material Description	Current (A)
R1	1	ACS580-01-02A1-4	2.1
	1.5	ACS580-01-03A0-4	3.0
	2	ACS580-01-03A5-4	3.5
	3	ACS580-01-04A8-4	4.8
	5	ACS580-01-07A6-4	7.6
	7.5	ACS580-01-012A-4	12
R2	10	ACS580-01-014A-4	14
	15	ACS580-01-023A-4	23
R3	20	ACS580-01-027A-4	27
	25	ACS580-01-034A-4	34
	30	ACS580-01-044A-4	44
R4	40	ACS580-01-052A-4	52
	50	ACS580-01-065A-4	65
	60	ACS580-01-077A-4	77
R5	75	ACS580-01-096A-4	96
R6	100	ACS580-01-124A-4	124
R7	125	ACS580-01-156A-4	156
	150	ACS580-01-180A-4	180
R8	200	ACS580-01-240A-4	240
R9	250	ACS580-01-302A-4	302
	300	ACS580-01-361A-4	361
	350	ACS580-01-414A-4	414

Consult factory

Selecting and sizing the drive

Type designation 500V-600V

1. Start with identifying type designation of your ACS550 drive.
2. Compare the motor's power and current rating from the ratings table below. For heavy-duty and other ratings, check Hardware Manual (see [Related documents](#)).
3. Compare the options on the options page.

Example:

ACS550	-	U1	-	011A	-	6	+	B055
ACS580	-	01	-	011A	-	6	+	B056

U_i = 500V to 600V 3-phase

Power ratings are valid at nominal output voltage 575V 50/60Hz

Power (HP)	Material Description	Current (A)	Base Drive Frame
2	ACS550-U1-02A7-6	2.7	R2
3	ACS550-U1-03A9-6	3.9	
5	ACS550-U1-06A1-6	6.1	
7.5	ACS550-U1-09A0-6	9.0	
10	ACS550-U1-011A-6	11	
15	ACS550-U1-017A-6	17	
20	ACS550-U1-022A-6	22	R3
25	ACS550-U1-027A-6	27	
30	ACS550-U1-032A-6	32	R4
40	ACS550-U1-041A-6	41	
50	ACS550-U1-052A-6	52	
60	ACS550-U1-062A-6	62	
75	ACS550-U1-077A-6	77	R6
100	ACS550-U1-099A-6	99	
125	ACS550-U1-125A-6	125	
150	ACS550-U1-144A-6	144	

U_i = 500V to 600V 3-phase

Power ratings are valid at U_N = 575V 50/60Hz

Base Drive Frame	Power (HP)	Material Description	Current (A)
R2	2	ACS580-01-02A7-6	2.7
	3	ACS580-01-03A9-6	3.9
	5	ACS580-01-06A1-6	6.1
	7.5	ACS580-01-09A0-6	9.0
	10	ACS580-01-011A-6	11
	15	ACS580-01-017A-6	17
R3	20	ACS580-01-022A-6	22
	25	ACS580-01-027A-6	27
	30	ACS580-01-032A-6	32
R5	40	ACS580-01-041A-6	41
	50	ACS580-01-052A-6	52
	60	ACS580-01-062A-6	62
	75	ACS580-01-077A-6	77
R7	100	ACS580-01-099A-6	99
	125	ACS580-01-125A-6	125
R8	150	ACS580-01-144A-6	144
R9	200	ACS580-01-192A-6	192
	250	ACS580-01-242A-6	242
	250	ACS580-01-271A-6	271

See notes and definitions on page 4

Drive Options

Identify your drive and options:

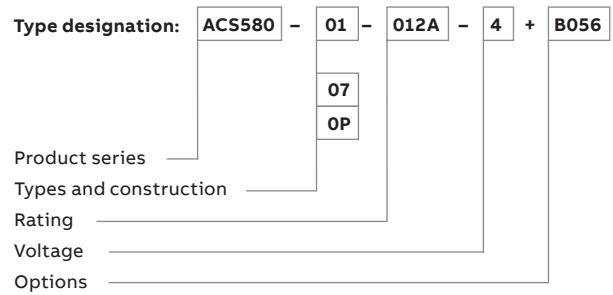
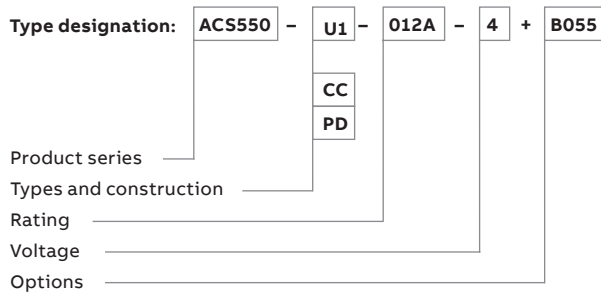

ACS550-U1		
Option name	Description	Available options and code
Degree of protection		
	UL (NEMA) Type 12 (IP54)	B055
Control panel		
ACS/H-CP-EXT	Panel Mounting Kit	x
ACS/H-CP-EXT-IP66	Panel Mounting Kit IP66	x
-	-	-
I/O options		
OREL-01	Relay Output Extension	+L511
OHDI-01	115/230V Digital Input 6xDI	+L512
Fieldbus		
RCNA-01	ControlNet™	+K462
RDNA-01	DeviceNet™	+K451
RETA-01	EtherNet/IP™	+K466
RPBA-01	PROFIBUS DP	+K454
Tools		
Drivewindow Light	DriveWindow Light and USB serial adapters	x
Braking chopper Standard in frames R1, R2		
o = standard with drive		
x = ordering with separate material code		

ACS580-01		
Replacement	Description	Option name
Degree of protection		
B056	UL (NEMA) Type 12 (IP55)	
Control panel		
-	Door Mounting Kit contains both DPMP-06 and CDPI-01	DPMP-06-EXT-H
-	-	-
+J429	Bluetooth Control Panel	ACS-AP-W
I/O options		
+L501	External 24V AC/DC 2xRO and 1xDO	CMOD-01*
+L512	115/230V Digital Input 6xDI and 2xDO	CHDI-01
Fieldbus		
x	ControlNet™	FCNA-01-KIT
+K451	DeviceNet™	FDNA-01-KIT
+K475	EtherNet/IP™ / Two Port	FENA-21-KIT
+K454	PROFIBUS DP	FBPA-01
Tools		
x	Cold Configurator Adapter	CCA-01
	Drive Composer Entry**	Download from www.abb.com/drives
x	Drive Composer Pro**	DCPT-01-KIT
x	DriveTune App for iOS/Android***	
Braking chopper Standard in frames R1, R2, R3		
USB programming through Local/Remote control panel		
* External +24V input for frames R1-R5 require CMOD-01.		
** Requires mini-USB cable to ABB Drive Control Panel		
*** Requires ACS-AP-W Bluetooth Control Panel		

Dimensions and comparison tables

ACS550-U1 UL (NEMA) Type 1 Wall-mounted drives up to 200 hp

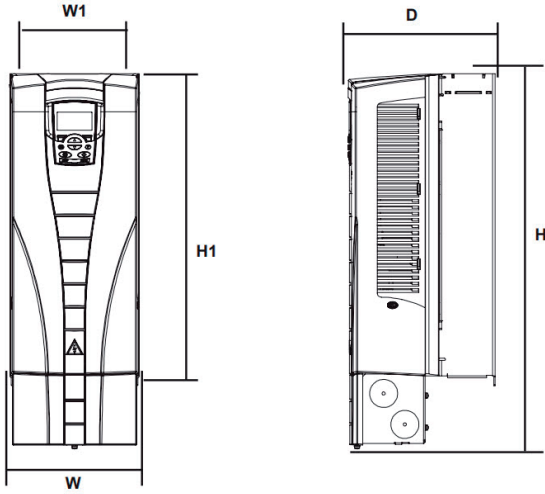

H = Height including conduit box
 H1 = Height to mounting centers
 W = Width
 W1 = Width to mounting centers

ACS580-01 UL (NEMA) Type 1 Wall-mounted drives up to 350 hp

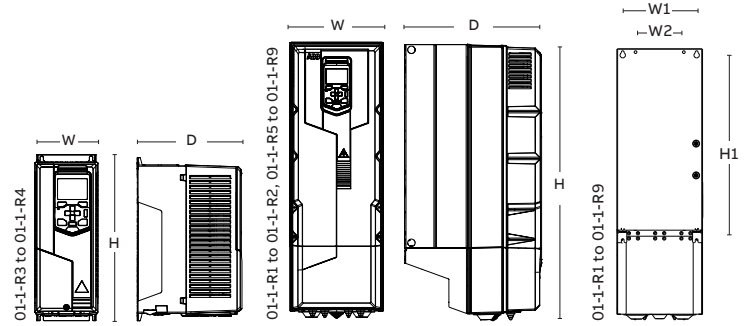

ACS580-01 with integrated conduit box (R3-R4)

ACS580-01 with removable conduit box (R1-R2, R5-R9)

ACS550-U1 wall-mounted UL (NEMA) Type 1 (All Voltages)				
Dim Ref	Height (H)	Width (W)	Depth (D)	Weight
	in	in	in	lb
Ux1-1	14.5	4.9	8.3	14.3
Ux1-2	18.5	4.9	8.7	19.8
Ux1-3	23.0	8.0	9.1	35.0
Ux1-4	27.1	8.0	10.3	53.0
Ux1-5	29.0	10.4	11.3	75.0
Ux1-6	34.6	11.8	15.8	152.0

ACS580-01, wall-mounted UL (NEMA) Type 1 (All Voltages)				
Dim Ref	Height (H)	Width (W)	Depth (D)	Weight
	in	in	in	lb
R1	14.69	4.92	8.78	10.1
R2	18.62	4.92	9.00	14.6
R3	19.29	7.99	9.02	26.0
R4	25.04	7.99	10.12	41.9
R5	28.82	7.99	11.61	62.4
R6	28.62	9.92	14.53	93.5
R7	34.65	11.18	14.57	119.1
R8	37.99	11.81	15.47	152.2
R9	37.60	14.96	16.46	213.9

ACS550-U1 mounting dimensions UL (NEMA) Type 1 (All Voltages)		
Dim Ref	Height (H1)	Width (W1)
	in	in
Ux1-1	12.5	3.9
Ux1-2	16.4	3.9
Ux1-3	18.6	6.3
Ux1-4	22.8	6.3
Ux1-5	23.2	9.4
Ux1-6	26.6	10.4

ACS580-01 mounting dimensions UL (NEMA) Type 1 (All Voltages)			
Dim Ref	Height (H1)	Width (W1)	Width (W2)
	in	in	in
R1	12.48	3.86	3.86
R2	16.42	3.86	3.86
R3	18.62	6.30	6.30
R4	24.37	6.30	3.86
R5	22.87	6.30	3.86
R6	20.91	8.37	6.30
R7	22.95	9.65	6.30
R8	25.91	10.33	8.43
R9	25.91	13.58	7.87

Dimensions and comparison tables

ACS550-U1 UL (NEMA) Type 12 (option +B055) Wall-mounted drives up to 200 hp

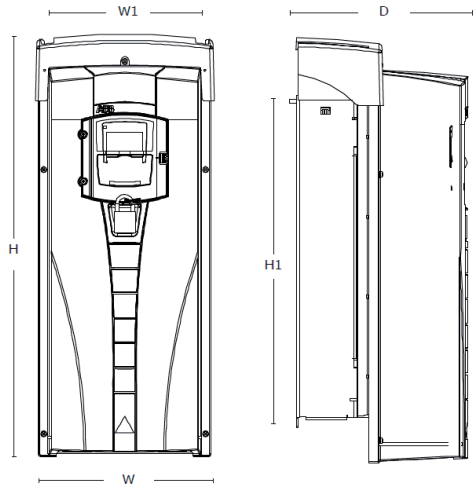

H = Height including conduit box
 H1 = Height to mounting centers
 W = Width
 W1 = Width to mounting centers

ACS550-U1 wall-mounted UL (NEMA) Type 12 (All Voltages)				
Dim Ref	Height (H)	Width (W)	Depth (D)	Weight
	in	in	in	lb
Ux12-1	18.1	8.7	9.2	18.0
Ux12-2	22.1	8.7	9.6	25.0
Ux12-3	24.8	10.5	10.0	41.0
Ux12-4	29.9	10.5	11.2	58.0
Ux12-5	30.5	14.5	12.1	85.0
Ux12-6	36.4	16.1	16.6	190.0

ACS550-U1 mounting dimensions UL (NEMA) Type 1 (All Voltages)		
Dim Ref	Height (H1)	Width (W1)
	in	in
Ux1-1	12.5	3.9
Ux1-2	16.4	3.9
Ux1-3	18.6	6.3
Ux1-4	22.8	6.3
Ux1-5	23.1	9.4
Ux1-6	26.6	10.4

ACS580-01 UL (NEMA) Type 12 (option +B056) Wall-mounted drives up to 350 hp

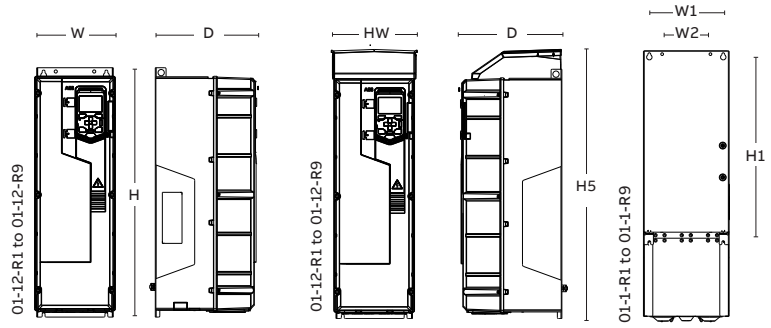

ACS580-01 without hood with integrated conduit box (R1-R9)

ACS580-01 with hood with integrated conduit box (R1-R9)

ACS580-01, wall-mounted UL (NEMA) Type 12 (All Voltages)					
Dim Ref	Height	Height (H5)	Width	Depth	Weight
	(in)	(in)	(in)	(in)	(lb)
R1	15.87	17.78	5.04	9.17	10.6
R2	19.80	21.49	5.04	9.41	15.0
R3	19.29	20.93	8.11	9.33	28.7
R4	25.04	27.03	7.99	10.43	44.1
R5	28.82	32.01	7.99	12.60	64.0
R6	28.62	34.81	9.92	14.96	94.8
R7	34.65	40.86	11.18	15.00	123.5
R8	37.99	44.23	11.81	17.80	169.8
R9	37.60	46.75	14.96	18.78	227.1

ACS580 mounting dimensions UL (NEMA) Type 12 (All Voltages)			
Dim Ref	Height (H1)	Width (W1)	Width (W2)
	in	in	in
R1	12.48	3.86	3.86
R2	16.42	3.86	3.86
R3	18.62	6.30	6.30
R4	24.37	6.30	3.86
R5	22.87	6.30	3.86
R6	20.91	8.37	6.30
R7	22.95	9.65	6.30
R8	25.91	10.33	8.43
R9	25.91	13.58	7.87

Dimensions and comparison tables

ACS550-PC and ACS550-PD, packaged drive with disconnect means, UL (NEMA) Type 1

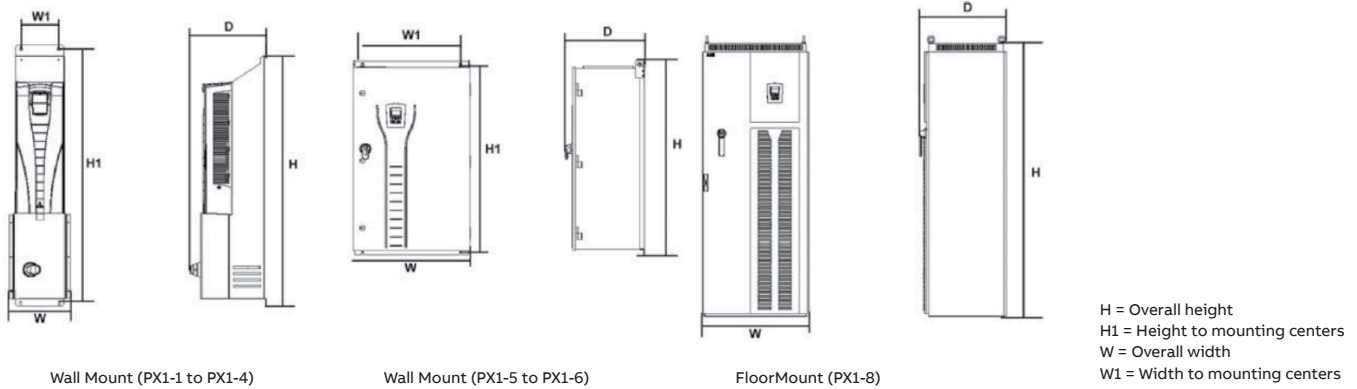

ACS580-OP, packaged drive with disconnect means, UL (NEMA) Type 1

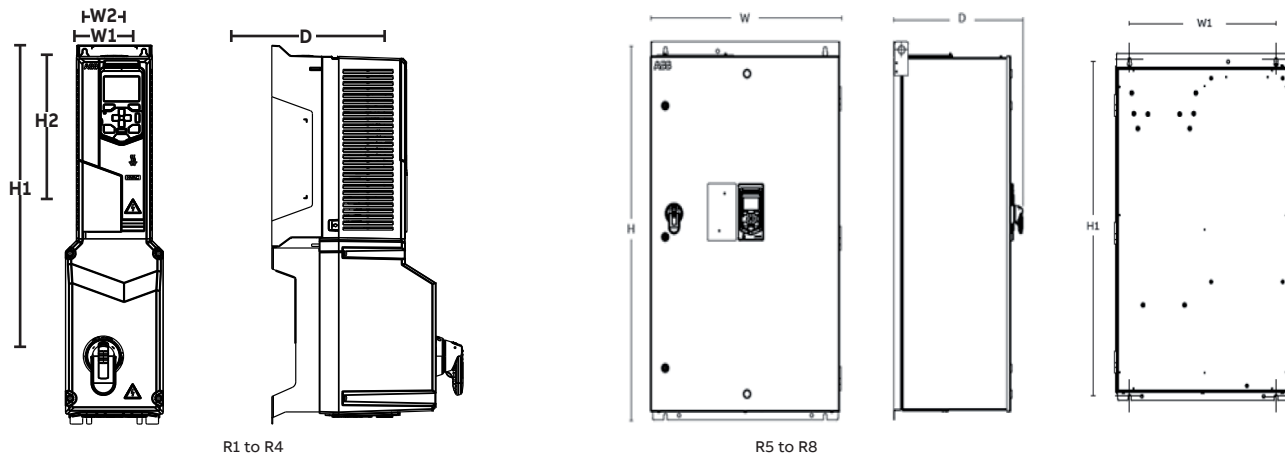

ACS550-PC and ACS550-PD, packaged drive with disconnect means, UL (NEMA) Type 1 (All Voltages)						
Dim Ref	Height (H1)	Width (W1)	Height (H)	Width (W)	Depth (D)	Weight
	in	in	in	in	in	lb
PX1-1	28.0	3.9	28.7	7.8	11.2	33
PX1-2	32.0	3.9	32.6	7.8	11.2	42
PX1-3	38.7	6.3	39.9	10.2	11.9	75
PX1-4	44.0	6.3	45.2	10.2	13.1	95
PX1-5	46.3	23.6	47.7	28.1	19.0	267
PX1-6	46.3	23.6	47.7	28.1	19.0	359
PX1-8	Free standing		83.7	31.7	25.9	794

ACS580-OP, packaged drive with disconnect means, UL (NEMA) Type 1 (All Voltages)						
Dim Ref	Height (H2)	Width (W2)	Height (H1)	Width (W1)	Depth (D)	Weight
	in	in	in	in	in	lb
R1	12.48	3.86	24.60	6.34	12.42	18.1
R2	16.42	3.86	28.49	6.34	12.63	22.0
R3	18.75	6.30	34.86	8.39	13.22	39.0
R4	24.49	6.30	40.61	8.39	14.26	60.0
R5-R8	46.26		47.72	28.24	19.04	359.0

Dimensions and comparison tables

ACS550-PC and ACS550-PD, packaged drive with disconnect means, UL (NEMA) Type 12

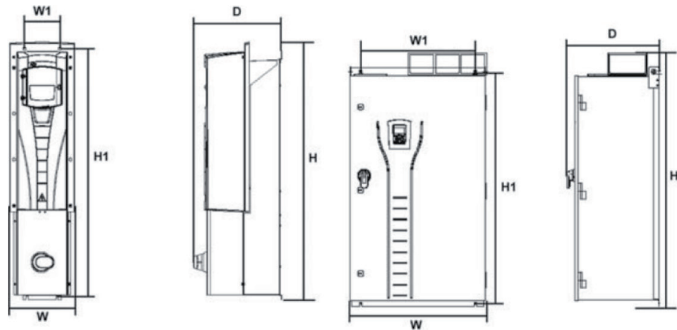

Wall Mount (PX12-1 to PX12-4)

Wall Mount (PX12-5 to PX12-6)

H = Overall height
 H1 = Height to mounting centers
 W = Overall width
 W1 = Width to mounting centers

ACS580-0P, packaged drive with disconnect means, UL (NEMA) Type 12

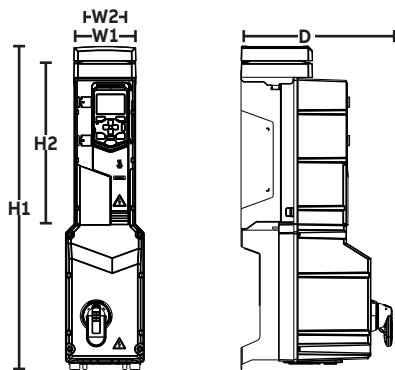

R1 to R4

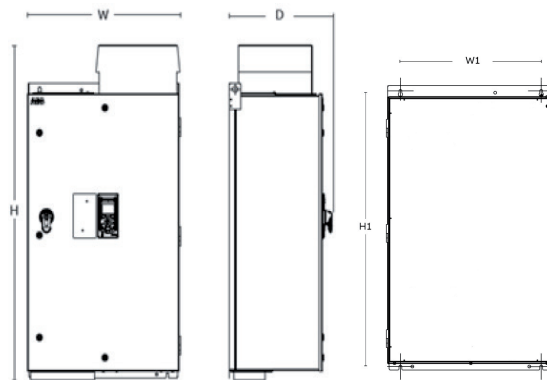

R5 to R8

ACS550-PC and ACS550-PD, packaged drive with disconnect means, UL (NEMA) Type 12 (All Voltages)						
Dim Ref	Height (H1)	Width (W1)	Height (H)	Width (W)	Depth (D)	Weight
	in	in	in	in	in	lb
PX12-1	28.0	3.9	29.3	8.7	11.2	37.0
PX12-2	32.0	3.9	33.2	8.7	11.6	46.0
PX12-3	38.7	6.3	40.6	10.5	11.9	79.0
PX12-4	44.0	6.3	45.8	10.5	13.1	99.0
PX12-5	46.3	23.6	54.3	28.1	19.0	267.0
PX12-6	46.3	23.6	54.3	28.1	19.0	359.0
PX12-8	Free standing		93.6	31.7	25.9	838.0

ACS580-0P, packaged drive with disconnect means, UL (NEMA) Type 12 (All Voltages)						
Dim Ref	Height (H2)	Width (W2)	Height (H1)	Width (W1)	Depth (D)	Weight
	in	in	in	in	in	lb
R1	12.48	3.86	26.50	6.50	12.40	18.1
R2	16.42	3.86	30.22	6.50	12.64	22.0
R3	18.75	6.30	36.51	8.39	13.22	39.0
R4	24.49	6.30	42.54	8.39	14.26	60.0
R5-R8	46.26	23.62	48.07	28.24	19.04	359.0

Dimensions and comparison tables

ACS550-PC and ACS550-PD, packaged drive with disconnect means, UL (NEMA) Type 3R

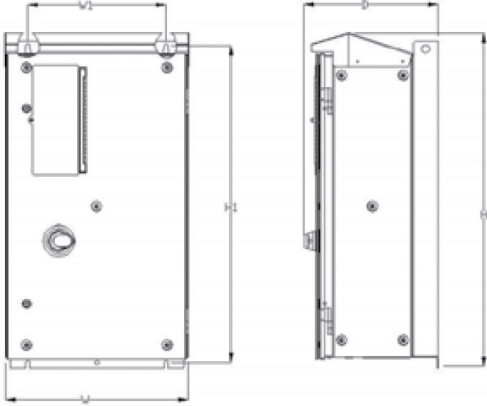

H = Overall height
 H1 = Height to mounting centers
 W = Overall width
 W1 = Width to mounting centers

Wall Mount (PX3R-1 to PX3R-6)

ACS580-0P, packaged drive with disconnect means, UL (NEMA) Type 3R

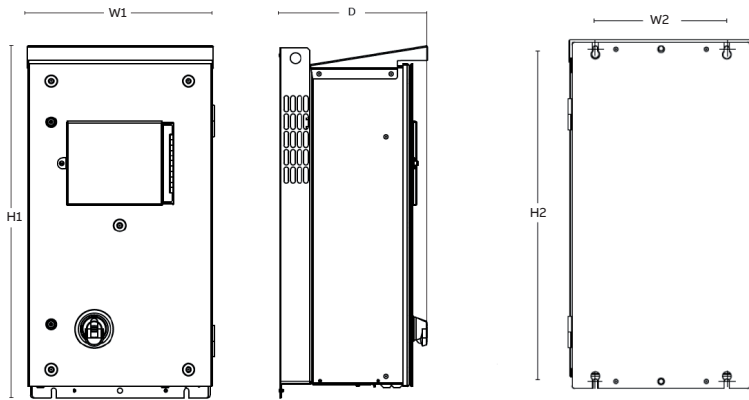

H1 = Overall height
 H2 = Height to mounting centers
 W1 = Overall width
 W2 = Width to mounting centers

R1 to R4

ACS550-PC and ACS550-PD, packaged drive with disconnect means, UL (NEMA) Type 3R (All Voltages)

Dim Ref	Height (H1)	Width (W1)	Height (H)	Width (W)	Depth (D)	Weight
	in	in	in	in	in	lb
PX3R-1	31.9	12.6	34.0	17.8	13.5	128.0
PX3R-2	31.9	12.6	34.0	17.8	13.5	134.0
PX3R-3	36.1	15.7	38.1	20.9	15.3	176.0
PX3R-4	36.1	15.7	38.1	20.9	15.3	194.0
PX3R-5	34.5	28.5	39.0	30.0	15.5	203.0
PX3R-6	46.5	34.5	51.0	36.0	21.5	395.0

ACS580-0P, packaged drive with disconnect means, UL (NEMA) Type 3R (All Voltages)

Dim Ref	Height (H1)	Width (W1)	Height (H2)	Width (W2)	Depth (D)	Weight
	in	in	in	in	in	lb
R1, R2	31.90	12.60	33.35	17.70	13.98	77.0
R3, R4	39.30	15.70	40.71	20.71	15.40	176.0

Flange Kit Dimensions and Comparison Tables



ACS550 (All Voltages)				
Flange Kit	Cutout Height (H1) in	Cutout Width (W1) in	Outer Dim Height (H) in	Outer Dim Width (W) in
FMK-A-R1	15.75	5.67	17.01	8.11
FMK-A-R2	18.58	5.67	20.95	8.11
FMK-A-R3	21.02	8.58	23.39	9.81
FMK-A-R4	26.30	8.58	28.54	9.81
FMK-B-R1	15.75	5.67	17.01	8.11
FMK-B-R2	18.58	5.67	20.95	8.11
FMK-B-R3	21.02	8.58	23.39	9.81
FMK-B-R4	26.30	8.58	28.54	9.81

ACS580 (All Voltages)				
Flange Kit	Cutout Height (H1) in	Cutout Width (W1) in	Outer Dim Height (H) in	Outer Dim Width (W) in
FMK-A/B-R1	16.10	5.91	18.15	8.11
FMK-A/B-R2	19.65	5.91	21.69	8.11
FMK-A/B-R3	21.65	9.06	24.13	11.42
FMK-A/B-R4	27.40	9.06	30.55	11.42
FMK-A/B-R5	27.42	9.06	30.55	11.42
FMK-A/B-R6	23.43	11.73	26.46	14.72
FMK-A/B-R7	25.47	12.99	28.43	15.98
FMK-A/B-R8	28.62	13.62	32.05	17.06
FMK-A/B-R9	28.62	16.73	31.65	19.76

Free space requirements

Vertically mounted side by side
ACS550-U1 UL (NEMA) Type 1/12
R1..R6

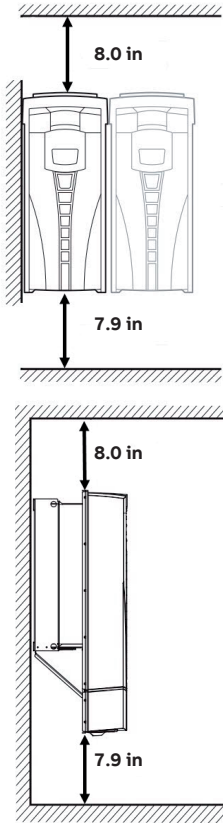

Vertically mounted side by side
ACS580-01 UL (NEMA) Type 1/12

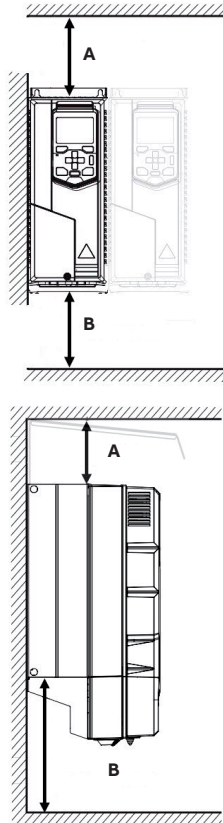

Vertically mounted alone
ACS550-U1 UL (NEMA) Type 1/12
R1..R6

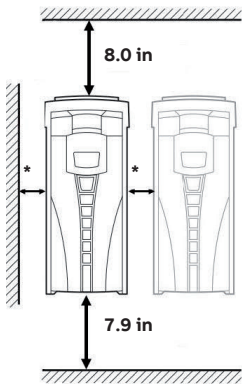

* Any

Vertically mounted alone
ACS580-01 UL (NEMA) Type 1/12

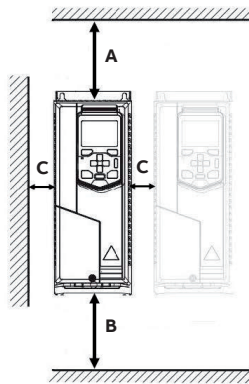

ACS580 Vertically Mounted Side by Side Free Space

Frame Size	Vertical Installation Free Space	
	Above A ¹ (in)	Below B ² (in)
R1	7.87	7.87
R2	7.87	7.87
R3	7.87	7.87
R4	7.87	7.87
R5	7.87	7.87
R6	7.87	11.81
R7	7.87	11.81
R8	7.87	11.81
R9	7.87	11.81

1) Free space above is measured from the frame, not from the hood used in UL (NEMA) Type 12 frames.

Note: The height of the hood for frames R4 and R9 exceeds the requirement for free space above in these frames.

	Frame R4	Frame R9
Hood Height (in)	2.83	9.06

2) Free space below is always measured from the drive frame, not from the conduit box

ACS580 Vertically Mounted Alone Free Space

Frame Size	Vertical Installation Free Space		
	Above A ¹ (in)	Below B ² (in)	Beside C ³ (in)
R1	5.91	3.39	5.91
R2	5.91	3.39	5.91
R3	7.87	2.09	5.91
R4	2.09	7.87	5.91
R5	3.94	7.87	5.91
R6	6.10	11.81	5.91
R7	6.10	11.81	5.91
R8	6.10	11.81	5.91
R9	7.87	11.81	5.91

1) Free space above is measured from the frame, not from the hood used in UL (NEMA) Type 12 frames.

Note: The height of the hood for frames R4 and R9 exceeds the requirement for free space above in these frames.

	Frame R4	Frame R9
Hood Height (in)	2.83	9.06

2) Free space below is always measured from the drive frame, not from the conduit box

3) Free space between the drive and other objects, e.g walls

Cable sizes and power loss data

Low installation sites and box installations

When replacing ACS550 with ACS580 you should consider the cabling lengths since the absence of conduit in ACS580 frames R3 and smaller may require you to lower the mounting points if the cable does not have sufficient stretch. Frames R6 and larger must have 11.8 inches free space below the drive – measured from the fan which is higher than the free space requirement on ACS550. This might require use of longer cables, or mounting clearances.

Horizontal cabling

Also notice that while ACS550 has multiple inlets on the bottom and on the sides of the conduit, the ACS580 has only five inlets which are located solely under the drive. This must be considered when replacing the ACS550 with the ACS580.

Maximum size diameter (AWG)

ACS550		ACS580	
Frame size	Stranded	Stranded	Frame size
R1	8	10	R1
R2	8	6	R2
R3	3	2	R3
R4	1/0	1	R4
R5	2/0	2/0	R5
R6	350 MCM	300 MCM	R6
-		500 MCM	R7
-		2 x 300 MCM	R8
-		2 x 500 MCM	R9

The following type codes have smaller maximum cable sizes than their compared ACS550*:

	HP	Type	A	ACS550 Max AWG	ACS580 Max AWG
208/230V					
R1	1	ACS580-01-04A6-2	4.6	8	10
	1.5	ACS580-01-06A6-2	6.6	8	10
	2	ACS580-01-07A5-2	7.5	8	10
	3	ACS580-01-10A6-2	10.6	8	10
	5	ACS580-01-017A-2	16.7	8	10
R4	25	ACS580-01-075A-2	74.8	1/0	1
R6	50	ACS580-01-143A-2	143	350 MCM	300 MCM
460V					
R1	1	ACS580-01-02A1-4	2.1	8	10
	1.5	ACS580-01-03A0-4	3.0	8	10
	2	ACS580-01-03A5-4	3.5	8	10
	3	ACS580-01-04A8-4	4.8	8	10
	5	ACS580-01-07A6-4	7.6	8	10
	7.5	ACS580-01-012A-4	12	8	10
R4	40	ACS580-01-052A-4	52	1/0	1
	50	ACS580-01-065A-4	65	1/0	1
	60	ACS580-01-077A-4	77	1/0	1
600V					
R3	30	ACS580-01-032A-6	32	3	2
R5	75	ACS580-01-077A-6	77	350 MCM	2/0

* Data only applicable to ACS550-01 and ACS580-01

Heat/Power losses

U₁ = 208V to 240V 3-phase

Power ratings are valid at nominal output voltage 208V 50/60Hz

Base Drive Frame	Hp	Material Description	Max heat dissipation (W)	Air Flow m ³ /hr	Air Flow ft ³ /min
R1	1	ACS550-U1-04A6-2	55	44	26
	1.5	ACS550-U1-06A6-2	73	44	26
	2	ACS550-U1-07A5-2	81	44	26
	3	ACS550-U1-012A-2	116	44	26
	5	ACS550-U1-017A-2	161	44	26
R2	7.5	ACS550-U1-024A-2	227	88	52
	10	ACS550-U1-031A-2	285	88	52
R3	15	ACS550-U1-046A-2	420	134	79
	20	ACS550-U1-059A-2	536	134	79
R4	25	ACS550-U1-075A-2	671	280	165
	30	ACS550-U1-088A-2	786	280	165
	40	ACS550-U1-114A-2	1014	280	165
R6	50	ACS550-U1-143A-2	1268	405	238
	60	ACS550-U1-178A-2	1575	405	238
	75	ACS550-U1-221A-2	1952	405	238
	100	ACS550-U1-248A-2	2189	405	238

U₁ = 380V to 480V 3-phase

Power ratings are valid at nominal output voltage 460V 50/60Hz

Base Drive Frame	Hp	Material Description	Max heat dissipation (W)	Air Flow m ³ /hr	Air Flow ft ³ /min
R1	1	ACS550-U1-03A3-4	40	44	26
	1.5	ACS550-U1-03A3-4	40	44	26
	2	ACS550-U1-04A1-4	52	44	26
	3	ACS550-U1-06A9-4	97	44	26
	5	ACS550-U1-08A8-4	127	44	26
	7.5	ACS550-U1-012A-4	172	44	26
R2	10	ACS550-U1-015A-4	232	88	52
	15	ACS550-U1-023A-4	337	88	52
R3	20	ACS550-U1-031A-4	457	134	79
	25	ACS550-U1-038A-4	562	134	79
	30	ACS550-U1-045A-4	667	134	79
R4	40	ACS550-U1-059A-4	907	280	165
	50	ACS550-U1-072A-4	1120	280	165
	60	ACS550-U1-078A-4	1295	280	165
	75	ACS550-U1-097A-4	1440	280	165
R5	100	ACS550-U1-125A-4	1940	168	238
R6	125	ACS550-U1-157A-4	2310	405	238
	150	ACS550-U1-180A-4	2810	405	238
	200	ACS550-U1-246A-4	3260	405	238
R8	250	ACS550-U1-316A-4*			
	300	ACS550-U1-368A-4*			
	350	ACS550-U1-414A-4*			

* floor standing so not direct comparison to ACS580 wall mounted drives

U₁ = 200V to 240V 3-phase

Power ratings are valid at U_n = 208V/230V 50/60Hz

Base Drive Frame	Hp	Material Description	Max heat dissipation (W)	Air Flow m ³ /hr	Air Flow ft ³ /min
R1	1	ACS580-01-04A6-2	50	43	25
	1.5	ACS580-01-06A6-2	69	43	25
	2	ACS580-01-07A5-2	79	43	25
	3	ACS580-01-10A6-2	120	43	25
	5	ACS580-01-017A-2	203	43	25
R2	7.5	ACS580-01-024A-2	247	101	59
	10	ACS580-01-031A-2	348	101	59
R3	15	ACS580-01-046A-2	518	179	105
	20	ACS580-01-059A-2	762	179	105
R4	25	ACS580-01-075A-2	809	288	170
R5	30	ACS580-01-088A-2	861	139	82
	40	ACS580-01-114A-2	1268	139	82
R6	50	ACS580-01-143A-2	1916	435	256
	60	ACS580-01-169A-2	1965	450	265
R7	75	ACS580-01-211A-2	2089	450	265
	100	ACS580-01-273A-2	3518	550	324
R9	125	ACS580-01-343A-2	2547	1150	677
	150	ACS580-01-396A-2	3060	1150	677

U₁ = 380V to 480V 3-phase

Power ratings are valid at U_n = 460V 50/60Hz

Base Drive Frame	Hp	Material Description	Max heat dissipation (W)	Air Flow m ³ /hr	Air Flow ft ³ /min
R1	1	ACS580-01-02A1-4	37	43	25
	1.5	ACS580-01-03A0-4	47	43	25
	2	ACS580-01-03A5-4	52	43	25
	3	ACS580-01-04A8-4	71	43	25
	5	ACS580-01-07A6-4	103	43	25
	7.5	ACS580-01-012A-4	200	43	25
R2	10	ACS580-01-014A-4	186	101	59
	15	ACS580-01-023A-4	342	101	59
R3	20	ACS580-01-027A-4	386	179	105
	25	ACS580-01-034A-4	446	179	105
	30	ACS580-01-044A-4	656	179	105
R4	40	ACS580-01-052A-4	671	134	79
	50	ACS580-01-065A-4	719	134	79
	60	ACS580-01-077A-4	1047	288	79
R5	75	ACS580-01-096A-4	1127	139	82
R6	100	ACS580-01-124A-4	1563	435	256
R7	125	ACS580-01-156A-4	1815	450	265
	150	ACS580-01-180A-4	2285	450	265
R8	200	ACS580-01-240A-4	3039	550	324
R9	250	ACS580-01-302A-4	3253	1150	677
	300	ACS580-01-361A-4	4836	1150	677
	350	ACS580-01-414A-4	5691	1150	677

See notes and definitions on page 4

Heat/Power losses

$U_1 = 500V$ to 600V 3-phase

Power ratings are valid at nominal output voltage 575V 50/60Hz

Base Drive Frame	Hp	Material Description	Max heat dissipation (W)	Air Flow m ³ /hr	Air Flow ft ³ /min
R2	2	ACS550-U1-02A7-6	46	88	52
	3	ACS550-U1-03A9-6	68	88	52
	5	ACS550-U1-06A1-6	124	88	52
	7.5	ACS550-U1-09A0-6	170	88	52
	10	ACS550-U1-011A-6	232	88	52
	15	ACS550-U1-017A-6	337	88	52
R3	20	ACS550-U1-022A-6	457	134	79
	25	ACS550-U1-027A-6	562	134	79
R4	30	ACS550-U1-032A-6	667	280	165
	40	ACS550-U1-041A-6	907	280	165
	50	ACS550-U1-052A-6	1120	280	165
	60	ACS550-U1-062A-6	1295	280	165
R6	75	ACS550-U1-077A-6	1504	405	238
	100	ACS550-U1-099A-6	1821	405	238
	125	ACS550-U1-125A-6	2442	405	238
	150	ACS550-U1-144A-6	2813	405	238

$U_1 = 500V$ to 600V 3-phase

Power ratings are valid at $U_N = 575V$ 50/60Hz

Base Drive Frame	Hp	Material Description	Max heat dissipation (W)	Air Flow m ³ /hr	Air Flow ft ³ /min
R2	2	ACS580-01-02A7-6	66	101	59
	3	ACS580-01-03A9-6	84	101	59
	5	ACS580-01-06A1-6	133	101	59
	7.5	ACS580-01-09A0-6	174	101	59
	10	ACS580-01-011A-6	228	101	59
	15	ACS580-01-017A-6	322	101	59
R3	20	ACS580-01-022A-6	430	179	105
	25	ACS580-01-027A-6	525	179	105
	30	ACS580-01-032A-6	619	139	82
R5	40	ACS580-01-041A-6	835	139	82
	50	ACS580-01-052A-6	1024	139	82
	60	ACS580-01-062A-6	1240	139	82
	75	ACS580-01-077A-6	1510	139	82
R7	100	ACS580-01-099A-6	2061	450	265
	125	ACS580-01-125A-6	2466	450	265
R8	150	ACS580-01-144A-6	3006	550	265
R9	200	ACS580-01-192A-6	4086	1150	324
	200	ACS580-01-242A-6	4086	1150	677
	250	ACS580-01-271A-6	4896	1150	677

See notes and definitions on page 4

Control terminal wiring

ACS550 to ACS580 I/O terminals using Defaults

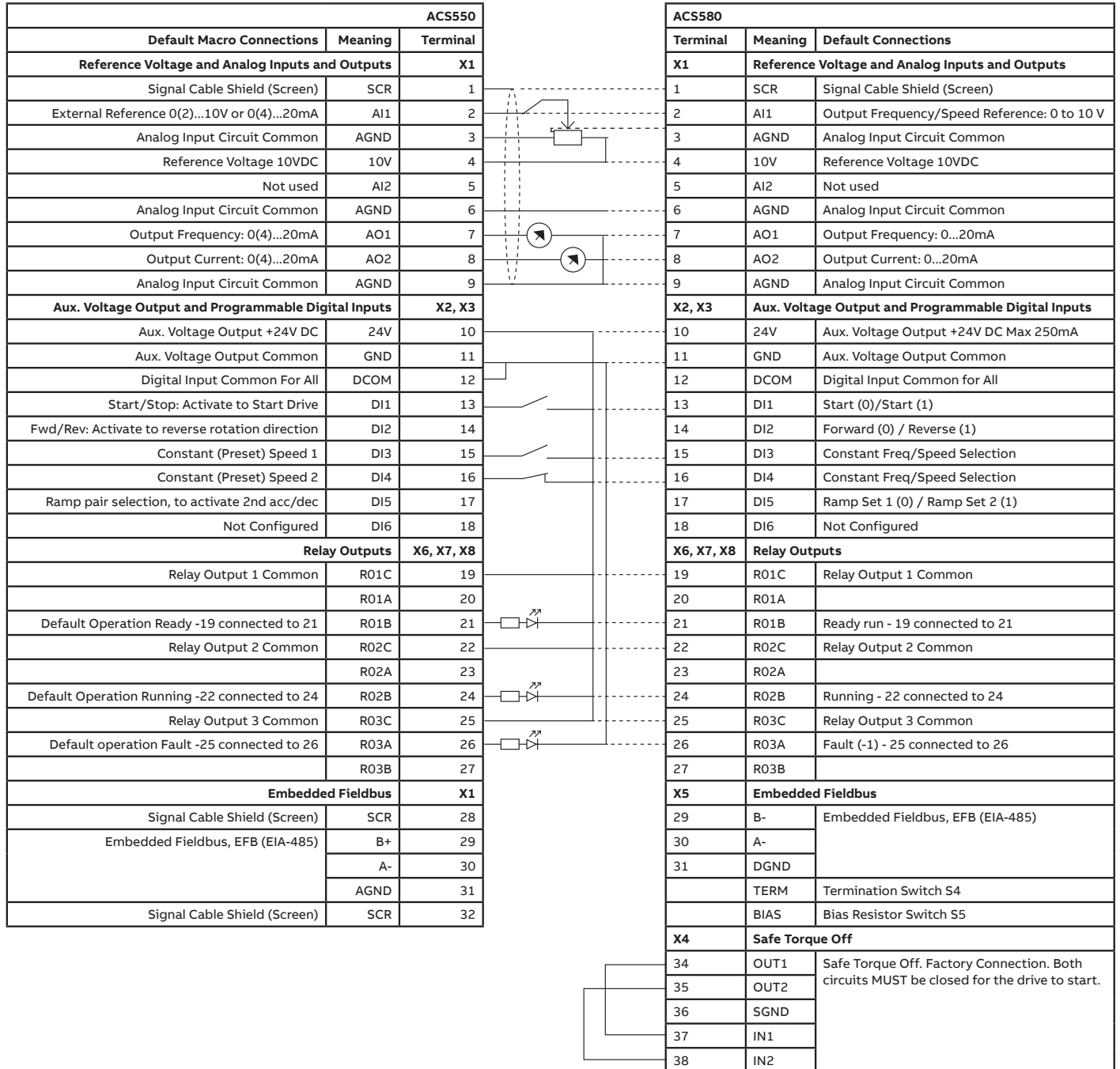

Total load capacitor of the Auxiliary voltage output +24V (X2:10) is 6.0 W (250 mA / 24 V DC).
 Digital inputs DI1...DI5 also support 10 to 24 V AC.

Parameter groups

Cross-reference

Parameters are listed in numerical order with first priority given to the ACS550 menu structure, and second priority given to the ACS580 menu structure.

A few parameters are classified in different groups, therefore this table is not exhaustive, but only a starting guide. Consult the Firmware Manual for a thorough list.

ACS550 Group	Description	ACS580 Group	Description
01	Operating Data	→ 01	Actual Values
03	FB Actual Signals	→ 03	Input References
04	Fault History	→ 04	Warnings and Faults
--	--	→ 05	Diagnostics
--	---	→ 11	Standard DIO/FI/ FO
10	Start/Stop/Direction	→ 20	Start/Stop/Direction
11	Reference Select	→ 22	Speed ref. sel.
		→ 28	Frequency chain
12	Constant Speeds	→ 22	Speed ref. sel.
		→ 28	Frequency chain
13	Analog inputs	→ 12	Standard AI
14	Relay Outputs	→ 10	Standard DI/RO
15	Analog Outputs	→ 13	Standard AO
16	System Controls	→ 96	System
20	Limits	→ 30	Limits
21	Start/Stop Mode	→ 21	Start/Stop Mode
22	Accel/Decel	→ 23	Speed ref. ramp
		→ 28	Frequency chain
23	Speed Control	→ 25	Speed Control
24	Torque Control	→ --	--
25	Critical Speeds	→ 22	Speed ref. sel.
		→ 28	Frequency chain
26	Motor Control	→ 97	Motor Control
29	Maintenance Trigger	→ --	--
30	Fault Functions	→ 31	Fault Functions

ACS550 Group	Description	ACS580 Group	Description
31	Automatic Reset	→ 31	Fault Functions
32	Supervision	→ 32	Supervision
33	Information	→ 7	System Info
34	Panel Display	→ --	--
35	Motor Temp Measurement	→ 35	Motor Thermal Protection
36	Timed Functions	→ 34	Timed Functions
37	User Load Curve	→ 37	User Load Curve
40	Process PID Set 1	→ 40	Process PID Set 1
41	Process PID Set 2	→ 41	Process PID Set 2
42	Ext/Trim PID	→ 71	External PID 1
45	Energy Saving	→ 45	Energy Efficiency
51	Ext. Comm Module	→ 50	Fieldbus Adapter (FBA)
52	Panel Comm	→ 51	FBA A Settings
		→ 52	FBA A Data In
		→ 53	FBA A Data Out
		→ 49	Panel Port Comms
53	EFB Protocol	→ 58	Embedded Fieldbus
64	Load Analyzer	→ 36	Load Analyzer
81	PFC Control	→ 76	PFC Configuration
		→ 77	PFC Maintenance
--	--	→ 95	HW Configurations
98	Options	→ 58	Embedded Fieldbus
99	Motor Data	→ 99	Motor Data
9904	Motor Control Mode	→ 99.04	Motor Control Mode



Notes

Additional information

We reserve the right to make technical changes or modify the contents of this document without prior notice. With regard to purchase orders, the agreed particulars shall prevail. ABB does not accept any responsibility whatsoever for potential errors or possible lack of information in this document.

We reserve all rights in this document and in the subject matter and illustrations contained therein. Any reproduction, disclosure to third parties or utilization of its contents – in whole or in parts – is forbidden without prior written consent of ABB.



—
For more information, please contact your local ABB representative or visit

solutions.abb/us-drives
abb.com/drives

ABB Inc.
16250 W. Glendale Drive
New Berlin, WI 53151
(800) 752-0696

ABB Inc.
800 Hymus Boulevard
Saint-Laurent, QC
H4S 0B5