

# DCS Thyristor Power Converters for DC Drive Systems 25 to 5200 A

## Service Manual DCS 500B DCS 600 MultiDrive

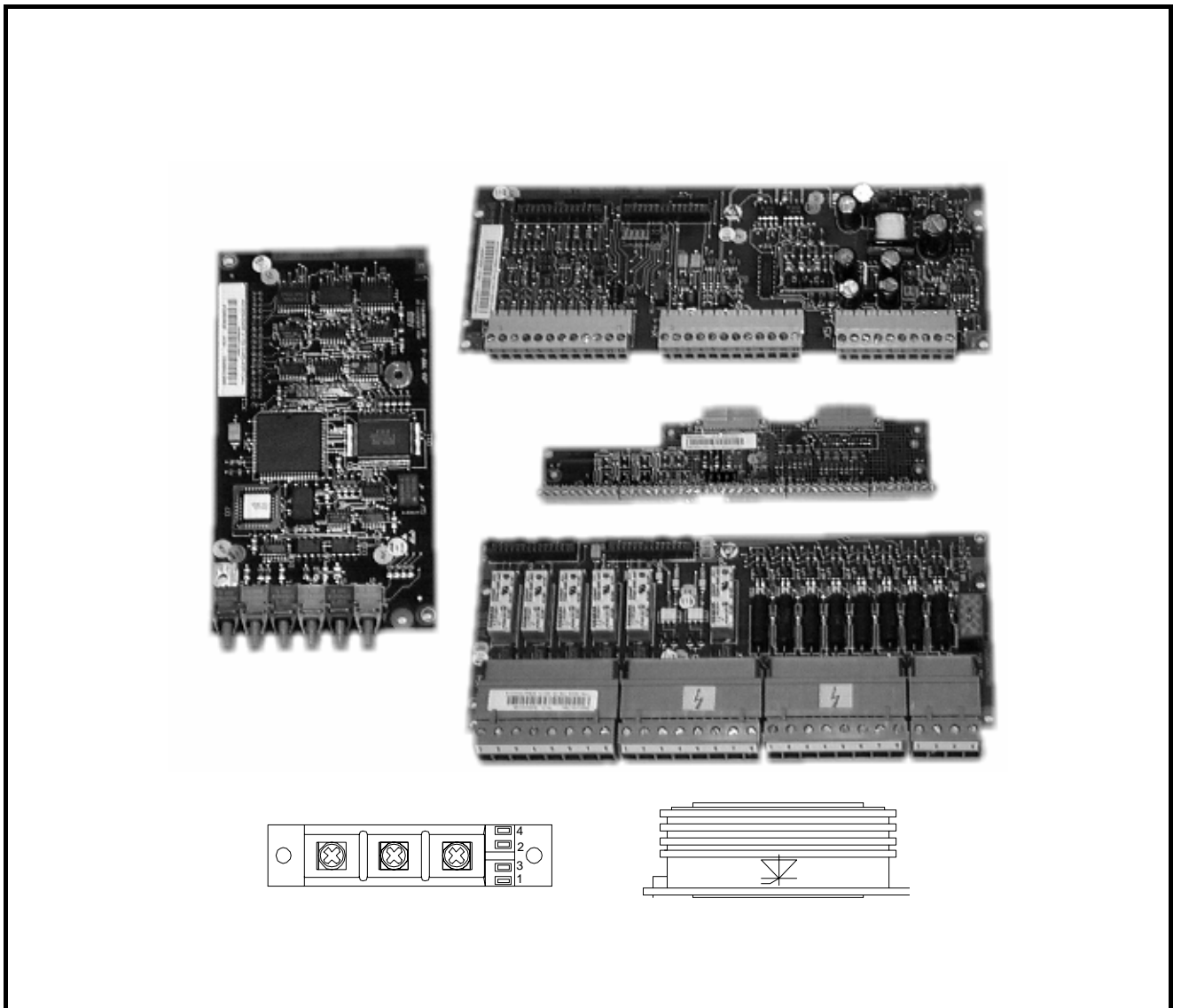

## How to use the DCS Documentation System

The matrix below indicates all available product documentation and its corresponding order numbers on its left columns as well as all existing DC Drive systems on its top rows. System descriptions, Technical data and Operating instructions (as far as they are available for the corresponding drive) are the basic documents and will be delivered together with each drive. All other documentation has to be ordered separately.

DC drive systems			System Drive				Standard Drive				Rebuild		
			Cabinet		Module		Cabinet		Module		DCR		
			DCA 600	DCA 620	DCS/DCF 600 MultiDrive	DCS 600 CraneDrive	DCA 500 / DCA 520	DCS 500 Easy Drive	DCS 400 Easy Drive	DCS 400	DCS/DCF 500B	DOE	DCR
<b>Product documentation</b>													
<b>System description</b>			Language		Volume								
3ADW000066			EN, DE, FR		II D								
3ADW000072			EN, DE		II F		x	x					
3ADW000121 ☉			EN		II F1		x	x					
3ADW000095 (Manual) ☉			EN, DE, FR, IT, SP		II K				x			x	
3ADW000139			EN		II F		x						
3ADW000071 (Flyer)			EN, DE					x					
3ADW000152			EN, DE, FR, IT, SP									x	
3ADW000173 (Flyer)			EN						x				
<b>Technical Data</b>			Language		Volume								
3ADW000165			EN		III						x		
<b>Operating Instructions</b>			Language		Volume								
3ADW000055			EN, DE, FR, SP		IV A			x	x		x		
3ADW000080			EN, DE		IV F		x	x					
3ADW000091 (Installation)			EN, DE		IV F1		x	x					
<b>Quick Guide</b>			Language		Volume								
3ADW000177 (DCS 500B)			EN, DE, FR, IT, SP		I			x	x		x		
3ADW000179 (DCS 600)			EN, DE, FR, IT, SP		I		x	x					
<b>Software description</b>			Language		Volume								
3ADW000078			EN		V D1			x	x		x		
3ADW000076			EN		V F		x	x					
3AST000953 ☉			EN				x						
<b>Tools</b>			Language		Volume								
3AFE61178775 CM1/DCS500			EN		-			x	x		x		
EN 5926915-1 GAD			EN		-			x	x		x		
3ADW000048 (Application blocks)			EN		V A2			x	x		x		
3AFY61296123 Drive Window			EN		-		x	x					
<b>Service Instructions</b>			Language		Volume								
3ADW000093			EN, DE		VI A		x	x			x		
3ADW000131			EN		VI K				x		x	x	
<b>Fieldbus</b>			Language		Volume								
3ADW000086			EN		-			x	x		x		
3ADW000097			EN		-		x	x					
<b>Others</b>			Language		Volume								
3ADW000115 12-Pulse operation			EN		VIII F2		x						
3ADW000092 Rebuild manual			EN		XI H1			x					
3ADW000128 Paralleling DCS Conv.			EN		VIII D1		x				x		
3ADW000040 12-Puls operation			EN, DE		VIII A2		x				x		

available only for: DCS 500B / 600 drive systems

Status: 14. June 2004

- ☉ Covers information of Technical data
- ☉ Covers information of Technical data, Operating Instructions, Software Description
- ☉ Covers information of Operating Instructions, Software Description

**Note:** For clearness the type designation in this brochure is shown in the following way:

Designation	is valid for
<b>DCS 500</b>	DCS 500 DCS 500B
<b>DCS 600</b>	DCS 600

**DCS Thyristor Power Converters**  
for DC Drive Systems  
25 to 5200 A

**Service Manual**  
**DCS 500B**  
**DCS 600 MultiDrive**

Code: 3ADW 000 093 R0801 Rev H

S\_M\_E\_G.DOC

EFFECTIVE: Oct. 27th, 2005  
SUPERSEDES: Rev G Jul. 9th, 2004



# Safety Instructions

---

## Attention

The manual *Safety and operating instructions for drive converters* (3ADW 000 033) has to be followed strictly.

## Overview

This chapter contains safety instructions which must be complied with during installation, operation and maintenance of the power converters series **DCS 500B or DCS 600**. If these instructions are not complied with, this may result in injuries (perhaps even with fatal) or in damage to the power converter, the motor and the driven machine. Before starting with any work whatsoever at or with this unit, you must read the information given in this chapter.

## Warnings

Warnings provide information on states which if the specified procedure for the state concerned is not meticulously complied with may result in a serious error, in major damage to the unit, in injury to persons and even in death.

They are identified by the following symbols:



**Danger: High Voltage!** This symbol warns you of high voltages which may result in injuries to persons and/or damage to equipment. Where appropriate, the text printed adjacent to this symbol describes how risks of this kind may be avoided.

- All electrical installation and maintenance work on the thyristor power converter must be carried out by properly qualified staff who have been thoroughly trained in electrical engineering.
- The thyristor power converter and its adjacent units must be properly earthed by qualified professionals.
- You must NEVER perform any work on the thyristor power converter while it is still switched on. First switch the unit off, use a measuring instrument to make absolutely sure that the power converter has really been de-energized, and only then you may start with the work concerned.
- Due to external control circuits, there may be dangerously high voltages present at the thyristor power converter even after the line voltage has been switched off. So always work at the unit with appropriate caution! Non-compliance with these instructions may result in injury (or even death!).



**General warning:** this symbol warns you of non-electrical risks and dangers which may result in serious or even fatal injury to persons and/or in damage to equipment. Where appropriate, the text printed adjacent to this symbol describes how risks of this kind may be avoided.

- When thyristor power converters are in use, the electric motors, power transmission elements and the driven machines are working in an extended operating range, which means they have to cope with a relatively high loading.
- You should have made sure that all units, devices and appliances used are actually suitable for this higher loading.
- If you have to operate the thyristor power converter at a rated motor voltage and/or a rated motor current significantly below the figures stated in the thyristor power converter's output data, you must take appropriate precautionary measures to protect the unit against overspeed, overload, breakage, etc., by modifying the software or hardware appropriately.
- For insulation testing, you must disconnect all cables from the thyristor power converter. You should avoid operating your unit at values other than the rated data. Non-compliance with these instructions may cause lasting damage to the thyristor power converter.
- The thyristor power converter possesses a number of automatic reset functions. When these functions are executed, the unit will be reset after an error and will then resume operation. These functions should not be used if other units and devices are not suitable for an operating mode of this kind, or if their use might entail dangerous situations.



**Warning of electrostatic discharge:** this symbol warns you against electrostatic discharges which may damage the unit. Where appropriate, the text printed next to this symbol describes how a risk of this kind may be avoided.

## Notes

Notes supply information on states requiring particular attention, or indicate that additional information is available on a specific topic. For this purpose, the following symbols are used:

**CAUTION!**      **Cautions** are designed to draw your attention to a particular state of affairs.

**Note**            A **note** contains or refers you to additional information available on the particular topic concerned.

## Mains connection

You can use a switch disconnecter (with fuses) in the power supply of the thyristor power converter to disconnect the electrical components of the unit from the power supply for installation and maintenance work. The type of disconnecter used must be a switch disconnecter as per EN 60947-3, Class B, so as to comply with EU regulations, or a circuit-breaker type which switches off the load circuit by means of an auxiliary contact causing the breaker's main contacts to open. The mains disconnecter must be locked in its "OPEN" position during any installation and maintenance work.

## EMERGENCY STOP buttons

EMERGENCY STOP buttons must be installed at each control desk and at all other control panels requiring an emergency stop function. Pressing the STOP button on the CDP 31x control panel of the thyristor power converter will neither cause an emergency motor stop, nor will the drive be disconnected from any dangerous potential.

To avoid unintentional operating states, or to shut the unit down in case of any imminent danger according to the standards in the safety instructions it is **not** sufficient to **merely** shut down the drive via signals „RUN“, „drive OFF“ or „Emergency Stop“ respectively „control panel“ or „PC tool“.

## Intended use

The operating instructions cannot take into consideration every possible case of configuration, operation or maintenance. Thus, they mainly give such advice only, which is required by qualified personnel for normal operation of the machines and devices in industrial installations.

If in special cases the electrical machines and devices are intended for use in non-industrial installations - which may require stricter safety regulations (e.g. protection against contact by children or similar) -, these additional safety measures for the installation must be provided by the customer during assembly.

*Safety Instructions*



# Contents

---

## VI A SERVICE MANUAL

### **Chapter 1 - Introduction**

How to use this manual.....	1-1
Contents of this manual .....	1-1
Target group .....	1-2
Associated publications .....	1-2
Storage and transport .....	1-2
Rating plate and type code .....	1-2

### **Chapter 2 - Fault Tracing Thyristors**

How to detect, if a thyristor is faulty .....	2-1
A fuse is blown .....	2-1
Ripple monitor .....	2-1
How to find a faulty thyristor.....	2-2
Converters size C1 and C2/C2b (25...1000 A).....	2-2
Blown fuses .....	2-2
Converters size A5, A6, A7, C3 and C4 (900...5200 A) .....	2-3
Blown fuses .....	2-3
Ripple monitor .....	2-3

### **Chapter 3 - Handling the Semiconductors**

General Instruction how to handle the Semiconductors .....	3-1
--	-----

### **Chapter 4 - Exchange of Thyristors for Sizes C1/C2/C2b**

Installation of thyristor modules in converters size C1/C2/C2b (25...1000 A).....	4-1
Required Tools .....	4-1
Remove faulty thyristor modules .....	4-1
Install new thyristor modules .....	4-2
Thyristor module location .....	4-3
Module terminals .....	4-8

### **Chapter 5 - Exchange of Thyristors for Size A5**

Installation of "Disc Type" thyristor in converters size A5 (900...2000 A) .....	5-1
Required Tools .....	5-1
Find faulty thyristor .....	5-2
Remove faulty thyristor.....	5-3
Install new thyristor.....	5-4

### **Chapter 6 - Exchange of Thyristors for Size A6**

Installation of "Disc Type" thyristor in converters size A6 (1900...3000 A) .....	6-1
Required Tools .....	6-1
BCT thyristors.....	6-2
Find faulty thyristor .....	6-3
Remove faulty thyristor.....	6-4
Install new thyristor.....	6-7

### **Chapter 7 - Exchange of Thyristors for Size A7**

Installation of "Disc Type" thyristor in converters size A7 (2050...5200 A) .....	7-1
Required Tools .....	7-1
Find faulty thyristor .....	7-2
Install new thyristor .....	7-5
<b>Chapter 8 - Exchange of Thyristors for Size C3</b>	
Installation of "Disc Type" thyristor in converters size C3 (900...2000 A) .....	8-1
Required Tools .....	8-1
Remove faulty thyristor .....	8-2
Find faulty thyristor .....	8-2
Install new thyristor .....	8-3
Fasten the clamp .....	8-3
<b>Chapter 9 - Exchange of Thyristors for Size C4</b>	
Installation of "Disc Type" thyristor in converters size C4 (2050...5150 A) .....	9-1
Required Tools .....	9-1
Find faulty thyristor .....	9-2
Install new thyristor .....	9-3
<b>Chapter 10 - Service</b>	
Compatibility of SDCS-PIN-2 boards .....	10-3
Description of SDCS-PIN-20xB boards .....	10-3
Hardware coding .....	10-3
Snubber circuit .....	10-3
Compatibility of SDCS-PIN-20x boards .....	10-3
Compatibility of SDCS-PIN-20x and SDCS-PIN-2x boards .....	10-3
Change SDCS-PIN-2x boards .....	10-3
Compatibility of thyristor modules for DCSxxx-0200 and DCSxxx-0250 .....	10-3
Types concerned: .....	10-3
Actual status .....	10-3
Hardware: .....	10-3
Subject: .....	10-3
Time schedule: .....	10-3
Compatibility: .....	10-3
DC-Motor neutral zone adjustment .....	10-3
Types concerned .....	10-3
Summary .....	10-3
General .....	10-3
How to remove the converter fan in a frame A6 .....	10-3
How to remove the converter fan in a frame A7 .....	10-3
SDCS-CON-x Firmware download instructions for Windows 2000 and NT 4.0 .....	10-3
Hardware Configuration .....	10-3
Firmware download Kit .....	10-3
NPCU-02 .....	10-3
Bus cable .....	10-3
Installation .....	10-3
Software Configuration .....	10-3
PC Operating Systems .....	10-3
Drive Software Versions .....	10-3

Programs / Files .....	10-3
Firmware download with Windows 2000 .....	10-3
Recommendation .....	10-3
Preparation.....	10-3
HyperTerminal Private Edition .....	10-3
Flash Erase .....	10-3
Flash Program.....	10-3
Firmware download with Windows NT 4.0 .....	10-3
Recommendation .....	10-3
Preparation.....	10-3
HyperTerminal.....	10-3
Flash Erase .....	10-3
Flash Program.....	10-3
DCS600 MultiDrive - How to download firmware on a SDCS-AMC-DC 2 board under Windows 2000 .....	10-3
Types concerned.....	10-3
Summary .....	10-3
Download DCS600 MultiDrive firmware .....	10-3
DCS600 MultiDrive - How to download firmware on a SDCS-AMC-DC 2 board under Windows NT 4.0 .....	10-3
Types concerned.....	10-3
Summary .....	10-3
Download firmware with PCMCIA card (notebook or desktop) .....	10-3
Installation of NtNisa drivers .....	10-3
Configure PC.....	10-3
Download DCS600 MultiDrive firmware .....	10-3
DCS600 MultiDrive - How to download parameter files on a SDCS-AMC-DC x board .....	10-3
Types concerned.....	10-3
Summary .....	10-3
<b>Reload DCS600 MultiDrive parameters</b> .....	10-3
 <b>Chapter 11 - Preventive Maintenance</b>	
Recommended regular maintenance .....	11-3
Air Filters .....	11-3
Cooling air pressure switch in converter modules type A6/A7/C4.....	11-3
Fan .....	11-3
Heatsink .....	11-3
Internal high current connections in converters type A7/C4.....	11-3
Relays and electrical connections .....	11-3
 <b>Appendix A - Spare Parts List</b>	

*Contents*

# Chapter 1 - Introduction

---

## **How to use this manual**

The purpose of this service manual is to provide detailed information on how to service power converters from the **DCS 500B** or **DCS 600** series.

**Note:** If it is not mentioned explicitly all details given in this Service Manual will be valid for both, series **DCS 500B** and series **DCS 600**!

## **Contents of this manual**

### **Chapter 1 - Introduction**

This chapter informs about the contents and the use of this manual as well as the boundary conditions applying and the thyristor power converter rating plate.

### **Chapter 2 - Fault Tracing Thyristors**

This chapter describes how to detect and select a faulty thyristor.

### **Chapter 3 - Handling the Semiconductors**

This chapter describes the handling of thyristors and thyristor modules.

### **Chapter 4 - Exchange of Thyristors of Sizes C1/C2/C2b**

This chapter describes the exchange of thyristors in converters sizes C1/C2.

### **Chapter 5 - Exchange of Thyristors of Size A5**

This chapter describes the exchange of thyristors in converters size A5.

### **Chapter 6 - Exchange of Thyristors of Size A6**

This chapter describes the exchange of thyristors in converters size A6.

### **Chapter 7 - Exchange of Thyristors of Size A7**

This chapter describes the exchange of thyristors in converters size A7.

### **Chapter 8 - Exchange of Thyristors of Size C3**

This chapter describes the exchange of thyristors in converters size C3.

### **Chapter 9 - Exchange of Thyristors of Size C4**

This chapter describes the exchange of thyristors in converters size C4.

### **Chapter 10 - Service**

This chapter contains hardware information and technical hints.

### **Chapter 11 - Preventive Maintenance**

This chapter describes the measures for preventive maintenance of the thyristor converters.

### **Appendix A - Spare Parts list**

The *Appendix A* contains the spare parts list of the converters.

**Target group**

This manual is designed to help those responsible for planning, installing, starting up and servicing the thyristor power converter.

These people should possess

- basic knowledge of physics and electrical engineering, electrical wiring principles, components and symbols used in electrical engineering, and
- basic experience with DC drives and products.

**Associated publications**

The **DCS 500B or DCS 600** documentation includes the following:

*Technical Data DCS Thyristor Power Converter*

*Operating Instructions*

*System Description DCS 500B*

*System Description DCS 600 MultiDrive*

---

**CAUTION!** The thyristor power converter weighs quite a lot and should therefore not be held by the front cover. Please put the unit down only on its back (sizes C1 to C3). Always use due care when handling the unit, so as to avoid injuries or damage.

---

**Storage and transport**

If the unit had been in storage prior to installation or is transported to another location, care must be taken to ensure that the environmental conditions are complied with (see "System Descriptions").

**Rating plate and type code**

For purposes of identification, each thyristor power converter is fitted with rating plates, stating the type code and the serial number, which serve for each unit's individual identification.

The type code contains information on the characteristics and the configuration of the unit.

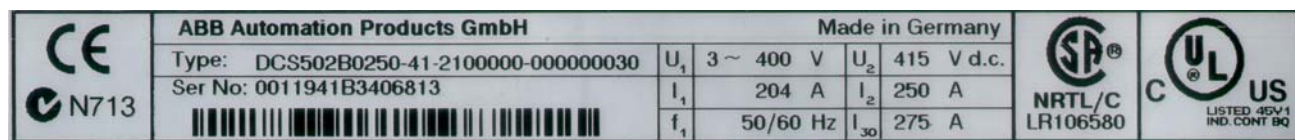

Figure 1-1 Example of a rating plate

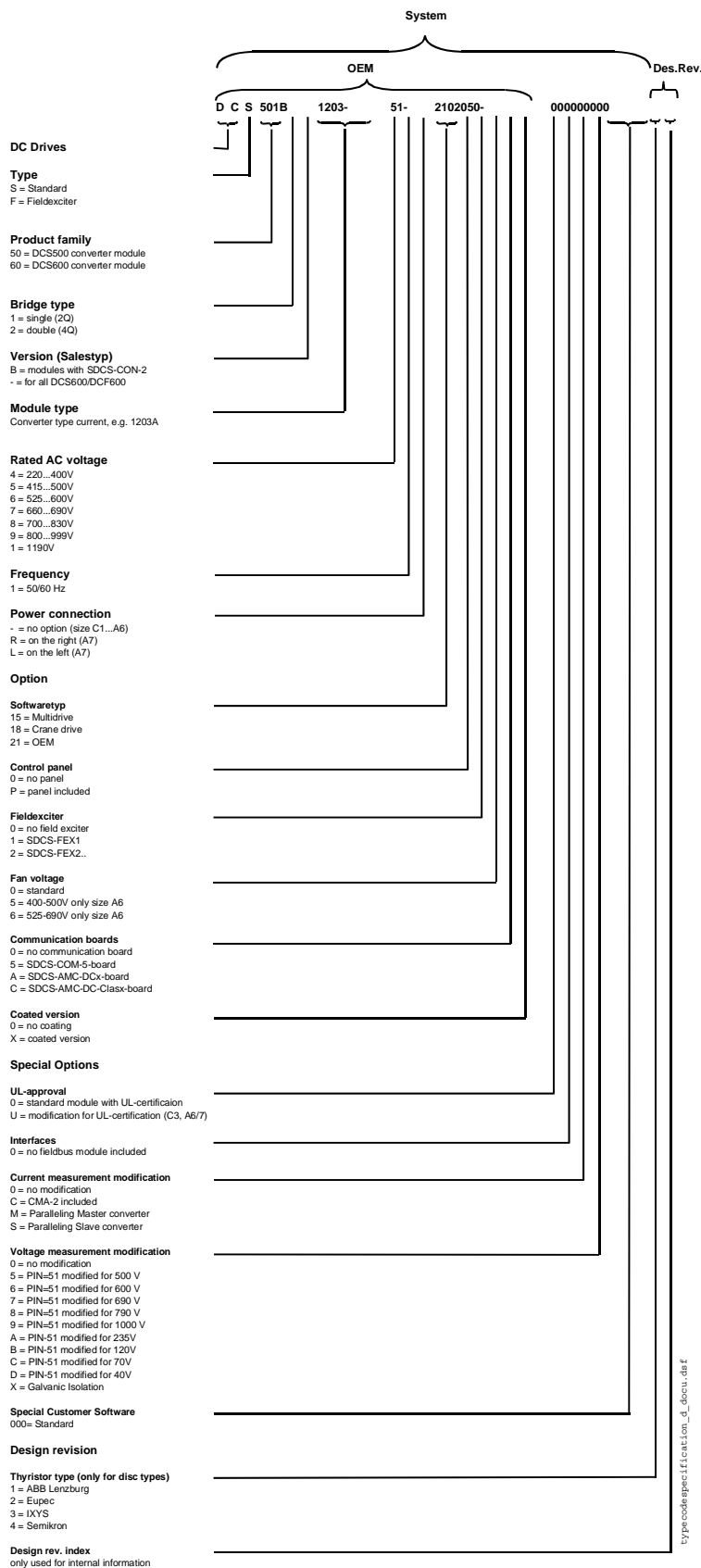

Figure 1-2 Type code

## *Chapter 1 - Introduction*

The technical data and specifications are valid as of going to press. ABB reserves the right to make subsequent alterations.

If you have any questions concerning your drive system, please contact your local ABB agent.



## Chapter 2 - Fault Tracing Thyristors

---

### **How to detect, if a thyristor is faulty**

Thyristor problems can be noticed by two ways:

#### **A fuse is blown**

This is an indication, that a strong overcurrent has happened due to one of the following reasons:

- An internal short circuit between the phases (line side) because of a defect thyristor (short circuit inside a thyristor from anode to cathode).
- An internal short circuit between the phases (line side) because of circulating current in a 4-Q converter (malfunction of the control electronics, no thyristor defect).
- An external short circuit at the DC terminals of the converter without sufficient impedance.
- A commutation fault during inverting mode operation (active braking with high current, high EMF and with low AC voltage).

**Note** In case of parallel fuses: If one of the parallel fuses is blown, all parallel fuses have to be changed. The 'undamaged' fuses might be 'half-blown' and will blow with the next high current.

#### **Ripple monitor**

The ripple monitor indicates, that the ripple of the DC current is much higher than normal. In such a case, most often one thyristor does not work. It's missing current contribution causes a deep dip in the direct current.

The structure of the current loop, the current controller will force the other thyristors to compensate the dip by a certain overcurrent in order to keep the average current constant. Such a compensation results in a ripple monitoring fault during motoring mode operation with  $\alpha \leq 90^\circ$ .

During braking or inverting mode operation most often fuses are blown.

The reason for a currentless thyristor may be:

- A fuse has disconnected one of the six thyristors. This is possible only for converters with 900...5200 A (six internal branch fuses). A converter with three external fuses stops working completely at once when one of the three AC input fuses interrupts a phase input of the converter.
- A thyristor does not get firing pulses.
- The current controller may be totally mismatched to the DC load.
- The AC mains network is causing that fault message. In this case, asymmetrical phase shift, uneven phase voltage or critical designed power factor correction equipment or harmonic reduction equipment can be the reason.

### **How to find a faulty thyristor**

If a blown fuse is suspected in the converter, the problem is caused most often by a faulty thyristor. To make sure, that a thyristor is the reason and needs to be exchanged fault tracing must be done in two different ways, depending on the size of the converter.



**In general, make sure, that all safety instructions, given within this manual or within the safety instructions, related to the machine or the application itself, are obeyed.**

#### **Converters size C1 and C2/C2b (25...1000 A)**

These converters require semiconductor fuses in the 3 AC lines.

- The converter must be disconnected from the mains.
- One motor armature cable should be disconnected from the converter.

#### **Blown fuses**

- Using the OHM function of a normal multimeter, measurements must be made from each AC terminal to each DC terminal (U1 to C1, V1 to C1, W1 to C1, U1 to D1, V1 to D1 and W1 to D1; see [Figure 4-3](#)). Normally, every measurement should show high resistance ( $> 1 \text{ k}\Omega$ ). Target: find a short circuit, indicated by low resistance ( $< 1 \Omega$ ) (destroyed thyristor).
- If the converter is designed with half-bridge thyristor modules, then a module consists of two antiparallel thyristors. In this case it is sufficient to know which thyristor pair or module has a defective thyristor because the complete module must be replaced.
- After a thyristor module is replaced, the above mentioned measurement should be done another time to make sure that all faulty thyristors have been detected!

#### **Note**

The RC circuit could also cause  $0 \Omega$  result for a short time.

The measurement, showing less resistance than  $1 \Omega$  should be made a second time with test leads applied to the terminals with the opposite polarity; if this measurement shows the same result, one or two thyristors located in that path are faulty; they need to be replaced.

**Converters size A5, A6, A7, C3 and C4 (900...5200 A)**

These converters are equipped with fuses in the branches of the power part.

- The converter must be disconnected from the mains.

**Blown fuses**

- In case of a blown fuse, the faulty thyristor or the faulty pair of thyristors are already isolated at one side from the others and therefor the faulty branch is known (see [Figure 5-1](#)).
- The OHM test should be performed, when the thyristor is still clamped. Outside the converter a special thyristor clamping device is needed.
- For 4-Q converters with antiparallel thyristors or BCT's: The selection of a forward or reverse thyristor or BCT (Bidirectional-Controlled-Thyristor) is done during the disassembly. Continue with related chapter [5](#), [6](#), [7](#), [8](#), or [9 Find faulty thyristor](#)
- After a thyristor was replaced, the OHM test should be done another time to make sure that all faulty thyristors have been detected! If the motor is still connected to the converter the result of the measurement may be wrong.

**Ripple monitor**

If the ripple monitor fault occurred, the fault tracing must be adapted to the reasons listed before:

- Check the fuses and the thyristors, according to the statements before.
- If the power section seems to be ok, but still one or more thyristors don't take current, something went wrong in between the firing pulse generation and the thyristor's gate; in this case check:
  - Is a firing pulse present on the primary side of the firing pulse transformer?
  - Is a firing pulse present on the secondary side of the firing pulse transformer?
  - Is the firing pulse transferred to the gate of the thyristor? Are there all electrical connections still healthy?
  - Can the thyristor be fired with the applied firing pulse? Is the pulse form of the firing pulse identical at all measuring positions?
- Check the settings of the current controller.
- Check the AC mains network by taking recordings of the line voltage and current at all 3 phases at the same time.



## Chapter 3 - Handling the Semiconductors

---

### **General Instruction how to handle the Semiconductors**

Thyristor modules, busbars and fuses have to be mounted with the correct torque using a torque screw driver or torque wrench.

Disc type thyristors in converters size C3 (900...2000 A DC) are normally mounted using a dial gauge, for repair reasons, they can be mounted using a torque wrench.

In converters sizes A5 (900...2000 A DC), A6 (1900...3000 A DC), A7 (2050...5200 A DC) and C4 (2050...5150 A DC) the mounting force is indicated by an indicating spring welded to the mounting clamp, which is inside the unit.

Always mark suspected damaged components clearly after removing them from the circuit, to avoid confusion with "good" components.

When removing a damaged semiconductor, write down how and where it was installed (direction, location, connected gate leads and with BCT's the position of the gate connectors).

Check that the new and old component have the same type designation or that the new component can replace the old one. A semiconductor can be replaced by different compatible semiconductor according to the codes in the manufacturers' table.

Semiconductor components are high-precision products. All unnecessary used tools and objects might damage the easily dented and scratched surfaces of the semiconductors.

1. Keep new semiconductors as long as possible in their original packages.
2. Use protective gloves if possible.
3. Clean work area and hands frequently.
4. Use good illumination.



# Chapter 4 - Exchange of Thyristors for Sizes C1/C2/C2b

---

## **Installation of thyristor modules in converters size C1/C2/C2b (25...1000 A)**

All DCS 500B and DCS 600 size C1/C2/C2b are equipped with thyristor **modules**.

In order to keep the operating temperature of the semiconductor module low, the joint between the heat sink and the module should have a good heat conducting ability. The electrical conductivity of the connectors must also be good. For this reason the following instructions must be observed with particular care.

### **Required Tools**

Special tools or material needed in addition to standard tools for the exchange of thyristor modules:

- torque spanner: mounting torques for thyristor module to heat sink and electrical connections see table "Nominal mounting torques for thyristor modules" in this chapter;
- screws are metric type; use appropriate nuts
- tissue paper / solvent
- thermal joint compound: type **BERULUB FZ1 E3**  
(grease)

Manufacturer: Carl Bechem GmbH, 58089 Hagen  
ABB Service: GHSN 390 011 P 0051

or

- thermal joint compound: type **WLPF 20** (10 ml)  
ABB Service: GHSN 390 011 P 10



**Before the work is started, disconnect the converter from the power supply completely, then check the voltage free condition and make sure, everything is located in an electrical and mechanical safe condition!**

### **Remove faulty thyristor modules**

- Tilt out the electronics casing.
- Remove the gate leads from the faulty thyristor module and mark the position of the trigger connections on the cable.
- Remove only as many parts as is needed around the faulty module. If the current transformer must be removed, mark the position and the connections!
- Remove the faulty thyristor module and mark it.

**Install new thyristor modules**

- Remove old thermal joint compound (grease) from the heat sink. Preparation of the heat sink: if the area is clean, spread out the heat-conducting compound with a rubber spatula or by hand. If the area is dirty, clean the heat sink surface with tissue paper. Clean the mounting surfaces with an appropriate solvent (e.g. ethanol).
- Apply a thin coat of thermal joint compound to the new module. Spread the thermal joint compound evenly by moving the module forward and backward on the heat sink.
- Tighten the clamping screws by hand until the screw heads touch the bottom of the module. Then tighten the screws to 2.5 Nm torque. If the module is mounted using four screws, tighten the screws crosswise.
- Tighten the screws to nominal torque (see Table below).
- Reinstall the busbars; make sure, the correct torque is applied and reconnect all cables.

Thyristor module		Nominal mounting torques	
Size (width)	Type	Electrical connections	Module to heat sink
20 mm block	SKKT.....	3 Nm	5 Nm
20 mm block	MCC 95-16io1B	3 Nm	3 Nm
34 mm block	SKKT.....	5 Nm	5 Nm
34 mm block	TT.....	6 Nm	6 Nm
50 mm block	SKKT.....	9 Nm	5 Nm
50 mm block	TT.....	12 Nm	6 Nm
50 mm block (single thyrist.)	SKET.....	9 Nm	5 Nm
50 mm block (single thyrist.)	TZ.....	12 Nm	6 Nm
60 mm block	TT425/TT570	12 Nm	6 Nm

*Table 4-1 Nominal mounting torques for thyristor modules*



**Thyristor module location**

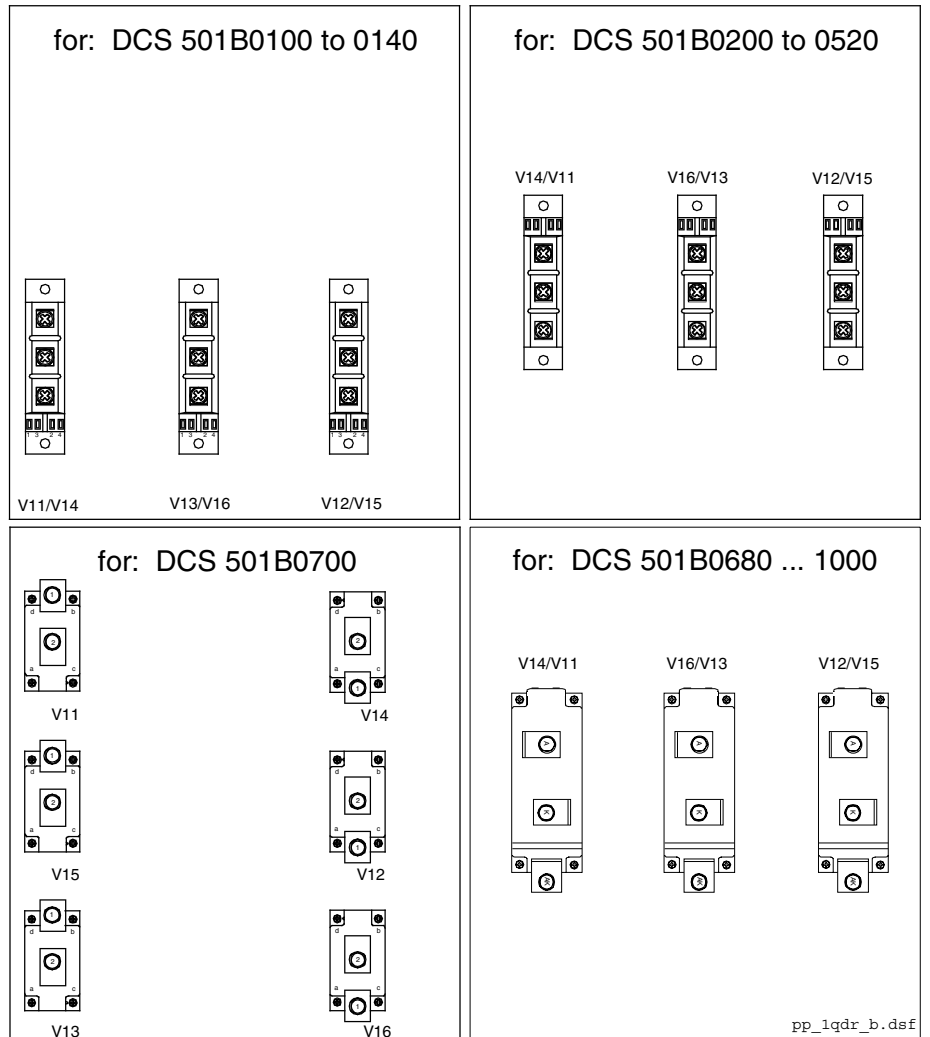

Figure 4-1 Location of thyristor modules in DCS 501B/601-0100...1000 units

**Note:** This drawing is only for showing the location of the modules, the module size can be different!

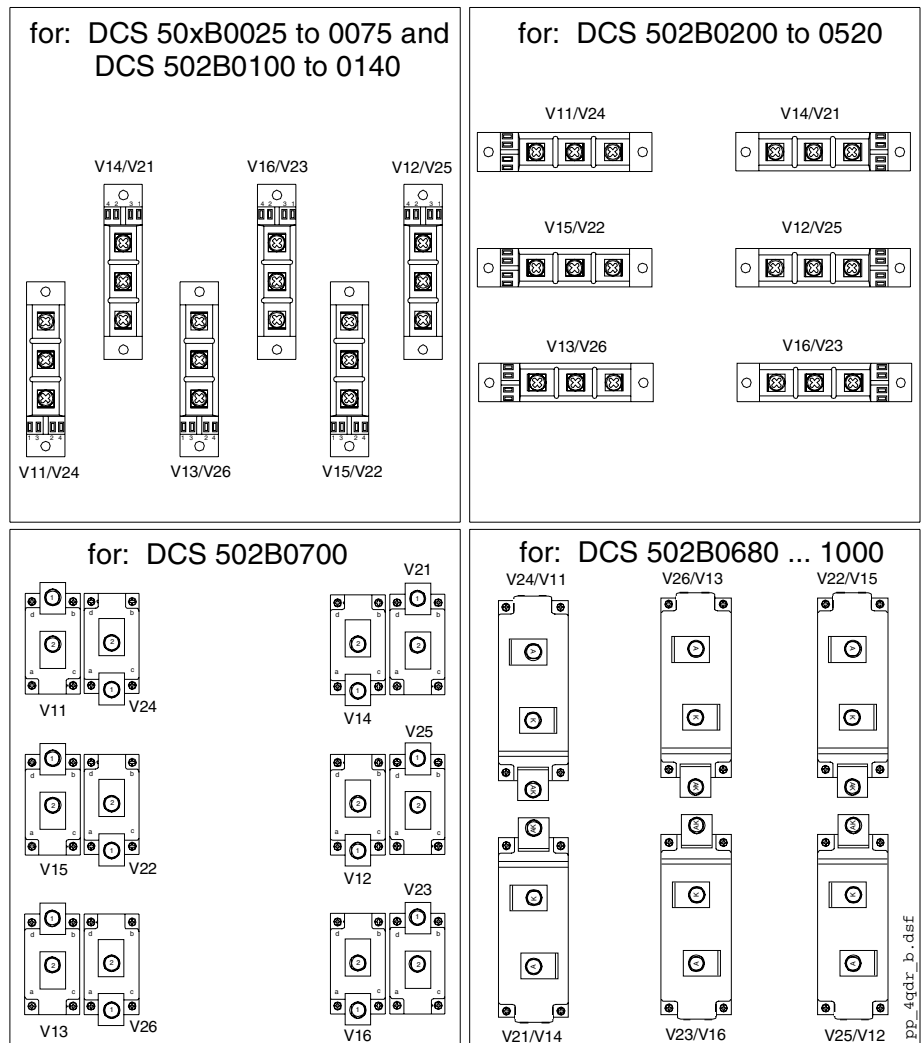
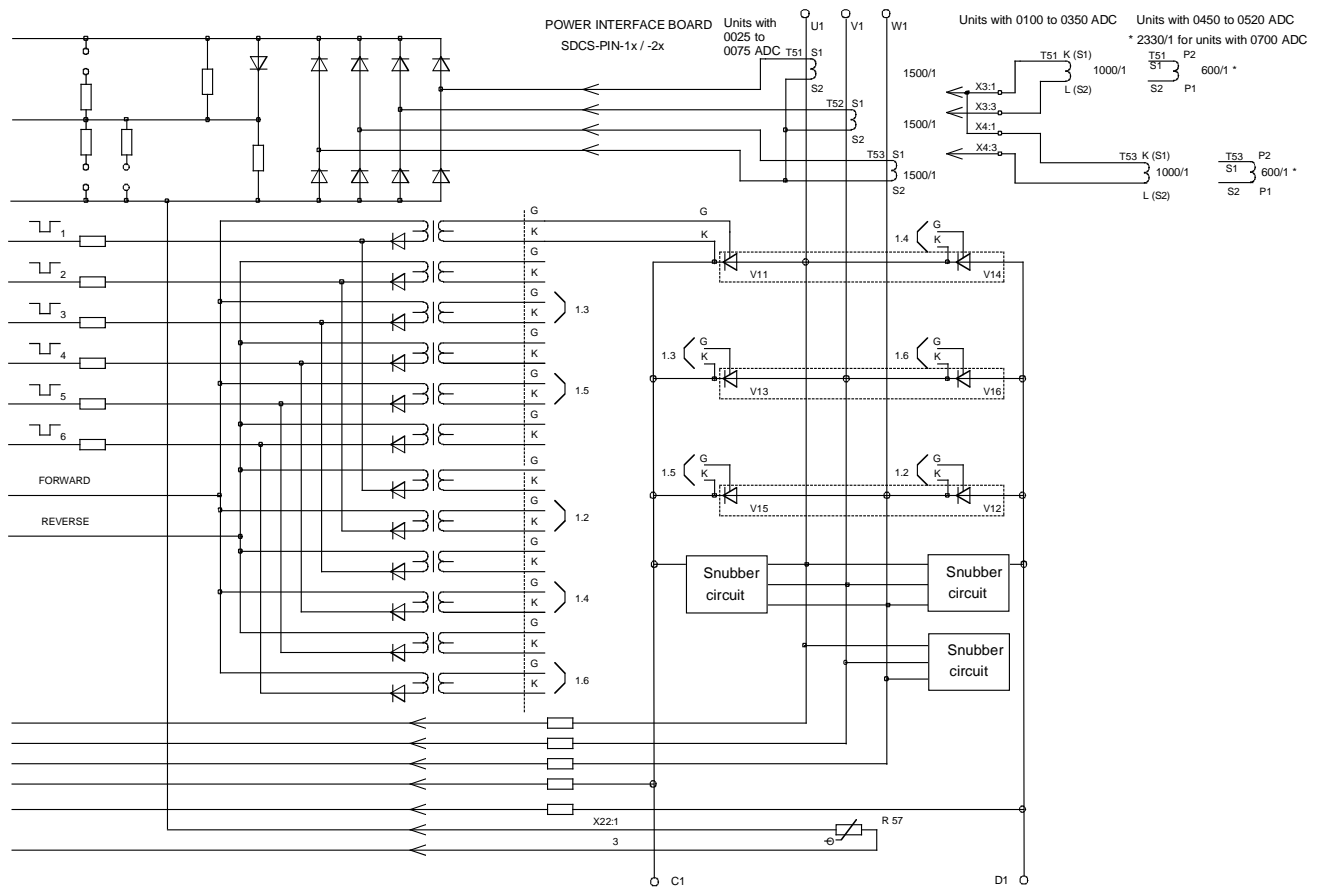

Figure 4-2 Location of thyristor modules in  
 DCS 50xB/60x-0025...0075 units  
 DCS 502B/602-0100...0700 units  
 DCS 502B/602-0680...1000 units

**Note:** This drawing is only for showing the location of the modules, the module size can be different!



Basic drawing / not all elements are shown

Figure 4-3 Basic drawing of DCS 501B/601 units with SDCS-PIN-1x/-2x

Chapter 4 - Exchange of Thyristors for Sizes C1/C2/C2b

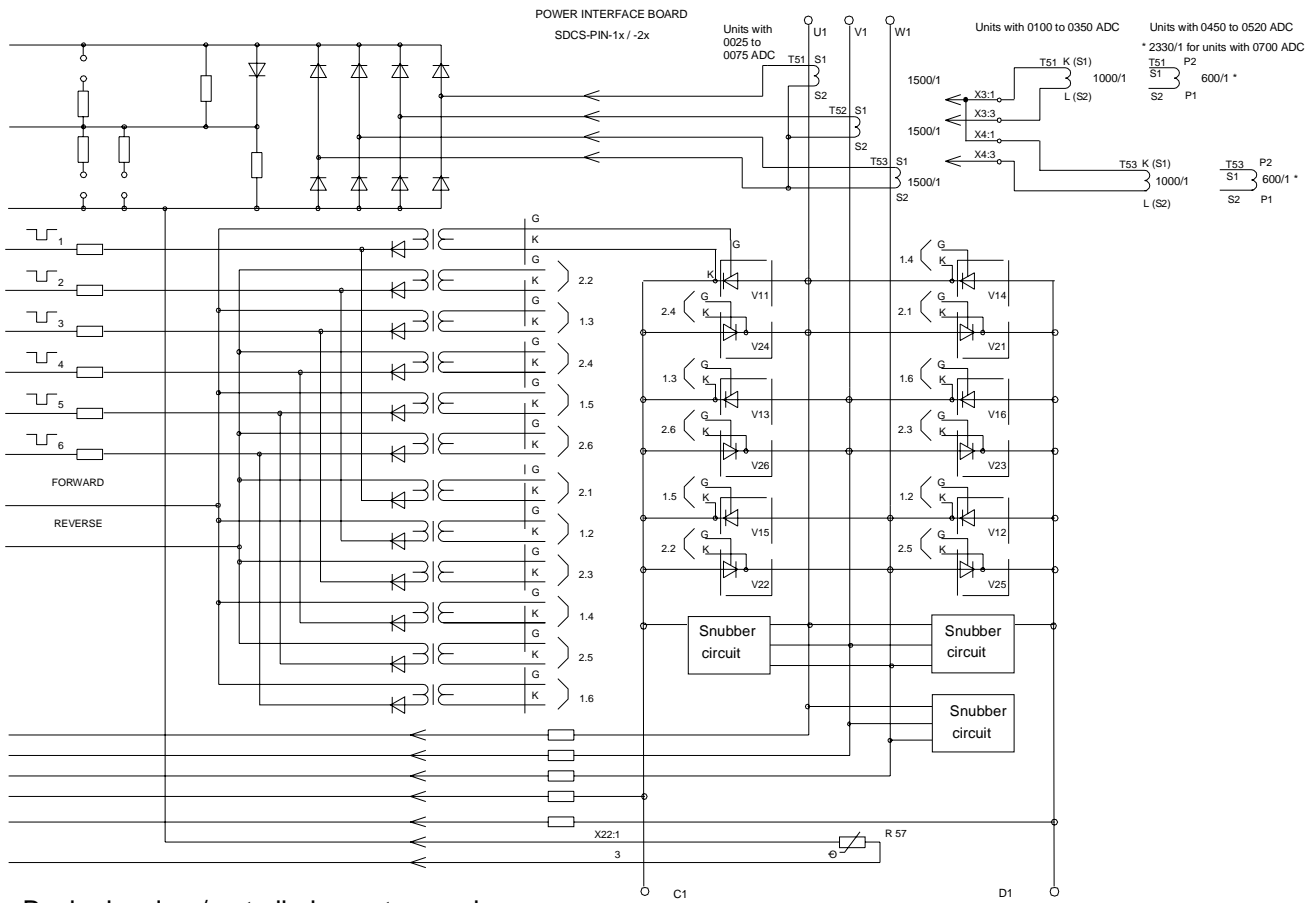

Basic drawing / not all elements are shown

Figure 4-4 Basic drawing of DCS 502B/602 units with SDCS-PIN-1x/-2x

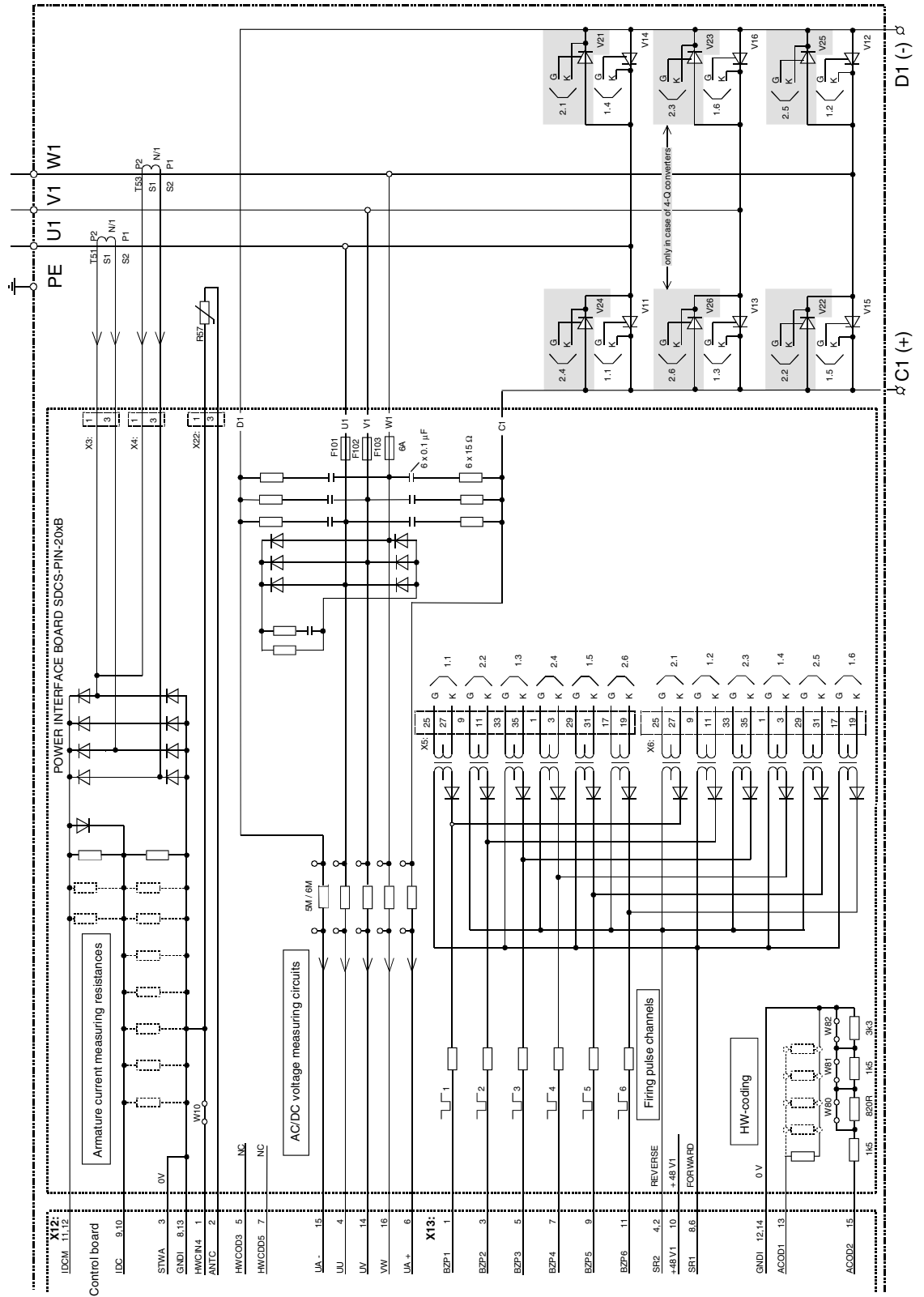

Figure 4-5 Typical armature circuit of DCS 50xB/60x with SDCS-PIN-20xB

**Module terminals**

The next figures show a few examples and terminals of thyristor modules. The terminals of modules are also stamped or marked by a sticker.

For all firing pulse cables is valid:

- Yellow** is gate lead.
- Red** is cathode lead.

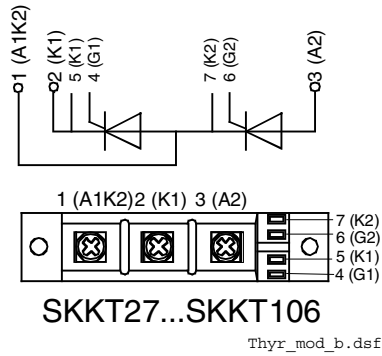

**Note:** This drawing is **not** valid for the types SKKT....B...

Figure 4-6 Terminals of half-bridge thyristor modules

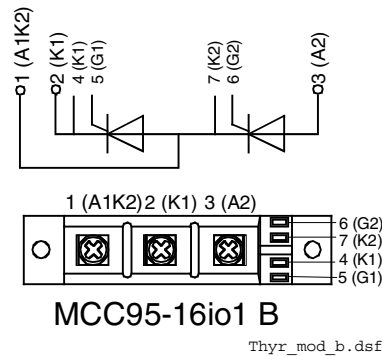

Figure 4-7 Terminals of half-bridge thyristor modules

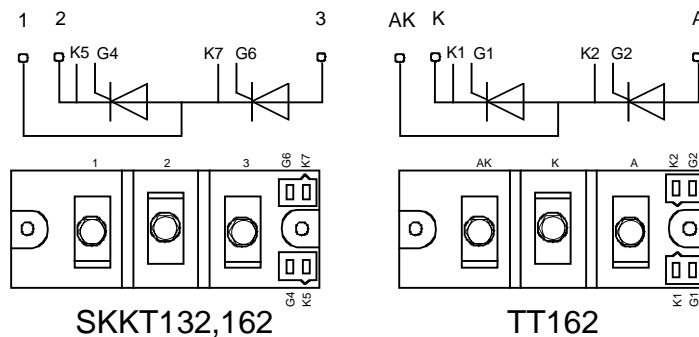

Figure 4-8 Terminals of half-bridge thyristor modules

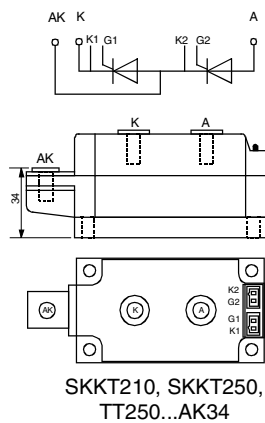

Figure 4-9 Terminals of half-bridge thyristor modules

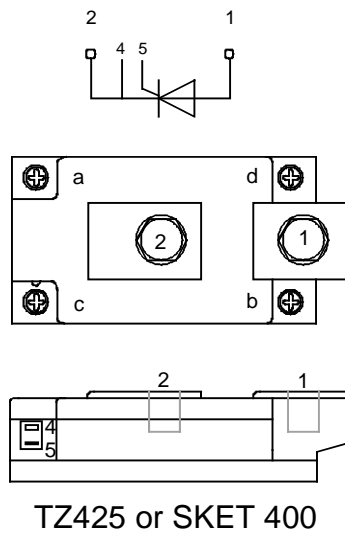

Figure 4-10 Terminals of single thyristor modules

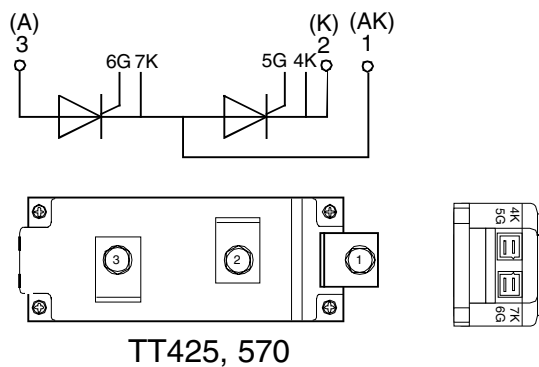

Figure 4-11 Terminals of half bridge thyristor modules







**Find faulty thyristor**

1. Find the defective branches by performing an OHM test (both polarities) between U1, V1, W1 and C1, D1 (see figure 5-1)

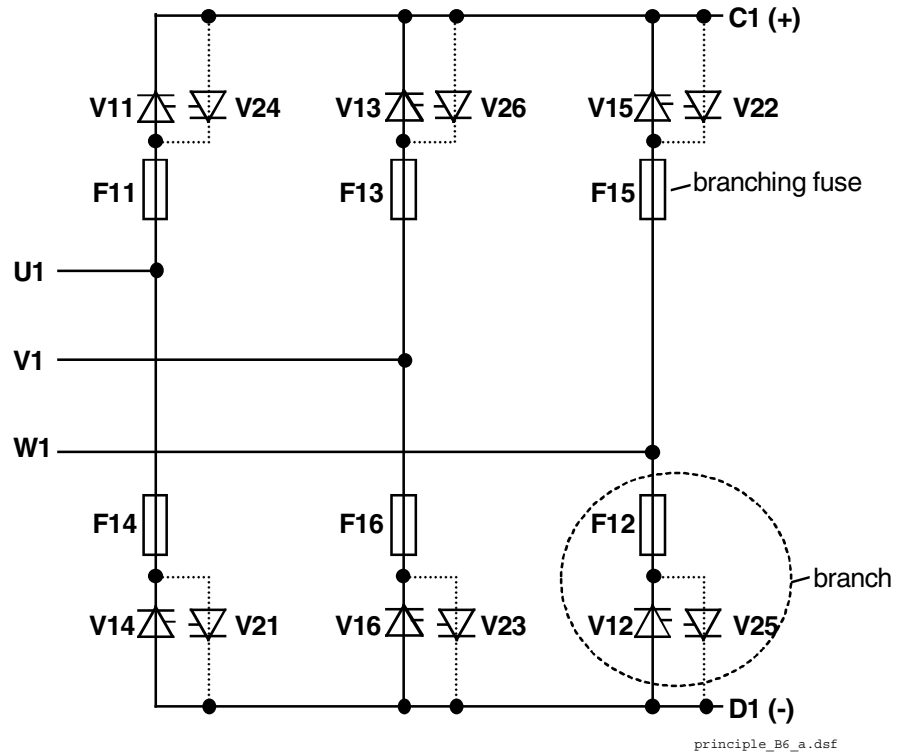

Figure 5-1 Anti-parallel B6-bridges with branching fuses

2. Disconnect the branch fuses of the defective branches.
3. Find the defective thyristors by performing an OHM test (both polarities) over their heat sinks.
4. In a 4-quadrant converter change both thyristors clamped between the same heatsinks at once.

**Note:** Because “Disc Type” semiconductors need a certain compression force to operate properly a measurement outside the clamped heat sinks might be wrong. To be sure change only one thyristor, clamp the heat sinks again and repeat step three.

**Remove faulty thyristor**

1. Remove the screws of the DC – busbars and branch fuses preventing the stack to be prized open.  
**Note:** It depends on the location of the defective thyristor which DC – busbar and fuses have to be disconnected.
2. Write down the direction and location of the thyristors to be removed and mark their gate leads.
3. Remove the gate leads if possible.
4. Loosen the mounting clamp ([see figure 5-3](#)) at the top of the thyristor stack.

**Attention:** While loosen the mounting clamp the indicating spring must be pulled out a little, otherwise the spring will be damaged!

5. Attach the disassembly tool at the faulty thyristor and prize open the upper and lower heat sinks (see [figure 5-2](#)).
6. Remove the thyristors.

**Attention:** To centre the thyristors spring pins are used. The pins are inlaid into all lower heat sinks. Open the gap wide enough that the thyristor and the pins are not damaged while removing the thyristor!

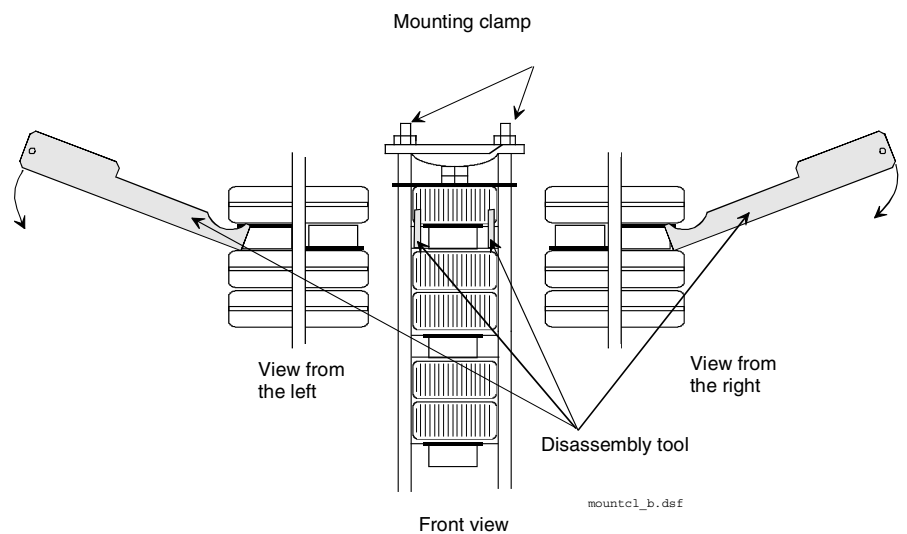

Figure 5-2 How to use the disassembly tool

**Install new thyristor**

1. Ensure that the new thyristor is of the correct type ([see Appendix A](#)). Keep the semiconductor and its surroundings clean. If necessary clean them with a piece of tissue paper moistened with solvent.  
**Note:** Do not touch the polished surfaces of the thyristor.
2. Clean the polished surfaces of the semiconductor with a piece of tissue paper moistened with solvent. Dry all surfaces. Spread a **thin** layer of heat conducting paste on both sides of the thyristor, if necessary use a rubber spatula.
3. Connect the gate leads if possible.
4. Clean all parts with tissue paper moistened with solvent, which have had or will have contact with the thyristor or each other (lower / upper heat sink). Do not clean the surfaces of grease too thoroughly, because the aluminium surfaces will oxidise in a few seconds. Dry all surfaces.
5. Centre the thyristors by means of the spring pins.  
**Note:** Be sure that the thyristor is installed in the right direction. Do not pinch or cut the gate leads or any other cable.
6. Turn the thyristor so that the gate leads point in the right direction.

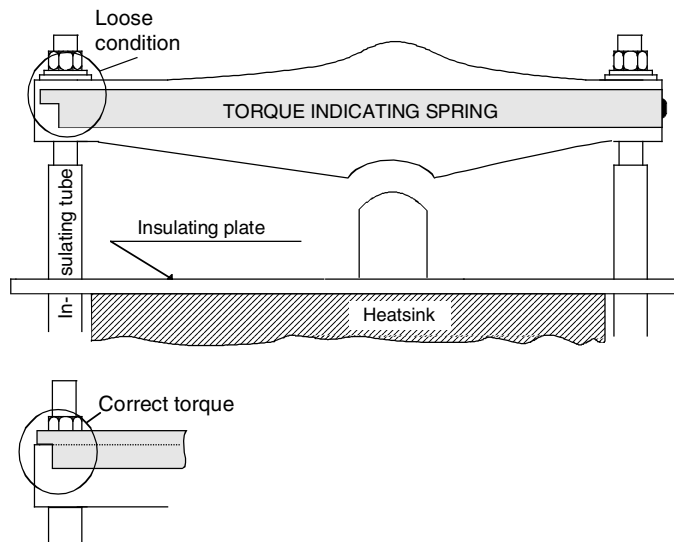

Figure 5-3 Aluminium spring with welded indicating spring

7. Tighten the nuts of the mounting clamp by hand so that the clamp is in parallel with the contact surface of the heat sinks.  
**Note:** The indicating spring is a very sensitive instrument and must be handled with care.
8. Tighten each nut in turn, half a turn at a time with the help of a ring spanner until the indicating spring clicks into position “correct torque” (see [figure 5-3](#)). Do not tighten the screws any further.  
**Note:** The correct torque is indicated by means of the welded indicating spring.
9. Perform an OHM test to make sure the thyristor is ok.
10. Reconnect the DC – busbars, branch fuses and all other dismantled parts.
11. Perform an OHM test between U1, V1, W1 and C1, D1 to make sure the power part is ok.

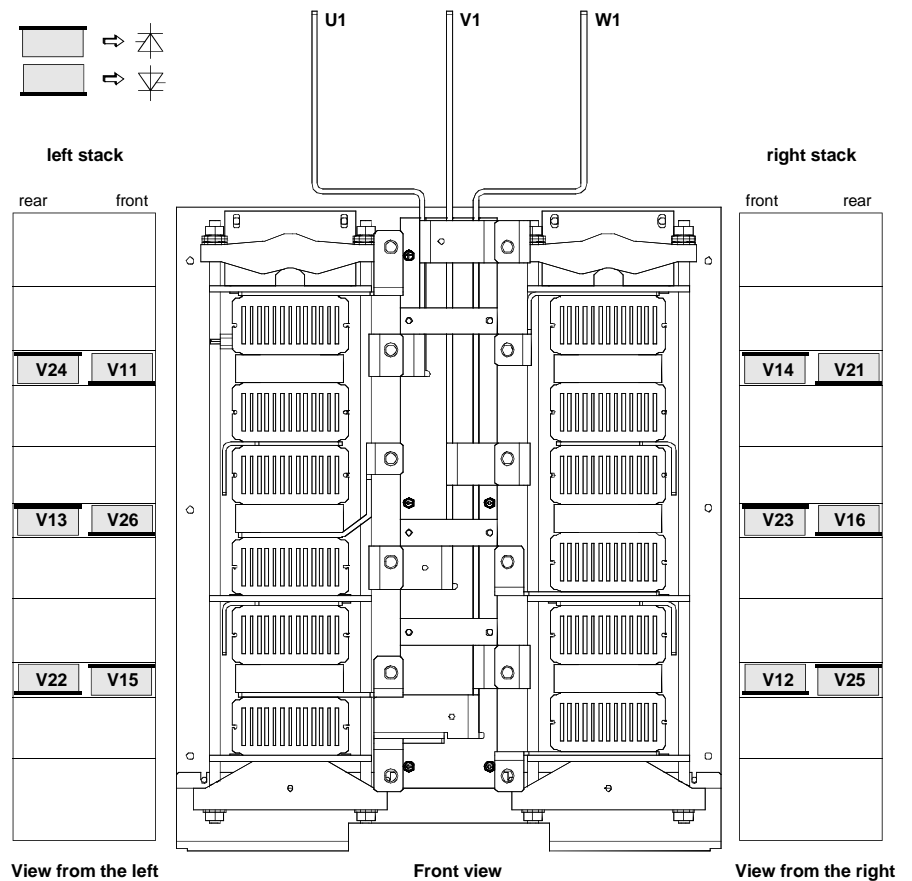

Figure 5-4 Location of thyristors in frame A5 (4-Q bridge)

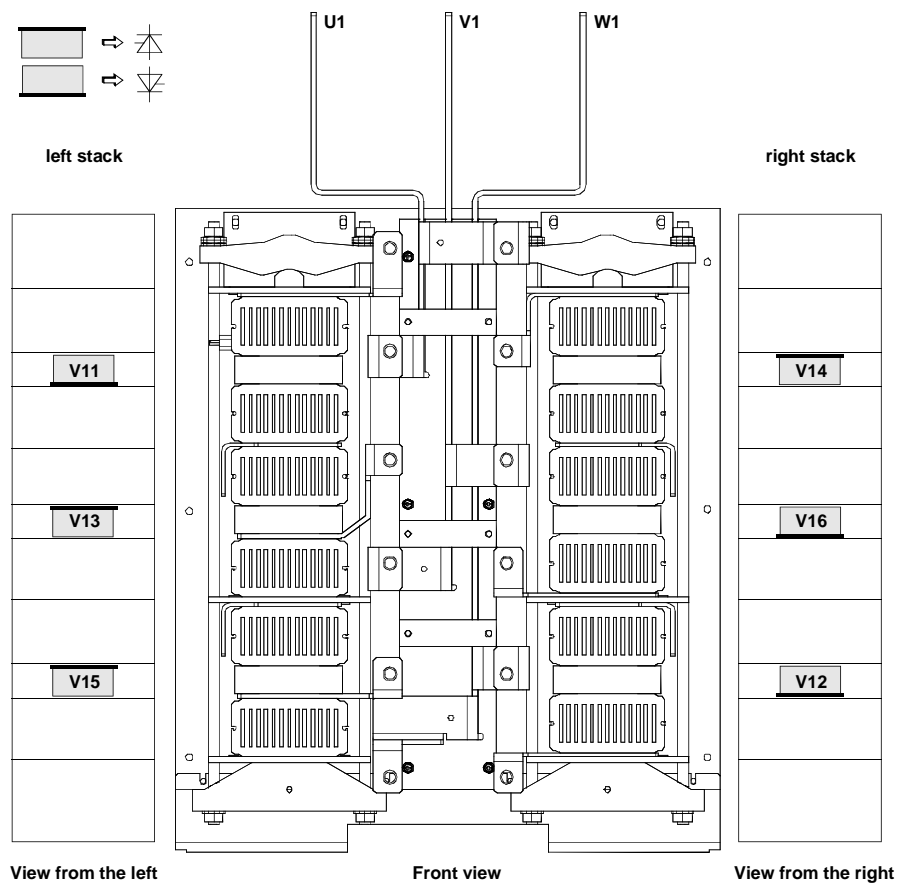

Figure 5-5 Location of thyristors in frame A5 (2-Q bridge)

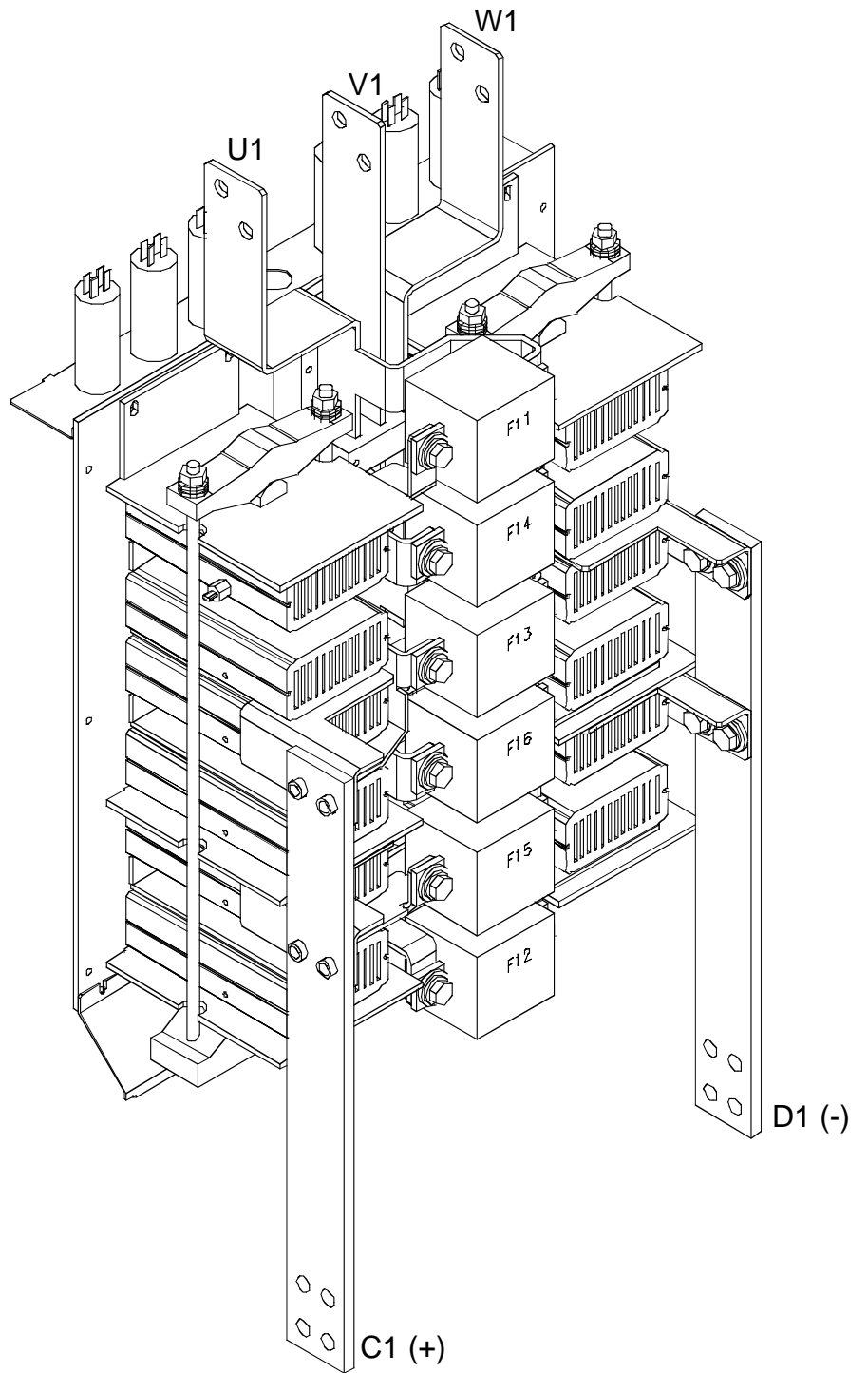

Figure 5-6 Location of branch fuses frame A5

*Chapter 5 - Exchange of Thyristors for Size A5*



## Chapter 6 - Exchange of Thyristors for Size A6

---

### **Installation of "Disc Type" thyristor in converters size A6 (1900...3000 A)**

All DCS 500B and DCS 600 converters sizes A5/A6/A7/C3/C4 are equipped with disk type thyristors. The structure of the "Disc type" semiconductor component is such that it requires a certain compression force to operate. The prevention of overheating of the component essentially depends on a well heat dissipation between the semiconductor and the conducted heat sink. It is thus important that all joints have good thermal and electrical conduction.

#### **Required Tools**

Special tools or material needed in addition to standard tools for the exchange of thyristor modules:

- Torque spanner for electrical connections: 13 Nm (M8)  
25 Nm (M10)  
50 Nm (M12)
- Screws are metric type; use appropriate nuts.
- 17 mm ring spanner for fuse and busbar connections.
- 24 mm ring spanner for press clamp.
- Tissue paper / solvent (e.g. ethanol).
- Thermal joint compound: type **BECHEM-RHUS SU 2** (grease)
  - Manufacturer: Carl Bechem GmbH, 58089 Hagen
  - ABB Service: GHSN 390 001 P 0001
- Disassembly tool DCF 1066721 P1

**Note:** For more detailed information about the wiring of the power part, see manual *Technical Data*.

Therefore strict observance of the build in instructions given below is of utmost importance. Make sure that the new component can replace the old one in accordance with the spare part list ([see Appendix A](#)).

Semiconductors and heat sinks are to be handled carefully to avoid scratches and other damage. Avoid touching the contact surfaces. Do not lift the semiconductor with the gate wire. Do not lift the semiconductor by touching the current contact surfaces. Do not damage the welding flange or the contact surface.



**Before you start work, disconnect the converter completely from the power supply then check the voltage free condition and make sure, everything is located in an electrically and mechanically safe condition!**

**BCT thyristors**

In some converter module size A6 so called BCT's (**B**idirectional-**C**ontrolled-**T**hystors) are used. BCT's are a pair of anti parallel thyristors in one disk type housing. They can easily identified by the second pair of gate leads. The second gate is marked with **Gate B** on the thyristor.

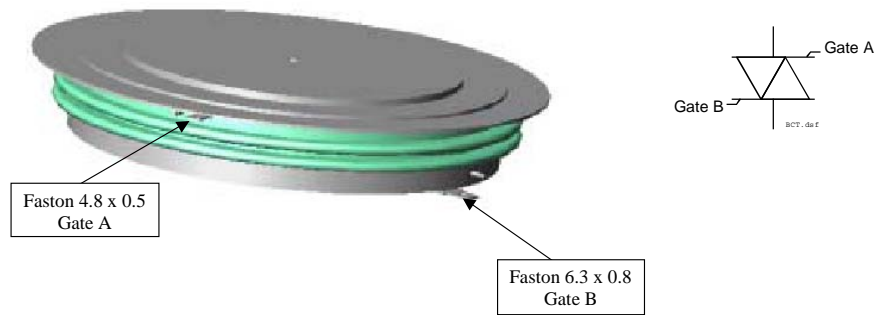

Figure 6-1 Gates of BCT

**Note:** The faston connectors of the gates are of different size.

Gate B should always be in front of the clamped heat sinks due to cooling reasons.

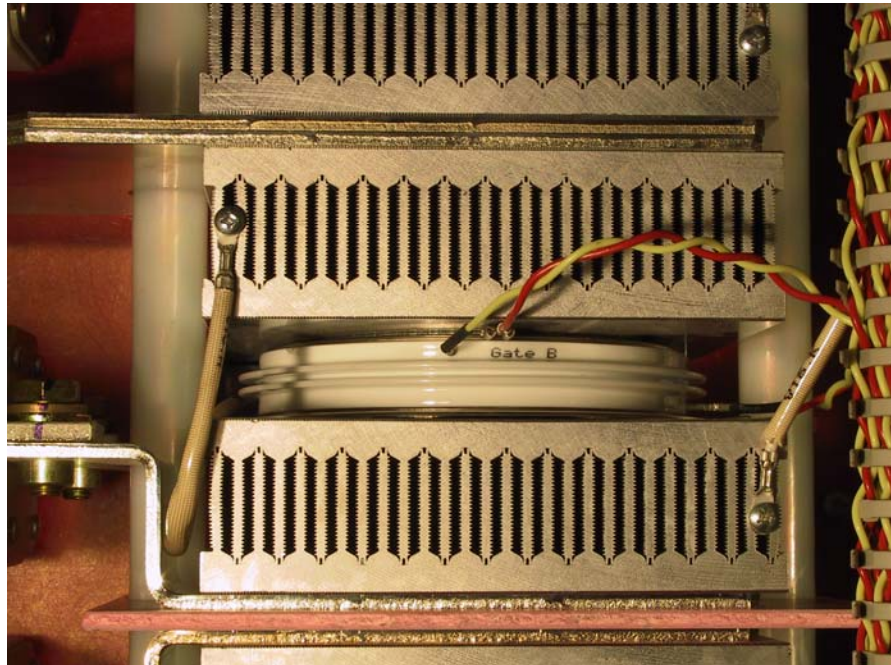

Figure 6-2 Location of BCT's gate B when built in

**Find faulty thyristor**

1. Find the defective branches by performing an OHM test (both polarities) between U1, V1, W1 and C1, D1 ([see figure 5-1](#)).
2. Disconnect the branch fuses of the defective branches.
3. Find the defective thyristors by performing an OHM test (both polarities) over their heat sinks.
4. In a 4 - quadrant converter with BCT's change the BCT.
5. In a 4 - quadrant converter with 2 single thyristors change both thyristors clamped between the same heatsinks at once.

**Note:** Because "Disc Type" semiconductors need a certain compression force to operate properly a measurement outside the clamped heat sinks might be wrong. To be sure change only one thyristor, clamp the heat sinks again and repeat step three.

**Remove faulty thyristor**

1. Replace all blown fuses and reconnect all fuses taken out during search for the faulty thyristor.
2. Remove the screws of the DC - busbar plates adjacent to the defective thyristors.

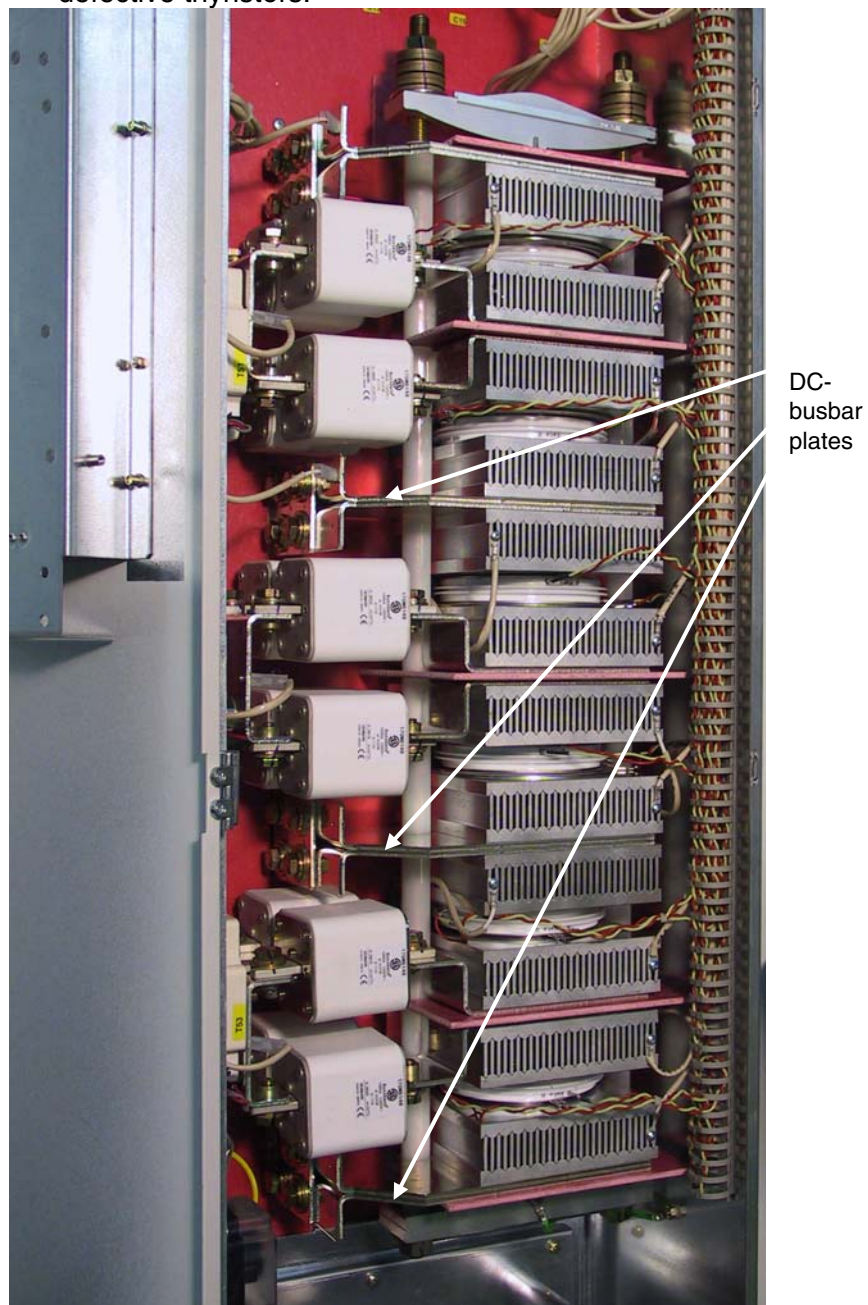

Figure 6-3 Location of the DC - busbar plates

**Note:** It depends on the location of the defective thyristor which DC-busbar plates have to be disconnected.

3. Write down the direction and location of the thyristors to be removed and mark their gate leads. In case of BCT's add the position of the gates.
4. Remove the gate leads if possible.
5. Loosen the mounting clamp at the top of the thyristor stack.

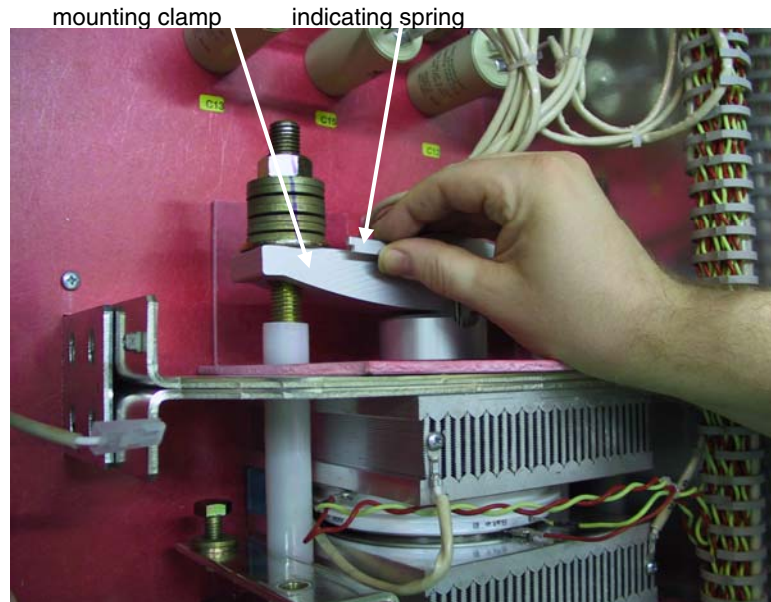

Figure 6-4 Handling of indicating spring and mounting clamp

**Attention:** While loosening the mounting clamp the indicating spring must be pulled out a little, otherwise the spring will be damaged! Do not remove the nuts totally, otherwise the threaded rods will fall down!

6. Pull out both DC-busbar plates.

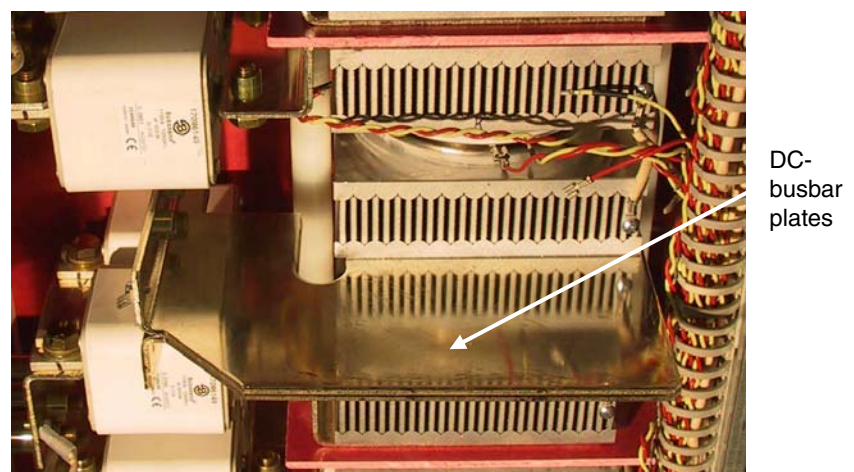

Figure 6-5 DC-busbar plates

7. Attach the disassembly tool at the faulty thyristor and prize open the upper and lower heat sinks.

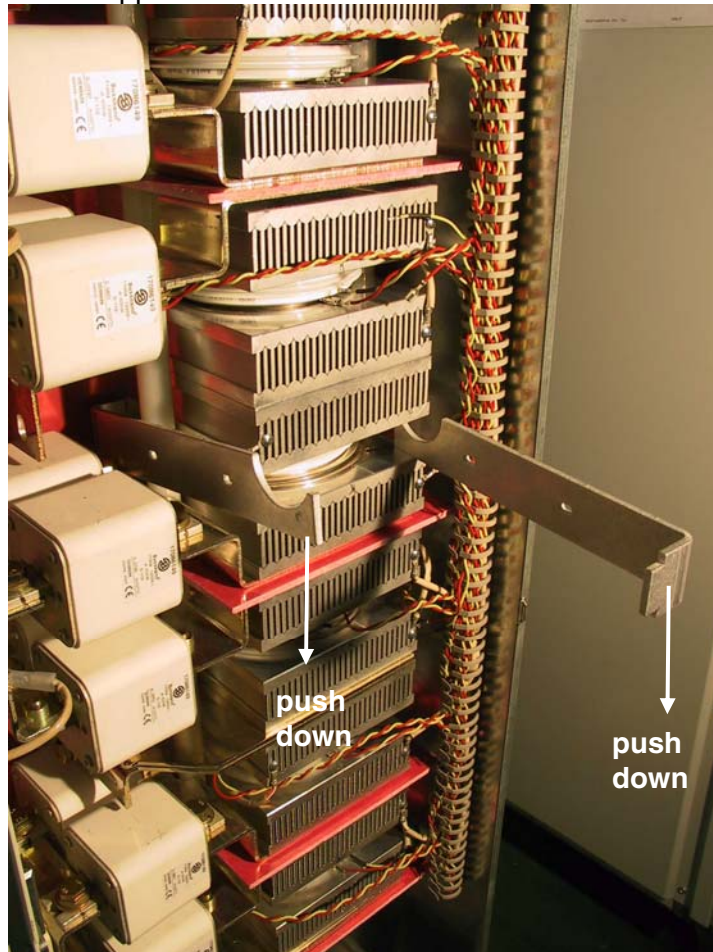

Figure 6-6 Use of disassembly tool

8. Remove the thyristors with e.g. a pair of pliers.

**Attention:** To centre the thyristors spring pins are used. The pins are inlaid into all lower heat sinks. Open the gap wide enough that the thyristor and the pins are not damaged while removing the thyristor!

**Install new thyristor**

1. Ensure that the new thyristor is of the correct type ([see appendix A](#)). Keep the semiconductor and its surroundings clean. If necessary clean them with a piece of tissue paper moistened with solvent.  
**Note:** Do not touch the polished surfaces of the thyristor.
2. Clean the polished surfaces of the semiconductor with a piece of tissue paper moistened with solvent. Dry all surfaces. Spread a **thin** layer of heat conducting paste on both sides of the thyristor, if necessary use a rubber spatula.



Figure 6-7 Prepare disk type thyristor

3. Clean all parts with tissue paper moistened with solvent, which have had or will have contact with the thyristor or each other (lower / upper heat sink). Do not clean the surfaces of grease too thoroughly, because the aluminum surfaces will oxidize in a few seconds. Dry all surfaces.
4. Centre the thyristors by means of the spring pins.  
**Note:** Be sure that the thyristor is installed in the right direction. Do not pinch or cut the gate leads or any other cable.
5. Turn the thyristor so that the gate leads point in the right direction. When changing BCT's make sure, that gate B is in front ([see figure 6-1](#)).
6. Connect the gate leads if possible.
7. Insert first the top DC-busbar plate and then the bottom one.

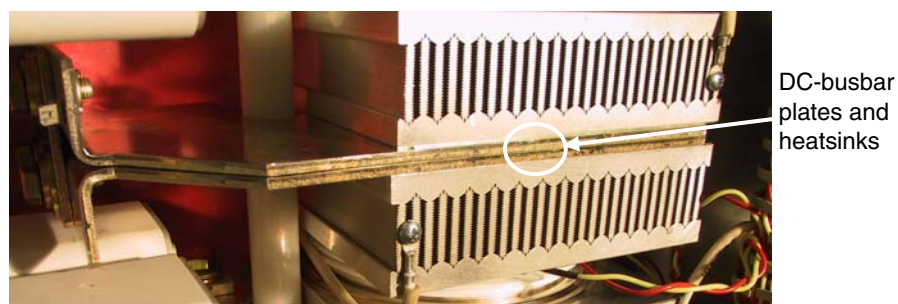

Figure 6-8 DC-busbar plates and adjacent heat sinks

**Note:** The DC - busbar plates should line up with the adjacent heat sinks.

8. Reconnect the DC-busbars.
9. Tighten the nuts of the mounting clamp by hand so that the clamp is in parallel with the contact surface of the heat sinks.

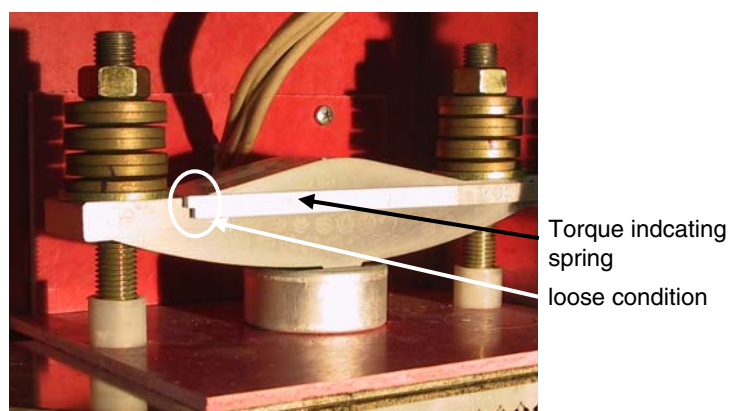

Figure 6-9 Mounting clamp; loose condition

**Note:** The indicating spring is a very sensitive instrument and must be handled with care.

10. Tighten each nut in turn, half a turn at a time with the help of a ring spanner until the indicating spring clicks into position "correct torque". Do not tighten the screws any further.



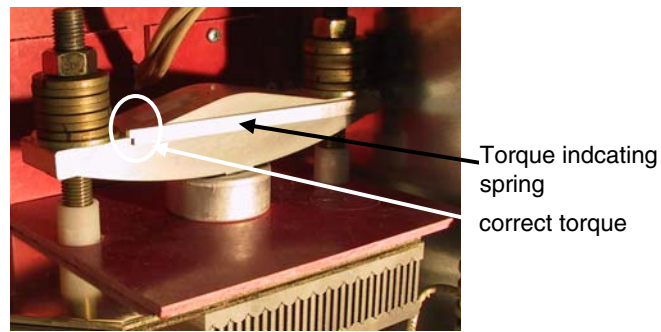

Figure 6-10 Mounting clamp, correct torque

**Note:** The correct torque is indicated by means of the welded indicating spring.

11. Perform an OHM test to make sure the thyristor is ok.
12. Reconnect all other dismantled parts.
13. Perform an OHM test between U1, V1, W1 and C1, D1 to make sure the power part is ok.

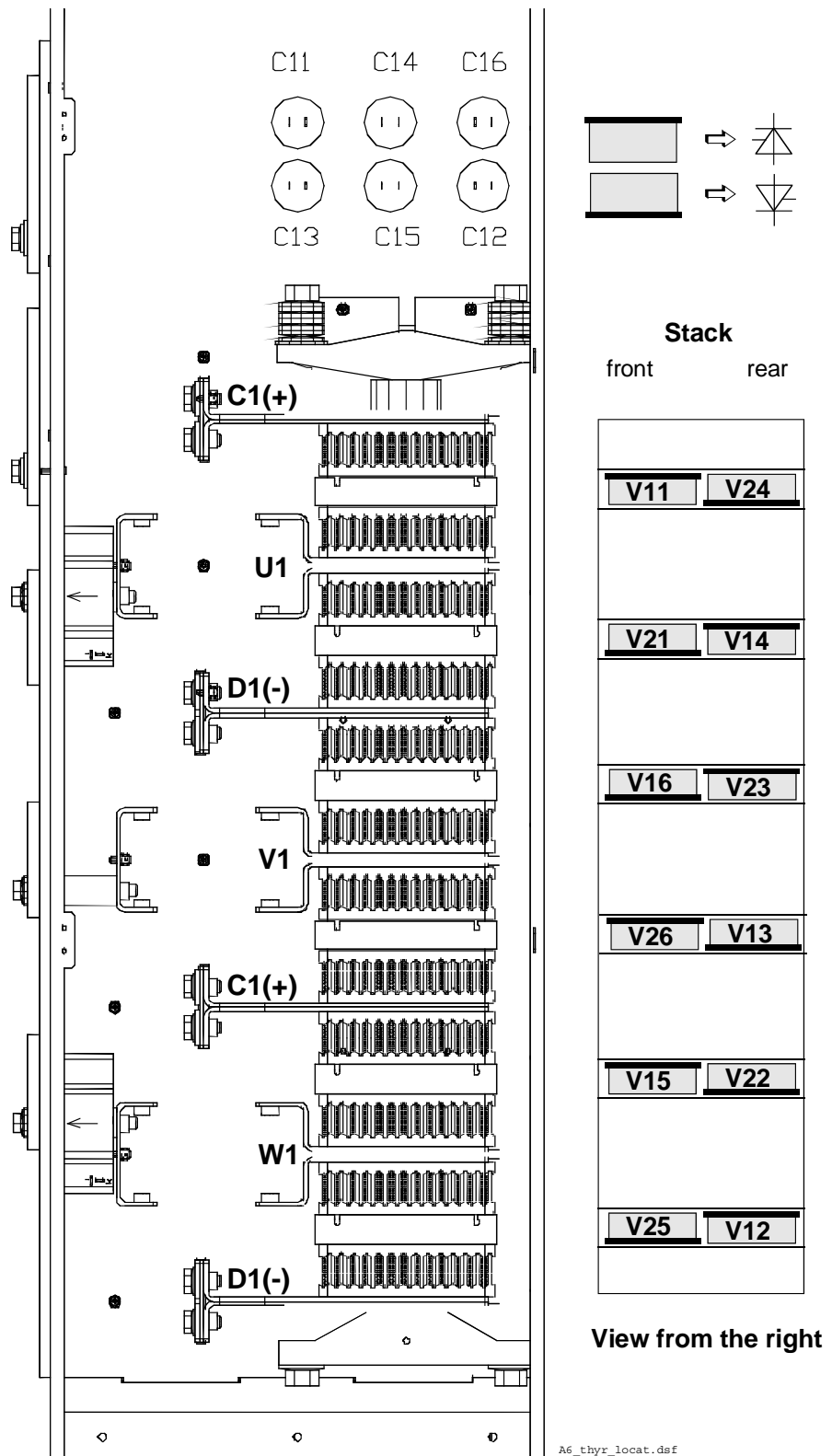

Figure 6-11 Location of thyristors in frame A6 (4-Q bridge with single thyristors).

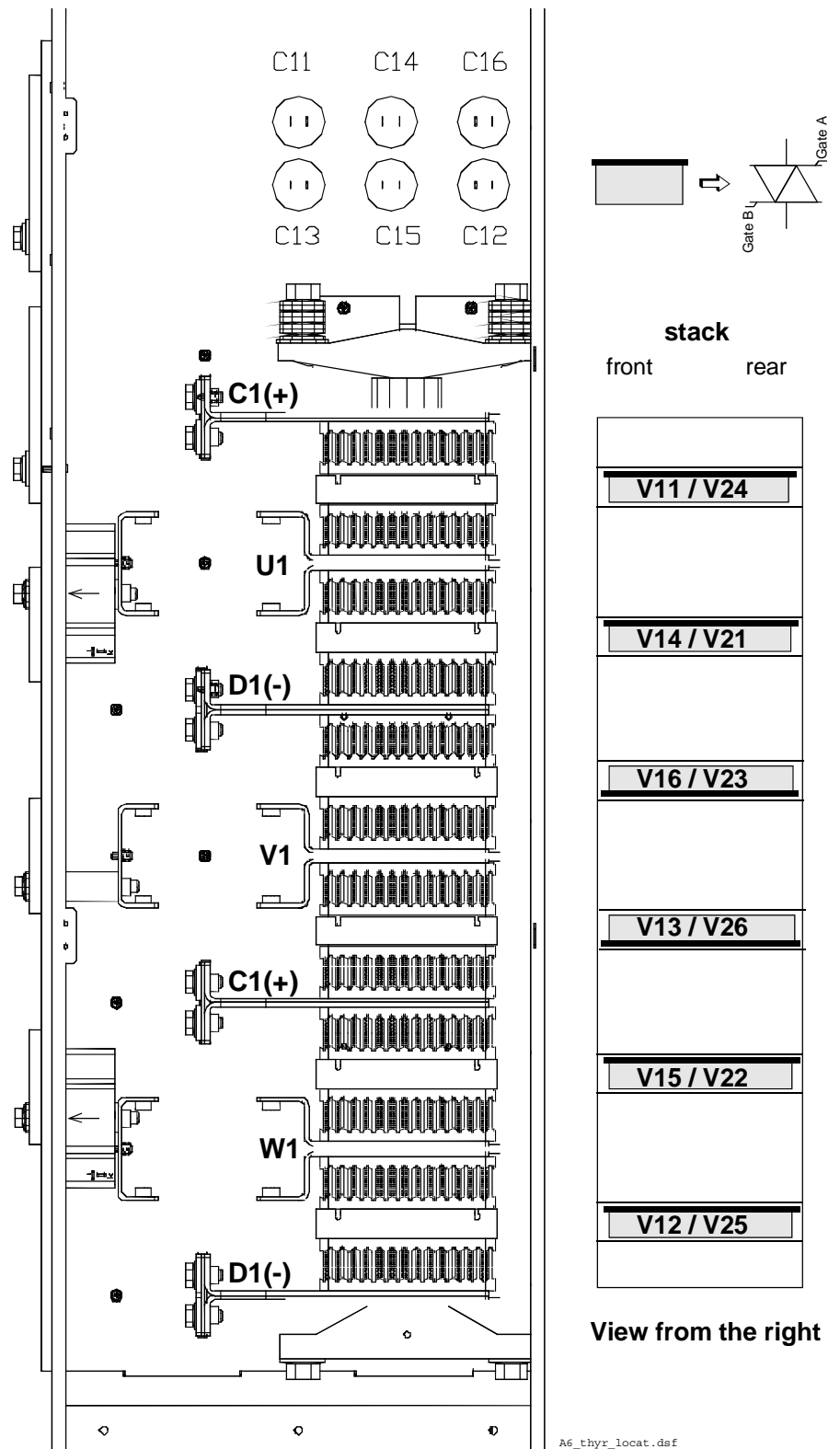

Figure 6-12 Location of thyristors in frame A6 (4-Q bridge with BCT's)

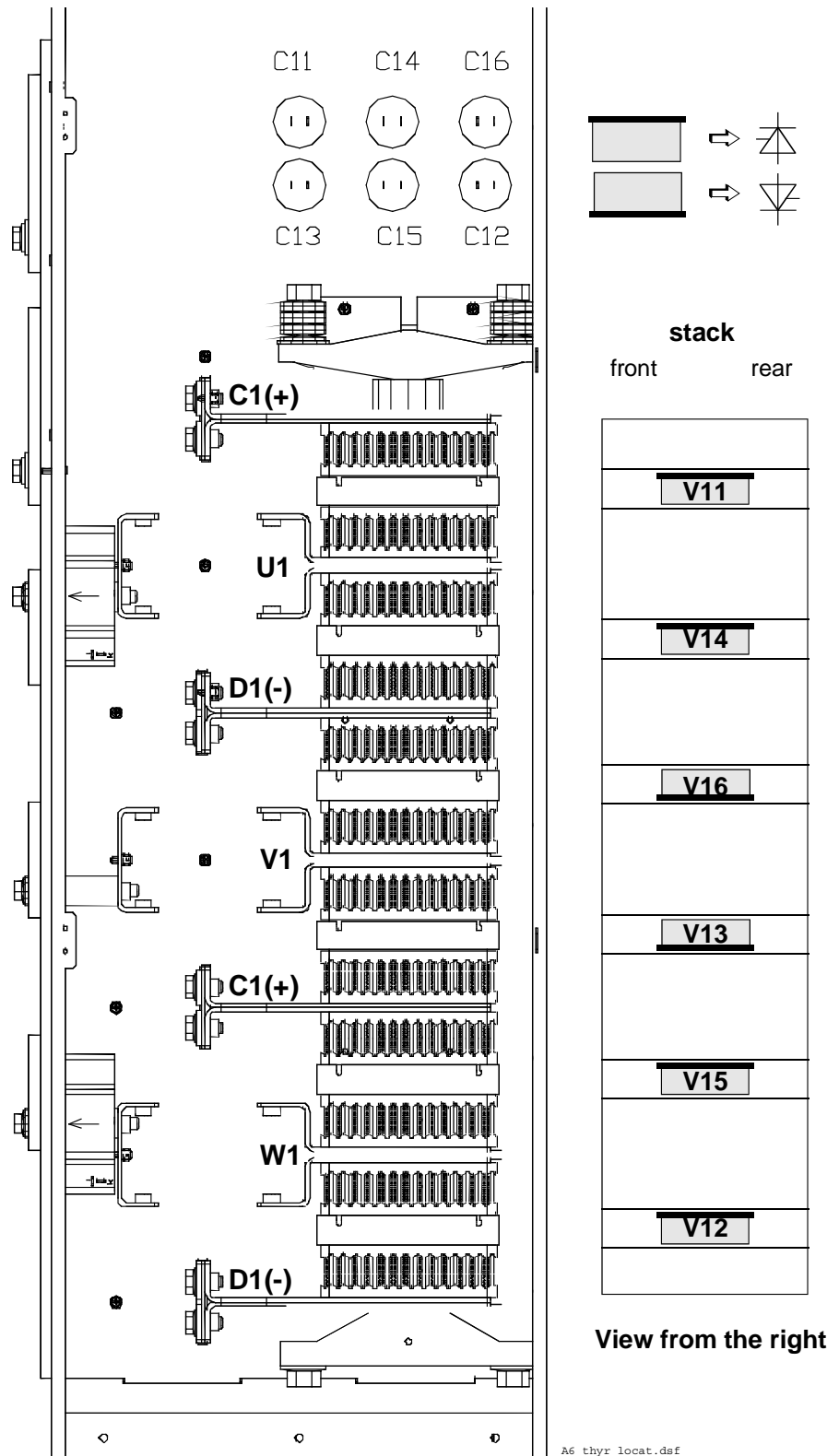

Figure 6-13 Location of thyristors in frame A6 (2-Q bridge with single thyristors)

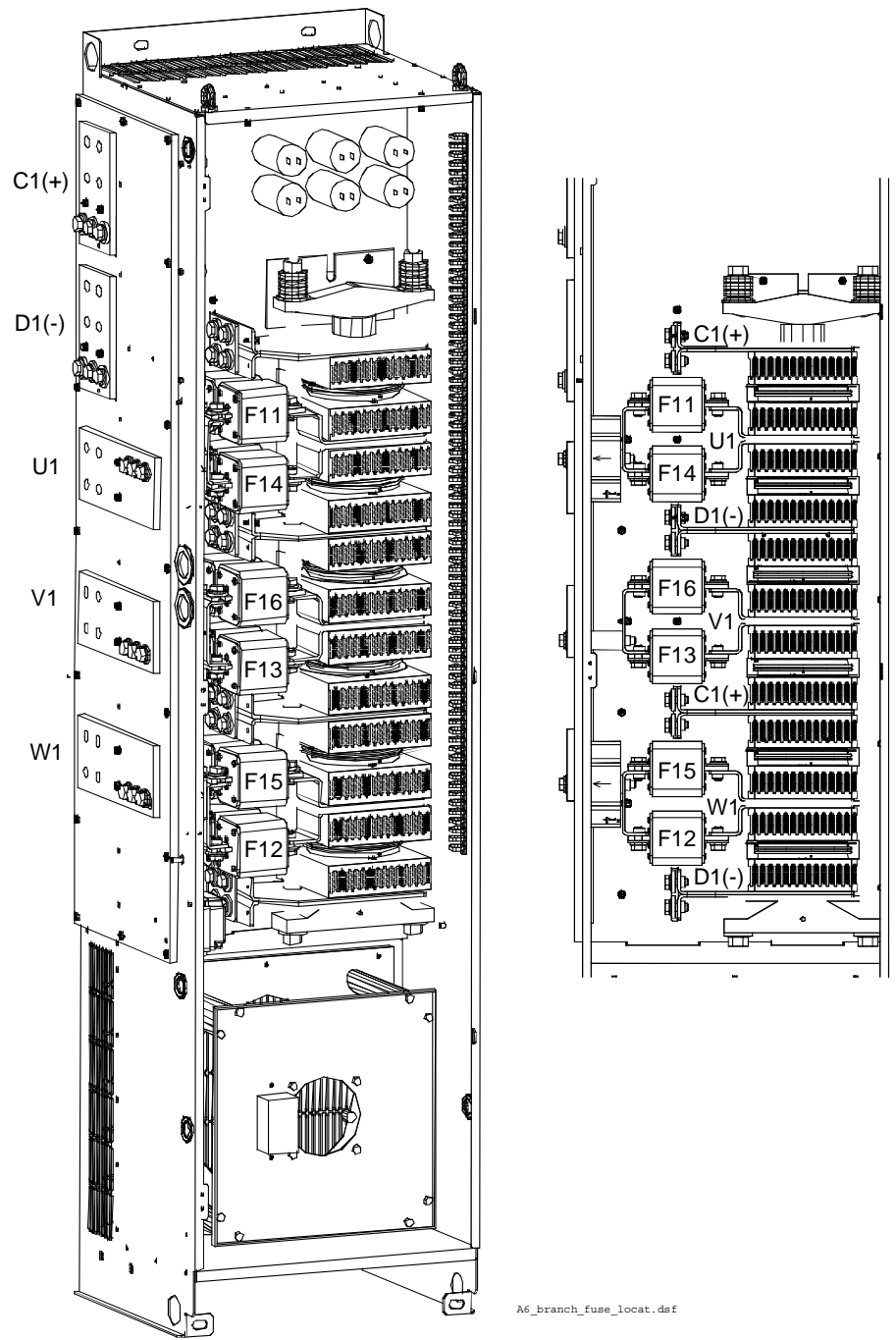

Figure 6-14 Location of parallel branch fuses frame A6

*Chapter 6 - Exchange of Thyristors for Size A6*



**Find faulty thyristor**

1. Find the defective branches by performing an OHM test (both polarities) between U1, V1, W1 and C1, D1 ([see Figure 5-1](#)).
2. Remove the AC busbars, of the defective branches.

**4-quadrant converter:**

3. Remove all screws of the DC - busbars either above or below the fuses of the defective branches.

**Note:** The connection is made with a screw socket, which may fall down, when all screws are removed.

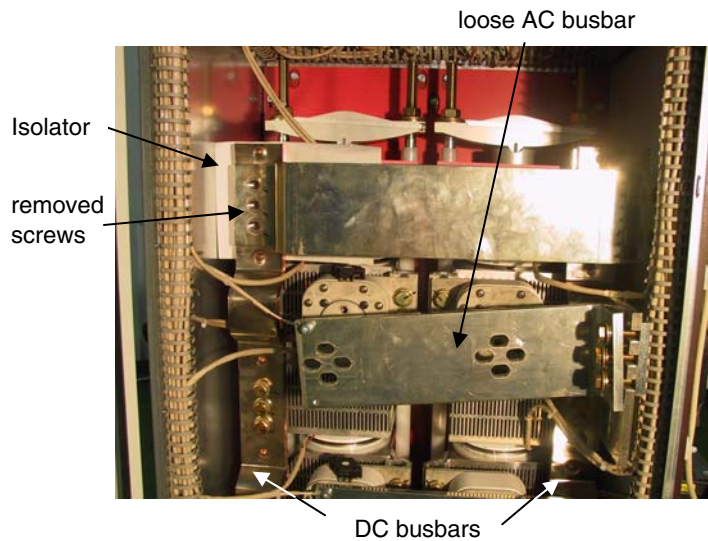

Figure 7-1 Location of busbars

4. Put a small piece of isolator (e.g. paper) between the DC - busbar and the heat sink to insulate the anti parallel thyristors from each other.
5. Find the defective thyristors by performing an OHM test (both polarities) over their heat sinks.

**2 - quadrant converter:**

3. Find the defective thyristors by performing an OHM test (both polarities) over their heat sinks.



**Remove faulty thyristor**

1. Remove the screws of all DC / AC - busbars preventing the stack to be prized open. Remove the branch fuses, if the defective thyristors are covered by them.

**Note:** It depends on the location of the defective thyristors, which DC / AC - busbars have to be disconnected.

2. Loosen the screws holding the backplate and make sure the backplate can move up.

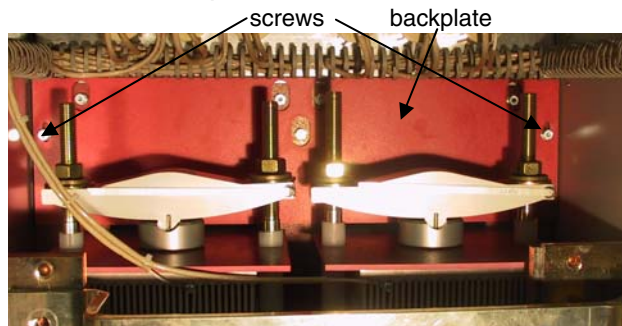

Figure 7-2 Backplate

3. Write down the direction and location of the defective thyristors to be removed and mark their gate leads.
4. Remove the gate leads if possible.
5. Loosen the mounting clamp at the top of the thyristor stack.

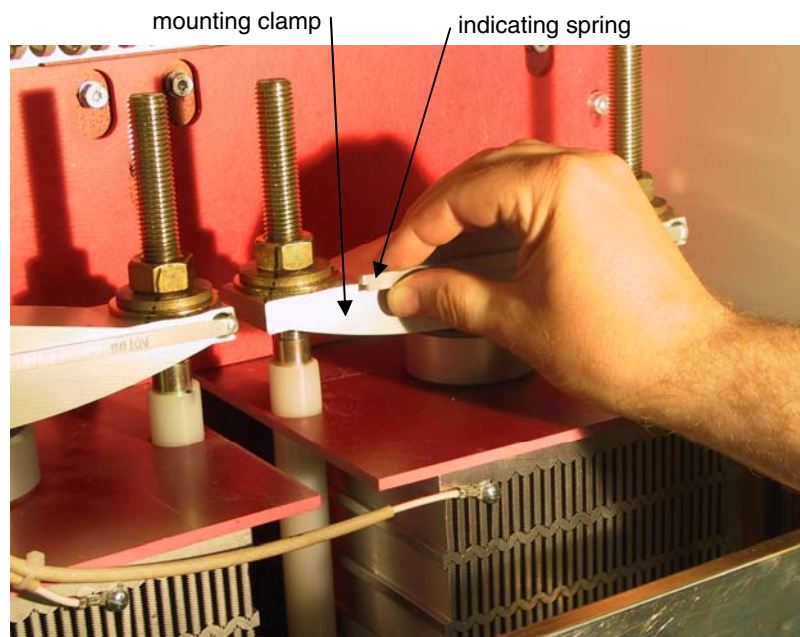

Figure 7-3 Handling of indicating spring and mounting clamp

**Attention:** While loosen the mounting clamp the indicating spring must be pulled out a little, otherwise the spring will be damaged! Do not remove the nuts totally, otherwise the threaded rods will fall down!

6. Attach the disassembly tool at the faulty thyristor and prize open the upper and lower heat sinks.

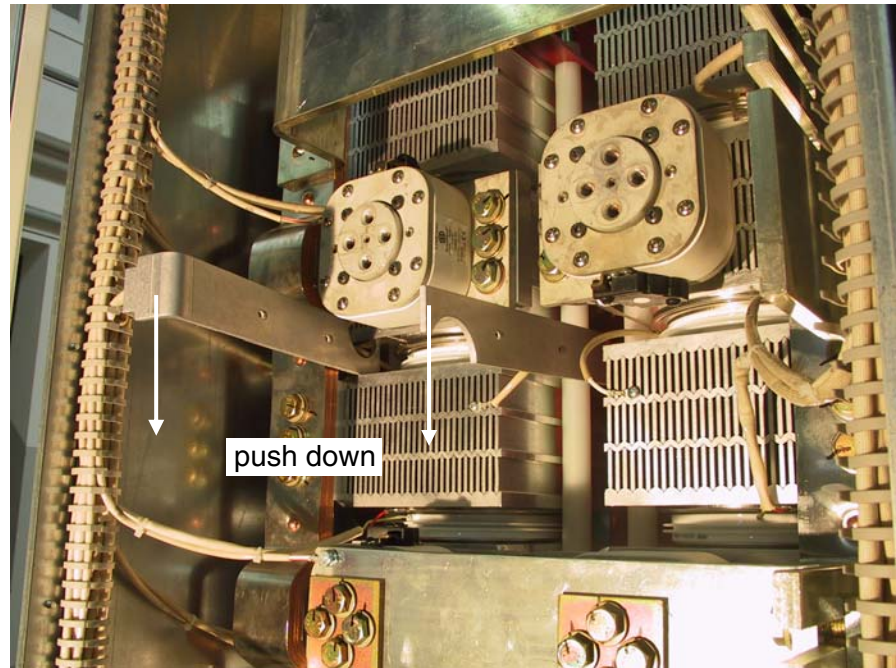

Figure 7-4 Use of disassembly tool

7. Remove the thyristors with e.g. a pair of pliers.

**Attention:** To centre the thyristors spring pins are used. The pins are inlaid into all lower heat sinks. Open the gap wide enough that the thyristor and the pins are not damaged while removing the thyristor!

**Install new thyristor**

1. Ensure that the new thyristor is of the correct type ([see appendix A](#) of this manual). Keep the semiconductor and its surroundings clean. If necessary clean them with a piece of tissue paper moistened with solvent.

**Note:** Do not touch the polished surfaces of the thyristor.

2. Clean the polished surfaces of the semiconductor with a piece of tissue paper moistened with solvent. Dry all surfaces. Spread a **thin** layer of heat conducting paste on both sides of the thyristor, if necessary use a rubber spatula.



Figure 7-5 Prepare disk type thyristor

3. Clean all parts with tissue paper moistened with solvent, which have had or will have contact with the thyristor or each other (lower / upper heat sink). Do not clean the surfaces of grease too thoroughly, because the aluminum surfaces will oxidize in a few seconds. Dry all surfaces.
4. Centre the thyristors by means of the spring pins.  
**Note:** Be sure that the thyristor is installed in the right direction. Do not pinch or cut the gate leads or any other cable.
5. Turn the thyristor so that the gate leads point in the right direction.
6. Connect the gate leads if possible.
7. Tighten the nuts of the mounting clamp by hand so that the clamp is in parallel with the contact surface of the heat sinks.

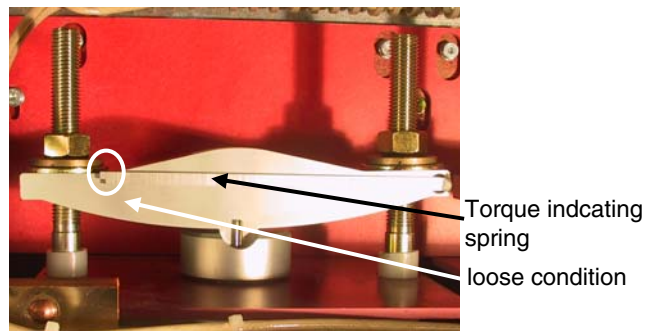

Figure 7-6 Mounting clamp; loose condition

**Note:** The indicating spring is a very sensitive instrument and must be handled with care.

8. Tighten each nut in turn, half a turn at a time with the help of a ring spanner until the indicating spring clicks into position “correct torque”. Do not tighten the screws any further.

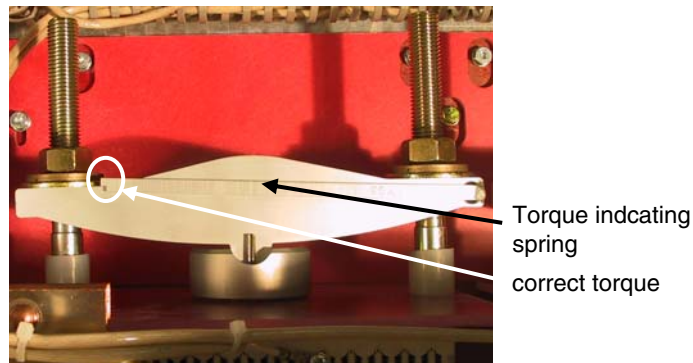

Figure 7-7 Mounting clamp; correct torque

**Note:** The correct torque is indicated by means of the welded indicating spring.

9. Perform an OHM test to make sure the thyristor is ok.
10. Reconnect the backplate, branch fuses, DC- / AC-busbars and all other dismantled parts.
11. Perform an OHM test between U1, V1, W1 and C1, D1 to make sure the power part is ok.

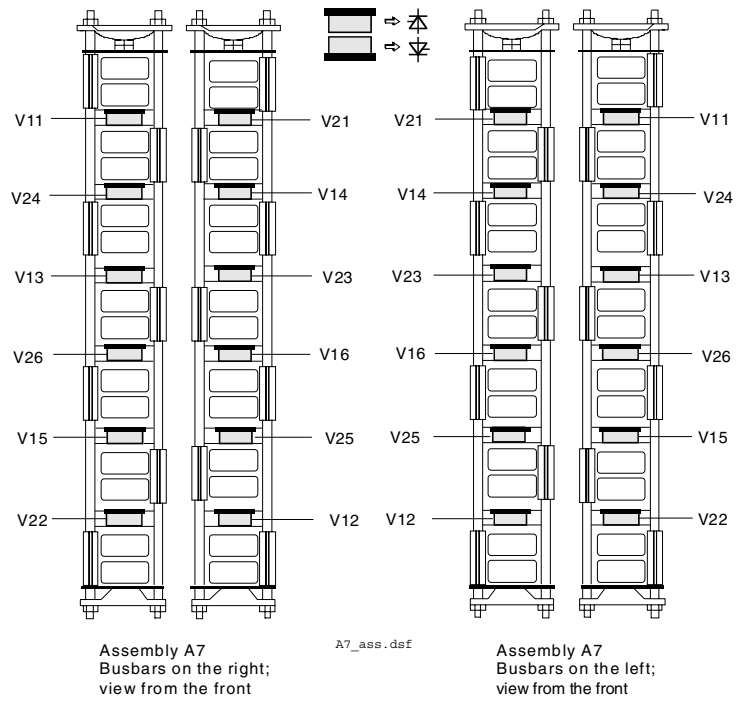

Figure 7-8 Location of thyristors in frame A7 (4-Q bridge)

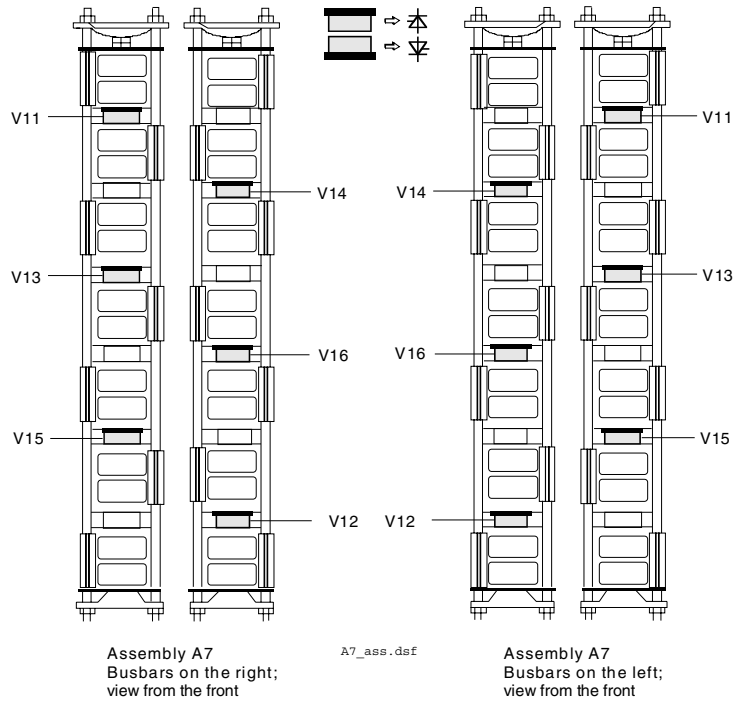

Figure 7-9 Location of thyristors in frame A7 (2-Q bridge)

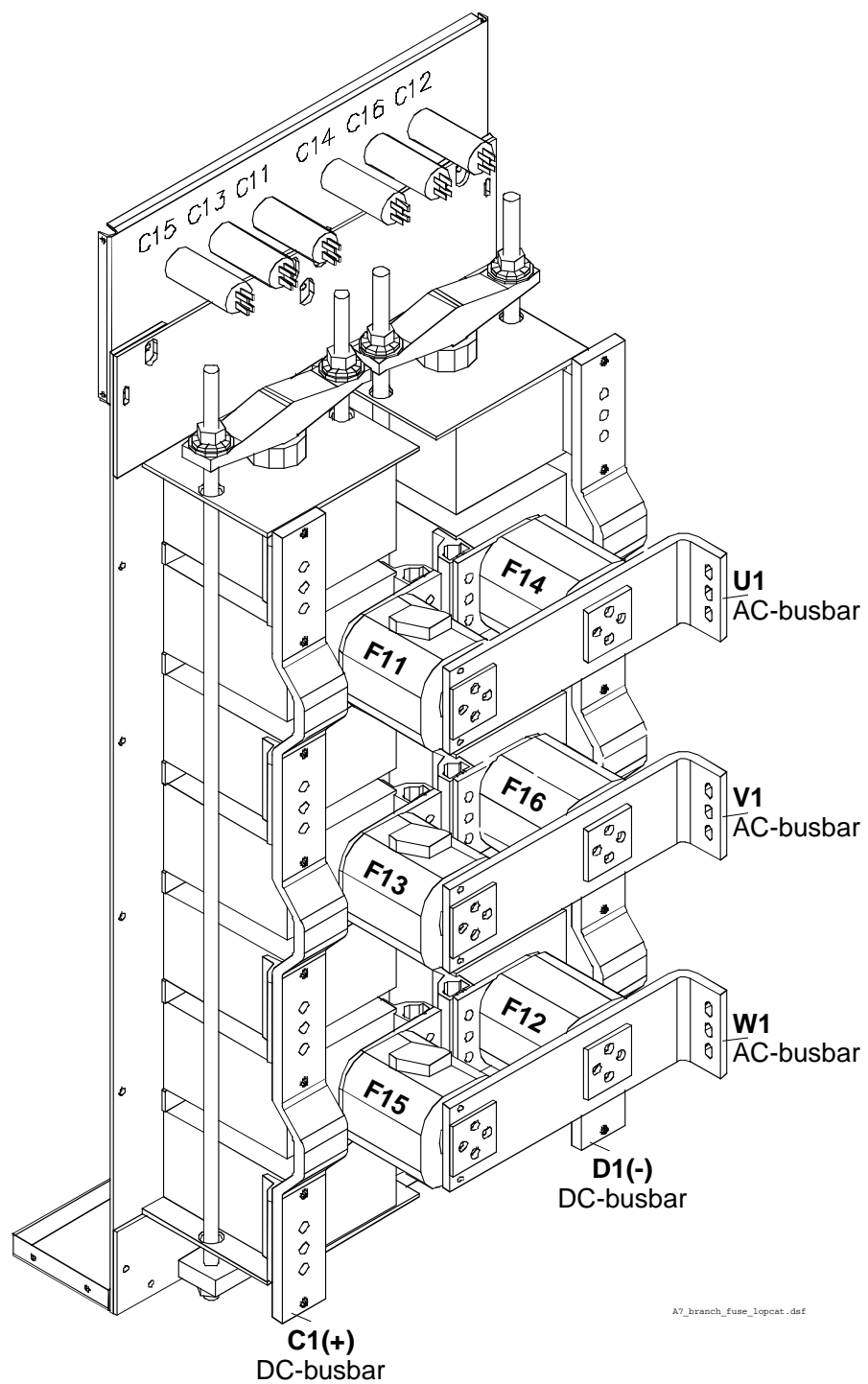

Figure 7-10 Location of branch fuses frame A7 (busbars on the right)

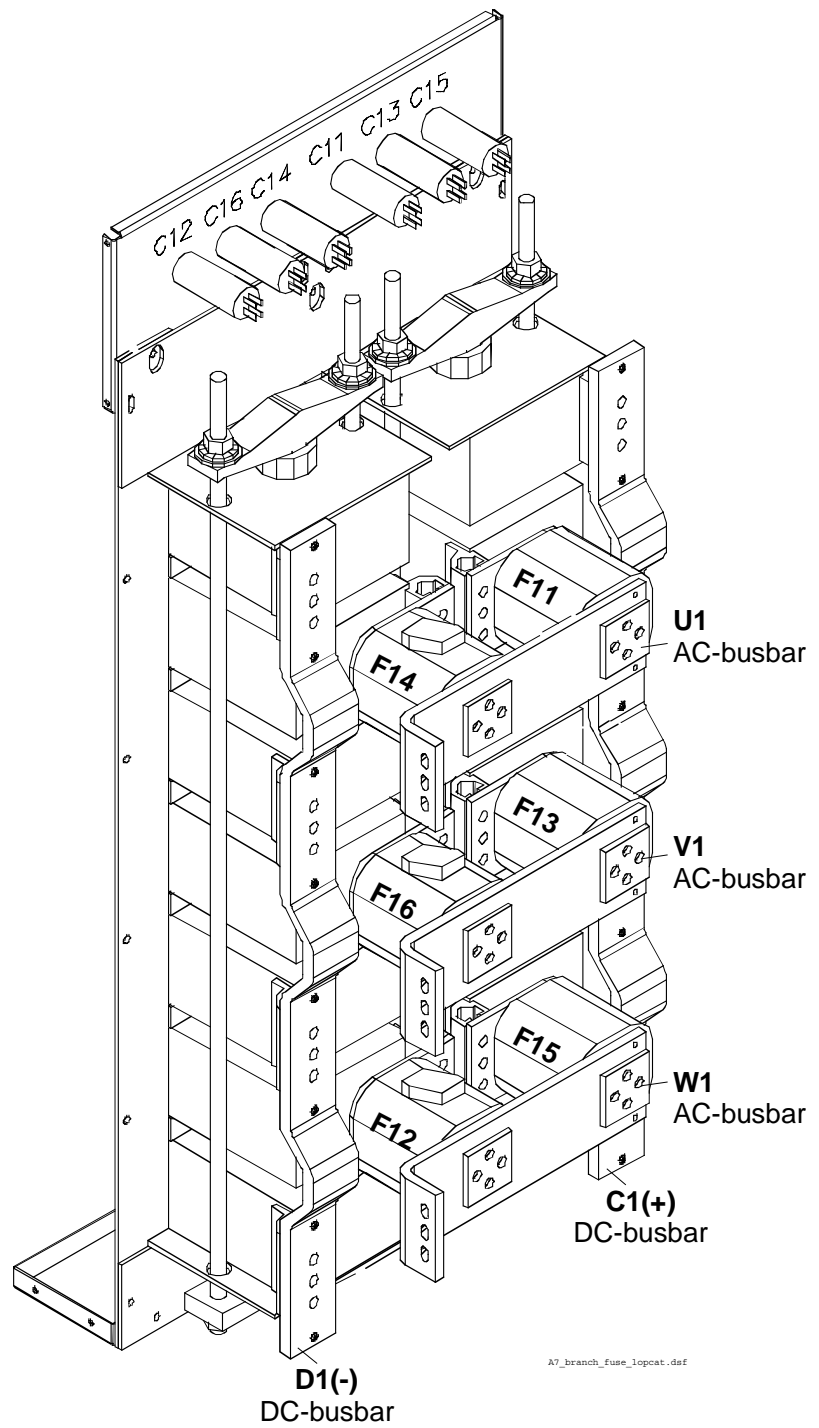

Figure 7-11 Location of branch fuses frame A7 (busbars on the left)

*Chapter 7 - Exchange of Thyristors for Size A7*



## Chapter 8 - Exchange of Thyristors for Size C3

---

### **Installation of "Disc Type" thyristor in converters size C3 (900...2000 A)**

All DCS 500B and DCS 600 converters sizes A5/A6/A7/C3/C4 are equipped with disk type thyristors.

The structure of the "disc type" semiconductor component is such that it requires a certain compression force to operate. The prevention of overheating of the component essentially depends on a well heat dissipation between the semiconductor and the conducted heat sink. It is thus important that all joints have good thermal and electrical conduction.

#### **Required Tools**

Special tools or material needed in addition to standard tools for the exchange of thyristor modules:

- Torque spanner: mounting torques and forces for disc type thyristors [see Table 8-1](#)  
electrical connections: 13 Nm (M8)  
25 Nm (M10)  
50 Nm (M12)
- Screws are metric type; use appropriate nuts.
- 13 mm nut for thyristor fixing with 20 mm max outer diameter.
- Tissue paper / solvent (e.g. ethanol).
- Molikote (MSO<sub>2</sub>).
- Thermal joint compound: type **BECHEM-RHUS SU 2** (grease)  
Manufacturer: Carl Bechem GmbH, 58089 Hagen  
ABB Service: GHSN 390 001 P 0001

**Note:** For more detailed information about the wiring of the power part, see publication *Technical Data*.

Therefore strict observance of the build in instructions given below is of utmost importance. Different press clamps are used, depending on the size of the semiconductor. Make sure that the new component can replace the old one in accordance with the spare part list ([see Appendix A](#)).



**Before you start work, disconnect the converter completely from the power supply then check the voltage free condition and make sure, everything is located in an electrically and mechanically safe condition!**

**Remove faulty thyristor**

- Remove the plastic cover in front of the heat sinks; the screws are accessible, if the SDCS-PIN-x1 boards will be unfastened; there is no need to disconnect the electrical connections at the PIN-x1 boards.
- Remove the fuse, connected to that thyristor (pair) which needs to be exchanged.
- Disconnect the lead of a snubber capacitor connected to the heat sink; if the very right or left plastic cover is fixed at the heat sink, which needs to be removed remove the screw.
- If you have a 2 quadrant converter:
  - Loosen the screws, which keep the press clamp and the heat sink in position; remove the heat sink, mark the direction of the thyristor and the position of the gate leads, then remove the thyristor.
- If you have a 4-quadrant type converter:
  - Always start working at that thyristor which is part of the reverse bridge (V21, V22 a.s.o.) loosen the screws, which keep the press clamp and the heat sink in position; remove the heat sink, mark the direction of the thyristor and the position of the Gate leads, then remove the thyristor.

**Find faulty thyristor**

- Perform the OHM test with both polarities. Use the DC terminal of the antiparallel thyristors connected as one measuring point and the remaining heat sink as the other.
  - Case a) If this test indicates high resistance, the remaining thyristor is all right healthy and the one already removed should be marked and needs to be replaced.
  - Case b) If this test indicates low resistance, the remaining thyristor is faulty and needs to be replaced.  
Remove it in the way described above.  
The other thyristor is ok!
- In case a) of the OHM test described above mount a new thyristor at the position of the reverse bridge.
- In case b) of the OHM test described above a new thyristor for the forward bridge and afterwards the thyristor of the reverse bridge which was removed first have to be mounted.

**Install new thyristor**

- Ensure that the new thyristor is of the correct type ([see Appendix A](#)). Keep the semiconductor and its surroundings clean. If necessary clean them with a piece of tissue paper moistened with solvent. Make sure the insulator of the thyristor and the connections are fine.  
**Note:** Do not touch the polished surfaces of the thyristor.
- Clean the polished surfaces of the semiconductor with a piece of tissue paper moistened with solvent. Dry all surfaces. Spread a **thin** layer of heat conducting paste on both sides of the thyristor, if necessary use a rubber spatula.
- Clean all parts with tissue paper moistened with solvent, which have had or will have contact with the thyristor or each other (bottom of upper heat sink, busbar on both sides and upper side of the DC and AC busbar). Do not clean the surfaces of grease too thoroughly, because the aluminium surfaces will oxidise in a few seconds. Dry all surfaces.
- Connect the gate leads if possible.
- Place the thyristor with the right direction into the guiding tool. Spread the heat conducting paste by turning the thyristor 90° left and right.  
**Note:** Do not pinch or cut the gate leads or any other cable.
- Turn the thyristor so that the gate leads point in the right direction.

**Fasten the clamp**

- Spread a thin layer of Molikote (MSO<sub>2</sub>) on the thread and under the lower side of the head of each of the screws, keeping the heat sink by means of the press clamp in place. Spread Molikote also on the side of the washers, which comes in contact with the screw. Spread a thin layer of heat conducting paste on the bottom of the heat sink with a rubber spatula. Place the busbar and the heat sink above the thyristor and fix them with the press clamp. Tighten the clamping screws by hand until the screw heads touch the bottom of the module.

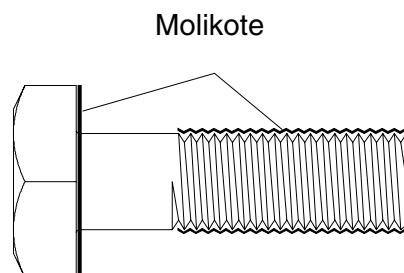

- Find the required torque from the table below. Tighten the screws alternatively 1/4 turn at a time until the correct torque is reached.

Converter type	Torque / Nm	Force / kN	Press clamp
<b>400 V - 500 V</b>			
DCS x0x-0900-4(5)	5,5 - 6	8 - 12	SLZF 89A
DCS x0x-1200-4(5)	5,5 - 6	8 - 12	SLZF 89A
DCS x0x-1500-4(5)	11,5 - 12	14,4 - 24	SLZF 89B
DCS x0x-2000-4(5)	11,5 - 12	14,4 - 24	SLZF 89B
<b>600 V - 690 V</b>			
DCS x0x-0900-6(7)	7,5 - 8	10 - 15	SLZF 89A
DCS x0x-1500-6(7)	11,5 - 12	14,4 - 24	SLZF 89B

Table 8-1 Mounting torques and forces for disc type thyristors

- In case of a 4-quadrant type converter:
  - Perform the OHM test with both polarities another time to make sure, the thyristor, which was used for the reverse bridge, is definitely healthy.
    - If this test indicates high resistance, the thyristor is healthy and can be used.
    - If this test indicates low resistance, the thyristor of the reverse bridge is faulty and needs to be replaced: remove it again mount a new one as described above.
- Install in the fuse(s).
- Connect the lead of the snubber capacitor, if it was removed before.
- Reconnect all parts, which were removed before:
  - plastic covers, etc.

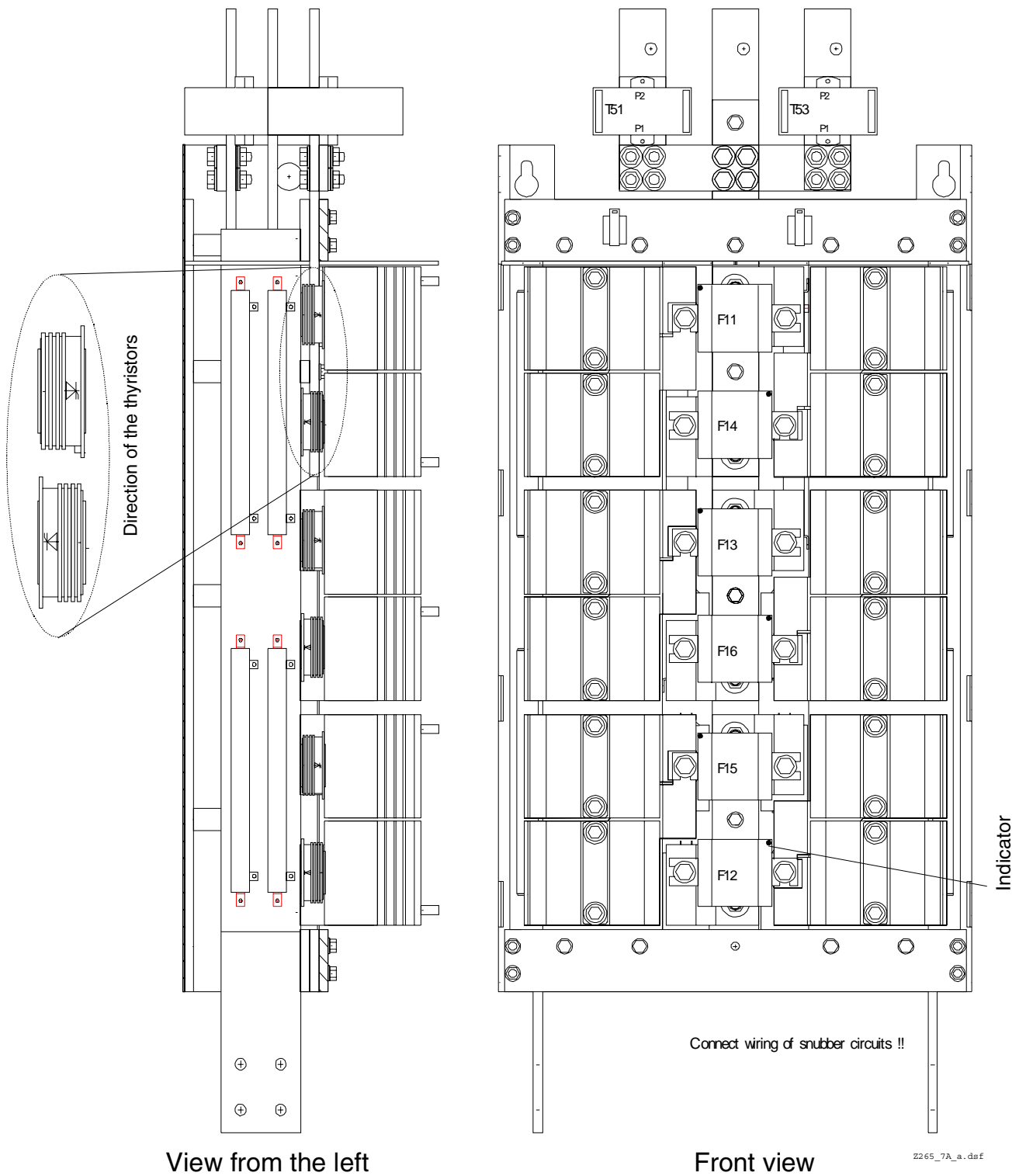

Figure 8-1 Location of thyristors in modules size C3

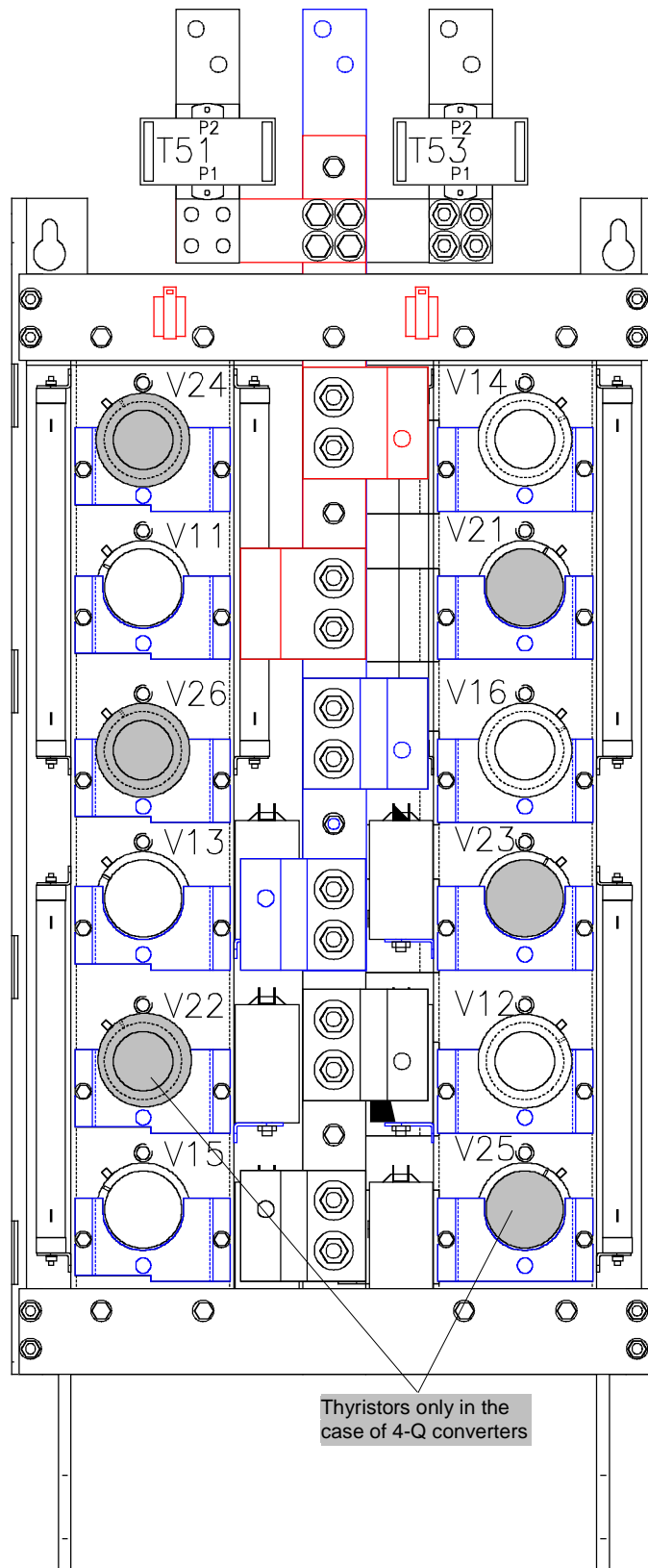

Figure 8-2 Location of thyristors in modules size C3  
**Note:** Removed fuses, busbars and upper parts of heat sinks

# Chapter 9 - Exchange of Thyristors for Size C4

## Installation of "Disc Type" thyristor in converters size C4 (2050...5150 A)

All DCS 500B and DCS 600 converters sizes A5/A6/A7/C3/C4 are equipped with disk type thyristors.

The structure of the "Disc type" semiconductor component is such that it requires a certain compression force to operate. The prevention of overheating of the component essentially depends on a well heat dissipation between the semiconductor and the conducted heat sink. It is thus important that all joints have good thermal and electrical conduction.

### Required Tools

Special tools or material needed in addition to standard tools for the exchange of thyristor modules:

- Torque spanner for electrical connections:
  - 13 Nm (M8)
  - 25 Nm (M10)
  - 50 Nm (M12)
- Screws are metric type; use appropriate nuts.
- 17 mm ring spanner for fuse and busbar connections.
- 24 mm ring spanner for press clamp.
- Tissue paper / solvent (e.g. ethanol).
- Thermal joint compound: type **BECHEM-RHUS SU 2** (grease)
  - Manufacturer: Carl Bechem GmbH, 58089 Hagen
  - ABB Service: GHSN 390 001 P 0001
- Disassembly tool: DCF 1066721 P1

**Note:** For more detailed information about the wiring of the power part, see publication *Technical Data*.

Therefore strict observance of the build in instructions given below is of utmost importance. Make sure that the new component can replace the old one in accordance with the spare part list ([see Appendix A](#)).

Thyristors are always mounted in the same direction, independent of current, voltage, number of quadrants (2-Q or 4-Q) version or left or right side connection. Semiconductors and heat sinks are to be handled carefully to avoid scratches and other damage. Avoid touching the contact surfaces. Do not lift the semiconductor with the gate wire. Do not lift the semiconductor unit by touching the current contact surfaces. Do not damage the welding flange or the contact surface.



**Before you start work, disconnect the converter completely from the power supply then check the voltage free condition and make sure, everything is located in an electrically and mechanically safe condition!**

**Find faulty thyristor**

- Find the defective branch(es) by performing an OHM test (both polarities) between U1, V1, W1 and C1, D1 ([see Figure 5-1](#)).
- Remove the screws of the left and right branch fuses. Remove the busbar, leading to the AC connection, too (not necessary at 2-quadrant converters, left version!).
- If you have a 4-quadrant converter:
  - Remove the screws of the DC busbar either above or below the blown fuse.  
**Note:** the connection is made with a screw socket, which may fall down, if the last screw is removed.
  - Put a small piece of isolator (paper, cardboard, plastic, etc.) between the DC busbar and the heat sink.
  - Perform the OHM test with both polarities between the DC busbar and the heat sink as the second measuring point.
  - Now perform the OHM test with both polarities between the isolated heat sink and the heat sink, which was connected to the fuse as the second measurement point.
  - Depending on the result, the thyristor located between the measuring terminals of the first test or the second one needs to be removed.

**Remove faulty thyristor**

- If the thyristor is partly covered by a fuse, loosen the screws and move the fuse some centimeters up or down; fix the fuse.
- Remove the gate leads if possible.
- Loosen the mounting clamp ([see Figure 9-2](#)) at the top of the thyristor stack.

**Attention:** While loosen the mounting clamp the indicating spring must be pulled out a little, otherwise the spring will be damaged!

- Attach the disassembly tool at the faulty thyristor and prise open the upper and lower heat sinks ([see Figure 9-1](#)). The copper bars need not be loosened .
- Remove the thyristor.



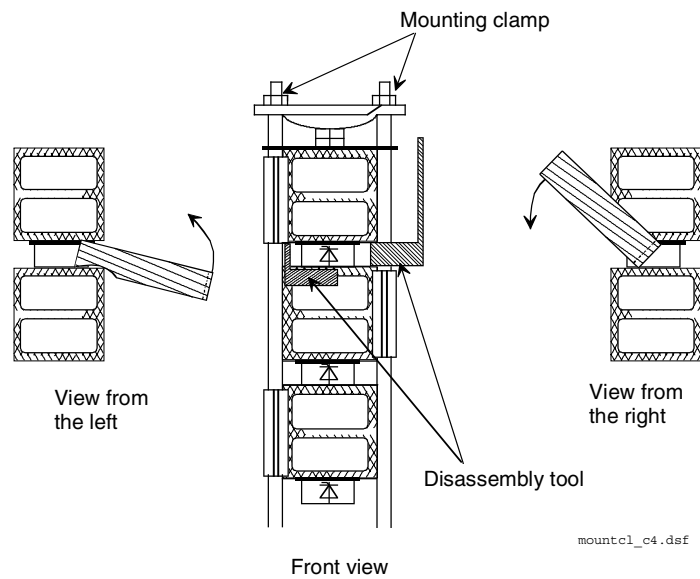

Figure 9-1 How to use the disassembly tool (at a left thyristor stack of a converter)

**Install new thyristor**

- Ensure that the new thyristor is of the correct type ([see Appendix A](#)). Keep the semiconductor and its surroundings clean. If necessary clean them with a piece of tissue paper moistened with solvent.
  - Note:** Do not touch the polished surfaces of the thyristor.
- Clean the polished surfaces of the semiconductor with a piece of tissue paper moistened with solvent. Dry all surfaces. Spread a **thin** layer of heat conducting paste on both sides of the thyristor, if necessary use a rubber spatula.
- Connect the gate leads if possible.
- Clean all parts with tissue paper moistened with solvent, which have had or will have contact with the thyristor or each other (lower / upper heat sink). Do not clean the surfaces of grease too thoroughly, because the aluminium surfaces will oxidise in a few seconds. Dry all surfaces.
- Push the thyristor until it snaps into its mounting clamp.
  - Note:** Be sure that the thyristor is installed in the right direction. Do not pinch or cut the gate leads or any other cable.
- Turn the thyristor so that the gate leads point in the right direction.

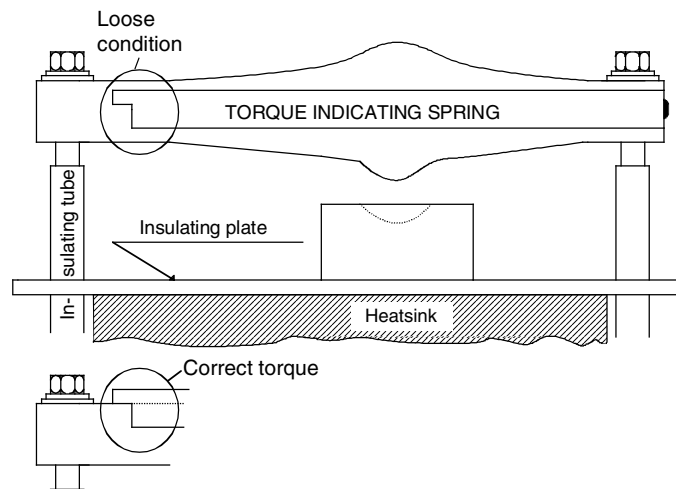

Figure 9-2 Aluminium spring with welded indicating spring

- Tighten the nuts of the mounting clamp by hand so that the clamp is in parallel with the contact surface of the heat sinks.  
**Note:** The indicating spring is a very sensitive instrument and must be handled with care.
- Tighten each nut in turn, half a turn at a time with the help of a ring spanner until the indicating spring clicks into position “correct torque” (see [Figure 9-2](#)). Do not tighten the screws any further.  
**Note:** The correct torque is indicated by means of the welded indicating spring.
- Perform an OHM test to make sure the thyristor is ok.
- Reconnect the DC / AC – busbars, branch fuses and all other dismantled parts.
- Perform an OHM test between U1, V1, W1 and C1, D1 to make sure the power part is ok.

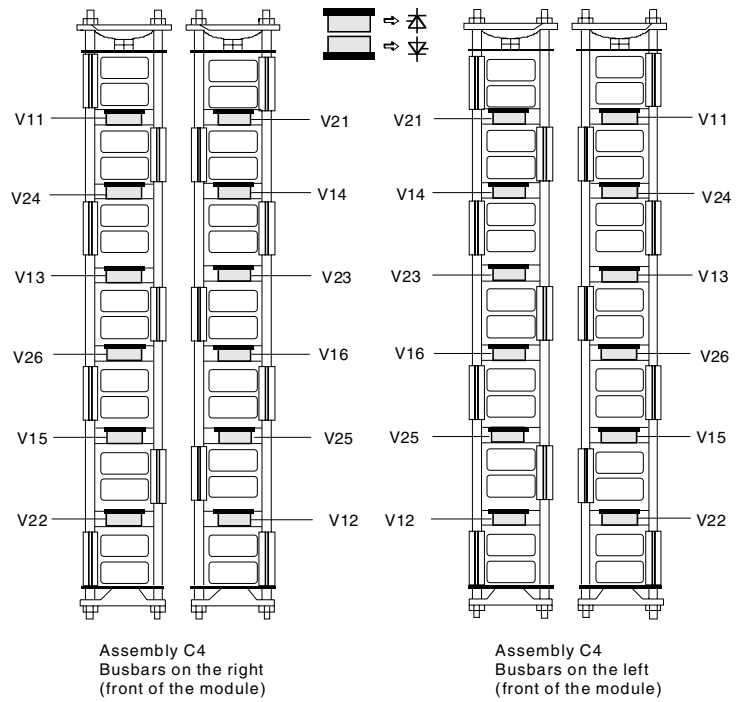

Figure 9-3 Location of thyristors in size C4 (4-Q bridge)

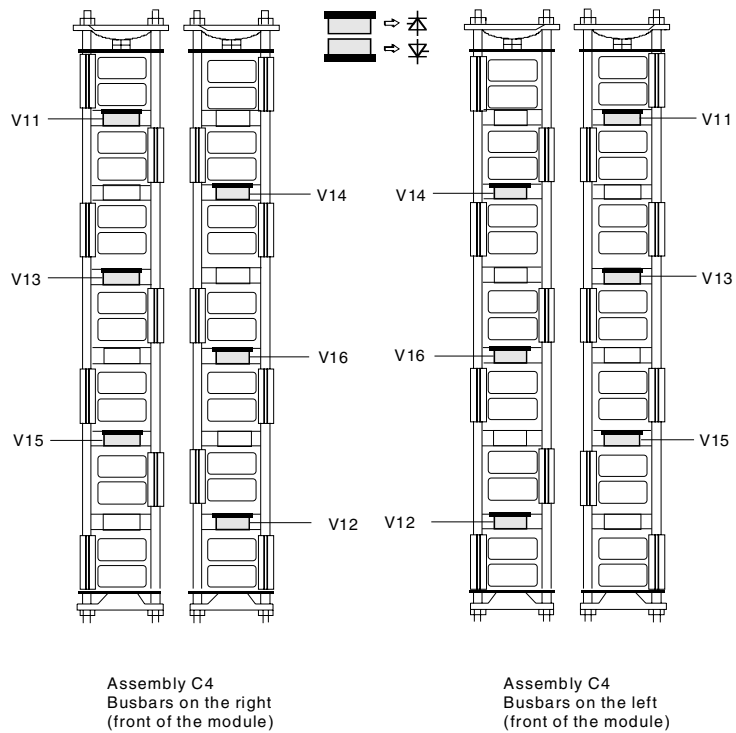

Figure 9-4 Location of thyristors in frame C4 (2-Q bridge)

*Chapter 9 - Exchange of Thyristors for Size C4*

### Compatibility of SDCS-PIN-2 boards

#### **Description of SDCS-PIN-20xB boards**

- In general the SDCS-PIN-20xB board has the same features as its predecessors (SDCS-PIN-20xA/20x or SDCS-PIN-2x).
- It is used for all DCS converters Module sizes C1 ( $\geq 100A$ ), C2 and C2b regardless of software version and function (armature or field supply).
- Converters equipped with the SDCS-PIN-20xB/20xA/20x boards can be identified by serial number. Every serial number is divided into two parts by a letter. With the SDCS-PIN-20xB/20xA/20x the serial number looks like 1234567B1234567. For the SDCS-PIN-2x an **A** is used.
- There are two types of SDCS-PIN-20xB boards:
  - SDCS-PIN-205B for converters with a incoming voltage of 400V/500V
  - SDCS-PIN-206B for converters with a incoming voltage of 600V
- The advantage of the SDCS-PIN-20xB/20xA/20x is the replacement of 6 other boards plus a small RC network. Thus the spare part handling becomes easier.

#### *Hardware coding*

On the SDCS-PIN-20xB resistors are used for hardware coding of the module, zero current detection and current scaling. In a new converter the resistors are already cut according to application. If the SDCS-PIN-20xB board is used as spare part all resistors are still uncut. The resistors have to be cut according to the table 'Settings of the SDCS-PIN-20xB board' as described in the manual *Technical Data*.

#### *Snubber circuit*

The incoming AC voltage is connected to the SDCS-PIN-20xB board via integrated fuses. The snubber circuit (RC network) is integrated as well and connected in parallel to the thyristors. This configuration leads to lower losses thus to a higher efficiency of the converter. Before larger converters had external RC networks. These are no longer needed.

Compatibility of SDCS-PIN-2 boards

**Compatibility of  
SDCS-PIN-20x  
boards**

The SDCS-PIN-20xB boards replaces SDCS-PIN-20xA and SDCS-PIN-20x boards, but not vice versa.

**Note:** SDCS-PIN-20xA replaces SDCS-PIN-20x, but not vice versa.

U <sub>AC</sub>	400V/500V				600V	
	I <sub>DC</sub>	100A-350A	405A-520A	700A	610A-1000A	100A-270A
Type	C1/C2	C2	C2	C2b	C1/C2	C2
<b>SDCS-PIN-205B</b>	✓	✓	✓	✓	-	-
<b>SDCS-PIN-206B</b>	-	-	-	-	✓	✓
SDCS-PIN-21	✓	-	-	-	-	-
SDCS-PIN-22	-	✓ ①	-	-	-	-
SDCS-PIN-23	-	-	-	-	✓	-
SDCS-PIN-24	-	-	-	-	-	✓ ①
SDCS-PIN-25	-	-	✓ ②	-	-	-
SDCS-PIN-205A/205	✓	✓	✓	-	-	-
SDCS-PIN-206A/206	-	-	-	-	✓	✓

✓: possible    -: not possible    ① together with SDCS-PIR-21    ② together with RC network

Table 10-1 Compatibility of SDCS-PIN-2xx boards

**Compatibility of  
SDCS-PIN-20x and  
SDCS-PIN-2x boards**

Converters  $100A \leq I_{DC} \leq 350A$  and U<sub>AC</sub>: 400V/500V

- SDCS-PIN-21 or
- SDCS-PIN-205B/205A/205 can be used as spare parts.

Converters  $405A \leq I_{DC} \leq 520A$  and U<sub>AC</sub>: 400V/500V

- SDCS-PIN-22 together with SDCS-PIR-21 or
- SDCS-PIN-205B/205A/205 can be used as spare parts.

Converters  $I_{DC} = 700A$  and U<sub>AC</sub>: 400V/500V (type C2)

- SDCS-PIN-25 together with RC network (possible only in converters with an **A** in their serial number) or
- SDCS-PIN-205B/205A/205 can be used as spare parts (possible in converters with an **A** or **B** in their serial number). In an A converter do **not** connect the RC network.

**Note:** In a B converter only SDCS-PIN205B/205A/205 boards are usable, because the RC network is missing.

Converters  $610A \leq I_{DC} \leq 1000A$  and U<sub>AC</sub>: 400V/500V (type C2b) only

- SDCS-PIN-205B can be used as spare part.

Converters  $100A \leq I_{DC} \leq 270A$  and U<sub>AC</sub>: 600V

- SDCS-PIN-23
- SDCS-PIN-206B/206A/206 can be used as spare parts.

Converters  $I_{DC} = 405A/450A$  and U<sub>AC</sub>: 600V

- SDCS-PIN-24 together with SDCS-PIR-21 or
- SDCS-PIN-206B/206A/206 can be used as spare parts.

**Note:** In addition to above mentioned limitations make sure that the resistors are cut properly according to the table 'Settings of the SDCS-PIN-20xB board' as described in the manual *Technical Data*. Especially when a board is reused!

**Change SDCS-PIN-2x boards**

The converter is equipped with a SDCD-PIN-21/22/23/24 board:

- Make sure, electrical and mechanical safety is obtained!
- Mark the cables connected to U1, V1, W1 and C1, D1. Mark the plugs connected to X22, X3 and X4.
- Disconnect all cables and plugs.
- Remove the SDCS-PIN-2x board.

**Note:** If the converter is equipped with a SDCS-PIR-21 there is no need to remove this board separately, because it is mounted on the SDCS-PIN-2x board.

- Make sure that the resistors on the new board are cut properly according to the table 'Settings of the SDCS-PIN-20xB board' as described in the manual *Technical Data*.
- Install the new SDCS-PIN-20xB board.

**Note:** SDCS-PIN-205B replaces SDCS-PIN21/23 and SDCS-PIN-206B replaces SDCS-PIN-22/24.

- Reconnect all cables and plugs.

The converter is equipped with a SDCD-PIN-25 board:

- Make sure, electrical and mechanical safety is obtained!
- Mark the cables connected to U1, V1, W1 and C1, D1. Mark the plugs connected to X22, X3 and X4.
- Disconnect all cables and plugs.
- Remove the SDCS-PIN-25 board.

**Note:** The additional RC network is not needed anymore. Due to safety reasons remove the cables marked U1 – C14, V1 – C16, W1 – C12, C1 – R15 and D1 – R12.

- Make sure that the resistors on the new board are cut properly according to the table 'Settings of the SDCS-PIN-205B board' as described in the manual *Technical Data*.
- Install the new SDCS-PIN-205B board.

**Note:** SDCS-PIN-205B replaces SDCS-PIN25.

- Reconnect all cables and plugs.

**Compatibility of thyristor modules for DCSxxx-0200 and DCSxxx-0250**

- Types concerned:** DCS500B and DCS600
- Actual status** All converter types with rated current 200A and 250A are now equipped with thyristor modules type MCC 95-16io1B.
- Hardware:** The thyristor module was changed from: SKKT 106/16 E (DCA0011931P0001) to MCC 95-16io1B (3ADC340012P0002)
- Subject:** The two types of thyristor modules are **not** compatible. The connectors for gate (**G2**) and cathode (**K2**) are exchanged. See also following drawing:

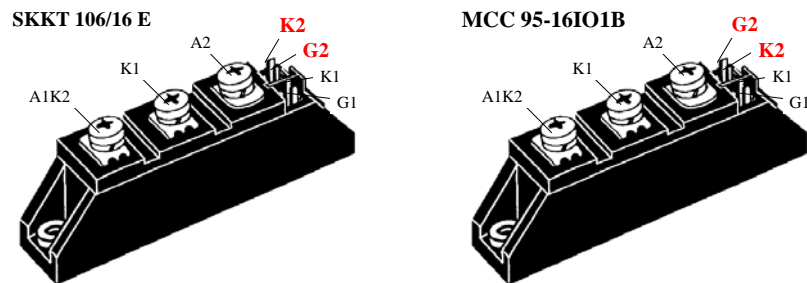

**Attention:** The connectors of the new firing pulse cable harness fit on the old thyristor module, but the leads (G2 and K2) for thyristor 2 are exchanged. There is no change for thyristor 1. The wire for the gate is yellow. The one for the cathode is red.

Spare parts:  
For the new converter modules with type code  
DCSxxx-xxxx-00-0000000-000000030  
use thyristor modules MCC 95-16io1B.

For the old converter modules with type code  
DCSxxx-xxxx-00-0000000-000000040 or  
DCSxxx-xxxx-00-0000000-0000000  
use thyristor modules SKKT 106/16E.

**Time schedule:** MCC 95-16io1B have been used since:  
DCS500B / DCS600: 14.10.2003 with serial number  
001941B3406813

**Compatibility:** The technical data of new converter modules are the same.



## **DC-Motor neutral zone adjustment**

**Types concerned** DC-Motors

**Summary** Procedure to adjust the neutral zone of a DC-motor

**General**

- Loosen the bolts holding the brush bridge.
- Connect a scope or a voltmeter between two adjacent brush-holder assemblies (holders with different polarity).
- Set the scaling on the scope or voltmeter to mV AC.
- Disconnect the excitation cables and connect 110 – 240 VAC between F+ and F- (a normal extension cord is sufficient).
- Start moving the brush bridge slowly in one direction and watch the scope or voltmeter. If the voltage is increasing move the brush bridge in the other direction.
- Try to get the voltage down to less than 50mV AC. The less the better.
- When this is achieved, start tightening the brush bridge bolts and watch the voltage. Sometimes you have to do a little offset to compensate for movements during tightening.
- Finally, mark the correct neutral zone position in case the motor will be taken apart in the future.

**How to remove the converter fan in a frame A6**

1. Remove the three screws at the top of the fan.
2. Disconnect the cables.
3. Lift the fan up and pull it out.



Figure 10-1 Converter fan in frame A6

**How to remove the converter fan in a frame A7**

1. Remove the three screws at the bottom of the fan.
2. Disconnect the cables.
3. Pull the fan out.

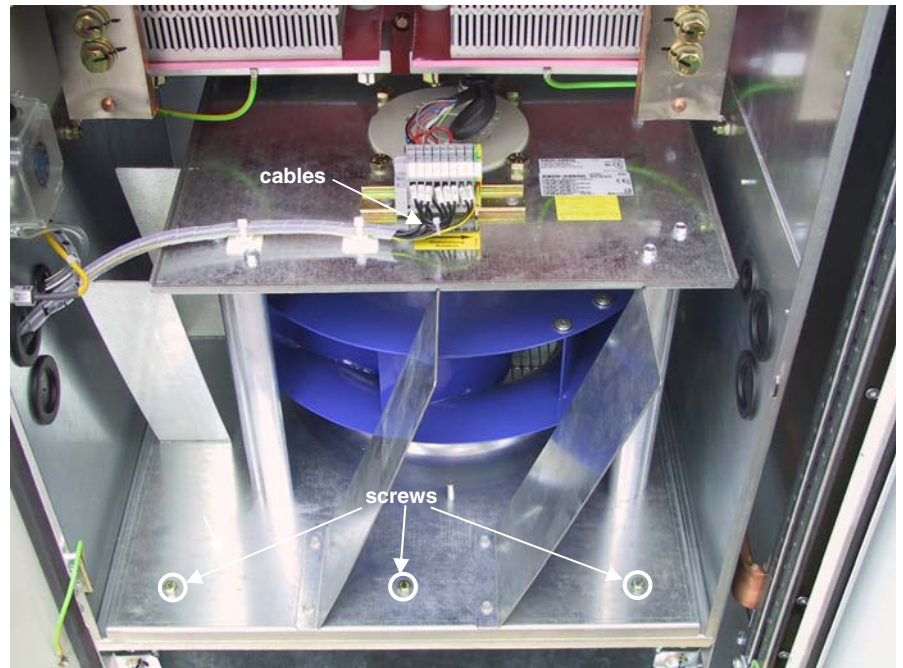

Figure 10-2 Converter fan in frame A7

## **SDCS-CON-x Firmware download instructions for Windows 2000 and NT 4.0**

### **Hardware Configuration**

#### *Firmware download Kit*

The Firmware download kit (3ADT 220106 R0001) handles the SDCS-CON-x firmware download process for DCS 500B and DCS 600 MultiDrive converters. It consists of an interface RS232 to RS485 and a bus cable (same as for panel connection).

**Note:** SDCS-CON-x resembles SDCS-CON-2 and higher.



*Figure 10 - 3 Firmware download kit*

#### *NPCU-02*

The NPCU-02 is a RS232 to RS485 interface **without** any galvanic isolation.

#### *Bus cable*

The bus cable (DCA 0021499 R0001) connects the interface with the DCS converter.

Installation

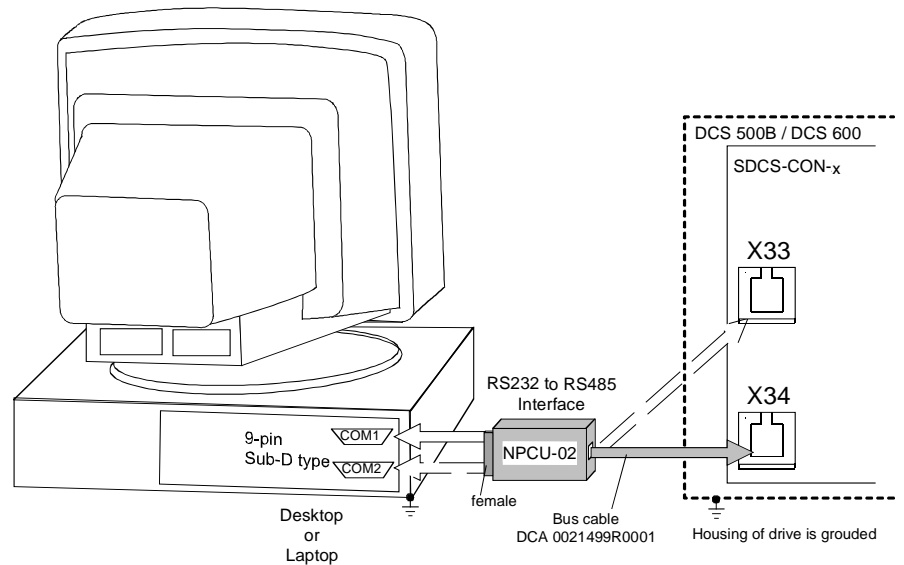

Figure 10 - 4 Connection of the interface between PC and the converter

**Software Configuration**

*PC Operating Systems*

The download kit supports the following PC operating systems:  
Windows 2000 and NT 4.0.

*Drive Software Versions*

The download kit supports the following Drive software versions:  
**21.2xx** DCS 500B (with SDCS-CON-2 board or higher)  
**15.2xx** DCS 600 MultiDrive (with SDCS-CON-2 board or higher)

*Programs / Files*

**HyperTerminal**

HyperTerminal Private Edition under Windows 2000 or HyperTerminal under Windows NT 4.0

distributed from ABB:

**CON2 download.ht**

INIT-file for HyperTerminal Private Edition or HyperTerminal: Download of the relevant version from the ABB LotusNotes database.

**DC21X2yy.ROM**

DCS 500B firmware and boot software: Download of the relevant version from the ABB LotusNotes database.

**DC15X2yy.ROM**

DCS 600 firmware and boot software: Download of the relevant version from the ABB LotusNotes database.

**Firmware download  
with Windows 2000**

*Recommendation*

It is strongly recommended:

- ❖ To use the ABB bus cable (DCA 0021499R 0001).
- ❖ To disconnect the laptop from mains supply during download.
- ❖ **The drive has to be grounded.**
- ❖ To switch off all other drives beside the destined unit (disturbances possible).

to provide save download transmission.

**HyperTerminal Private Edition**

Under Windows 2000 the HyperTerminal takes a very long time to download the firmware. For a faster download an updated version of the HyperTerminal, called "HyperTerminal Private Edition" (HTPE), is needed. Download it from:

[www.hilgraeve.com/hpte/download.html](http://www.hilgraeve.com/hpte/download.html)

**Attention:** The installation of the HyperTerminal Private Edition will delete all default Windows 2000 HyperTerminals!

Double-click on the downloaded file to start the installation:  
Choose: HyperTerminal Private Edition

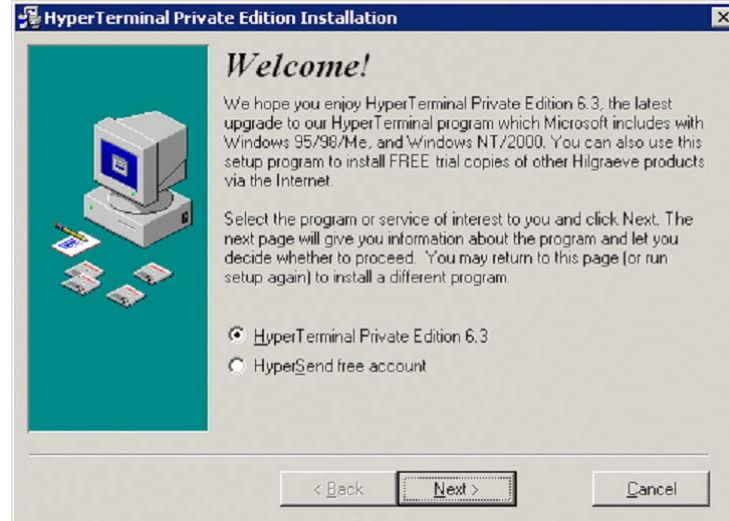

Choose: Yes

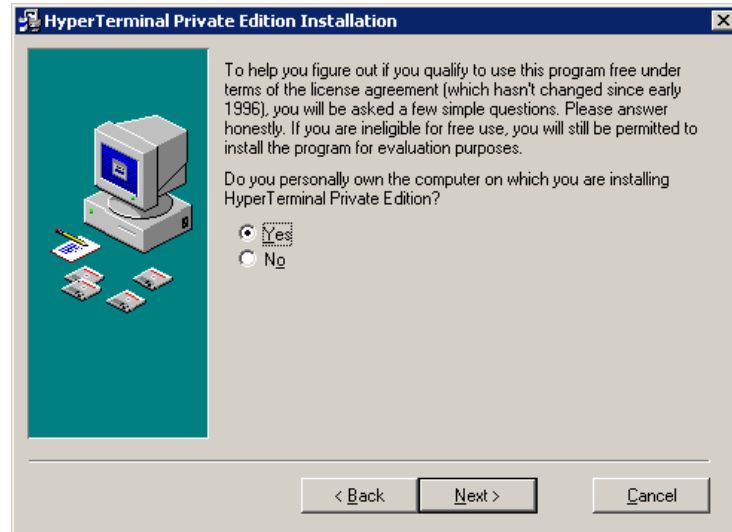

Choose: Install HyperTerminal to its default location

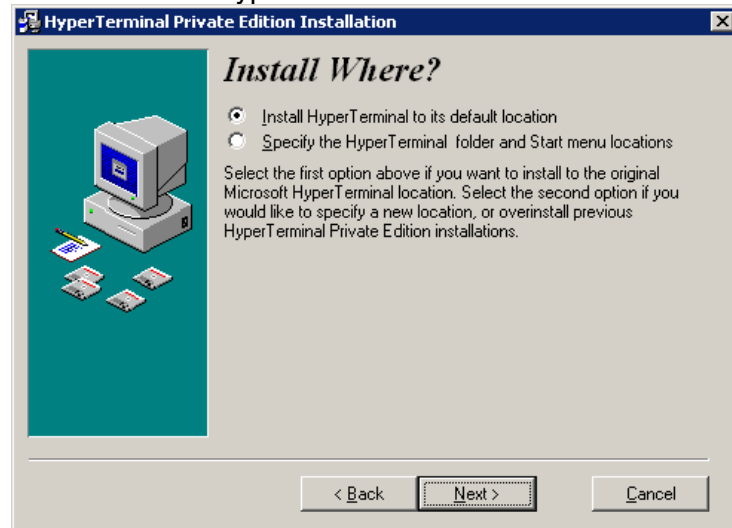

The program will be installed into the directory:

C:\Program Files\Windows NT\HyperTerminal

The executable will be found under:

Start\Programs\HyperTerminal Private Edition

To finish installation press proceed.

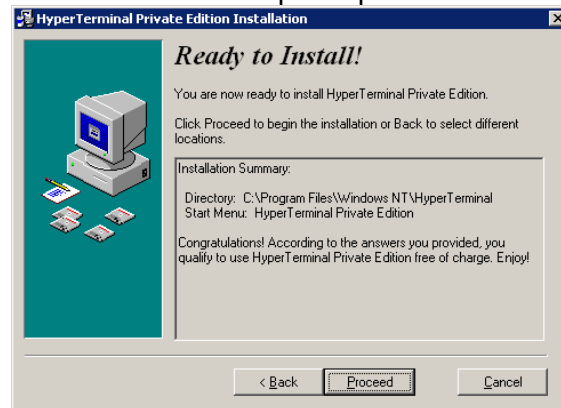

*Preparation*

- Switch off auxiliary supply voltage of SDCS-POW-1.
-  Disconnect and remove SDCS-AMC x board (only DCS 600).
- Disconnect any other equipment from X33 and X34.
- Connect bus cable from NPCU-02 to X33 or X34 at DCS converter.
- Connect the interface NPCU-02 to COM1 at the PC.
- Set Jumper S2 on SDCS-CON-x from position 7-8 or 3-4 to 5-6.
- Copy the files distributed from ABB ([see Software configuration](#)) into designated paths e.g.  
C:\Program Files\Windows NT\HyperTerminal and  
C:\...\DCSx00
- Start HyperTerminal Private Edition by double-click on CON2 download.ht.

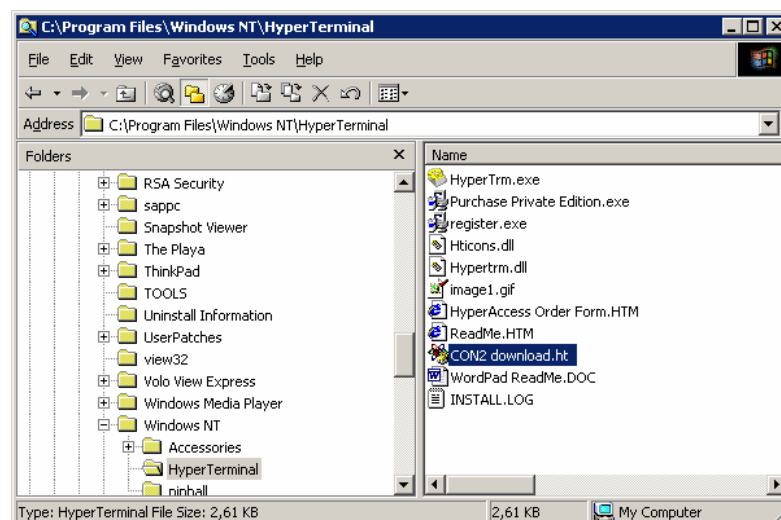

This setup file configures HyperTerminal Private Edition to communicate with the SDCS-CON-x board.



In case the setup file cannot be used (e.g. usage of COM2) the HyperTerminal Private Edition has to be started by double click on HyperTrm.exe.

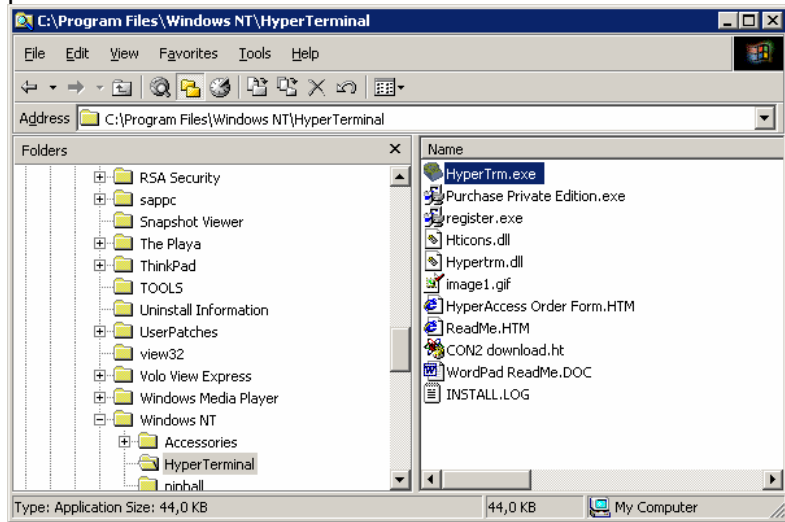

The setting can be checked and set via menu item **FILE/PROPERTIES** and

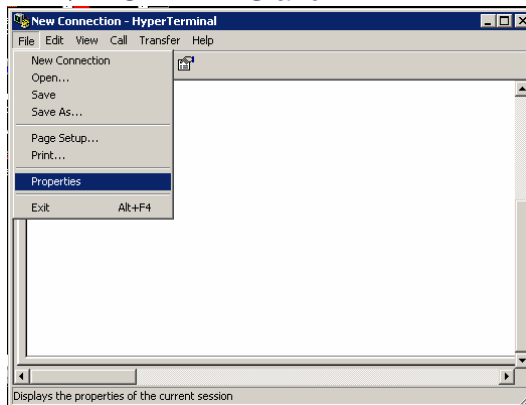

### CONFIGURE.

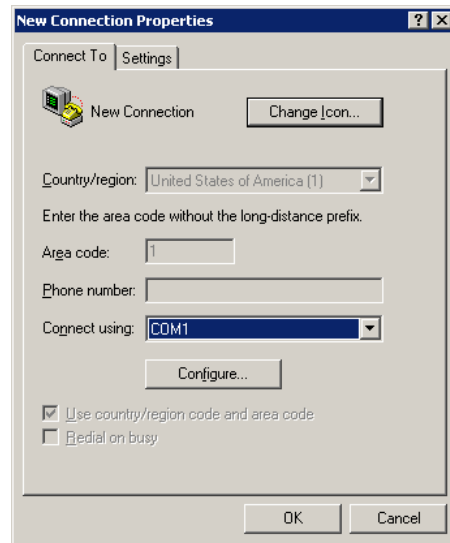

The properties for COM1 are shown below

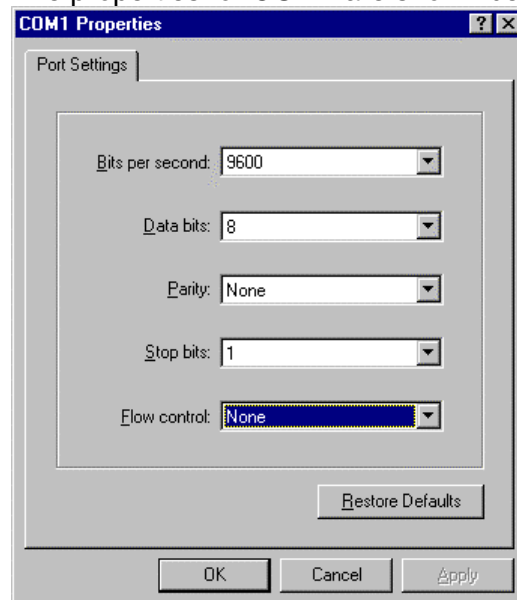

- Switch on auxiliary supply voltage of SDCS-POW-1
- The LED-display on the SDCS-CON-x shows a small **u**
- The terminal program detects communication

*HyperTerminal  
Private Edition*

Active communication is shown by the \*

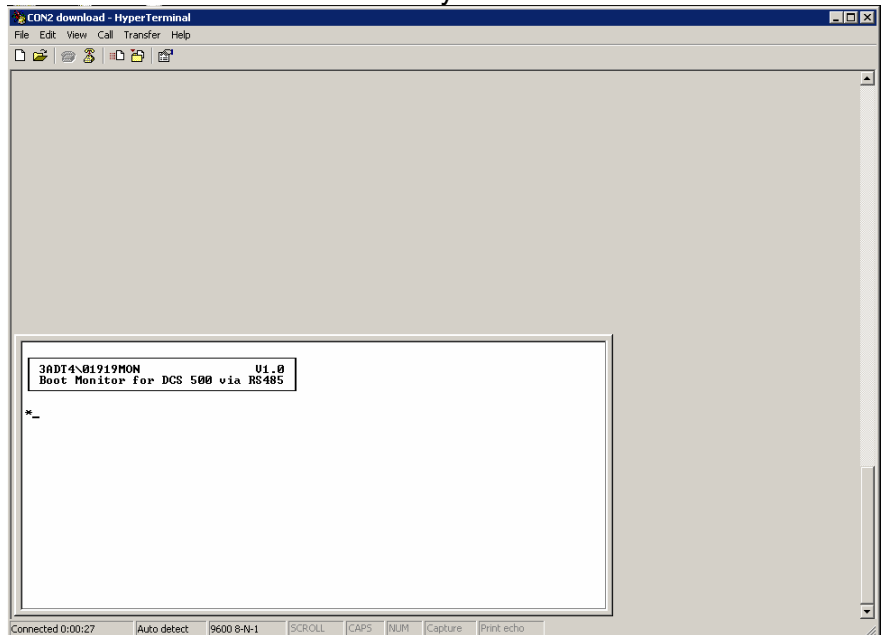

**Note:**

Syntax error indicates EMI (Electromagnetic interference) in the installation.

- check grounding
- switch off all other electronic equipment
- close and re-open HyperTerminal Private Edition

*Flash Erase*

- Type **Is** (+ Return).

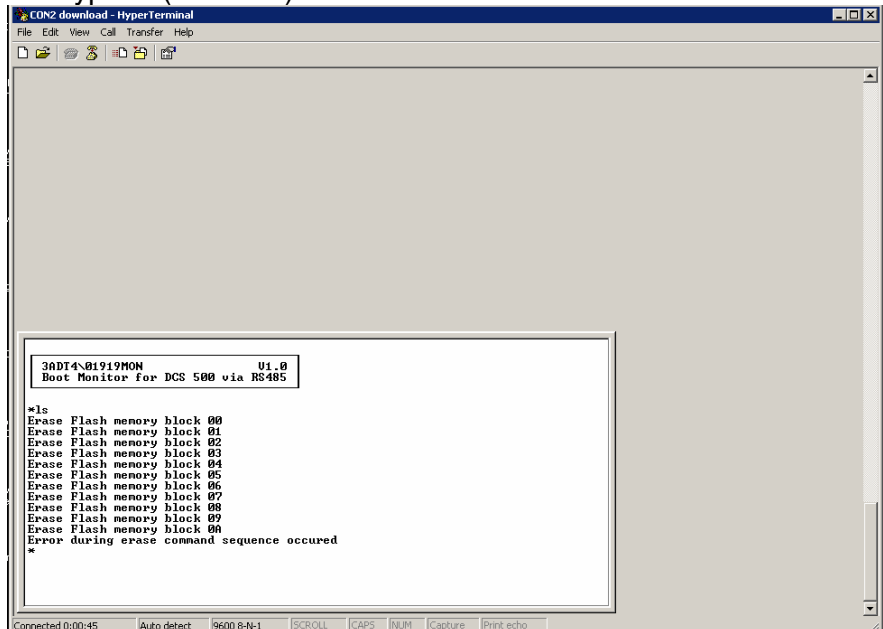

Flash Program

- Type **rp** (+ Return).
- Terminal program shows a small **rp**
- Open menu item TRANSFERS / SEND TEXT FILE... and select the suitable firmware

**Attention:** Use **DC21A2yy.rom** with **DCS 500B** and **DC15A2yy.rom** with **DCS 600**.

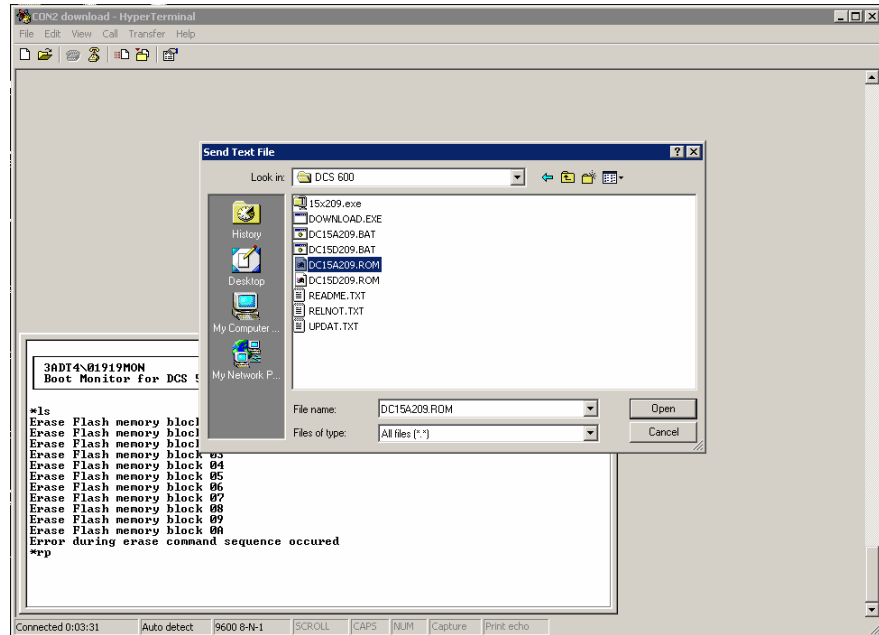

**Note:**

Additional information about the selection see *Update.txt* or Lotus *Notes database*.

After clicking OPEN the download starts immediately and SDCS-CON-x LED-display shows a small **r**.

*DCS 500B download lasts about 20 minutes.*

*DCS 600 download lasts about 5 minutes.*

After the download is finished the display shows a small **u** again and the terminal program gives the message **Program command successful completed.**

```

3ADT4\81919MON      U1.8
Boot Monitor for DCS 500 via RS485

*!s
Erase Flash memory block 00
Erase Flash memory block 01
Erase Flash memory block 02
Erase Flash memory block 03
Erase Flash memory block 04
Erase Flash memory block 05
Erase Flash memory block 06
Erase Flash memory block 07
Erase Flash memory block 08
Erase Flash memory block 09
Erase Flash memory block 00
Error during erase command sequence occurred
**p
Program command successfully completed
*_

```

- Switch off auxiliary supply (SDCS-POW-1).
- Set jumper S2 5-6 back to position 3-4 (or 7-8 if two jumpers are present).
-  Assemble the SDCS-AMC x board (only DCS 600). Take care on the plastic washer of the screw near CH0.

The download of the SDCS-CON-x is finished now.

The firmware version can be checked with  
 signal **112.18** for DCS 500B and  
 signal **4.11** for DCS 600.

**Firmware download  
with Windows NT 4.0**

*Recommendation*

It is strongly recommended:

- ❖ To use the ABB bus cable (DCA 0021499 R0001).
- ❖ To disconnect the laptop from mains supply during download.
- ❖ **The drive has to be grounded.**
- ❖ To switch off all other drives beside the destined unit (disturbances possible).

to provide save download transmission

*Preparation*

- Switch off auxiliary supply voltage of SDCS-POW-1.

-  Disconnect and remove SDCS-AMC x board (only DCS 600).
- Disconnect any other equipment from X33 and X34.
- Connect bus cable from NPCU-02 to X33 or X34 at DCS converter.
- Connect the interface NPCU-02 to COM1 at the PC.
- Set Jumper S2 on SDCS-CON-x from position 7-8 or 3-4 to 5-6.
- Copy the files distributed from ABB ([see Software configuration](#)) into designated pathes e.g.  
C:\...\DCSx00
- Start HyperTerminal by double-click on CON2 download.ht.

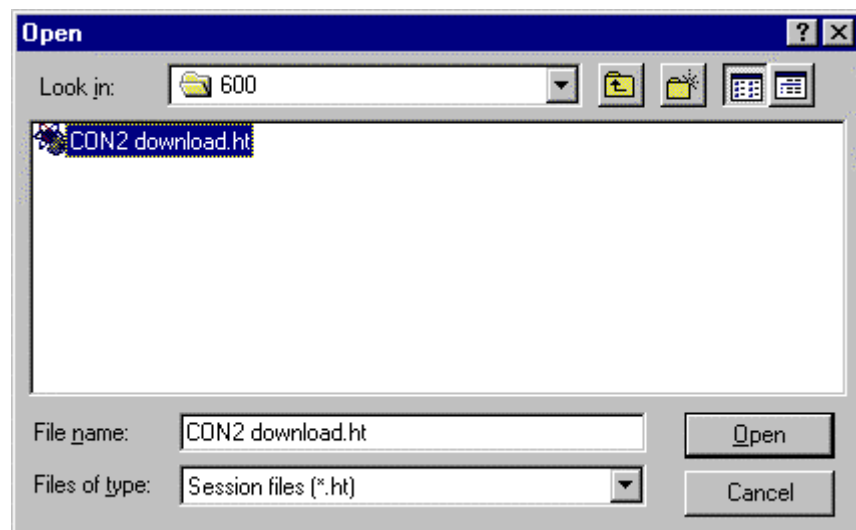

This setup file configures HyperTerminal to communicate with the SDCS-CON-x board.

The correct setting can be checked and set to the required settings (e.g. COMx connector) in the menu item: FILE/PROPERTIES/CONFIGURE

The properties for COM1 are shown below

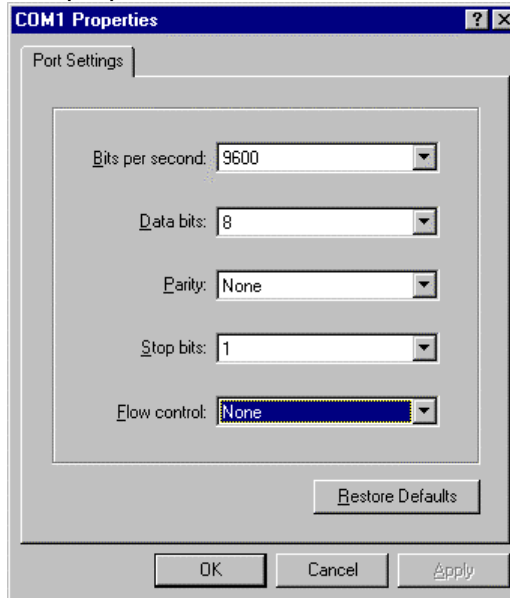

- Switch on auxiliary supply voltage of SDCS-POW-1
- The LED-display on the SDCS-CON-x shows a small u
- The terminal program detects communication

*HyperTerminal*

Active communication is shown by the \*

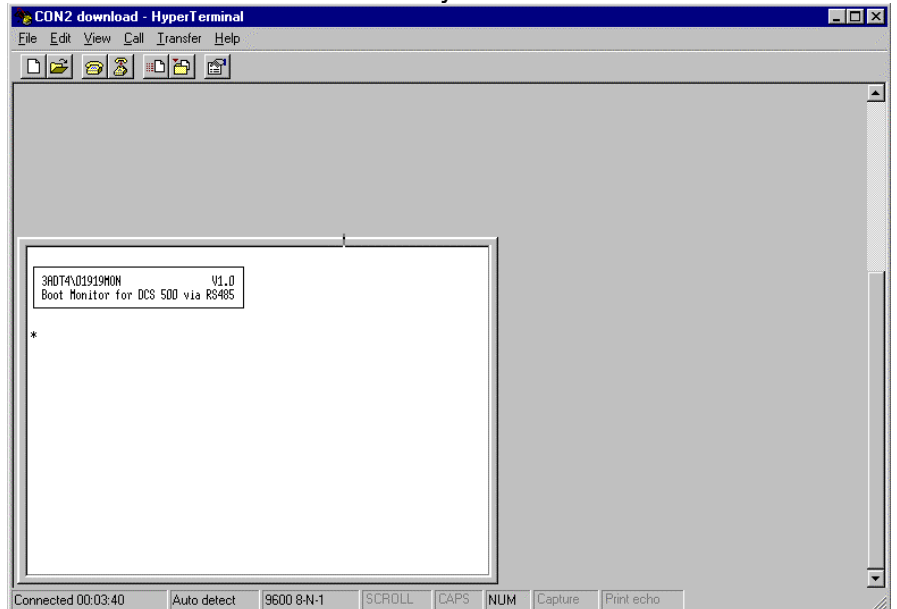

**Note:**

Syntax error indicates EMI (Electromagnetic interference) in the installation.

- check grounding
- switch off all other electronic equipment
- close and re-open HyperTerminal

*Flash Erase*

- Type **Is** (+ Return).

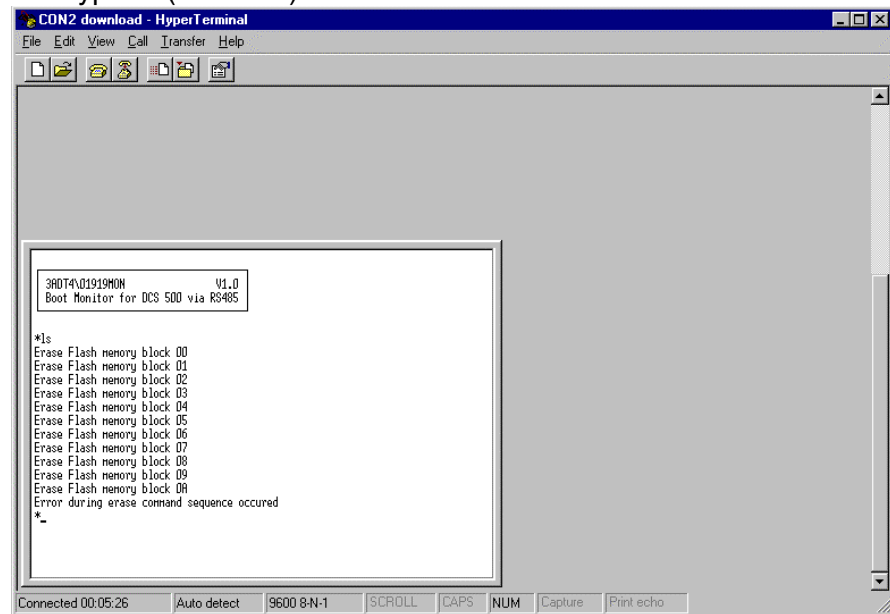

*Flash Program*

- Type **rp** (+ Return).
- Terminal program shows a small **rp**
- Open menu item TRANSFERS / SEND TEXT FILE... and select the suitable firmware

**Attention:** Use **DC21A2yy.rom** with **DCS 500B** and **DC15A2yy.rom** with **DCS 600**.

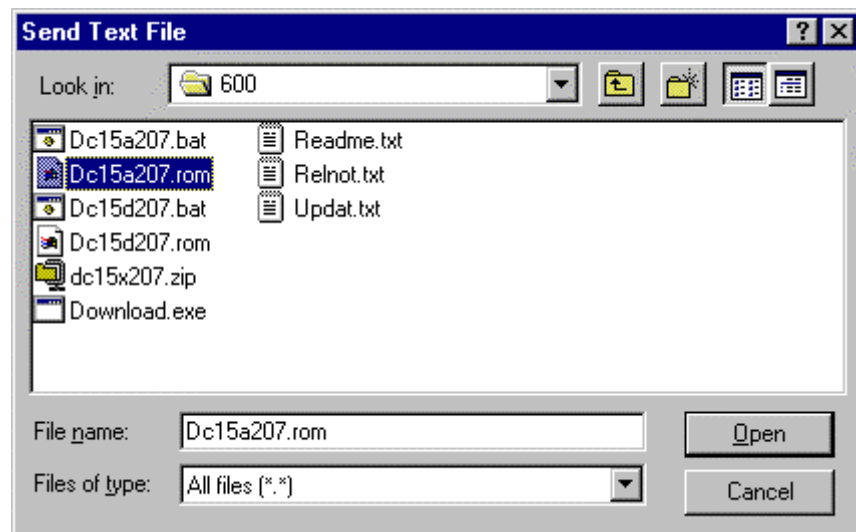



**Note:**

Additional information about the selection see *Update.txt* or Lotus *Notes database*.

After clicking OPEN the download starts immediately and SDCS-CON-x LED-display shows a small **r**.

*DCS 500B download lasts about 10 minutes.*

*DCS 600 download lasts about 5 minutes.*

After the download is finished the display shows a small **u** again and the terminal program gives the message **Program command successful completed**.

```

3ADT4\01919MON V1.0
Boot Monitor for DCS 500 via RS485

*!s
Erase Flash memory block 00
Erase Flash memory block 01
Erase Flash memory block 02
Erase Flash memory block 03
Erase Flash memory block 04
Erase Flash memory block 05
Erase Flash memory block 06
Erase Flash memory block 07
Erase Flash memory block 08
Erase Flash memory block 09
Erase Flash memory block 0A
Error during erase command sequence occurred
*rp
Program command successfully completed
*_

```

- Switch off auxiliary supply (SDCS-POW-1).
- Set jumper S2 5-6 back to position 3-4 (or 7-8 if two jumpers are present).
-  Assemble the SDCS-AMC x board (only DCS 600). Take care on the plastic washer of the screw near CH0.

The download of the SDCS-CON-x is finished now.

The firmware version can be checked with  
 signal **112.18** for DCS 500B and  
 signal **4.11** for DCS 600.

**DCS600 MultiDrive - How to download  
firmware on a SDCS-AMC-DC 2 board  
under Windows 2000**

*Types concerned* DCS600 MultiDrive

*Summary* Instruction how to download firmware on a SDCS-AMC-DC 2 board under **Windows 2000**. This download procedure is only valid for the basic firmware (AMC 15.6xx) from Lampertheim and not suitable for any application software.

**Download  
DCS600 Multi-  
Drive firmware**

**Attention:** Before downloading new firmware make a backup of the parameters!

1. Before download of the firmware the NtNisa drivers have to be installed (see NtNisa5x.zip or NtNisa5x.exe)
2. Unzip the SDCS-AMC-DC 2 firmware (file dc15x6yy.zip)
3. Connect the DCS600 MultiDrive with the PC (fibre optic cable from SDCS-AMC-DC 2 channel 3 to NDPA-02 / NDPC-12)
4. Switch on the DCS600 MultiDrive
5. Start firmware download by double click on:

L\_AMC\_DC.BAT

6. A DOS window will appear. Wait until the download is finished (DOS window will close again)
7. Check signal 4.2 for proper software version

### **DCS600 MultiDrive - How to download firmware on a SDCS-AMC-DC 2 board under Windows NT 4.0**

<i>Types concerned</i>	DCS600 MultiDrive
<i>Summary</i>	Installation of NtNisa drivers and instruction how to download firmware on a SDCS-AMC-DC 2 board under <b>Windows NT 4.0</b> . This download procedure is only valid for the basic firmware (AMC 15.6xx) from Lamperteim and not suitable for any application software.
<b>Download firmware with PCMCIA card (notebook or desktop)</b>	In order to use the loading package under Windows NT, install DriveWindow version 1.xx first. Afterwards the NT I/O handling has to be released.
<i>Installation of NtNisa drivers</i>	The first step is to find the used I/O addresses (280h - 340h) for the PCMCIA card (NDPA-02). The second is to reconfigure the I/O handling of NT. <b>Note:</b> If You already done so go directly to: <a href="#">Download DCS600 MultiDrive firmware!</a>

Following programs and files are required (Put them all in the directory where the unzipped load package is located. All files are already available in the firmware load package dc15x620 or higher):

ntnisa.exe	(to release the I/O control for DOS - programs)
nisareg.exe	(to set the I/O base address and make the pcmcia.inf file)
nisadump.exe	(to monitor the I/O addresses)
ntvddb.dll	

The DOS prompt has to be set to full screen. To do that You have to right click the DOS prompt icon (**Attention:** the DOS prompt icon has to be on the desktop of your PC). Go to properties, options and set display options to full screen.

To continue You have to be an ADMINISTRATOR on Your own PC!!!

*Configure PC*

1. Install DriveWindow 1.xx
2. Shut down NT, switch off the PC and remove the PCMCIA card if present
3. Switch the PC on, start NT, open the DOS prompt and go to the directory which contains nisadump.exe
4. Execute nisadump.exe (type: nisadump.exe↵). In the result screen FF means a free address. This information is saved in the file nisadump.txt
5. Rename nisadump.txt or write down the results
6. Shut down NT, switch off the PC and insert the PCMCIA card
7. Switch the PC on, start NT, open the DOS prompt and go to the directory which contains nisadump.exe
8. Execute nisadump.exe and compare the new nisadump.txt with the renamed one. The base I/O address of the PCMCIA card is the first address which data's have changed from FF to xx (usually 320)
9. Now execute nisareg.exe (type: nisareg␣<base I/O address>↵ in the DOS prompt; ␣ = space; <base I/O address> = 280 to 340 use the one you discovered in step 7) to set the base I/O address for the PCMCIA card. This creates the file pcmcia.inf
10. Copy the file pcmcia.inf into the root directory C:\.
11. In the DOS prompt go to the directory which contains ntnisa.exe
12. Execute ntnisa.exe (type: ntnisa.exe↵) in order to release the I/O control

**Download  
DCS600 Multi-  
Drive firmware**

**Attention:** Before downloading new firmware make a backup of the parameters!

1. Connect the DCS600 MultiDrive with the PC (fibre optic cable from SDCS-AMC-DC 2 channel 3 to NDPA-02 / NDPC-12)
2. Switch on the DCS600 MultiDrive
3. In the DOS prompt (full window!!) go to the root directory C:\ and type in CAPITAL letters (␣ = space):

SET␣ABBDDCS=PCMCIA

4. Now You are ready to download the DCS600 MultiDrive firmware
5. In the DOS prompt, go to the directory with the DCS600 MultiDrive firmware load files and type:

L\_AMC\_DC

6. Check signal 4.2 for proper software version

### **DCS600 MultiDrive - How to download parameter files on a SDCS-AMC-DC x board**

*Types concerned* DCS600 MultiDrive  
*Summary* Procedure how to download parameter files on a SDCS-AMC-DC x.

#### **Reload DCS600 MultiDrive parameters**

**Note:** This procedure should be used for new or newly loaded SDCS-AMC-DC x boards. An actual parameter set of all drives should be always available. If this is not the case, please create actual parameter sets by means of DriveWindow and save them as \*.DWP files. For DCS 600 MultiDrive a backup is not necessary, because the firmware is the same for all sizes and the autotuning results are saved as parameters.

1. Install and reconnect the new or newly loaded SDCS-AMC-DC x board in the DCS600 MultiDrive.
2. If a DriveWindow network is existing do **not** connect the DCS600 MultiDrive with the network. When using a new or newly loaded board parameter 70.15 (CH3 NODE ADDR) is set to 1 by default. This leads to a conflict in case another drive in the network owns node number 1.
3. Connect the DCS600 MultiDrive with the new or newly loaded SDCS-AMC-DC x board directly with DriveWindow.
4. Download the actual parameter set.  
**Note:** Group 99 will **not** be downloaded and has to be set by hand.
5. To activate parameters 70.15 (CH3 NODE ADDR) and 97.01 (DEVICE NAME) deenergise and energize the DCS600 MultiDrive.
6. Check the downloaded parameters with the DriveWindow compare function.
7. As soon as parameter 70.15 is valid it is possible to connect the DCS600 MultiDrive again with the DriveWindow network.
8. Set parameters in group 99 back to desired values.  
**Note:** User macros have to be created manually by means of parameters 95.11 (APPLICATION MACRO) and 99.09 (APPLIC RESTORE).



# Chapter 11 - Preventive Maintenance

---

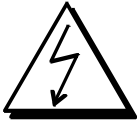

**WARNING!** Before performing any maintenance the chapter 'Safety Instructions' at the beginning of this manual must be followed. Negligence of these instructions can cause injury or death.

---

## **Recommended regular maintenance**

The DCS requires very little maintenance if installed in an appropriate environment. An annual check for dust accumulation and corrosion inside the module / cabinet is recommended.

### **Air Filters**

When air filters are used, the filters should be checked regularly depending on environmental conditions. Clogged up filters prevent the proper cooling of the drive.

Wash dirty filters with water (60°C) and detergent.

### **Cooling air pressure switch in converter modules type A6/A7/C4**

The cooling air pressure switch must be checked regularly.

The following actions have to take place:

- Make sure electrical safety is performed.
- Open the module's door and hold it in position to prevent any movement.
- Repeat it with the cabinet's door.
- Switch on the drive and try to turn the motor.
- The air pressure switch is ok when the converter is switched off by error "F50 NO C FAN"; crosscheck this result with the module's door closed.

### **Fan**

The lifetime of the cooling fan is about 20.000 to 40.000 hours depending on the converter type. The actual lifetime depends on the usage of the DCS and the ambient temperature.

Fan failure can be predicted by means of increasing noise from its bearings and a gradual rise of the heatsink temperature. If the DCS operates in a critical part of the process it is recommended to replace the fan once the above mentioned symptoms appear.

### **Heatsink**

The DCS will run into overtemperature faults if the heatsinks are not clean. In an appropriate environment the heatsinks should be checked and cleaned annually.

Use compressed air to remove the dust from the heatsinks (the air flow must be from bottom to top). Fan rotation caused by the compressed air must be stopped in order to prevent damage.

Additionally use a vacuum cleaner to clean the dust from the air inlet and outlet.

**Internal high current connections in converters type A7/C4**

The thyristors together with the heatsinks are stacked. Every single thyristor is connected to the DC+ and DC- busbars via flexible copper busbars. These busbars consist of 10 layers of preshaped sheet copper. This construction is able to compensate for small changes in length caused by temperature rise when current is flowing. The screw fixings between heatsink and flexible copper busbar have to withstand different types of mechanical stress. Therefore each fixing needs to be checked for correct torque. This check should be done regularly, e.g. annually or together with all the other work to be done for preventive maintenance.

Actions:

- Make sure all supply voltages are switched off, most important the supply for the power part (armature), for the electronic power part (SDCS-POW-1), for the converter fan and for other auxiliaries!
- Open the cabinet's and module's door; if needed secure them.
- Set a latching torque spanner to 25 Nm (18 lb-ft); a 17 mm nut is needed too.
- Check the torque of the screws marked within *Figure 11-1* at the end of this chapter:
  - Apply the torque spanner to the screw and turn right until the right torque is indicated.
  - Don't loosen the screws by a left hand turn!
  - Put on a new marking, if appropriate.

**Relays and electrical connections**

Relays should be checked for proper function and all connections should be inspected and checked for tightness. Any signs of corrosion, especially at ground components, must be removed.



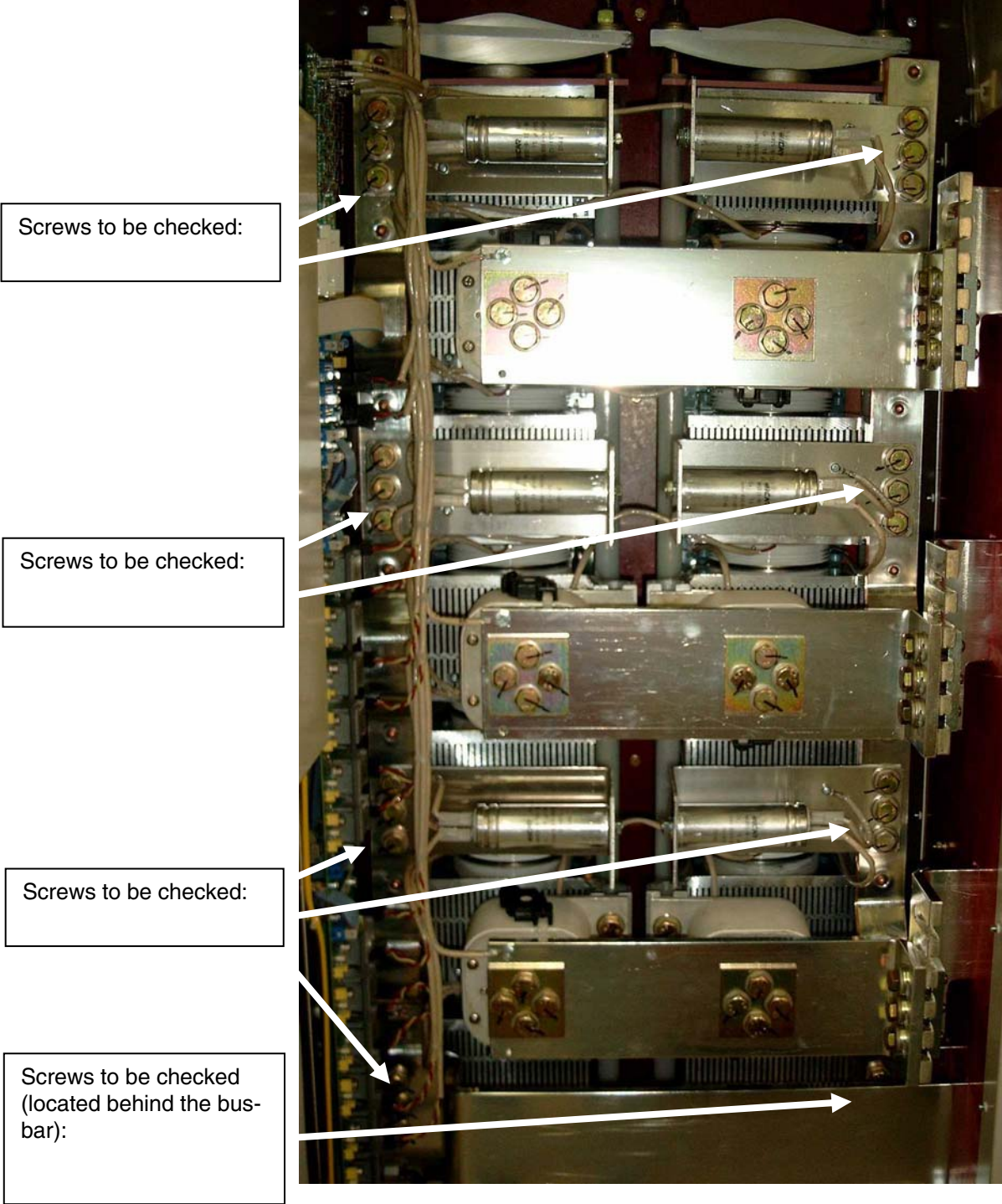

Figure 11-1: Power part of a converter module type A7/C4



## Appendix A - Spare Parts List

<b>2.00</b>	<b>PARTS FOR CONV. MODULES DCS500B; DCS600 and DCF500B/600 IN STANDARD VERS.</b>
-------------	--

<b>2.10 COMMON PARTS FOR CONV. DCS500B/DCF500Bxxxx-xx-21..(CON-2)</b>					
DESCRIPTION	QTY		CODE	TYPE/DATA	NOTES
Control board DCS500 B	1		3ADT220072R4	SDCS-CON - 2	with actual software 21.xxx
Power supply board	1		3ADT220090R3	SDCS-POW-1 COAT	

<b>2.20 COMMON PARTS FOR CONV. DCS600/DCF600xxxx-xx-15..MultiDrive; 18..Crane SW</b>					
DESCRIPTION	QTY		CODE	TYPE/DATA	NOTES
Control board +AMC-DC-2 Board	1*		3ADT220072R5	CON-2+AMC-DC-2	w.act. SW.15.xxx+AMC-DC-2 B.
Control board +AMC-Clas-2.	1*		3ADT220072R7	CON-2+AMC-Clas-2	w.act.SW.15.xxx+AMC-C-2 B.
Control b.+AMC-DC-2 Crane	1*		3ADT220072R22	CON-2-18+AMC-DC-2	Crane SW18+AMC-DC-2; incl. Fee
Control b.+AMC-Clas-2 Crane	1*		3ADT220072R20	CON-2-18+AMC-C-2	Crane SW18+AMC-C-2; incl. Fee
Power supply board	1		3ADT220090R3	SDCS-POW-1 COAT	

\*) Select only one Board

## Appendix A- Spare Parts List

2.30 COMMON PARTS FOR CONV. DCS500/DCS600 and DCF500/600					
DESCRIPTION	QTY	CODE	TYPE/DATA	NOTES	
*DI/DO connection board	1*	3BSE005176R1	SDCS-IOB-21	24V DC-48V DC; digital (A9)	
*DI/DO connection board	1*	3BSE005177R1	SDCS-IOB-22	115V AC ; digital (A9)	
*DI/DO connection board	1*	3BSE005178R1	SDCS-IOB-23	230V AC ; digital (A9)	
AI/AO connection board	1	3BSE004086R1	SDCS-IOB-3	analog (A 10)	
Communication Board	1	3ADT220059R1	SCDS-COM-5	separate	
AMC-Communic. Board DCS600	1	3ADT312700R1	AMC-DC-2 Board	without Software f. DCS600	
AMC-Communic. Board DCS600	1	3ADT312700R2	AMC-DC-Clas-2 B.	without Software f. DCS600	
Control Panel CDP312	1	3ADT220071R5	CDP312 Rev.F	For DCS500B & DCS600	
I/O Extension Board	1	3BSE005851R1	SDCS-IOE-1		
Adapt. Board /Analog Tacho	1	3ADT300600R1	PS 5311- SET		

\*) Select only one Board

2.40 PARTS FOR DCR REBUILD KITS, ( 12 Pulse etc. see item 2.41)					
DESCRIPTION	2Q	4Q	CODE	TYPE/DATA	NOTES
DCR-Kit contains:	2Q	4Q			
Cooling fan	1	1	DCA0017670P1	CN52B2	for DCR500B/600 Type
Pulse Interface Board	1	1	DCF1154914R1	SDCS-REB-1	DCR >= 1 Stage
Pulse Amplifier Board	1	1	DCF1192115R1	SDCS-REB-2	DCR >= 2 Stages
Pulse Distribution Board	1	1	3ADT309300R1	SDCS-REB-3	DCR >= 3 Stages
Power Supply for REB-2	2	2	DCE8920037P1	NPSM-01	230V/24V DC/ 2A >= 2 Stages
below listed SDCS- PIN-48 and PIN-51 are identical with A5/A7 and C4 Modules; A6 modules use SDCS-PIN-48 or SDCD-PIN-46-coat					
Pulstransformer Board	1	2	3BSE004939R2	SDCS-PIN-48	
Power interface board	1	1	3BSE004940R1	SDCS-PIN-51	for 400V up to 1000V AC
Current Transformer 2500/1A	2	2	3ADT751010P1	LT2032 2500/1A	T51/T52 for A5 and A6 Range
Current Transformer 4000/1A	2	2	3ADT751007P1	4000/1A	T51/T52 for A7/C4 Range

2.41 PARTS FOR 12 PULSE SYST.; SUPPLY > 800V-AC & HARD PAR. CONV. A7P					
DESCRIPTION	2Q	4Q	CODE	TYPE/DATA	NOTES
Current Measurement Aid	1	1	3ADT220090R22	SDCS-CMA-2	12 Pulse and Paralleling Converter
Insulation Monitor (10V)	1	1	DCA0019192P1	IRDH 265-4	mounted inside Cab.10-990kOhm
Insulation Monitor (10V)	1	1	3ADV050058P5	IRDH 365-4	Door mounted Vers.10- -990kOhm
Insulation Monitor (10V)	1	1	3ADV050058P1	IRDH 265-3	inside Cab.-EMBR; 2 - 200kOhm
Volt. Adapt. Board f. IRDH 6P.	1	1	DCA0019711P1	AGH 204 S	For IRDH >= 690V-AC 6Pulse
Volt. Adapt. Board f. IRDH 12P.	1	1	3ADV050058P2	AGH 150 W-4	For IRDH >= 690V-AC 12Pulse
DC-DC Transducer (Knick) A92	1	1	3ADN260004P1	8680 A1/A92	For U-AC > 800V & 12 Pulse ser.
High Volt. Transformer T 90	1	1	3ADT745047P1	T 90; 500-1200V-AC	For U-AC > 800V & 12 Pulse ser.
High Volt. Fuses for U >800V-AC	5	5	DCE8063614P1	CC 1500CP GRD 20	2 pcs. for A92; 3 pcs. for T90 ;
Paralleling Interface Board 1	1	1	3ADT220090R31	SDCS-PAR-1-coat	Paralleling Master Conv.
Paralleling Interface Board 2	1	1	3ADT220090R32	SDCS-PAR-2-coat	Paralleling Slave Conv.

2.50 2-PHASE FIELD EXCITERS					
DESCRIPTION	QTY	CODE	TYPE/DATA	NOTES	
Integrated uncontr. 6 A;FEX-1	1	DCA0012317R1	SDCS-FEX-1	Sep. compl. Unit; incl. Diode M.	
Integrated single 16 A;FEX-2A	1	DCA0012325R1	SDCS-FEX-2 A	Sep. compl. Unit; incl. Thyristor M.	
Control Board DCF503A0050	1	3ADT312400R2	SDCS-FEX-32A	Control Board f. DCF503A0050	
Thyristor/Diode Module 1Q 50A	2	DCA0003270P1	SKKH 57	for DCF503A0050	
Control Board DCF504A0050	1	3ADT312400R1	SDCS-FEX-31A	Control Board f.DCF504A0050	
Thyristor modules 4Q 50A	2	DCA0011132P1	SKKT 42	for DCF504A0050	
Ext. DCF503A0050; 1Q 50 A	1	3ADT209019R1	DCF503A0050	Complete unit DCF503A0050	
Ext. DCF504A0050; 4Q 50 A	1	3ADT209019R2	DCF504A0050	Complete unit DCF504A0050	
Ext. DCF503A0060; 1Q 60 A	1	3ADT209019R11	DCF503A0060	Complete unit DCF503A0060	
Ext. DCF504A0060; 4Q 60 A	1	3ADT209019R12	DCF504A0060	Complete unit DCF504A0060	
Addit. Fan for DCFxxxA0060	2	GHSN700002P1	AC220V 8556V	Fan M55/M56 f. DCFxxxA0060	

2.60 Parts for Three-Phase Fieldexc.; 25A ---520A; Overvolt.Protect. DCF506--					
DESCRIPTION	4 Q	CODE	TYPE/DATA	NOTES	
Control Board for DCF505/506 Units	1	3BSE006309R1	SDCS-FEP-1	(1400V) for DCF505/506	
Overvolt. Protect. for Motorfieldexc.	1	DCF1127101R1	DCF506-0140-51	3-Phase Fieldexc. 25A - 100A	
Overvolt. Protect. for Motorfieldexc.	1	DCF1127119R1	DCF506-0520-51	3-Phase Fieldexc. 200A - 520A	
Overvolt. Protect. for inductive Load	1	DCF1216235R1	DCF506-1200-51	3-Phase EMBR's 820-1200A	

<b>3.00 Coated Electr. Boards for DCS500B; DCS600; Fieldexc.; I/O Boards; DCR Kits &amp; Mod.</b>					
<b>3.10 Coated Boards for DCS500B (see item 2.10)</b>					
DESCRIPTION	QTY		CODE	TYPE/DATA	NOTES
Control board DCS500 B	1		3ADT220072R12	SDCS-CON - 2-21-coat	with actual software21.xxx
Power supply board	1		3ADT220090R3	SDCS-POW-1 COAT	
<b>3.20 Coated Boards for DCS600/DCF600 (see item 2.20)</b>					
Control board +AMC-DC-2 Board	1*		3ADT220072R9	CON-2+AMC-DC-2 coat	w.act. SW.15.xxx+AMC-DC-2 B.
Control board +AMC-Clas2.	1*		3ADT220072R11	CON-2+AMC-Cl.-2 coat	w.act.SW.15.xxx+AMC-Cl.-2 B.
Control b.+AMC-DC-2 Crane	1*		3ADT220072R40	CON-2-18+AMC-DC-2-coat	Crane SW18+AMC-DC-2; incl. Fee
Control b.+AMC-Clas-2 Crane	1*		3ADT220072R41	CON-2-18+AMC-C-2-coat	Crane SW18+AMC-C-2; incl. Fee
Power supply board	1		3ADT220090R3	SDCS-POW-1 COAT	
<b>3.30 Coated Interface Boards ; Panels for DCS500B/DCS600 Modules/Cabinets</b>					
*)DI/DO connection board	1*		3ADT220090R14	SDCS-IOB-21-coat	24V DC-48V DC; digital (A9)
*)DI/DO connection board	1*		3ADT220090R13	SDCS-IOB-22-coat	115V AC ; digital (A9)
*)DI/DO connection board	1*		3ADT220090R23	SDCS-IOB-23-coat	230V AC ; digital (A9)
AI/AO connection board	1		3ADT220090R20	SDCS-IOB-3-coat	analog (A 10)
Communication Board	1		3ADT220090R26	SDCS-COM-5-coat	separate
I/O Extension Board	1		3ADT220090R25	SDCS-IOE-1-coat	
Adapt. Board /Analog Tacho	1		3ADT220090R29	PS 5311- coat	
<b>3.40 Coated Boards for DCR Rebuild Kits and 12 Pulse-Systems (see item 2.30)</b>					
Pulse Interface Board	1	1	3ADT220090R9	SDCS-REB-1-coat	Coated Board for DCR
Pulse Amplifier Board	1	1	3ADT220090R34	SDCS-REB-2-coat	Coated Board for DCR
Pulstransformer Board	1	2	3ADT220090R0043	SDCS-PIN-48-coat	
Power interface board	1	1	3ADT220090R6	SDCS-PIN-51-coat	for 400V up to 1000V AC
Current Measurement Aid	1	1	3ADT220090R22	SDCS-CMA-2-coat	12 Pulse and Paralleling Converter
<b>3.50 Coated Boards for 2-PHASE FIELD EXCITERS see item 2.50</b>					
Integrated single 16 A; FEX-2	1		3ADT220090R19	SDCS-FEX-2 A-coat	Sep. compl. Unit; coated Vers.
Control Board DCF503A0050	1		3ADT220090R37	SDCS-FEX-32A-coat	Coat. Contr. Board DCF503A..
Control Board DCF504A0050	1		3ADT220090R36	SDCS-FEX-31A-coat	Coat. Contr. Board DCF504A..
Ext. DCF503A-0050; 1Q 50 A	1		3ADT209019R0101	DCF503A0050-Coat	Complete unit DCF503A0050
Ext. DCF504A0050; 4Q 50 A	1		3ADT209019R0102	DCF504A0050-Coat	Complete unit DCF504A0050
<b>3.60 Coated Boards for 25A - 5200A Modules</b>					
Power interface board	1	1	3ADT220090R27	SDCS-PIN-11-coat	25A; 50A and 75A Mod.
Power interface board	1	1	3ADT220090R35	SDCS-PIN 205B-Coat	100A - 1000A/400/500V Mod.
Power interface board	1	1	3ADT220090R38	SDCS-PIN 206B-Coat	110A,270A and 450A/600V M.
Puls transformer board	1	2	3ADT220090R0043	SDCS-PIN-48-coat	900A - 5150A
Power interface board	1	1	3ADT220090R6	SDCS-PIN-51-coat	for 400V up to 1000V AC

\*) Select only one Board

## Appendix A- Spare Parts List

### Item 4.00 to 10.00 Module DCS500B / DCS600 Size C1 25A----140A

4.00 Common Parts for C1, C2 and C2b Modules from 25A ---1000A (Item 4.10 - 18.30)					
DESCRIPTION	2 Q	4 Q	CODE	TYPE/DATA	NOTES
Temperatur Sensor (R57)	1	1	DCA0012139P1	KTY 10-6 M4	(C1-C2b / 550mm cable)

Fuse F101; F102 and F103 on PIN205B and PIN206B see Modules from 100A till 1000A ; item 8.00 - 18.00

Module contains:					
4.10 25 A (400V-500V) CONVERTER					
DESCRIPTION	2 Q	4 Q	CODE	TYPE/DATA	NOTES
Thyristor modules	3	6	DCA0008018P1	SKKT27/16E *	
Power interface board	1	1	3ADT306100R1	SDCS-PIN-11	DCF501,502, DCF 601, 602 (1)
Semiconductor fuses	3	3	DCZ9838767P1	170M1564	
Cooling fan	1	1	DCA0017670P1	CN52B2	

(1) If used as a spare part for DCF... the resistors R113/R116/R119 must be removed. For further information see "Technical Data"

\* DCS500/DCS600 Thy. Modules SKKT 27 / 16E are not identical to Thy. Modules SKKT 27 B/16E used for DCS400 Converter Modules

Module contains:					
5.00 50 A (400V-500V) CONVERTER					
DESCRIPTION	2 Q	4 Q	CODE	TYPE/DATA	NOTES
Thyristor modules	3	6	DCA0011132P1	SKKT42/16E *	
Power interface board	1	1	3ADT306100R1	SDCS-PIN-11	DCF501,502, DCF 601, 602 (1)
Semiconductor fuses	3	3	DCZ9838791P1	170M1566	
Cooling fan	1	1	DCA0017670P1	CN52B2	

(1) If used as a spare part for DCF... the resistors R113/R116/R119 must be removed. For further information see "Technical Data"

\* DCS500/DCS600 Thy. Modules SKKT 42 / 16E are not identical to Thy. Modules SKKT 42 B/16E used for DCS400 Converter Modules

Module contains:					
6.00 50 A (600V) CONVERTER					
DESCRIPTION	2 Q	4 Q	CODE	TYPE/DATA	NOTES
Thyristor modules	3	6	DCA0011906P1	SKKT57/20E *	
Power interface board	1	1	3BSE005716R1	SDCS-PIN-12	
Semiconductor fuses	3	3	DCZ9838791P1	170M1566	changed Oct.2001
Cooling fan	1	1	DCA0017670P1	CN52B2	

\* DCS500/DCS600 Thy. Modules SKKT 57 / 16E are not identical to Thy. Modules SKKT 57 B/16E used for DCS400 Converter Modules

Module contains:					
7.00 75 A (400V-500V) CONVERTER					
DESCRIPTION	2 Q	4 Q	CODE	TYPE/DATA	NOTES
Thyristor modules	3	6	DCA0011914P1	SKKT57/16E *	
Power interface board	1	1	3ADT306100R1	SDCS-PIN-11	DCF501,502, DCF 601, 602 (1)
Semiconductor fuses	3	3	DCA0012686P1	170M1568	
Cooling fan	1	1	DCA0017670P1	CN52B2	

(1) If used as a spare part for DCF... the resistors R113/R116/R119 must be removed. For further information see "Technical Data"

\* DCS500/DCS600 Thy. Modules SKKT 57 / 16E are not identical to Thy. Modules SKKT 57 B/16E used for DCS400 Converter Modules

Module contains:					
8.00 100 A (400V-500V) CONVERTER					
DESCRIPTION	2 Q	4 Q	CODE	TYPE/DATA	NOTES
Thyristor modules	3	6	DCA0011931P1	SKKT 106/16E *	
Power interface board	1	1	3ADT312500R1	SDCS-PIN 205B	Repl. SDCS PIN-21 and PIN205
Fuse F101- F103 on PIN205B	3	3	3BSC770010R0101	KTK-R6A/660V	
Semiconductor fuses	3	3	DCA0012694P1	170M3815	
Cooling fan	1	1	DCA0012678P1	W2E143-AA09-25	

\* DCS500/DCS600 Thy. Modules SKKT 106 / 16E are not identical to Thy. Modules SKKT 106 B/16E used for DCS400 Converter Modules

Module contains:					
9.00 110 A (600V) CONVERTER					
DESCRIPTION	2 Q	4 Q	CODE	TYPE/DATA	NOTES
Thyristor modules	3	6	DCA0011922P1	SKKT72/20E	
Power interface board	1	1	3ADT312500R2	SDCS-PIN 206B	Repl. SDCS PIN-23 and PIN206
Fuse F101- F103 on PIN206B	3	3	3BSC770010R0101	KTK-R6A/660V	
Semiconductor fuses	3	3	DCA0012694P1	170M3815	
Cooling fan	1	1	DCA0012678P1	W2E143-AA09-25	

Module contains:					
10.00 140 A (400V-500V) CONVERTER					
DESCRIPTION	2 Q	4 Q	CODE	TYPE/DATA	NOTES
Thyristor modules	3	6	DCA0011931P1	SKKT 106/16E *	
Power interface board	1	1	3ADT312500R1	SDCS-PIN 205B	Repl. SDCS PIN-21 and PIN205
Fuse F101- F103 on PIN205B	3	3	3BSC770010R0101	KTK-R6A/660V	
Semiconductor fuses	3	3	DCA0012694P1	170M3815	
Cooling fan	1	1	DCA0012678P1	W2E143-AA09-25	

\* DCS500/DCS600 Thy. Modules SKKT 106 / 16E are not identical to Thy. Modules SKKT 106 B/16E used for DCS400 Converter Modules

Item 11.00 to 17.10 Mod. DCS500B / DCS600 Size C2 200A-- 520A

Module contains:		2Q	4Q		
<b>11.00 200 A (400V-500V) CONVERTER</b>					
DESCRIPTION	2 Q	4 Q	CODE	TYPE/DATA	NOTES
Thyr. mod.; Unit Produced after 15.10.2003	3	6	3ADC340012P2	MCC 95-16IO1B *	only for modules with type code e.g. DCSxxx-0200-x1-2100000-000000030
Thyr. Mod.;Unit Produced before 14.10.2003	3	6	DCA0011931P1	SKKT 106/16E **	only for modules with type code e.g. DCSx0x-0200-x1-2100000-000000040 (instead of a 4 a 0 could be used)
Power interface board	1	1	3ADT312500R1	<b>SDCS-PIN 205B</b>	Repl. SDCS PIN-21 and PIN205
Fuse F101- F103 on PIN205B	3	3	3BSC770010R0101	KTK-R6A/660V	
Semiconductor fuses	3	3	3ADC770024P9	170M3816	
Cooling fan	1	1	DCA0012171P1	W2E200-HH38-06	

\* Attention: Above listed Thyristor modules MCC95 or SKKT...are different at Gate Connection; Please check the Type Code at the Name plate

\*\* DCS500/DCS600 Thyr. Modules SKKT 106 / 16E are not identical to Thyr. Modules SKKT 106 B/16E used for DCS400 Converter Modules

Module contains:		2Q	4Q		
<b>12.00 250 A (400V-500V) CONVERTER</b>					
DESCRIPTION	2 Q	4 Q	CODE	TYPE/DATA	NOTES
Thyr. mod.; Unit Produced after 15.10.2003	3	6	3ADC340012P2	MCC 95-16IO1B *	only for modules with type code e.g. DCSx0x-0250-x1-2100000-000000030
Thyr. Mod.;Unit Produced before 14.10.2003	3	6	DCA0011931P1	SKKT 106/16E **	only for modules with type code e.g. DCSx0x-0250-x1-2100000-000000040 (instead of a 4 a 0 could be used)
Power interface board	1	1	3ADT312500R1	<b>SDCS-PIN 205B</b>	Repl. SDCS PIN-21 and PIN205
Fuse F101- F103 on PIN205B	3	3	3BSC770010R0101	KTK-R6A/660V	
Semiconductor fuses	3	3	3ADC770024P10	170M3817	
Cooling fan	1	1	DCA0012171P1	W2E200-HH38-06	

\* Attention: Above listed Thyristor modules MCC95 or SKKT...are different at Gate Connection; Please check the Type Code at the Name plate

\*\* DCS500/DCS600 Thyr. Modules SKKT 106 / 16E are not identical to Thyr. Modules SKKT 106 B/16E used for DCS400 Converter Modules

Module contains:		2Q	4Q		
<b>13.00 270 A (600V) CONVERTER</b>					
DESCRIPTION	2 Q	4 Q	CODE	TYPE/DATA	NOTES
Thyristor modules	3	6	DCA0011957P1	SKKT132/20E	
Power interface board	1	1	3ADT312500R2	<b>SDCS-PIN 206B</b>	Repl. SDCS PIN-23 and PIN206
Fuse F101- F103 on PIN206B	3	3	3BSC770010R0101	KTK-R6A/660V	
Semiconductor fuses	3	3	DCA0003547P1	170M3819	
Cooling fan	1	1	DCA0012171P1	W2E200-HH38-06	

Module contains:		2Q	4Q		
<b>14.00 350 A (400V-500V) CONVERTER</b>					
DESCRIPTION	2 Q	4 Q	CODE	TYPE/DATA	NOTES
Thyristor modules	3	6	DCA0011965P1	SKKT 162 / 16E	alt.TT162N16KOF - GHSN610178P2
Power interface board	1	1	3ADT312500R1	<b>SDCS-PIN 205B</b>	Repl. SDCS PIN-21 and PIN205
Fuse F101- F103 on PIN205B	3	3	3BSC770010R0101	KTK-R6A/660V	
Semiconductor fuses	3	3	DCA0012708P1	170M5810	
Cooling fan	1	1	DCA0012171P1	W2E200-HH38-06	

Module contains:		2Q	4Q		
<b>15.00 450 A (400V-500V) CONVERTER</b>					
DESCRIPTION	2 Q	4 Q	CODE	TYPE/DATA	NOTES
Thyristor modules	3	6	DCA0011973P1	SKKT250/16E	alt.TT250N16KOF-GHSN610089P2
Power interface board	1	1	3ADT312500R1	<b>SDCS-PIN 205B</b>	Repl. SDCS PIN-21 and PIN205
Fuse F101- F103 on PIN205B	3	3	3BSC770010R0101	KTK-R6A/660V	
Semiconductor fuses	3	3	DCA0012716P1	170M6811	
Cooling fan	1	1	DCA0012171P1	W2E200-HH38-06	

Module contains:		2Q	4Q		
<b>16.00 450 A (600V) CONVERTER</b>					
DESCRIPTION	2 Q	4 Q	CODE	TYPE/DATA	NOTES
Thyristor modules	3	6	DCA0011981P1	SKKT210/20E	alt.TT250N18KOF
Power interface board	1	1	3ADT312500R2	<b>SDCS-PIN 206B</b>	Repl. SDCS PIN-23 and PIN206
Fuse F101- F103 on PIN206B	3	3	3BSC770010R0101	KTK-R6A/660V	
Semiconductor fuses	3	3	DCA0012716P1	170M6811	
Cooling fan	1	1	DCA0012171P1	W2E200-HH38-06	

Module contains:		2Q	4Q		
<b>17.00 520 A (400V-500V) CONVERTER</b>					
DESCRIPTION	2 Q	4 Q	CODE	TYPE/DATA	NOTES
Thyristor modules	3	6	DCA0011973P1	SKKT250/16E	alt.TT250N16KOF-GHSN610089P2
Power interface board	1	1	3ADT312500R1	<b>SDCS-PIN 205B</b>	Repl. SDCS PIN-21 and PIN205
Fuse F101- F103 on PIN205B	3	3	3BSC770010R0101	KTK-R6A/660V	
Semiconductor fuses	3	3	DCA0012716P1	170M6811	
Cooling fan	1	1	DCA0012171P1	W2E200-HH38-06	

## Appendix A- Spare Parts List

### Item 18.10 till 18.30 ; New C2b Modules with 680A, 820A and 1000A

Module contains:		2Q	4Q			
18.10	680 A (400V-500V) CONVERTER			CODE	TYPE/DATA	NOTES
DESCRIPTION		2 Q	4 Q	CODE	TYPE/DATA	NOTES
Thyristor modules		3	6	3ADC340032P1	TT 425 N16KOF	
Power interface board		1	1	3ADT312500R1	<b>SDCS-PIN 205B</b>	Repl. SDCS PIN-21 and PIN205
Fuse F101- F103 on PIN205B		3	3	3BSC770010R0101	KTK-R6A/660V	
Semiconductor fuses:Knife Type		3	3	DCA001272P1	170M6813	used till 02/2005; Knife Type
Semiconductor fuses:Blade Type		3	3	3ADC770010P6	170M6163	used from 03/2005; Screw Type
Cooling fan		1	1	DCA0012171P1	W2E200-HH38-06	

Module contains:		2Q	4Q			
18.20	820 A (400V-500V) CONVERTER			CODE	TYPE/DATA	NOTES
DESCRIPTION		2 Q	4 Q	CODE	TYPE/DATA	NOTES
Thyristor modules		3	6	3ADC340066P1	TT 570 N16KOF	
Power interface board		1	1	3ADT312500R1	<b>SDCS-PIN 205B</b>	Repl. SDCS PIN-21 and PIN205
Fuse F101- F103 on PIN205B		3	3	3BSC770010R0101	KTK-R6A/660V	
Semiconductor fuses:Knife Type		3	3	DCA001272P1	170M6813	used till 02/2005; Knife Type
Semiconductor fuses:Blade Type		3	3	3ADC770010P6	170M6163	used from 03/2005; Screw Type
Cooling fan		1	1	DCA0012171P1	W2E200-HH38-06	

Module contains:		2Q	4Q			
18.30	1000 A (400V-500V) CONVERTER			CODE	TYPE/DATA	NOTES
DESCRIPTION		2 Q	4 Q	CODE	TYPE/DATA	NOTES
Thyristor modules		3	6	3ADC340066P1	TT 570 N16KOF	
Power interface board		1	1	3ADT312500R1	<b>SDCS-PIN 205B</b>	Repl. SDCS PIN-21 and PIN205
Fuse F101- F103 on PIN205B		3	3	3BSC770010R0101	KTK-R6A/660V	
Semiconductor fuses/Module *		3	3	3ADC770010P9	170M6166	
Cooling fan		1	1	3ADT754017P1	W2E250-HL06-10	( ident. with W2E....06-08 )



## Item 19.00 to 24.00 New A5 Module DCS500B/ DCS600 Size A5 900A----2000A

19.01 Common Parts for A5 Modules from 900A ---2000A (Item 19.00 - 24.00)					
DESCRIPTION	2 Q	4 Q	CODE	TYPE/DATA	NOTES
Temperatur Sensor (R57)	1	1	3ADT710003P1	KTY 2K-M4-800	A5 Modules; item 19.00 - 24.00

Module contains: 2Q 4Q

19.00 DCSxxx-903-61/71; 900 A (600V-690V) CONVERTER					
DESCRIPTION	2 Q	4 Q	CODE	TYPE/DATA	NOTES
Thyristor	6	12	DCA0012007P1	T459N24TOF	
Puls transformer board	1	2	3BSE004939R2	SDCS-PIN-48	former type SDCS-PIN-41 A
Power interface board	1	1	3BSE004940R1	SDCS-PIN-51	
Semiconductor fuses	6	6	3ADC770009P7	170M6144	
Cooling fan	1	1	3ADT754018P1	D2E 160-AH02-15	

Module contains: 2Q 4Q

20.00 DCSxxx-1203-41/51...; 1200 A (400V-500V) CONV. (not used for "1200T" Cab.)					
DESCRIPTION	2 Q	4 Q	CODE	TYPE/DATA	NOTES
Thyristor	6	12	DCA0012015P1	T589N18TOF	
Puls transformer board	1	2	3BSE004939R2	SDCS-PIN-48	former type SDCS-PIN-41 A
Power interface board	1	1	3BSE004940R1	SDCS-PIN-51	
Semiconductor fuses	6	6	3ADC770010P5	170M6162	
Cooling fan	1	1	3ADT754018P1	D2E 160-AH02-15	

Module contains: 2Q 4Q

21.00 DCSxxx-1503-41/51...; 1500 A (400V-500V) CONV. (used for "1200T" Cab.)					
DESCRIPTION	2 Q	4 Q	CODE	TYPE/DATA	NOTES
Thyristor	6	12	3ADC340077P1	T 918-1770-18	former Type 5STP18F1800
Puls transformer board	1	2	3BSE004939R2	SDCS-PIN-48	former type SDCS-PIN-41 A
Power interface board	1	1	3BSE004940R1	SDCS-PIN-51	
Semiconductor fuses	6	6	3ADC770010P9	170M6166	
Cooling fan	1	1	3ADT754018P1	D2E 160-AH02-15	

Module contains: 2Q 4Q

22.00 DCSxxx-1503-61/71...; 1500 A (600V-690V) CONVERTER					
DESCRIPTION	2 Q	4 Q	CODE	TYPE/DATA	NOTES
Thyristor	6	12	3ADC340085P1	TV 918-1500-28	former Type 5STP16F2400/2800
Puls transformer board	1	2	3BSE004939R2	SDCS-PIN-48	former type SDCS-PIN-41 A
Power interface board	1	1	3BSE004940R1	SDCS-PIN-51	
Semiconductor fuses	6	6	3ADC770009P12	170M6149	
Cooling fan	1	1	3ADT754018P1	D2E 160-AH02-15	

Module contains: 2Q 4Q

23.00 DCSxxx-2003-41/51...; 2000 A (400V-500V) CONVERTER					
DESCRIPTION	2 Q	4 Q	CODE	TYPE/DATA	NOTES
Thyristor	6	12	3ADC340078P1	T 918-2000-18	former Type 5STP1818F0003
Puls transformer board	1	2	3BSE004939R2	SDCS-PIN-48	former type SDCS-PIN-41 A
Power interface board	1	1	3BSE004940R1	SDCS-PIN-51	
Semiconductor fuses	6	6	3ADC770010P12	170M6169	
Cooling fan	1	1	3ADT754018P1	D2E 160-AH02-15	

Module contains: 2Q \* as 4 Quadrant Module with 600/690V not available

24.00 DCSxx1-2003-61/71...; 2000 A (600V-690V) CONVERTER					
DESCRIPTION	2 Q	4 Q	CODE	TYPE/DATA	NOTES
Thyristor	6	---	3ADC340090P1	TV 989-2700-28	former Type 5STP24H2800
Puls transformer board	1	---	3BSE004939R2	SDCS-PIN-48	former type SDCS-PIN-41 A
Power interface board	1	---	3BSE004940R1	SDCS-PIN-51	
Semiconductor fuses	6	---	3ADC770009P13	170M6151	
Cooling fan	1	---	3ADT754018P1	D2E 160-AH02-15	

## Appendix A - Spare Parts List

### Item 40.00 to 49.00 Module DCS500B / DCS600 Size A6 1900A----3000A ; 400V - 790V-AC

40.00 Common Parts for all A6 Mod. from 1900A ----3000A (Item 40.00 - 56.00)					
DESCRIPTION	2 Q	4 Q	CODE	TYPE/DATA	NOTES
Air Flow detector ( P1)	1	1	DCF1066659P1	P 233A-4-AHC	( replac. former P 33 AB )
Temperatur Sensor ( R57)	1	1	DCA0012139P4	KTY 10-6 M4	( A6/1200mm cable)
Current Transformer 2500/1A	2	2	3ADT751010P1	LT2032 2500/1A	T51/T52 for A5 and A6 Range

Module contains: 2Q 4Q

41.00 DCSxxx-1903-81-.. (790V) ( AC-DC Connect. only on Left side )					
DESCRIPTION	2 Q	4 Q	CODE	TYPE/DATA	NOTES
Thyristor	6	12	3ADC340081P1	T 1329N22TOF	
Puls transformer board	1	2	3BSE004939R2	SDCS-PIN-48	former type SDCS-PIN-41 A
Power interface board	1	1	3BSE004940R1	SDCS-PIN-51	
Semiconductor fuses	12	12	3ADC770009P7	170M6144	F11 - F16/double fuses
Cooling fan	1	1	3ADT754008P1	GR31M-...(500V)	380V - 500V/ 50/60Hz

Module contains: 2Q 4Q

42.00 DCSxxx-2053-51-.. (500V) ( AC-DC Connect. only on Left side )					
DESCRIPTION	2 Q	4 Q	CODE	TYPE/DATA	NOTES
Thyristor	6	12	3ADC340081P1	T 1329N22TOF	
Puls transformer board	1	2	3BSE004939R2	SDCS-PIN-48	former type SDCS-PIN-41 A
Power interface board	1	1	3BSE004940R1	SDCS-PIN-51	
Semiconductor fuses	6	6	3ADC770010P11	170M6168	F11 - F 16/single Fuses
Cooling fan	1	1	3ADT754008P1	GR31M-...(500V)	380V - 500V/ 50/60Hz

Module contains: 2Q 4Q

43.00 DCSxxx-2053-61/71-.. (600V - 690V) ( AC-DC Connect. only on Left side )					
DESCRIPTION	2 Q	4 Q	CODE	TYPE/DATA	NOTES
Thyristor	6	12	3ADC340081P1	T 1329N22TOF	
Puls transformer board	1	2	3BSE004939R2	SDCS-PIN-48	former type SDCS-PIN-41 A
Power interface board	1	1	3BSE004940R1	SDCS-PIN-51	
Semiconductor fuses	12	12	3ADC770009P8	170M6145	F11 - F16/double fuses
Cooling fan	1	1	3ADT754008P2	GR31M-...(690V)	525V - 690V/ 50/60Hz

Next bigger A6 Modules with AC-Supply 3 x 790V => DCSxxx-1903-xx-81 see item 41.00

Module contains: 2Q 4Q

44.00 DCSxxx-2503-41/51-.. (400V - 500V) ( AC-DC Connect. only on Left side )					
DESCRIPTION	2 Q	4 Q	CODE	TYPE/DATA	NOTES
Thyristor for DCSxx1-; 2Q	6	-	3ADC340089P1	T 989-3030-18	
Thyristor for DCSxx2-; 4Q	-	6	3ADC340079P1	5 STB 24 Q2800	Bidirectional Contr. Thyristor
Puls transformer board f. 2Q module	1	-	3BSE004939R2	SDCS-PIN-48	former type SDCS-PIN-41 A
Puls transformer board f. 4Q module	-	2	3BSE004939R1003	SDCS-PIN-46-coat	
Power interface board	1	1	3BSE004940R1	SDCS-PIN-51	
Semiconductor fuses	12	12	3ADC770010P6	170M6163	F11 - F16/double fuses
Cooling fan	1	1	3ADT754008P1	GR31M-...(500V)	380V - 500V/ 50/60Hz

Module contains:		2Q	4Q			
<b>45.00</b>	<b>DCSxxx-2503-61/71-.. (600V - 690V) ( AC-DC Connect. only on Left side )</b>					
DESCRIPTION	2 Q	4 Q	CODE	TYPE/DATA	NOTES	
Thyristor for DCSxx1-; 2Q	6	-	3ADC340090P1	TV 989-2700-28		
Thyristor for DCSxx2-; 4Q	-	6	3ADC340079P1	5 STB 24 Q2800	Bidirectional Contr. Thyristor	
Puls transformer board f. 2Q module	1	-	3BSE004939R2	SDCS-PIN-48	former type SDCS-PIN-41 A	
Puls transformer board f. 4Q module	-	2	3BSE004939R1003	SDCS-PIN-46-coat		
Power interface board	1	1	3BSE004940R1	SDCS-PIN-51		
Semiconductor fuses	12	12	3ADC770009P11	170M6148	F11 - F16/double fuses	
Cooling fan	1	1	3ADT754008P2	GR31M-..(690V)	525V - 690V/ 50/60Hz	

Module contains:		2Q	4Q			
<b>46.00</b>	<b>DCSxxx-2503-81-.. (790V) ( AC-DC Connect. only on Left side )</b>					
DESCRIPTION	2 Q	4 Q	CODE	TYPE/DATA	NOTES	
Thyristor for DCSxx1-; 2Q	6	-	3ADC340087P1	TV 989-2770-28		
Thyristor for DCSxx2-; 4Q	-	6	3ADC340079P1	5 STB 24 Q2800	Bidirectional Contr. Thyristor	
Puls transformer board f. 2Q module	1	-	3BSE004939R2	SDCS-PIN-48	former type SDCS-PIN-41 A	
Puls transformer board f. 4Q module	-	2	3BSE004939R1003	SDCS-PIN-46-coat		
Power interface board	1	1	3BSE004940R1	SDCS-PIN-51		
Semiconductor fuses	12	12	3ADC770009P11	170M6148	F11 - F16/double fuses	
Cooling fan	1	1	3ADT754008P1	GR31M-..(500V)	380V - 500V/ 50/60Hz	

Module contains:		2Q	4Q			
<b>47.00</b>	<b>DCSxxx-3003-41/51-.. (400V - 500V) ( AC-DC Connect. only on Left side )</b>					
DESCRIPTION	2 Q	4 Q	CODE	TYPE/DATA	NOTES	
Thyristor for DCSxx1-; 2Q	6	-	3ADC340088P1	T 989-3300-18		
Thyristor for DCSxx2-; 4Q	-	6	3ADC340079P1	5 STB 24 Q2800	Bidirectional Contr. Thyristor	
Puls transformer board f. 2Q module	1	-	3BSE004939R2	SDCS-PIN-48	former type SDCS-PIN-41 A	
Puls transformer board f. 4Q module	-	2	3BSE004939R1003	SDCS-PIN-46-coat		
Power interface board	1	1	3BSE004940R1	SDCS-PIN-51		
Semiconductor fuses 2Q M.	12	-	3ADC770010P11	170M6168	F11 - F 16/double Fuses	
Semiconductor fuses 4Q M.	-	12	3ADC770010P9	170M6166	F11 - F 16/double Fuses	
Cooling fan	1	1	3ADT754008P1	GR31M-..(500V)	380V - 500V/ 50/60Hz	

Module contains:		2Q	4Q			
<b>48.00</b>	<b>DCSxxx-3003-61/71-.. (600V - 690V) ( AC-DC Connect. only on Left side )</b>					
DESCRIPTION	2 Q	4 Q	CODE	TYPE/DATA	NOTES	
Thyristor for DCSxx1-; 2Q	6	-	3ADC340046P2	5STP 3328L0003		
Thyristor for DCSxx2-; 4Q	-	6	3ADC340079P1	5 STB 24 Q2800	Bidirectional Contr. Thyristor	
Puls transformer board f. 2Q module	1	-	3BSE004939R2	SDCS-PIN-48	former type SDCS-PIN-41 A	
Puls transformer board f. 4Q module	-	2	3BSE004939R1003	SDCS-PIN-46-coat		
Power interface board	1	1	3BSE004940R1	SDCS-PIN-51		
Semiconductor fuses 2Q M.	12	-	3ADC770009P12	170M6149	F11 - F 16/double Fuses	
Semiconductor fuses 4Q M.	-	12	3ADC770009P11	170M6148	F11 - F16/double fuses	
Cooling fan	1	1	3ADT754008P2	GR31M-..(690V)	525V - 690V/ 50/60Hz	

Module contains:		2Q	4Q			
<b>49.00</b>	<b>DCSxxx-3003-81-.. (790V) ( AC-DC Connect. only on Left side )</b>					
DESCRIPTION	2 Q	4 Q	CODE	TYPE/DATA	NOTES	
Thyristor for DCSxx1-; 2Q	6	-	3ADC340046P2	5STP 3328L0003		
Thyristor for DCSxx2-; 4Q	-	6	3ADC340079P1	5 STB 24 Q2800	Bidirectional Contr. Thyristor	
Puls transformer board f. 2Q module	1	-	3BSE004939R2	SDCS-PIN-48	former type SDCS-PIN-41 A	
Puls transformer board f. 4Q module	-	2	3BSE004939R1003	SDCS-PIN-46-coat		
Power interface board	1	1	3BSE004940R1	SDCS-PIN-51		
Semiconductor fuses 2Q M.	12	-	3ADC770009P12	170M6149	F11 - F 16/double Fuses	
Semiconductor fuses 4Q M.	-	12	3ADC770009P11	170M6148	F11 - F16/double fuses	
Cooling fan	1	1	3ADT754008P1	GR31M-..(500V)	380V - 500V/ 50/60Hz	

## Appendix A- Spare Parts List

Item 50.00 to 65.00 Module DCS500B / DCS600 Size A7 2053A----5203A ; 400V - 1190V-AC

50.00 Common Parts for all A7 Mod. from 2053A ----5203A (Item 50.00 - 65.00)					
DESCRIPTION	2 Q	4 Q	CODE	TYPE/DATA	NOTES
Air Flow detector ( P1)	1	1	DCF1066659P1	P233 A-4 AHC	
Temperatur Sensor (R57)	1	1	DCA0012139P5	KTY 10-6 -M4	(A7: 1750mm cable )
Current Transformer 4000/1A	2	2	3ADT751007P1	4000/1A	T51/T52 for C4/A7 Range /1200V

Module contains: 2Q 4Q

51.00 DCSxxx-2053-91-.. (1000V) ( AC-DC Conn.on Left side L ; or Right side R )					
DESCRIPTION	2 Q	4 Q	CODE	TYPE/DATA	NOTES
Thyristor	6	12	3ADC340086P1	TV 989-2700-30	
Puls transformer board	1	2	3BSE004939R2	SDCS-PIN-48	former type SDCS-PIN-41 A
Power interface board	1	1	3BSE004940R1	SDCS-PIN-51	
Semiconductor fuses	6	6	3ADC770030P3	170M 7976	
Cooling fan	1	1	3ADT754020P1	GR 35C	400V - 690V/50/60Hz

For A7 Modules Ventilator is the same for left-side or right-side Busbar Connection

Module contains: 2Q 4Q

52.00 DCSxxx-2603-91-.. (1000V) ( AC-DC Conn.on Left side L ; or Right side R )					
DESCRIPTION	2 Q	4 Q	CODE	TYPE/DATA	NOTES
Thyristor	6	12	3ADC340086P1	TV 989-2700-30	
Puls transformer board	1	2	3BSE004939R2	SDCS-PIN-48	former type SDCS-PIN-41 A
Power interface board	1	1	3BSE004940R1	SDCS-PIN-51	
Semiconductor fuses	6	6	3ADC770030P3	170M 7976	
Cooling fan	1	1	3ADT754020P1	GR 35C	400V - 690V/50/60Hz

For A7 Modules Ventilator is the same for left-side or right-side Busbar Connection

Module contains: 2Q 4Q

53.00 DCSxxx-2603-11-.. (1190V) ( AC-DC Conn.on Left side L ; or Right side R )					
DESCRIPTION	2 Q	4 Q	CODE	TYPE/DATA	NOTES
Thyristor	6	12	DCA0012066P1	5 STP 28L 3600	
Puls transformer board	1	2	3BSE004939R2	SDCS-PIN-48	former type SDCS-PIN-41 A
Power interface board	1	1	3ADT780007R1	SDCS-PIN-51-1190	
Semiconductor fuses	6	6	3ADC770025P1	170M 7518	
Cooling fan	1	1	3ADT754020P1	GR 35C	400V - 690V/50/60Hz

For A7 Modules Ventilator is the same for left-side or right-side Busbar Connection

Module contains:		2Q	4Q			
<b>54.00</b>	<b>DCSxxx-3303-41/51-.. (400-500V) ( AC-DC Conn.on Left side L ; or Right side R )</b>					
DESCRIPTION	2 Q	4 Q	CODE	TYPE/DATA	NOTES	
Thyristor	6	12	3ADC340089P1	T 989-3030-18		
Puls transformer board	1	2	3BSE004939R2	SDCS-PIN-48	former type SDCS-PIN-41 A	
Power interface board	1	1	3BSE004940R1	SDCS-PIN-51		
Semiconductor fuses	6	6	DCA0012821P1	170M 7026		
Cooling fan	1	1	3ADT754020P1	GR 35C	400V - 690V/50/60Hz	

For A7 Modules Ventilator is the same for left-side or right-side Busbar Connection

Module contains:		2Q	4Q			
<b>55.00</b>	<b>DCSxxx-3303-61/71-.. (600-690V) ( AC-DC Conn.on Left side L ; or Right side R )</b>					
DESCRIPTION	2 Q	4 Q	CODE	TYPE/DATA	NOTES	
Thyristor	6	12	3ADC340087P1	TV 989-2770-28		
Puls transformer board	1	2	3BSE004939R2	SDCS-PIN-48	former type SDCS-PIN-41 A	
Power interface board	1	1	3BSE004940R1	SDCS-PIN-51		
Semiconductor fuses	6	6	DCA0012856P1	170M 7036		
Cooling fan	1	1	3ADT754020P1	GR 35C	400V - 690V/50/60Hz	

For A7 Modules Ventilator is the same for left-side or right-side Busbar Connection

Module contains:		2Q	4Q			
<b>56.00</b>	<b>DCSxxx-3303-81-.. (790V) ( AC-DC Conn.on Left side L ; or Right side R )</b>					
DESCRIPTION	2 Q	4 Q	CODE	TYPE/DATA	NOTES	
Thyristor	6	12	3ADC340087P1	TV 989-2770-28		
Puls transformer board	1	2	3BSE004939R2	SDCS-PIN-48	former type SDCS-PIN-41 A	
Power interface board	1	1	3BSE004940R1	SDCS-PIN-51		
Semiconductor fuses	6	6	DCA0012856P1	170M 7036		
Cooling fan	1	1	3ADT754020P1	GR 35C	400V - 690V/50/60Hz	

For A7 Modules Ventilator is the same for left-side or right-side Busbar Connection

Module contains:		2Q	4Q			
<b>57.00</b>	<b>DCSxxx-3303-91-.. (1000V) ( AC-DC Conn.on Left side L ; or Right side R )</b>					
DESCRIPTION	2 Q	4 Q	CODE	TYPE/DATA	NOTES	
Thyristor	6	12	3ADC340084P1	5 STP 38 Q3600		
Puls transformer board	1	2	3BSE004939R2	SDCS-PIN-48	former type SDCS-PIN-41 A	
Power interface board	1	1	3BSE004940R1	SDCS-PIN-51		
Semiconductor fuses	6	6	3ADC770030P5	170M 7978		
Cooling fan	1	1	3ADT754020P1	GR 35C	400V - 690V/50/60Hz	

For A7 Modules Ventilator is the same for left-side or right-side Busbar Connection

Module contains:		2Q	4Q			
<b>58.00</b>	<b>DCSxxx-3303-11-.. (1190V) ( AC-DC Conn.on Left side L ; or Right side R )</b>					
DESCRIPTION	2 Q	4 Q	CODE	TYPE/DATA	NOTES	
Thyristor	6	12	3ADC340084P1	5 STP 38 Q3600		
Puls transformer board	1	2	3BSE004939R2	SDCS-PIN-48	former type SDCS-PIN-41 A	
Power interface board	1	1	3ADT780007R1	SDCS-PIN-51-1190		
Semiconductor fuses	6	6	3ADC770030P6	170M 7589		
Cooling fan	1	1	3ADT754020P1	GR 35C	400V - 690V/50/60Hz	

For A7 Modules Ventilator is the same for left-side or right-side Busbar Connection

## Appendix A- Spare Parts List

Module contains:		2Q	4Q		
<b>59.00</b>	<b>DCSxxx-4003-41/51-... (400-500V) ( AC-DC Conn.on Left side L ; or Right side R )</b>				
DESCRIPTION	2 Q	4 Q	CODE	TYPE/DATA	NOTES
Thyristor	6	12	3ADC340088P1	T 989-3300-18	
Puls transformer board	1	2	3BSE004939R2	SDCS-PIN-48	former type SDCS-PIN-41 A
Power interface board	1	1	3BSE004940R1	SDCS-PIN-51	
Semiconductor fuses	6	6	DCA0012830P1	170M 7028	
Cooling fan	1	1	3ADT754020P1	GR 35C	400V - 690V/50/60Hz

For A7 Modules Ventilator is the same for left-side or right-side Busbar Connection

Module contains:		2Q	4Q		
<b>60.00</b>	<b>DCSxxx-4003-61/71-... (600-690V) ( AC-DC Conn.on Left side L ; or Right side R )</b>				
DESCRIPTION	2 Q	4 Q	CODE	TYPE/DATA	NOTES
Thyristor	6	12	3ADC340046P2	5 STP 3328 L0003	
Puls transformer board	1	2	3BSE004939R2	SDCS-PIN-48	former type SDCS-PIN-41 A
Power interface board	1	1	3BSE004940R1	SDCS-PIN-51	
Semiconductor fuses	6	6	3ADC770030P2	170M 7156	
Cooling fan	1	1	3ADT754020P1	GR 35C	400V - 690V/50/60Hz

For A7 Modules Ventilator is the same for left-side or right-side Busbar Connection

Module contains:		2Q	4Q		
<b>61.00</b>	<b>DCSxxx-4003-81-... (790V) ( AC-DC Conn.on Left side L ; or Right side R )</b>				
DESCRIPTION	2 Q	4 Q	CODE	TYPE/DATA	NOTES
Thyristor	6	12	3ADC340046P2	5 STP 3328 L0003	
Puls transformer board	1	2	3BSE004939R2	SDCS-PIN-48	former type SDCS-PIN-41 A
Power interface board	1	1	3BSE004940R1	SDCS-PIN-51	
Semiconductor fuses	6	6	3ADC770030P2	170M 7156	
Cooling fan	1	1	3ADT754020P1	GR 35C	400V - 690V/50/60Hz

For A7 Modules Ventilator is the same for left-side or right-side Busbar Connection

Module contains:		2Q	4Q		
<b>62.00</b>	<b>DCSxxx-4003-91-... (1000V) ( AC-DC Conn.on Left side L ; or Right side R )</b>				
DESCRIPTION	2 Q	4 Q	CODE	TYPE/DATA	NOTES
Thyristor	6	12	3ADC340084P1	5 STP 38 Q3600	
Puls transformer board	1	2	3BSE004939R2	SDCS-PIN-48	former type SDCS-PIN-41 A
Power interface board	1	1	3BSE004940R1	SDCS-PIN-51	
Semiconductor fuses	6	6	3ADC770030P5	170M 7978	
Cooling fan	1	1	3ADT754020P1	GR 35C	400V - 690V/50/60Hz

For A7 Modules Ventilator is the same for left-side or right-side Busbar Connection

Module contains:		2Q	4Q		
<b>63.00</b>	<b>DCSxxx-4803-61/71-... (600-690V) ( AC-DC Conn.on Left side L ; or Right side R )</b>				
DESCRIPTION	2 Q	4 Q	CODE	TYPE/DATA	NOTES
Thyristor	6	12	3ADC340083P1	5 STP 45 Q2800	
Puls transformer board	1	2	3BSE004939R2	SDCS-PIN-48	former type SDCS-PIN-41 A
Power interface board	1	1	3BSE004940R1	SDCS-PIN-51	
Semiconductor fuses	6	6	3ADC770030P2	170M 7156	
Cooling fan	1	1	3ADT754020P1	GR 35C	400V - 690V/50/60Hz

For A7 Modules Ventilator is the same for left-side or right-side Busbar Connection

Module contains:		2Q	4Q		
<b>64.00</b>	<b>DCSxxx-4803-81-... (790V) ( AC-DC Conn.on Left side L ; or Right side R )</b>				
DESCRIPTION	2 Q	4 Q	CODE	TYPE/DATA	NOTES
Thyristor	6	12	3ADC340083P1	5 STP 45 Q2800	
Puls transformer board	1	2	3BSE004939R2	SDCS-PIN-48	former type SDCS-PIN-41 A
Power interface board	1	1	3BSE004940R1	SDCS-PIN-51	
Semiconductor fuses	6	6	3ADC770030P2	170M 7156	
Cooling fan	1	1	3ADT754020P1	GR 35C	400V - 690V/50/60Hz

For A7 Modules Ventilator is the same for left-side or right-side Busbar Connection

Module contains:		2Q	4Q		
<b>65.00</b>	<b>DCSxxx-5203-41/51-... (400-500V) ( AC-DC Conn.on Left side L ; or Right side R )</b>				
DESCRIPTION	2 Q	4 Q	CODE	TYPE/DATA	NOTES
Thyristor	6	12	3ADC340083P1	5 STP 45 Q2800	
Puls transformer board	1	2	3BSE004939R2	SDCS-PIN-48	former type SDCS-PIN-41 A
Power interface board	1	1	3BSE004940R1	SDCS-PIN-51	
Semiconductor fuses	6	6	3ADC770030P1	170M 7057	
Cooling fan	1	1	3ADT754020P1	GR 35C	400V - 690V/50/60Hz

## Item 25.00 to 38.00 Module DCS500B / DCS600 Size C4 2050A----5150A ; 400V - 1190V-AC

25.00 Common Parts for all C4 Mod. from 2050 ----5150 (Item 25.10 - 38.00)					
DESCRIPTION	2 Q	4 Q	CODE	TYPE/DATA	NOTES
Air Flow detector ( P1)	1	1	DCF1066659P1	P233 A-4 AHC	
Temperatur Sensor (R57)	1	1	DCA0012139P3	KTY 10-6 M4	(C4 / 950mm cable )

Module contains:	2Q	4Q
------------------	----	----

25.10 DCSxxx-2050 (600V-690V-790V) CONVERTER Left & Right					
DESCRIPTION	2 Q	4 Q	CODE	TYPE/DATA	NOTES
Thyristor	6	12	DCA0016142P1	5STP16F2800	
Puls transformer board	1	2	3BSE004939R2	SDCS-PIN-48	former type SDCS-PIN-41 A
Power interface board	1	1	3BSE004940R1	SDCS-PIN-51	
Semiconductor fuses	6	6	DCA0017149P1	170M7031	
*)Cooling fan (Bus Bars"Left side")	1	1	DCA0018692P1	RG35P-4DK.7M.1R	e.g. DCSxxx-2050-61L21P..
*)Cooling fan (Bus Bars"Right side")	1	1	DCA0012660P1	RG35P-4DK.7M.1L	e.g. DCSxxx-2050-61R21P..

\*) Select only one Cooling Fan for this C4 Modules; Please check Type designation or delivered Design about Busbar arrangement

Module contains:	2Q	4Q
------------------	----	----

26.00 DCSxxx-2050 (1000V) CONVERTER					
DESCRIPTION	2 Q	4 Q	CODE	TYPE/DATA	NOTES
Thyristor	6	12	DCA0012058P1	5STP18L3600	
Puls transformer board	1	2	3BSE004939R2	SDCS-PIN-48	former type SDCS-PIN-41 A
Power interface board	1	1	3BSE004940R1	SDCS-PIN-51	
Semiconductor fuses	6	6	DCA0012864P1	170M7510	
*)Cooling fan (Bus Bars"Left side")	1	1	DCA0018692P1	RG35P-4DK.7M.1R	e.g. DCSxxx-2050-91L21P..
*)Cooling fan (Bus Bars"Right side")	1	1	DCA0012660P1	RG35P-4DK.7M.1L	e.g. DCSxxx-2050-91R21P..

\*) Select only one Cooling Fan for this C4 Modules; Please check Type designation or delivered Design about Busbar arrangement

Module contains:	2Q	4Q
------------------	----	----

27.00 DCSxxx-2500 (400V-500V) CONVERTER					
DESCRIPTION	2 Q	4 Q	CODE	TYPE/DATA	NOTES
Thyristor	6	12	DCA0016169P1	5STP24L2800	
Puls transformer board	1	2	3BSE004939R2	SDCS-PIN-48	former type SDCS-PIN-41 A
Power interface board	1	1	3BSE004940R1	SDCS-PIN-51	
Semiconductor fuses	6	6	DCA0012848P1	170M7034	
*)Cooling fan (Bus Bars"Left side")	1	1	DCA0018692P1	RG35P-4DK.7M.1R	e.g. DCSxxx-2500-41L21P..
*)Cooling fan (Bus Bars"Right side")	1	1	DCA0012660P1	RG35P-4DK.7M.1L	e.g. DCSxxx-2500-41R21P..

\*) Select only one Cooling Fan for this C4 Modules; Please check Type designation or delivered Design about Busbar arrangement

## Appendix A- Spare Parts List

Module contains:		2Q	4Q			
<b>28.00</b>	<b>DCSxxx-2500 (600V-690V) CONVERTER</b>					
DESCRIPTION	2 Q	4 Q	CODE	TYPE/DATA	NOTES	
Thyristor	6	12	DCA0016169P1	5STP24L2800		
Puls transformer board	1	2	3BSE004939R2	SDCS-PIN-48	former type SDCS-PIN-41 A	
Power interface board	1	1	3BSE004940R1	SDCS-PIN-51		
Semiconductor fuses	6	6	DCA0012848P1	170M7034		
*)Cooling fan (Bus Bars"Left side")	1	1	DCA0018692P1	RG35P-4DK.7M.1R	e.g. DCSxxx-2500-x1L21P..	
*)Cooling fan (Bus Bars"Right side")	1	1	DCA0012660P1	RG35P-4DK.7M.1L	e.g. DCSxxx-2500-x1R21P..	

\*) Select only one Cooling Fan for this C4 Modules; Please check Type designation or delivered Design about Busbar arrangement

Module contains:		2Q	4Q			
<b>29.00</b>	<b>DCSxxx-2650 (1000V) CONVERTER</b>					
DESCRIPTION	2 Q	4 Q	CODE	TYPE/DATA	NOTES	
Thyristor	6	12	DCA0012058P1	5STP18L3600		
Puls transformer board	1	2	3BSE004939R2	SDCS-PIN-48	former type SDCS-PIN-41 A	
Power interface board	1	1	3BSE004940R1	SDCS-PIN-51		
Semiconductor fuses	6	6	DCA0012864P1	170M7510		
*)Cooling fan (Bus Bars"Left side")	1	1	DCA0018692P1	RG35P-4DK.7M.1R	e.g. DCSxxx-2650-x1L21P..	
*)Cooling fan (Bus Bars"Right side")	1	1	DCA0012660P1	RG35P-4DK.7M.1L	e.g. DCSxxx-2650-x1R21P..	

\*) Select only one Cooling Fan for this C4 Modules; Please check Type designation or delivered Design about Busbar arrangement

Module contains:		2Q	4Q			
<b>29.10</b>	<b>DCSxxx-2650 (1190V) CONVERTER</b>					
DESCRIPTION	2 Q	4 Q	CODE	TYPE/DATA	NOTES	
Thyristor	6	12	3ADC340070P1	5STP28L4200		
Puls transformer board	1	2	3BSE004939R2	SDCS-PIN-48	former type SDCS-PIN-41 A	
Power interface board	1	1	3ADT780007R1	SDCS-PIN-51-1190		
Semiconductor fuses	6	6	3ADC770025P1	170M7518		
*)Cooling fan (Bus Bars"Left side")	1	1	DCA0018692P1	RG35P-4DK.7M.1R	e.g. DCSxxx-3200-x1L21P..	
*)Cooling fan (Bus Bars"Right side")	1	1	DCA0012660P1	RG35P-4DK.7M.1L	e.g. DCSxxx-3200-x1R21P..	

\*) Select only one Cooling Fan for this C4 Modules; Please check Type designation or delivered Design about Busbar arrangement

Module contains:		2Q	4Q			
<b>30.00</b>	<b>DCSxxx-3200 (790V) CONVERTER</b>					
DESCRIPTION	2 Q	4 Q	CODE	TYPE/DATA	NOTES	
Thyristor	6	12	DCA0016169P1	5STP24L2800		
Puls transformer board	1	2	3BSE004939R2	SDCS-PIN-48	former type SDCS-PIN-41 A	
Power interface board	1	1	3BSE004940R1	SDCS-PIN-51		
Semiconductor fuses	6	6	DCA0012848P1	170M7034	changed 09/02 ; bef. 170M7035	
*)Cooling fan (Bus Bars"Left side")	1	1	DCA0018692P1	RG35P-4DK.7M.1R	e.g. DCSxxx-3200-x1L21P..	
*)Cooling fan (Bus Bars"Right side")	1	1	DCA0012660P1	RG35P-4DK.7M.1L	e.g. DCSxxx-3200-x1R21P..	

\*) Select only one Cooling Fan for this C4 Modules; Please check Type designation or delivered Design about Busbar arrangement

Module contains:		2Q	4Q			
<b>31.00</b>	<b>DCSxxx-3200 (1000V) CONVERTER</b>					
DESCRIPTION	2 Q	4 Q	CODE	TYPE/DATA	NOTES	
Thyristor	6	12	DCA0012066P1	5STP28L3600		
Puls transformer board	1	2	3BSE004939R2	SDCS-PIN-48	former type SDCS-PIN-41 A	
Power interface board	1	1	3BSE004940R1	SDCS-PIN-51		
Semiconductor fuses	6	6	DCA0012872P1	170M7513		
*)Cooling fan (Bus Bars"Left side")	1	1	DCA0018692P1	RG35P-4DK.7M.1R	e.g. DCSxxx-3200-x1L21P..	
*)Cooling fan (Bus Bars"Right side")	1	1	DCA0012660P1	RG35P-4DK.7M.1L	e.g. DCSxxx-3200-x1R21P..	

\*) Select only one Cooling Fan for this C4 Modules; Please check Type designation or delivered Design about Busbar arrangement



Module contains:		2Q	4Q		
<b>31.10</b>	<b>DCSxxx-3200 (1190V) CONVERTER</b>				
DESCRIPTION	2 Q	4 Q	CODE	TYPE/DATA	NOTES
Thyristor	6	12	3ADC340062P3	5STP38N4200	
Puls transformer board	1	2	3BSE004939R2	SDCS-PIN-48	former type SDCS-PIN-41 A
Power interface board	1	1	3ADT780007R1	SDCS-PIN-51-1190	
Semiconductor fuses	6	6	DCA0012881P1	170M7520	
*)Cooling fan (Bus Bars"Left side")	1	1	DCA0018692P1	RG35P-4DK.7M.1R	e.g. DCSxxx-3200-x1L21P..
*)Cooling fan (Bus Bars"Right side")	1	1	DCA0012660P1	RG35P-4DK.7M.1L	e.g. DCSxxx-3200-x1R21P..

\*) Select only one Cooling Fan for this C4 Modules; Please check Type designation or delivered Design about Busbar arrangement

Module contains:		2Q	4Q		
<b>32.00</b>	<b>DCSxxx-3300 (400V-500V) CONVERTER</b>				
DESCRIPTION	2 Q	4 Q	CODE	TYPE/DATA	NOTES
Thyristor	6	12	DCA0016169P1	5STP24L2800	
Puls transformer board	1	2	3BSE004939R2	SDCS-PIN-48	former type SDCS-PIN-41 A
Power interface board	1	1	3BSE004940R1	SDCS-PIN-51	
Semiconductor fuses	6	6	DCA0017271P1	170M7035	
*)Cooling fan (Bus Bars"Left side")	1	1	DCA0018692P1	RG35P-4DK.7M.1R	e.g. DCSxxx-3300-x1L21P..
*)Cooling fan (Bus Bars"Right side")	1	1	DCA0012660P1	RG35P-4DK.7M.1L	e.g. DCSxxx-3300-x1R21P..

\*) Select only one Cooling Fan for this C4 Modules; Please check Type designation or delivered Design about Busbar arrangement

Module contains:		2Q	4Q		
<b>33.00</b>	<b>DCSxxx-3300 (600V-690V) CONVERTER</b>				
DESCRIPTION	2 Q	4 Q	CODE	TYPE/DATA	NOTES
Thyristor	6	12	DCA0016169P1	5STP24L2800	
Puls transformer board	1	2	3BSE004939R2	SDCS-PIN-48	former type SDCS-PIN-41 A
Power interface board	1	1	3BSE004940R1	SDCS-PIN-51	
Semiconductor fuses	6	6	DCA0017271P1	170M7035	
*)Cooling fan (Bus Bars"Left side")	1	1	DCA0018692P1	RG35P-4DK.7M.1R	e.g. DCSxxx-3300-x1L21P..
*)Cooling fan (Bus Bars"Right side")	1	1	DCA0012660P1	RG35P-4DK.7M.1L	e.g. DCSxxx-3300-x1R21P..

\*) Select only one Cooling Fan for this C4 Modules; Please check Type designation or delivered Design about Busbar arrangement

Module contains:		2Q	4Q		
<b>34.00</b>	<b>DCSxxx-4000 (400V-500V) CONVERTER</b>				
DESCRIPTION	2 Q	4 Q	CODE	TYPE/DATA	NOTES
Thyristor	6	12	DCA0016151P1	5STP27L1800	
Puls transformer board	1	2	3BSE004939R2	SDCS-PIN-48	former type SDCS-PIN-41 A
Power interface board	1	1	3BSE004940R1	SDCS-PIN-51	
Semiconductor fuses	6	6	DCA0012821P1	170M7026	
*)Cooling fan (Bus Bars"Left side")	1	1	DCA0018692P1	RG35P-4DK.7M.1R	e.g. DCSxxx-4000-x1L21P..
*)Cooling fan (Bus Bars"Right side")	1	1	DCA0012660P1	RG35P-4DK.7M.1L	e.g. DCSxxx-4000-x1R21P..

\*) Select only one Cooling Fan for this C4 Modules; Please check Type designation or delivered Design about Busbar arrangement

## Appendix A- Spare Parts List

Module contains:		2Q	4Q		
<b>35.00</b>	<b>DCSxxx-4000 (600V-690V) CONVERTER</b>				
DESCRIPTION	2 Q	4 Q	CODE	TYPE/DATA	NOTES
Thyristor	6	12	DCA0016177P1	5STP33L2800	
Puls transformer board	1	2	3BSE004939R2	SDCS-PIN-48	former type SDCS-PIN-41 A
Power interface board	1	1	3BSE004940R1	SDCS-PIN-51	
Semiconductor fuses	6	6	DCA0012856P1	170M7036	
*)Cooling fan (Bus Bars"Left side")	1	1	DCA0018692P1	RG35P-4DK.7M.1R	e.g. DCSxxx-4000-x1L21P..
*)Cooling fan (Bus Bars"Right side")	1	1	DCA0012660P1	RG35P-4DK.7M.1L	e.g. DCSxxx-4000-x1R21P..

\*) Select only one Cooling Fan for this C4 Modules; Please check Type designation or delivered Design about Busbar arrangement

Module contains:		2Q	4Q		
<b>35.10</b>	<b>DCSxxx-4000 (790V) CONVERTER</b>				
DESCRIPTION	2 Q	4 Q	CODE	TYPE/DATA	NOTES
Thyristor	6	12	DCA0016177P1	5STP33L2800	
Puls transformer board	1	2	3BSE004939R2	SDCS-PIN-48	former type SDCS-PIN-41 A
Power interface board	1	1	3BSE004940R1	SDCS-PIN-51	
Semiconductor fuses	6	6	DCA0012856P1	170M7036	
*)Cooling fan (Bus Bars"Left side")	1	1	DCA0018692P1	RG35P-4DK.7M.1R	e.g. DCSxxx-4000-x1L21P..
*)Cooling fan (Bus Bars"Right side")	1	1	DCA0012660P1	RG35P-4DK.7M.1L	e.g. DCSxxx-4000-x1R21P..

\*) Select only one Cooling Fan for this C4 Modules; Please check Type designation or delivered Design about Busbar arrangement

Module contains:		2Q	4Q		
<b>36.00</b>	<b>DCSxxx-4000 (1000V) CONVERTER</b>				
DESCRIPTION	2 Q	4 Q	CODE	TYPE/DATA	NOTES
Thyristor	6	12	DCA0012082P1	5STP38N3600	
Puls transformer board	1	2	3BSE004939R2	SDCS-PIN-48	former type SDCS-PIN-41 A
Power interface board	1	1	3BSE004940R1	SDCS-PIN-51	
Semiconductor fuses	6	6	DCA0012881P1	170M7520	
*)Cooling fan (Bus Bars"Left side")	1	1	DCA0018692P1	RG35P-4DK.7M.1R	e.g. DCSxxx-4000-x1L21P..
*)Cooling fan (Bus Bars"Right side")	1	1	DCA0012660P1	RG35P-4DK.7M.1L	e.g. DCSxxx-4000-x1R21P..

\*) Select only one Cooling Fan for this C4 Modules; Please check Type designation or delivered Design about Busbar arrangement

Module contains:		2Q	4Q		
<b>37.00</b>	<b>DCSxxx-4750 (600V-690V) CONVERTER</b>				
DESCRIPTION	2 Q	4 Q	CODE	TYPE/DATA	NOTES
Thyristor	6	12	DCA0016193P1	5STP45N2800	
Puls transformer board	1	2	3BSE004939R2	SDCS-PIN-48	former type SDCS-PIN-41 A
Power interface board	1	1	3BSE004940R1	SDCS-PIN-51	
Semiconductor fuses	6	6	DCA0012856P1	170M7036	
*)Cooling fan (Bus Bars"Left side")	1	1	DCA0018692P1	RG35P-4DK.7M.1R	e.g. DCSxxx-4750-x1L21P..
*)Cooling fan (Bus Bars"Right side")	1	1	DCA0012660P1	RG35P-4DK.7M.1L	e.g. DCSxxx-4750-x1R21P..

\*) Select only one Cooling Fan for this C4 Modules; Please check Type designation or delivered Design about Busbar arrangement

Module contains:		2Q	4Q		
<b>37.10</b>	<b>DCSxxx-4750 (790V) CONVERTER</b>				
DESCRIPTION	2 Q	4 Q	CODE	TYPE/DATA	NOTES
Thyristor	6	12	DCA0016193P1	5STP45N2800	
Puls transformer board	1	2	3BSE004939R2	SDCS-PIN-48	former type SDCS-PIN-41 A
Power interface board	1	1	3BSE004940R1	SDCS-PIN-51	
Semiconductor fuses	6	6	DCA0012856P1	170M7036	
*)Cooling fan (Bus Bars"Left side")	1	1	DCA0018692P1	RG35P-4DK.7M.1R	e.g. DCSxxx-4750-x1L21P..
*)Cooling fan (Bus Bars"Right side")	1	1	DCA0012660P1	RG35P-4DK.7M.1L	e.g. DCSxxx-4750-x1R21P..

\*) Select only one Cooling Fan for this C4 Modules; Please check Type designation or delivered Design about Busbar arrangement

Module contains:		2Q	4Q		
<b>38.00</b>	<b>DCSxxx-5150 (400 V-500 V) CONVERTER</b>				
DESCRIPTION	2 Q	4 Q	CODE	TYPE/DATA	NOTES
Thyristor	6	12	DCA0016185P1	5STP45N2200	
Puls transformer board	1	2	3BSE004939R2	SDCS-PIN-48	former type SDCS-PIN-41 A
Power interface board	1	1	3BSE004940R1	SDCS-PIN-51	
Semiconductor fuses	6	6	DCA0012830P1	170M7028	
*)Cooling fan (Bus Bars"Left side")	1	1	DCA0018692P1	RG35P-4DK.7M.1R	e.g. DCSxxx-5150-x1L21P..
*)Cooling fan (Bus Bars"Right side")	1	1	DCA0012660P1	RG35P-4DK.7M.1L	e.g. DCSxxx-5150-x1R21P..

\*) Select only one Cooling Fan for this C4 Modules; Please check Type designation or delivered Design about Busbar arrangement

## Appendix A- Spare Parts List

### Item 19.00 to 24.10 Modules DCS500B / DCS600 Size C3 900A----2000A

19.00 Common Parts for all C3 Mod. from 900 ----2000 (Item 19.10 - 24.00)					
DESCRIPTION	2 Q	4 Q	CODE	TYPE/DATA	NOTES
Temperatur Sensor (R57)	1	1	3ADT786209R0001	KTY 10-6 M4	compl. Mount. set C3 (550mm cable)

Module contains: 2Q 4Q

19.10 DCSxxx-900 (400V-500V) CONVERTER					
DESCRIPTION	2 Q	4 Q	CODE	TYPE/DATA	NOTES
Thyristor	6	12	DCA0012015P1	T589N18TOF	
Puls transformer board	1	2	3BSE004939R2	SDCS-PIN-48	former type SDCS-PIN-41 A
Power interface board	1	1	3BSE004940R1	SDCS-PIN-51	
Semiconductor fuses	6	6	DCA0010683P1	170M6035	
Cooling fan	1	1	3ADT754006P1	RD23P-4DW.4I.1R	

Module contains: 2Q 4Q

20.10 DCSxxx-900 (600V-690V) CONVERTER					
DESCRIPTION	2 Q	4 Q	CODE	TYPE/DATA	NOTES
Thyristor	6	12	DCA0012007P1	T459N24TOF	
Puls transformer board	1	2	3BSE004939R2	SDCS-PIN-48	former type SDCS-PIN-41 A
Power interface board	1	1	3BSE004940R1	SDCS-PIN-51	
Semiconductor fuses	6	6	DCA0012791P1	170M6143	
Cooling fan	1	1	3ADT754006P1	RD23P-4DW.4I.1R	

Module contains: 2Q 4Q

21.10 DCSxxx-1200 (400V-500V) CONVERTER					
DESCRIPTION	2 Q	4 Q	CODE	TYPE/DATA	NOTES
Thyristor	6	12	DCA0012015P1	T589N18TOF	
Puls transformer board	1	2	3BSE004939R2	SDCS-PIN-48	former type SDCS-PIN-41 A
Power interface board	1	1	3BSE004940R1	SDCS-PIN-51	
Semiconductor fuses	6	6	DCA0010683P1	170M6035	
Cooling fan	1	1	3ADT754006P1	RD23P-4DW.4I.1R	

Module contains: 2Q 4Q

22.10 DCSxxx-1500 (400V-500V) CONVERTER					
DESCRIPTION	2 Q	4 Q	CODE	TYPE/DATA	NOTES
Thyristor	6	12	DCA0012031P1	5STP18F1800	
Puls transformer board	1	2	3BSE004939R2	SDCS-PIN-48	former type SDCS-PIN-41 A
Power interface board	1	1	3BSE004940R1	SDCS-PIN-51	
Semiconductor fuses	6	6	3ADC770010P9	170M6166	former Id. Nr.DCA0012741P1
Cooling fan	1	1	3ADT754006P1	RD23P-4DW.4I.1R	

Module contains: 2Q 4Q

23.10 DCSxxx-1500 (600V-690V) CONVERTER					
DESCRIPTION	2 Q	4 Q	CODE	TYPE/DATA	NOTES
Thyristor	6	12	DCA0012023P1	5STP16F2400	
Puls transformer board	1	2	3BSE004939R2	SDCS-PIN-48	former type SDCS-PIN-41 A
Power interface board	1	1	3BSE004940R1	SDCS-PIN-51	
Semiconductor fuses	6	6	DCA0012805P1	170L7299	
Cooling fan	1	1	3ADT754006P1	RD23P-4DW.4I.1R	

Module contains: 2Q 4Q

24.10 DCSxxx-2000 (400V-500V) CONVERTER					
DESCRIPTION	2 Q	4 Q	CODE	TYPE/DATA	NOTES
Thyristor	6	12	DCA0012031P1	5STP18F1800	
Puls transformer board	1	2	3BSE004939R2	SDCS-PIN-48	former type SDCS-PIN-41 A
Power interface board	1	1	3BSE004940R1	SDCS-PIN-51	
Semiconductor fuses	6	6	3ADC770010P9	170M6166	former Id. Nr.DCA0012741P1
Cooling fan	1	1	3ADT754006P1	RD23P-4DW.4I.1R	

If you have any questions concerning spare parts, please contact your local ABB-agent!





# DC Drives Product Portfolio

## DCS 400

### The drive module for standard applications

- Integrated field supply (max. 20 A)
- Accurate speed and torque control
- Extremely small and compact design
- Very easy installation and commissioning
- Express delivery
- Power range: 10...500 kW (13...670 HP)



## DCS 500B / DCS 600

### The drive module for demanding applications

- Free programming of software
- 6- and 12-pulse configuration up to 10 MW/ 13,000 HP and more
- Plain text display
- Power range: 10...5000 kW (13...6700 HP)



## DCE 500 / DCE 600

### Highly integrated panel

- Excellent upgrade or revamp solution
- Contains:
  - DCS 500B / DCS 600 module
  - AC fuses
  - Auxiliary transformer
  - Motor fan starter with protection
  - Main contactor
- Power range: 10...130 kW (26...300 HP)



## DCS 400 / DCS 500 Easy Drive

### The complete standard cabinet solution

- Pre-engineered
- Easy installation and commissioning
- Protection class: IP 21
- Plain text display
- Short delivery time
- Power range: 50...1350 kW (65...1800 HP)



## DCA 500 / DCA 600

### For complex, completely engineered Drive System in common cabinet design

- Flexible and modular hardware structure
- 6- and 12-pulse configuration up to 18 MW/ 23,000 HP and more
- Pre-programmed applications: Metals, Cranes, P&P application, Mining
- Power range: 10...18000 kW (13...23000 HP)



ABB Automation Products GmbH  
 Postfach 1180  
 68619 Lampertheim • GERMANY  
 Tel: +49 (0) 62 06-5 03-0  
 Fax: +49 (0) 62 06-5 03-6 09  
 www.abb.com/dc



\*093R0801A5430000\*

Ident. No.: 3ADW 000 093 R0801 Rev H  
 11\_2005