USER GUIDE

MAN0151 Rev 5

NEXUS-3 Series



Style conventions used in this document:

UI Text: Text that represents elements of the UI such as button names, menu options etc. is presented with a grey background and border, in Tahoma font which is traditionally used in Windows UIs. For example:

Ok

Standard Terms (Jargon): Text that is not English Language but instead refers to industry standard concepts such as Strategy, BACnet, or Analog Input is represents in slightly condensed font. For example:

BACnet

Code: Text that represents File paths, Code snippets or text file configuration settings is presented in fixed-width font, with a grey background and border. For example:

```
$config_file = c:\CYLON\settings\config.txt
```

Parameter values: Text that represents values to be entered into UI fields or displayed in dialogs is represented in fixed-width font with a shaded background. For example

10°C

Product Names: Text that represents a product name is represented in bold colored text. For example

INTEGRA™

Company Brand names: Brands that are not product names are represented by bold slightly compressed text:

ABB Active Energy

PC Keyboard keys: Text representing an instruction to press a particular key on the keyboard is enclosed in square brackets and in bold font. For example:

[Ctrl]+[1]

1	OVERVIEW	
	NEXUS-3 Dimensions	5
	Front I/O	6
	Top I/O	6
	Bottom I/O	6
	Motherboard Features	7
	Serial Ports	8
	LEDs	8
	Ethernet Ports	9
2	INSTALLATION AND CONFIGURATION	
	Powering on the NEXUS-3 Series device	10
	Mounting Instructions	12
	DIN Rail Mounting	12
	Wall (Shock and Vibration) Mounting	12
3	SOFTWARE CONFIGURATION	
	Introduction	13
	Tools Required	13
	Connecting to a NEXUS-3 Series Device	13
	Log-In	14
	Control Panel	14
	Project Instances	15
	Calendar Configuration	15
	Users And Groups	16
	Instance Services	17
	Persistence Manager	17
	Project Source	18
	Project Removal	18
	Aspect Control Engine Log	18
	License Item Status	19
	Project Performance	19
	Database Management	20
	MySQL Administration	20
	SQLite Maintenance	21
	Licensing	21
	Communication Setup	22
	Out Of Service Manager (OSS)	22
	BACnet Settings	22
	BBMD Settings	23
	Modbus Network Properties	23
	Time Sync Settings	23
	System Administration	24
	User Manager	24
	System Services	24
	System Status	24
	Process Status	25
	System Updates	25
	OS Auto Update	26
	Backup/Restore	26
	Ethernet Settings	26
	Network Diagnostics	27
	Time Settings	27

- Web Server Configuration 28
- Image Proxy Configuration 28
- System Logs 29**
- Diagnostic Buffer 29
- Remote Logging 29
- System Log 30
- Update Log 30

1 Overview

This chapter provides an overview of the NEXUS-3 Series device system.

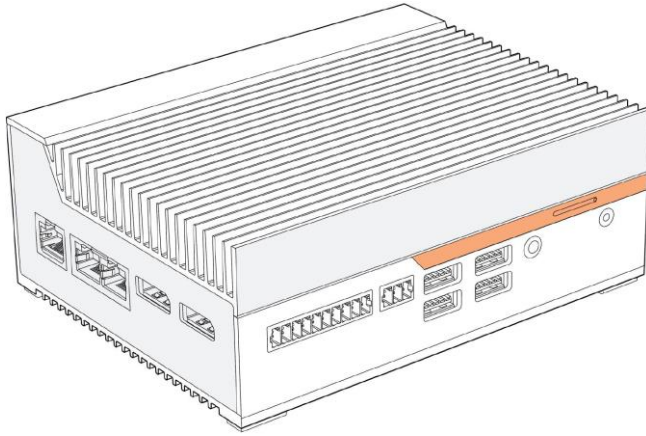

NEXUS-3 DIMENSIONS

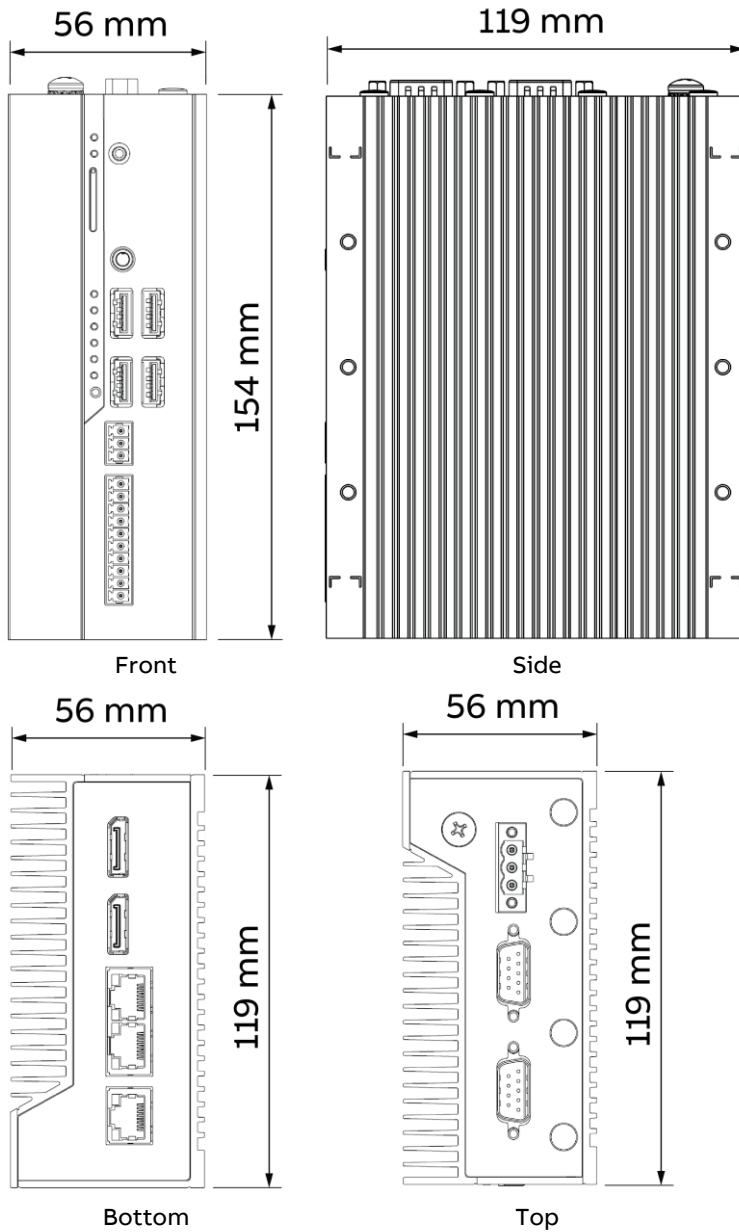

FRONT I/O

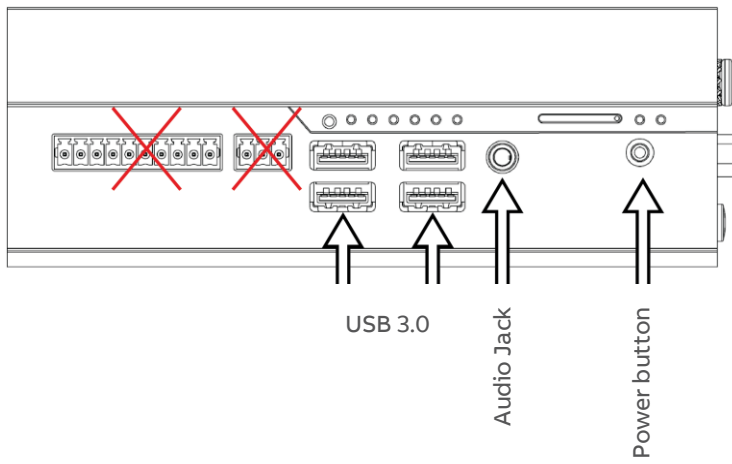

TOP I/O

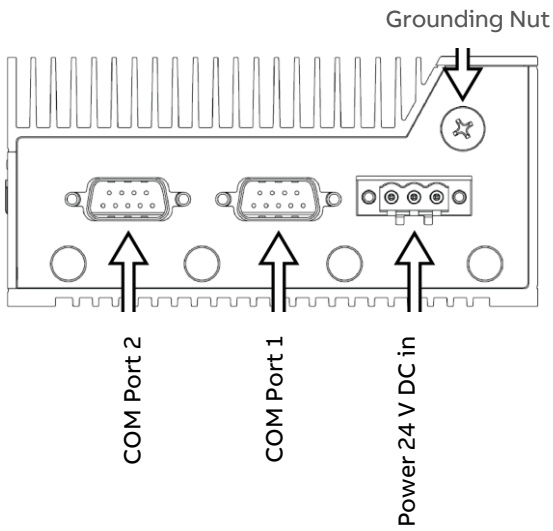

BOTTOM I/O

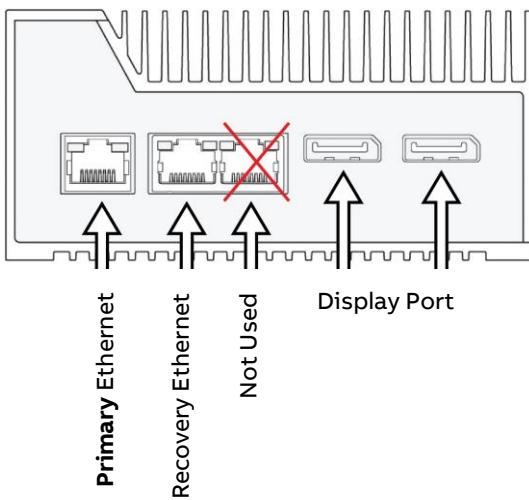

MOTHERBOARD FEATURES

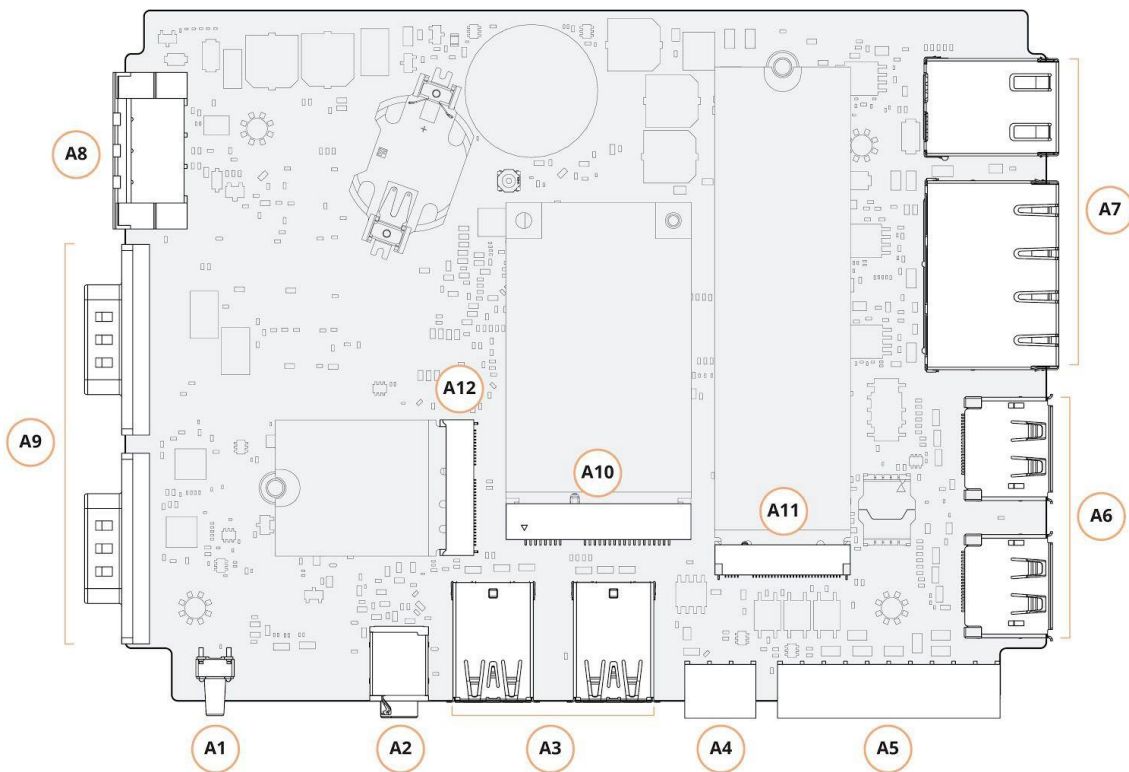

Item	Function Description
A1	Power button
A2	3.5 mm Audio jack
A3	4 x USB 3.0 Type A ports
A4	Not Used
A5	Not Used
A6	2 x Full-size DisplayPort
A7	1 x RJ45 GbE LAN port
	2 x RJ45 GbE LAN ports with optional PoE (30W total)
A8	3-pin power input (9 ~ 36 VDC)
A9	2 x Serial RS-232/422/485 ports
A10	Full-size mPCIe
A11	M.2 2280 M-key for NVMe or SATA storage
A12	M.2 2230 E-key for Wi-Fi or WAN card

SERIAL PORTS

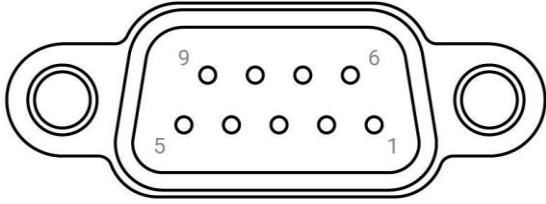
	Pin	RS-232	RS-422	RS-485
	1	DCD	TX-	TX-/RX-
	2	RX	TX+	TX+/RX+
	3	TX	RX+	NC
	4	DTR	RX-	NC
	5	GND	NC	NC
	6	DSR	NC	NC
	7	RTS	NC	NC
	8	CTS	NC	NC
	9	RI	NC	NC

NC = Not Connected

LEDS

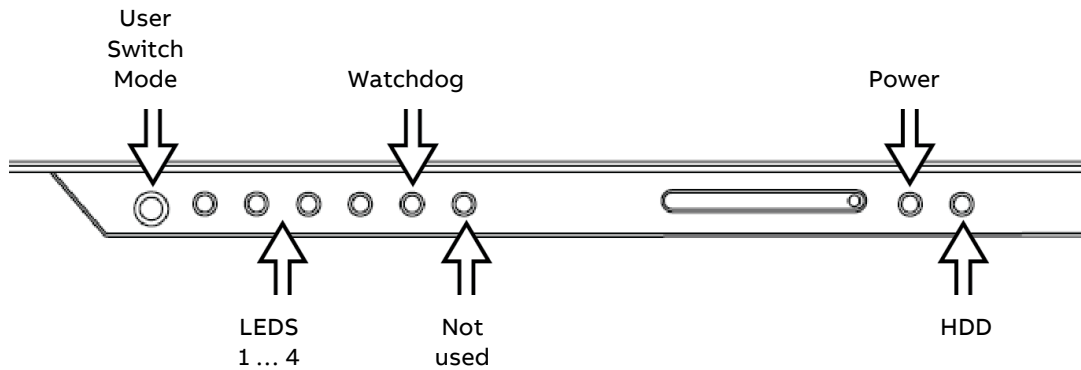

LED	On	Off	Blink	Pulse
HDD	-	-	Internal storage drive activity	-
Power	Device is on	Device is off	Device is asleep	-
Watchdog	Internal MCU is not functioning normally	Internal MCU is functioning normally	Firmware bootloader is active	Internal MCU is functioning normally
LEDs 1-4	Currently selected user mode	-	-	-

ETHERNET PORTS

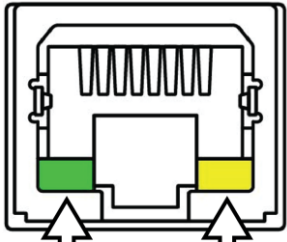
	LED	Color	State	Condition
 <p>Link LED (Green)</p> <p>Speed LED (Green/Yellow)</p>	Link	-	Off	LAN link is not established
		Green	On	LAN link is established
			Blinking	LAN activity occurring
	Speed	-	Off	10 Mb/s data rate
		Green	On	100 Mb/s data rate
		Yellow	On	1000 Mb/s data rate

2 Installation and configuration

Note: The information in this chapter provides an overview of the installation and configuration requirements of the NEXUS-3 Series device. The NEXUS-3 Series device is designed for specific applications and needs to be installed by qualified personnel with RF and regulatory-related knowledge.

POWERING ON THE NEXUS-3 SERIES DEVICE

1. Install the NEXUS-3 Series device on the wall mount using a wall mounting kit, or Install the NEXUS-3 Series device on the rack infrastructure using DIN-rail mounting brackets.
2. Connect a network cable.
3. Connect the supplied PSU to the NEXUS-3 Series device

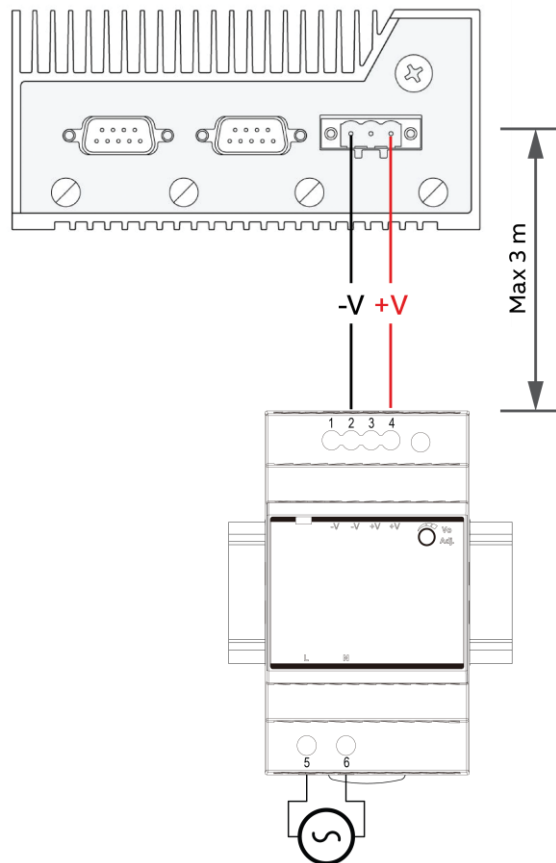

4. Press the power button to turn it on.

Note: For warranty purposes it is recommended that only the included power supply should be used with NEXUS-3 Series devices.



Warning: NEXUS-3 can be powered by a 24 V DC supply only.
The device will be damaged if connected to a 24 V AC power source.

- Attach the supplied DB9-to-screw-terminal adapters to the two COM ports.

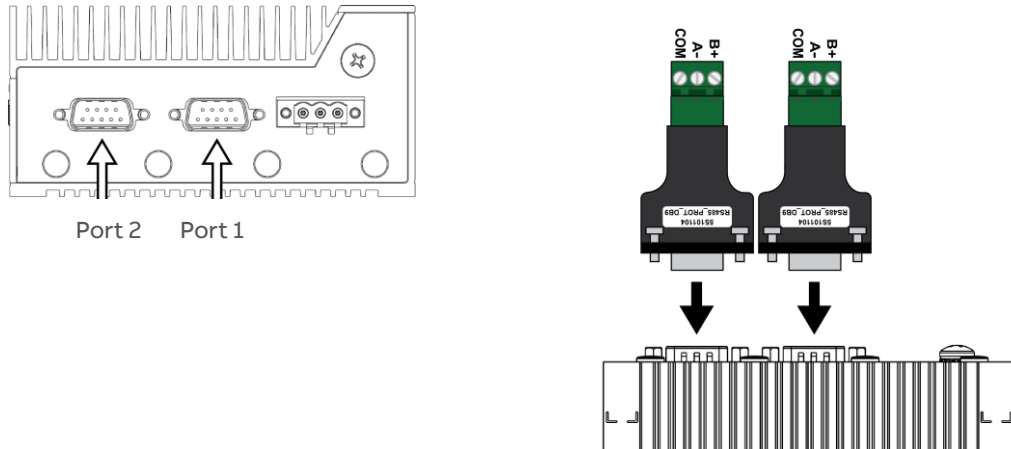

Note: For consistency with legacy NEXUS 2 hardware, the Screw Terminals are labelled above in a different way to Cylon BACnet devices (FBXi, CBXi and CBX controllers). The “-” pin is labelled “A” and the “+” pin is labelled “B”.

On Cylon BACnet devices The “-” pin is labelled “B” and the “+” pin is labelled “A”.

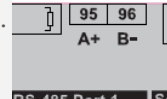

- Connect and configure devices using the RS485 ports.

MOUNTING INSTRUCTIONS

DIN RAIL MOUNTING

Step 1: Attach wall mounting brackets to the chassis

Step 2: Attach DIN Rail mounting brackets to the chassis

Step 3: Clip system to the DIN Rail

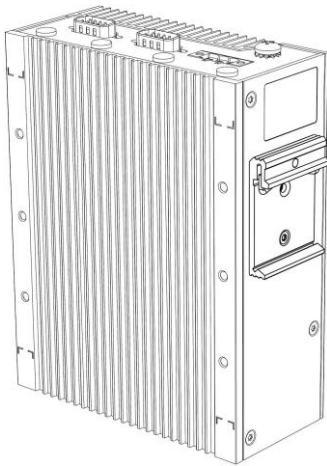

DIN Rail Edge Mounting

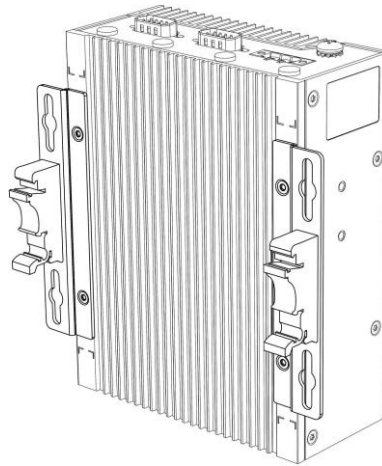

DIN Rail Back Mounting

WALL (SHOCK AND VIBRATION) MOUNTING

Step 1: Attach wall mounting brackets to the chassis

Step 2: Mark and prep holes in surface for mounting

Step 3: Fasten system to surface

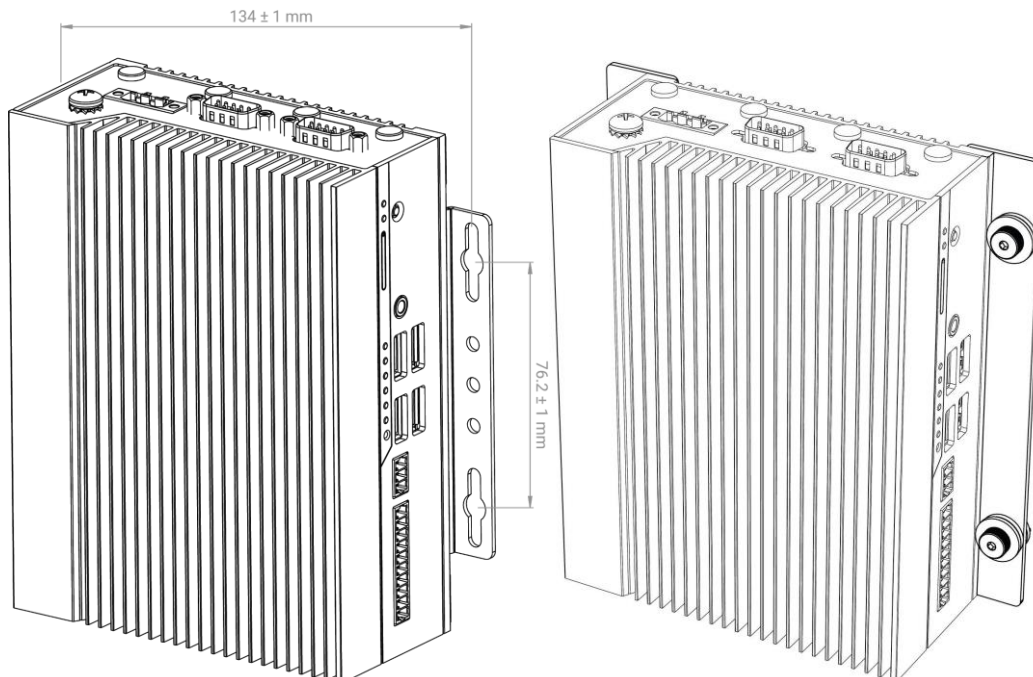

3 Software Configuration

INTRODUCTION

The following provides details on the software configuration of the NEXUS-3 Series hardware. Please follow the steps contained within this section for proper setup and configuration.

TOOLS REQUIRED

The following tools will be required for proper configuration of the system:

- PC/Laptop
- Ethernet cross-over cable, or other network connection to your NEXUS-3 Series device
- Standard web-browser such as Windows Edge, Mozilla Firefox, Apple Safari, or other.
- NEXUS-3 Series License file pre-installed

CONNECTING TO A NEXUS-3 SERIES DEVICE

The NEXUS-3 Series device is shipped with a default IP address (192.168.1.251) and subnet mask (255.255.255.0) on the primary Ethernet Port.

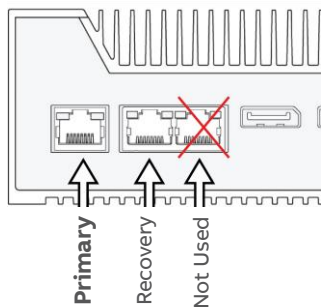

Your laptop's network card must be configured in a manner where it may access this IP network setting. Refer to your operating system documentation for details on how to configure your network card.

See *Ethernet Settings* on page 26 for details on how to reconfigure NEXUS-3 Series device IP Address.

Note: The recovery Ethernet Port is configured with a default IP address (192.168.1.250) and subnet mask (255.255.255.0), so that if connectivity is lost on the primary LAN port, you can use the recovery port to gain access to the NEXUS-3 Series controller as described below and reset it.

Primary and Recovery ports should not be both connected at the same time – unplug the primary port when connecting your laptop to the recovery port.

To use the recovery port:

- Depending on your Operating System, set your Network Adaptor to the 192.168.1.0/24 IP network. e.g. in Windows, in **Settings > Network & Internet** set the IP address to 192.168.1.1 and Subnet Mask to 255.255.255.0 (i.e. the default value).
- You should now be able to reach <http://192.168.1.250/> in a browser on your PC and proceed from there. (If you have HTTPS enabled, you can reach the target at <https://192.168.1.250/> instead.)
- Once recovery is complete, the NEXUS-3 Series device must be rebooted.

LOG-IN

To log-in to the NEXUS-3 Series device:

1. With your PC's network card configured, open any standard web browser.
2. Browse to the IP address of your NEXUS-3 Series device as defined during installation.
3. If your connection is successful, the main login page of ASPECT will be displayed:

The screenshot shows a simple login interface with a light gray background. It features two white input fields: the top one is labeled 'Username' and the bottom one is labeled 'Password'. Below these fields is a small button with the text 'Log In'.

4. Enter the case-sensitive default username and password into the fields provided.
5. Click the **Log In** button.

CONTROL PANEL

When you successfully log-in, you will be directed to the Control Panel. The Control Panel contains a navigation tree to the left of the web user interface; allowing users to select different configuration areas of the product.

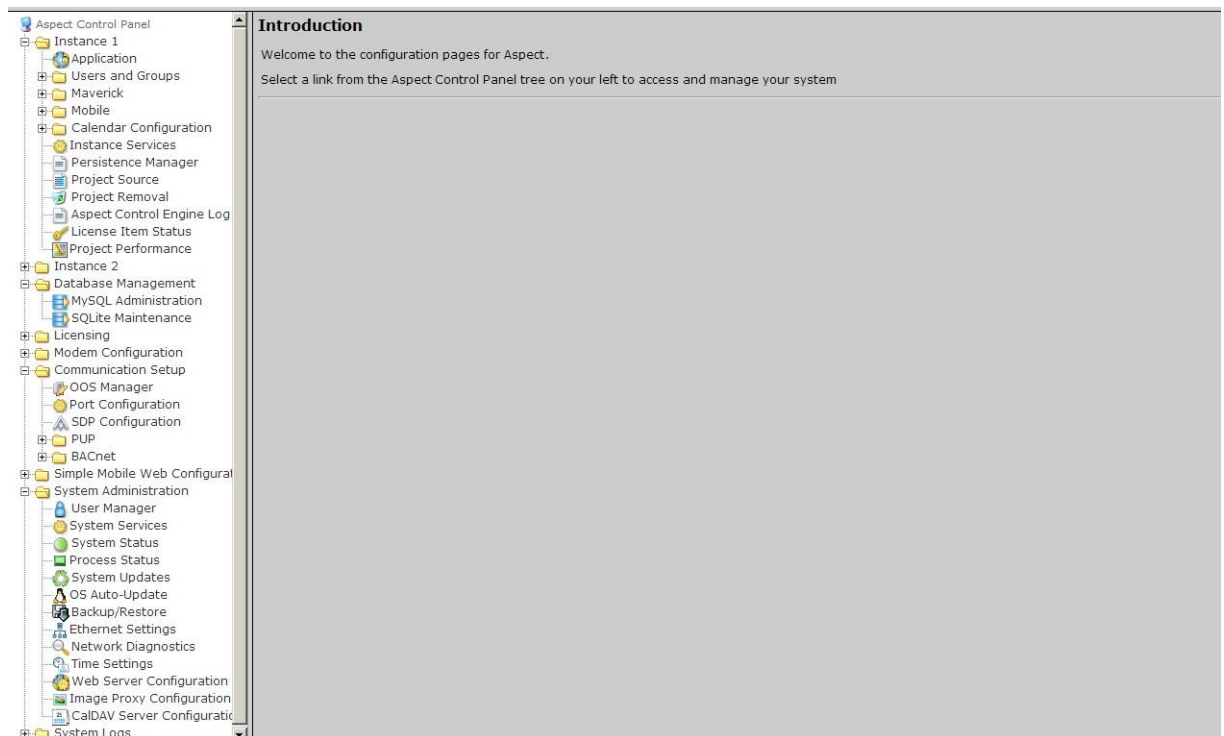

PROJECT INSTANCES

Two instances are available within the NEXUS-3 Series device. This provides the capability to host up to two projects within the target. Each instance runs its own Aspect Control Engine allowing service to be performed on separate instances. Within Instance 1 and Instance 2, the same options exist for the following:

- Calendar Configuration
- Users and Groups
- Mobile
- Instance Services
- Project Source
- Project Removal
- Aspect Control Engine Logs
- License Item Status
- Project Thread Status

CALENDAR CONFIGURATION

The Calendar Configuration area is used to configure iCalendar integration variables of the NEXUS-3 Series device. Within this section there are two pages:

- Calendar File
- Calendar User

Calendar File

Calendar File can be used to browse and modify what calendars have been previously published to the instance, as well as allow users to manually upload iCalendar files (files with .ics extensions) to the device.

- To upload a saved calendar file, simply select the Browse/Choose File button and locate the iCalendar file on your computer. Once located, click the Upload button.
- To delete a previously published calendar, place a check mark next to the corresponding file and select the Delete button.

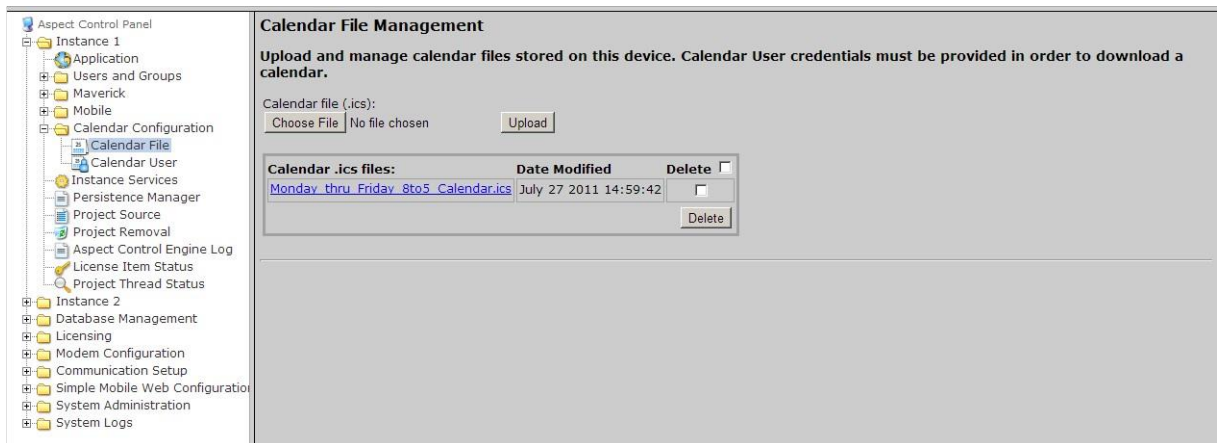

Calendar User

Calendar User provides the ability to change the default username and password credentials that are required to allow iCalendar-based tools to publish data to the **NEXUS-3 Series** device. By default, the username (*calendar*) and password (*user*) can be changed to any desired credential set. When referencing Calendars in Aspect Studio, these credentials must be specified in order to properly access the file.

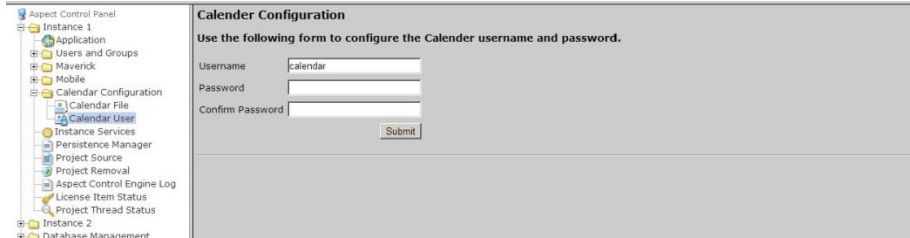

USERS AND GROUPS

Users and Groups are included within each instance in the **NEXUS-3 Series** device. This provides the ability to manage users in the Aspect control instance it serves.

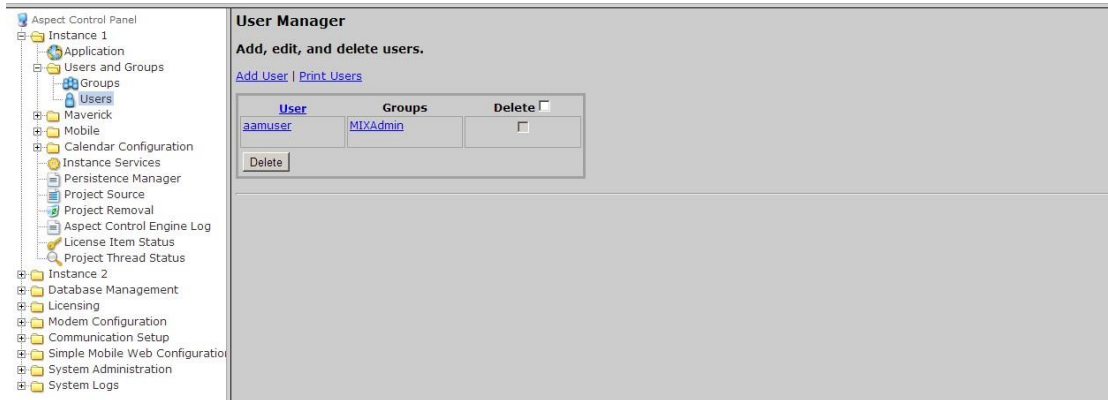

INSTANCE SERVICES

The Instance Services provides users with the ability to restart the Aspect Control Engine for the instance they are working with. Only one option is available in the Instance Services drop-down which will allow the instance to be reset.

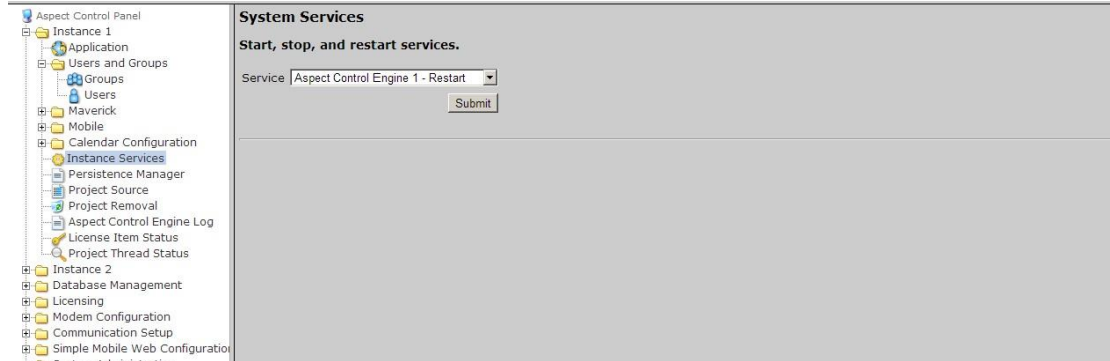

PERSISTENCE MANAGER

The Persistence Manager area is used to manage and delete Persisted data. Persisted data is localized data stored from Persisted Elements that may be present in an Aspect project, as well as data persisted by vSTAT elements when such functionality is implemented in a delivered solution.

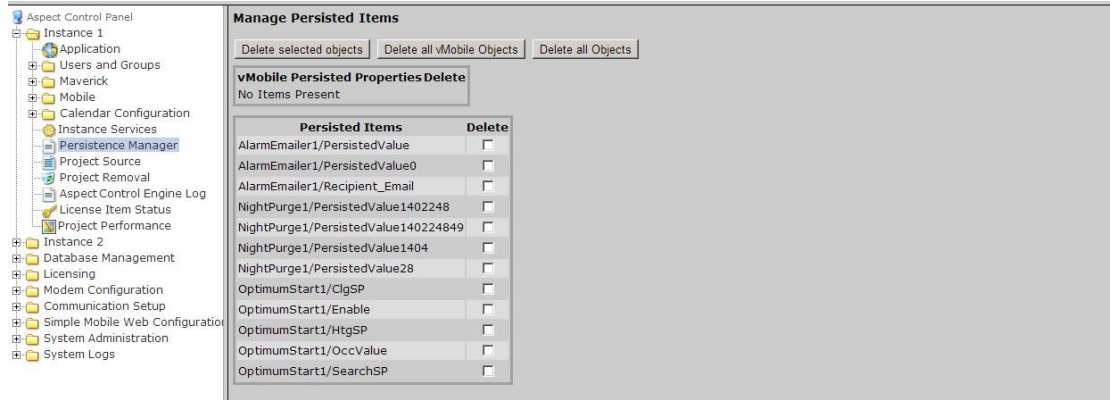

PROJECT SOURCE

The Project Source page provides administrators with the ability to download a password protected copy of the Aspect project deployed to the Instance. When selecting this in the Control Panel, you will be prompted to re-enter your credentials in order to download a copy of the project.

The required credentials will be the same as the ones used to originally deploy the project.

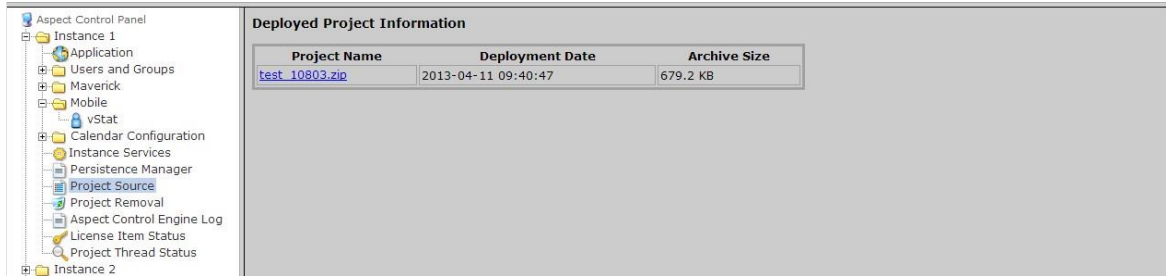

PROJECT REMOVAL

The project removal page provides administrators the ability to remove a currently deployed project from an Aspect instance.

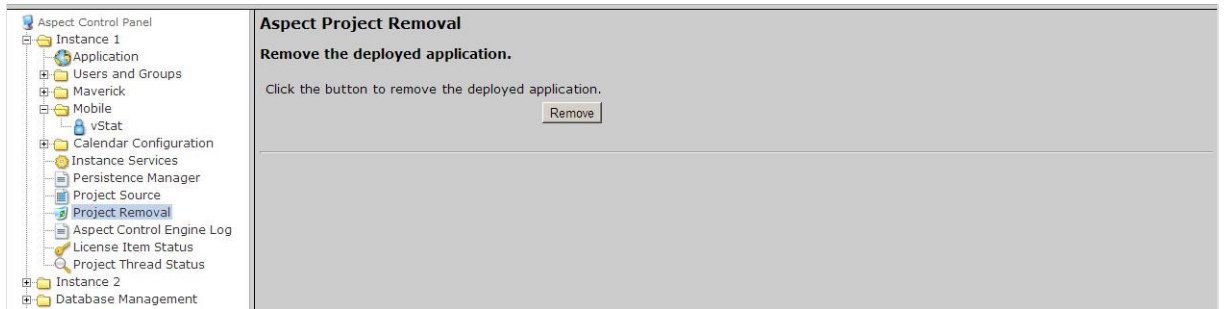

ASPECT CONTROL ENGINE LOG

The Aspect Control Engine log provides administrators and technicians the ability to view project status and debugging information relating to the health of the deployed Aspect project. Up to 10 pages of Aspect logs are contained and individual logs can be downloaded.

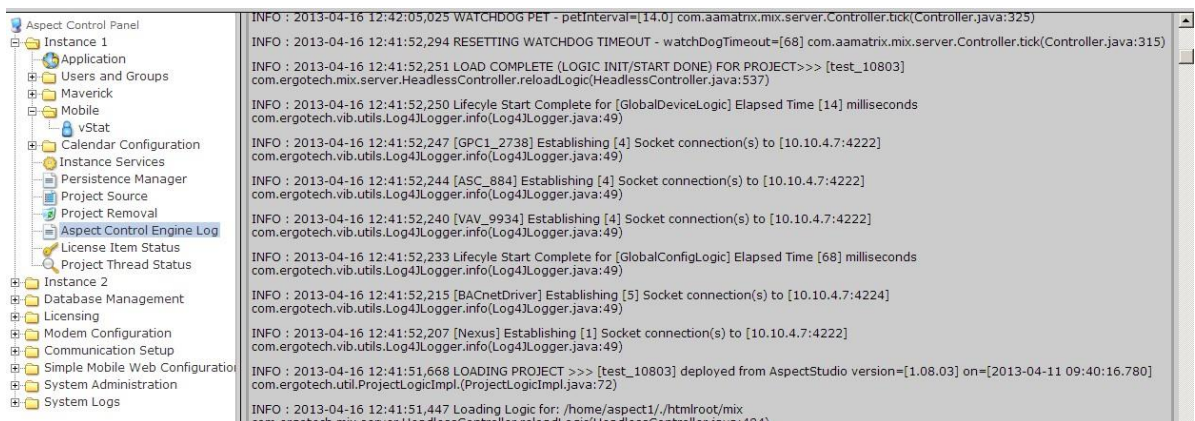

LICENSE ITEM STATUS

The License Item Status area provides the ability to view how many current license items a project may be using, as well as the maximum amount of licenses available for a particular feature or function.

Instance License Status:

Token	Current	Max
ModbusRTUDevice	0	64
LicensedDevices	64	64
BACnetIPDevice	0	64
VStat	0	128
FTNetDevice	1	999999
LicensedPoints	1247	4000
ModbusIPDevice	0	64
UnitronNetwork	0	4096
PupDevice	0	64
BACnetDevice	0	64
FT	1	2
LicensedAamnet	1	999999
SdpDevice	0	0

PROJECT PERFORMANCE

The Project Performance area provides the ability to dynamically view and monitor the status of Threads, Maps, and Ports being used by the Aspect project loaded into the target.

By default, the all Tabs will update information every 15 seconds. You may adjust this update timer by choosing the Settings tab, and changing the Global Settings Update time.

Thread Status at 13:32:07 GMT-0400 (Eastern Daylight Time)
 Total Timers: 9
 Total Targets: 30

Timebase	Target Class	HashCode	Target Count	ElapsedTime (ms)	Last Tick Time (s)	Load
60.0	Schedule	1082029522	1	163	59.4s ago	0.27%
14.0	Default	1288520654	1	19	3.7s ago	0.14%
1.0	Default	1579795854	12	1	0.3s ago	0.10%
2.0	Default	453897055	4	1	0.3s ago	0.05%
15.0	Schedule	1602698930	1	2	2.8s ago	0.01%
3600.0	Default	1511627065	2	0	2013.2s ago	0.00%
600.0	Default	1192380230	3	0	231.6s ago	0.00%
300.0	Default	1725603492	3	1	129.2s ago	0.00%
15.0	Default	1877445782	3	0	5.6s ago	0.00%

DATABASE MANAGEMENT

Database Management is the centralized location for all database storage and contains paths to MySQL Administration and SQLite Maintenance.

MYSQL ADMINISTRATION

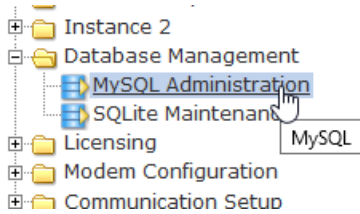

The **MySQL Administration** item in the webUI tree links to an administration interface for ASPECT's MySQL Database Server. To access the Database Interface, the user must enter (case sensitive) login credentials. The default credentials are:

- Username - **matrixac1**
- Password - **aam**

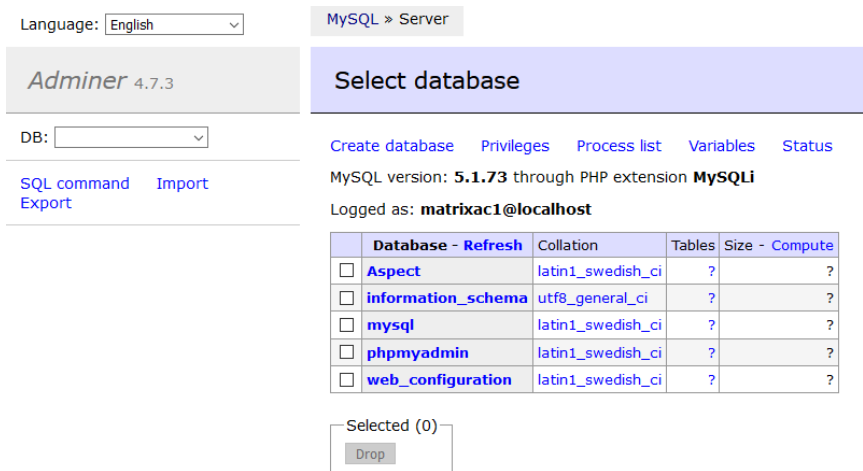

Note: MySQL administration in ASPECT 3.03.02 and later uses Adminer. However, on devices running 3.03.01 or earlier the UI for MySQL administration is based on phpMyAdmin:

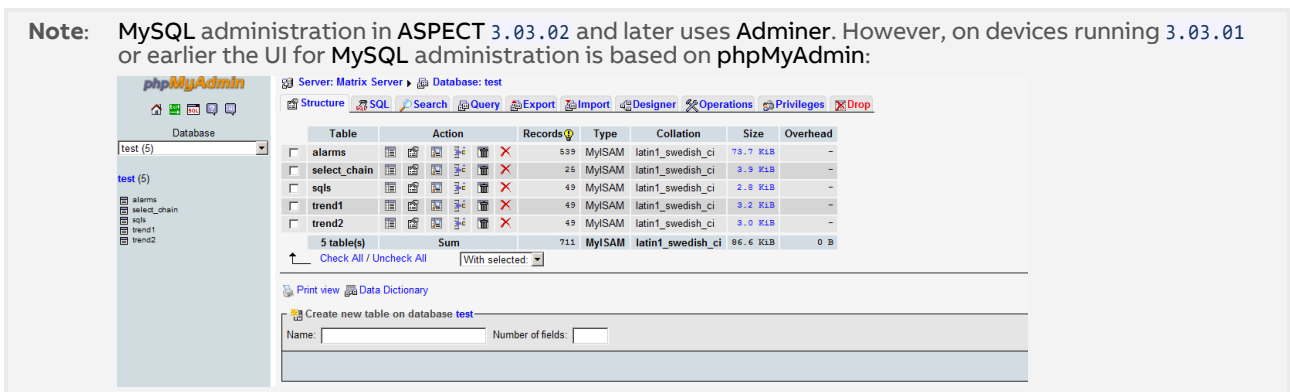

SQLITE MAINTENANCE

The **SQLite Maintenance** page provides users with the ability to manage the **SQLite** database. This page shows the database files and sizes.

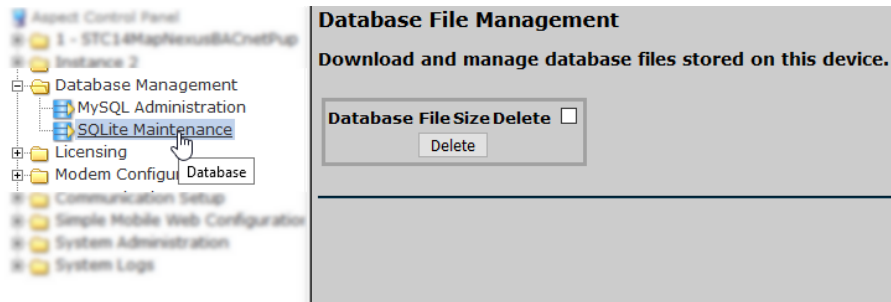

LICENSING

The **License** page provides the ability to view the current license status of the **NEXUS-3 Series** device as well as a method to upload/download license files. If a license file is uploaded, Cylon Controls recommends rebooting the **NEXUS-3 Series** device to ensure the license file is successfully applied.

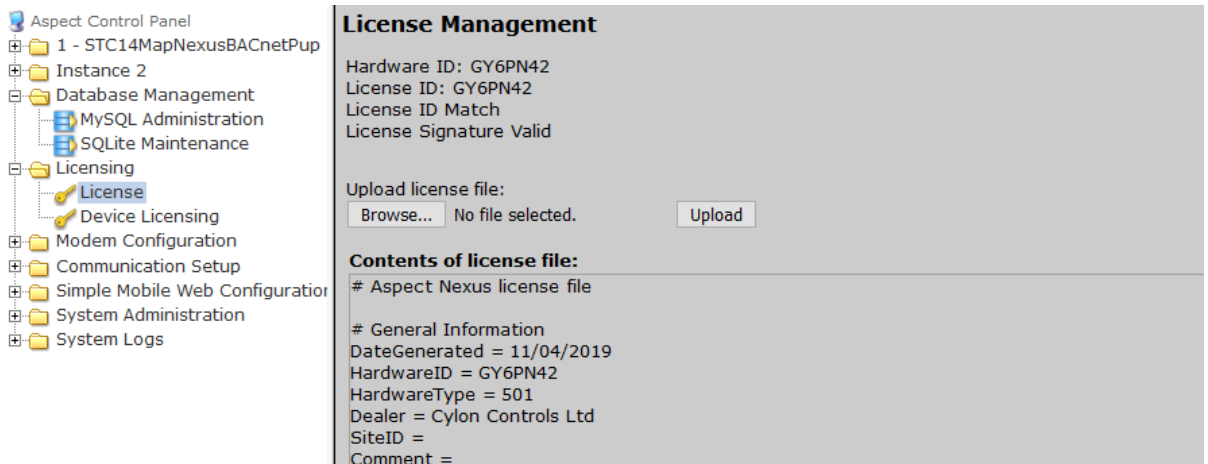

COMMUNICATION SETUP

The **Communication Setup** page provides administrators the ability to configure manual Out of Service entries, SDP Network Properties, BACnet IP Router, BBMD and Time Synchronization settings.

OUT OF SERVICE MANAGER (OSS)

The **Out Of Service Manager (OSS)** provides a single location that allows administrators to manually mark devices out of service using the Manual OOS check boxes.

The screenshot shows the 'Commit OOS Settings' page. On the left is a navigation tree with 'OOS Manager' selected. The main content area has two sections:

PUP Devices

Device	Last Transaction	OOS	Manual OOS
Line:0 ID:11305	60s		<input type="checkbox"/>
Line:0 ID: 64	60s		<input type="checkbox"/>
Line:0 ID: 100	60s		<input type="checkbox"/>
Line:0 ID: 9934	60s		<input type="checkbox"/>
Line:0 ID:15163	60s		<input type="checkbox"/>

BACnet Devices

Device	Last Transaction	OOS	Manual OOS
Network: 3691 ID:0.0.0.0:14	46s		<input checked="" type="checkbox"/>
Network: 3691 ID:0.0.0.0:5	1s		<input type="checkbox"/>

BACNET SETTINGS

The **BACnet Configuration** area allows configuration of read/write retries, port configuration, and router settings for BACnet/IP.

The screenshot shows the 'BACnet Configuration' page. On the left is a navigation tree with 'BACnet Settings' selected. The main content area contains several configuration sections:

BACnet IP Configuration

- UDP Port: 47808
- IP Timeout (seconds): 0.5
- IP Write Retries: 1
- IP Read Retries: 1
- IP Out Of Service Time (seconds): 60
- IP Discovery Timeout (seconds): 3

BACnet MSTP Configuration

- MSTP Timeout (seconds): 1.0
- MSTP Write Retries: 1
- MSTP Read Retries: 1
- MSTP Out Of Service Time (seconds): 60

BACnet Router Configuration

- Device Name: NexusX
- BACnet Device Instance Number: 541
- BACnet Ethernet Enabled: No
- BACnet IP Enabled: Yes
- BACnet IP Network Number: 555
- BACnet Internal Network Number: 2651
- BACnet NAT Network Enabled: No
- Router Debug Level: 1
- BACnet Debug Level: 1

A 'Submit' button is located at the bottom right of the configuration area.

BBMD SETTINGS

The **BBMD settings** area is used to configure the BACnet/IP Broadcast Management Device (BBMD) table setup for BACnet networks.

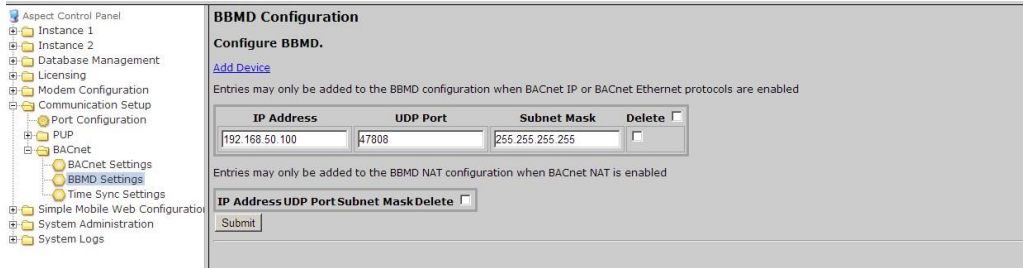

MODBUS NETWORK PROPERTIES

The **Modbus Network Properties** page is used to set the configuration for Modbus communications.

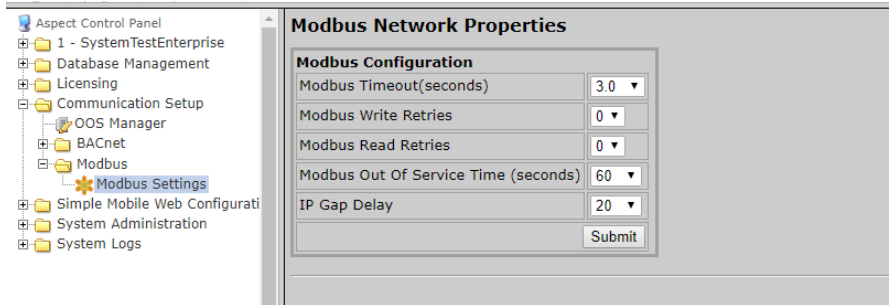

TIME SYNC SETTINGS

The **Time Sync Settings** area provides the ability to configure BACnet network time synchronizations.

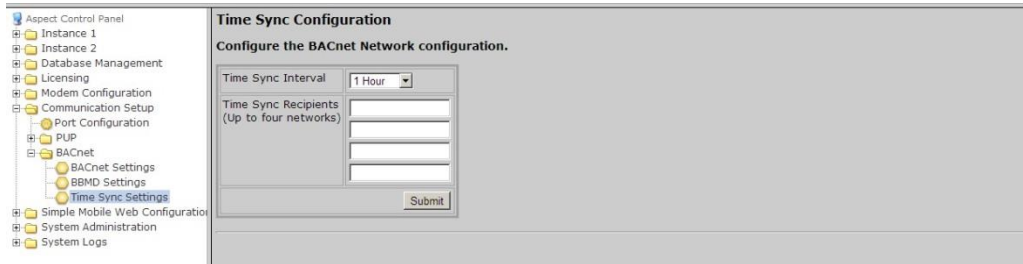

SYSTEM ADMINISTRATION

The System Administration area contains system settings for the NEXUS-3 Series device. These fields include the User Manager, System Services, System Status, System Updates, Ethernet Settings, Time Settings Web Server Configuration, Process Status, Image Proxy Configuration, and CalDAV Server Configuration.

USER MANAGER

The User Manager area provides fields to setup, add and remove administrative users from the NEXUS-3 Series device. Administrative users are granted full access to the Aspect Control Panel while users/groups created within an instance are only allowed access to deployed projects.



SYSTEM SERVICES

The System Services area provides administrators with the ability to control key services relative to the target. Through this area, users can restart specific services of the NEXUS-3 Series device. Simply select an option from the drop-down and click Submit. A message will indicate that the service has been stopped/started/restarted successfully.

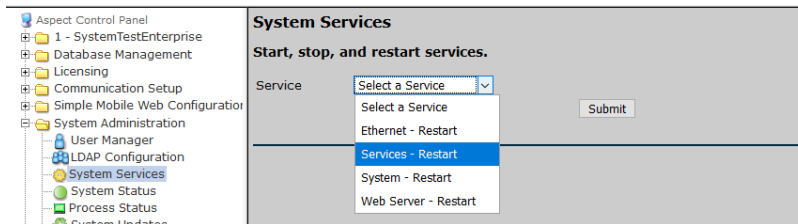

SYSTEM STATUS

The System Status page provides details on the current health of the system including Uptime, memory (RAM) utilization, disk space and all information pertaining to revision levels.

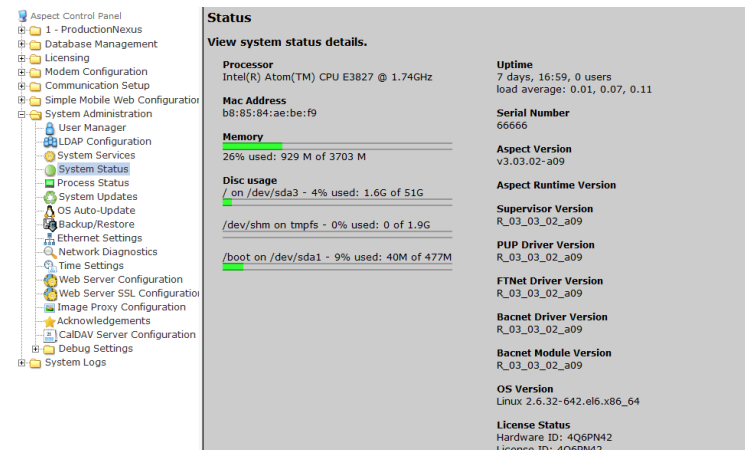

PROCESS STATUS

This shows the result of a top command which produces an updating list of current processes running.

```

top - 15:46:11 up 3 days, 2:45, 0 users, load average: 0.03, 0.02, 0.00
Tasks: 150 total, 1 running, 149 sleeping, 0 stopped, 0 zombie
Cpu(s): 0.1%us, 0.3%sy, 0.0%ni, 99.4%id, 0.1%wa, 0.0%hi, 0.0%si, 0.0%st
Mem: 1912684k total, 1089852k used, 822832k free, 146460k buffers
Swap: 2097144k total, 0k used, 2097144k free, 282172k cached

  PID USER   PR  NI  VIRT  RES  SHR  S  %CPU  %MEM  TIME+  COMMAND
 19533 apache  20   0 15028 1120  820  R   3.8   0.1   0:00.04  top
 2241  root   20   0 1468m 3116  700  S   1.9   0.2   74:12.41  mix-com-srv
   1   root   20   0 19352 1528 1220  S   0.0   0.1   0:02.04  init
   2   root   20   0  0      0     0  S   0.0   0.0   0:00.01  kthreadd
   3   root   RT   0  0      0     0  S   0.0   0.0   0:00.31  migration/0
   4   root   20   0  0      0     0  S   0.0   0.0   0:00.99  ksoftirqd/0
   5   root   RT   0  0      0     0  S   0.0   0.0   0:00.00  migration/0
   6   root   RT   0  0      0     0  S   0.0   0.0   0:00.36  watchdog/0
   7   root   RT   0  0      0     0  S   0.0   0.0   0:00.31  migration/1
   8   root   RT   0  0      0     0  S   0.0   0.0   0:00.00  migration/1
   9   root   20   0  0      0     0  S   0.0   0.0   0:01.97  ksoftirqd/1
  10   root   RT   0  0      0     0  S   0.0   0.0   0:00.39  watchdog/1
  11   root   RT   0  0      0     0  S   0.0   0.0   0:00.34  migration/2
  12   root   RT   0  0      0     0  S   0.0   0.0   0:00.00  migration/2
  13   root   20   0  0      0     0  S   0.0   0.0   0:01.80  ksoftirqd/2
  14   root   RT   0  0      0     0  S   0.0   0.0   0:00.34  watchdog/2
  15   root   RT   0  0      0     0  S   0.0   0.0   0:00.32  migration/3
  16   root   RT   0  0      0     0  S   0.0   0.0   0:00.00  migration/3
  17   root   20   0  0      0     0  S   0.0   0.0   0:01.75  ksoftirqd/3
  18   root   RT   0  0      0     0  S   0.0   0.0   0:00.36  watchdog/3
  19   root   20   0  0      0     0  S   0.0   0.0   0:22.84  events/0
    
```

SYSTEM UPDATES

The System Updates area is used to perform firmware upgrades to the ASPECT device. These firmware updates can be obtained from the ABB Cylon Toolbox / Support Site.

Update System - Confirm

CAUTION: Please be aware that the Aspect Control Engine will be shut down once you click continue.

It is recommended to download a **Configuration Backup** using [Backup/Restore](#) before applying updates.

Click "Continue" to proceed to upload stage.

Clicking on the **Continue** button opens the upload page:

Update System - File Upload

Upload the ".aam" file and then submit the form to execute the system update.

Update Aspect: No file chosen

OS AUTO UPDATE

Permits whether to allow or disallow automatic YUM updates. It is recommended that this setting be left at “Enabled”.

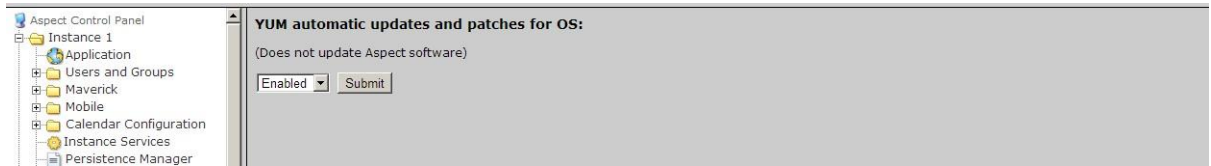

BACKUP/RESTORE

Backup /Restore provides the means to backup an ASPECT target's device configuration (network addresses, port and driver configuration, etc). To create a backup, simply click the Download button.



ETHERNET SETTINGS

The Ethernet Settings area permits for Ethernet address configuration of the NEXUS-3 Series device. The NEXUS-3 Series device can support static IP addresses or DHCP addressing from a valid DHCP server. Simply select the appropriate address setting for your application.

- To configure the device to use DHCP addressing, select the Obtain an IP Address Automatically radio button. In most DHCP environments, a resolvable DNS name or reserved IP address is assigned to the NEXUS-3 Series device by the local network administrator prior to configuring the device for this option.
- To configure the device to use a static IP address, select the Use the following IP Address radio button, then enter your IP address, Subnet Mask, Gateway, and DNS information into the boxes provided below.

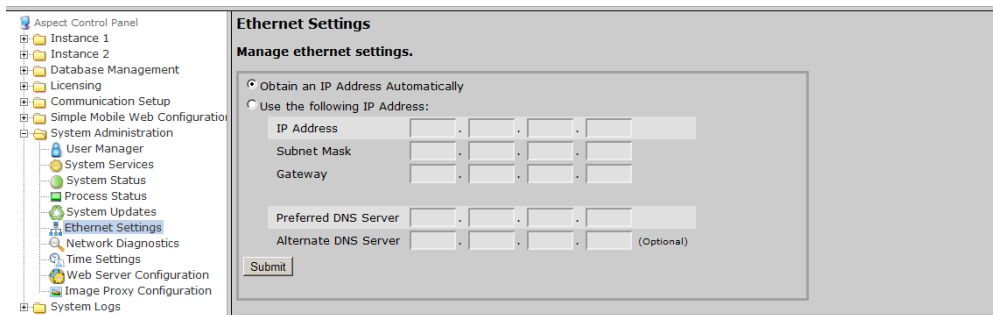

NETWORK DIAGNOSTICS

The **Network Diagnostics** area contains useful troubleshooting methods for network connectivity problems without the need for additional tools.

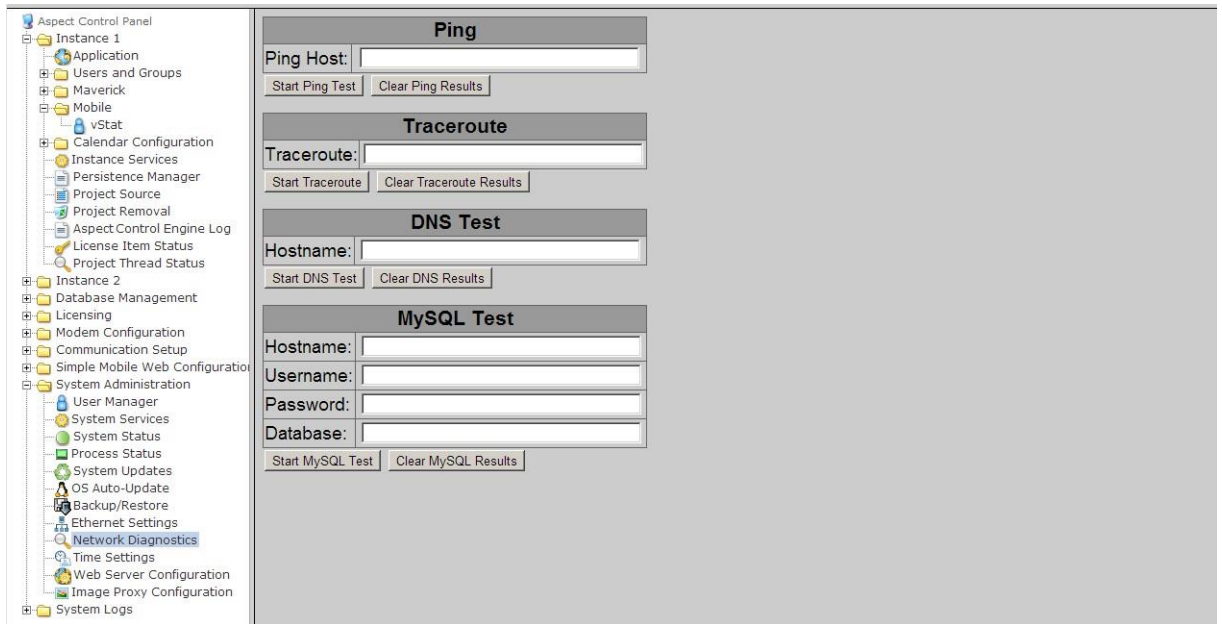

TIME SETTINGS

The Time Settings area allows users to configure the **NEXUS-3 Series device** Time and Date parameters. In this section, users can set the following items using the appropriate drop-downs and editors:

- System Time - specified in military time
- System Date - specified in MM/DD/YYYY
- TimeZone/Region - specified in one of many configurable options
- Time Server Synchronization - Specifies an NTP time server on the Internet with which to sync the system time to. Refer to pool.ntp.org for information relative to other available NTP servers available.

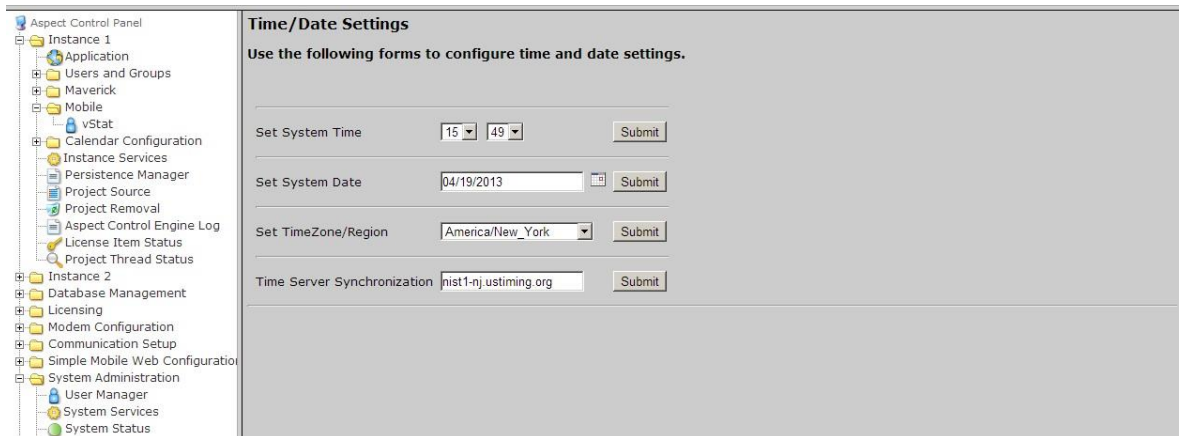

WEB SERVER CONFIGURATION

The Web Server Configuration area is used to set a label for the login screen and change port settings for the following:

- Aspect Control Panel - defaults to port 80(HTTP)
- Aspect Control Engine - defaults to port 7226
- Simple Mobile Web - defaults to port 8080

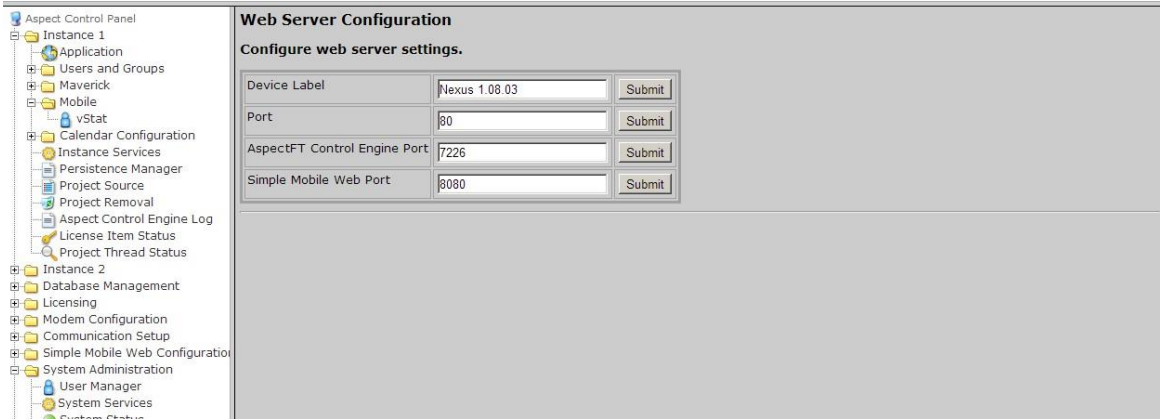
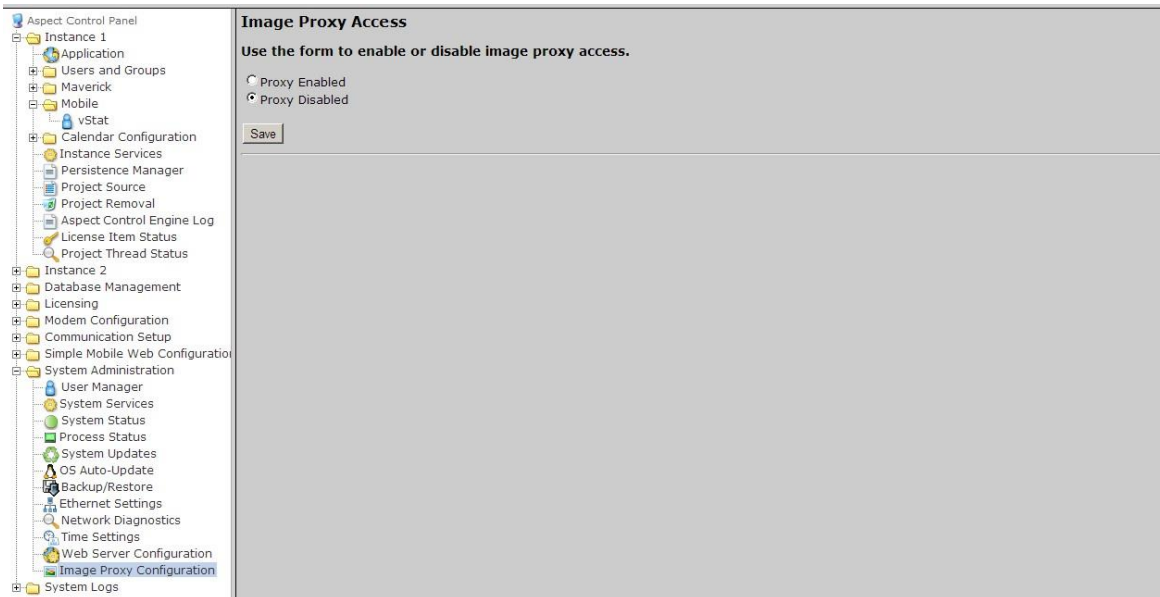

IMAGE PROXY CONFIGURATION

The Image Proxy Configuration page permits users to enable or disable image proxy, allowing Aspect to access external sites retrieve graphics.



SYSTEM LOG

The System Log area provides complete syslog information for the hardware. Information provided within this log includes boot up details and lower level information regarding runtime of the system.

UPDATE LOG

The update log shows all recent updates to the operating system.

Update Log

View Package Update Logs

yum.log

[Download the update log](#)

Apr 17 05:17:56	Updated: krb5-libs-1.10.3-10.el6_4.2.x86_64
Apr 06 04:50:35	Updated: coreutils-8.4-19.el6_4.1.x86_64
Apr 06 04:50:31	Updated: coreutils-libs-8.4-19.el6_4.1.x86_64
Mar 29 05:06:12	Updated: 32:bind-utils-9.8.2-0.17.rc1.el6_4.4.x86_64
Mar 29 05:06:12	Updated: 32:bind-libs-9.8.2-0.17.rc1.el6_4.4.x86_64
Mar 28 12:03:55	Updated: tzdata-2013b-1.el6.noarch
Mar 28 12:03:44	Updated: tzdata-java-2013b-1.el6.noarch
Mar 28 12:03:40	Updated: pixman-0.26.2-5.el6_4.x86_64
Mar 28 12:03:40	Updated: 4:perl-Time-HiRes-1.9721-130.el6_4.x86_64
Mar 28 12:03:40	Updated: 1:perl-Digest-SHA-5.47-130.el6_4.x86_64
Mar 28 12:03:40	Updated: perl-Archive-Tar-1.58-130.el6_4.x86_64
Mar 28 12:03:39	Updated: 1:perl-Package-Constants-0.02-130.el6_4.x86_64
Mar 28 12:03:39	Updated: 1:perl-IO-Zlib-1.09-130.el6_4.x86_64
Mar 28 12:03:39	Updated: perl-Compress-Zlib-2.020-130.el6_4.x86_64

This page is intentionally blank



—
ABB CYLON CONTROLS

Clonshaugh Business &
Technology Park
Clonshaugh
Dublin 17
Ireland

Tel.: +353 1 245 0500
Fax: +353 1 245 0501
Email: info@cylon.com

—
ABB CYLON CONTROLS

ONE TECHNOLOGY LANE
EXPORT,
PA 15632

Tel.: +1 724 733-2000
Fax: +1 724 327-6124