

5SNA 1800E330400

HiPak IGBT module



- $V_{CE} = 3300\text{ V}$
- $I_C = 1800\text{ A}$
- Ultra-low loss TSPT+ technology
- Very soft switching FCE diode with increased diode area
- Exceptional ruggedness and highest current rating
- AISiC base-plate for high power cycling capability
- AlN substrate for low thermal resistance
- Recognized under UL1557, File E196689

Maximum rated values ¹⁾

Parameter	Symbol	Conditions	min	max	Unit
Collector-emitter voltage	V_{CES}	$V_{GE} = 0\text{ V}, T_{vj} \geq 25\text{ °C}$		3300	V
		$V_{GE} = 0\text{ V}, T_{vj} = -40\text{ °C}$		3000	
DC collector current	I_C	$T_C = 98\text{ °C}, T_{vj} = 150\text{ °C}$		1800	A
Peak collector current	I_{CM}	$t_p = 1\text{ ms}$		3600	A
Gate-emitter voltage	V_{GES}		-20	20	V
DC forward current	I_F			1800	A
Peak forward current	I_{FRM}	$t_p = 1\text{ ms}$		3600	A
Surge current	I_{FSM}	$V_R = 0\text{ V}, T_{vj\text{start}} = 150\text{ °C},$ $t_p = 10\text{ ms}, \text{half-sinewave}$		14300	A
IGBT short circuit SOA	t_{psc}	$V_{CC} = 2500\text{ V}, V_{CEM\text{CHIP}} \leq 3300\text{ V}$ $V_{GE} \leq 15\text{ V}, T_{vj\text{start}} \leq 150\text{ °C}$		10	μs
Isolation voltage	V_{isol}	1 min, $f = 50\text{ Hz}$		6000	V
Junction temperature	T_{vj}			175	$^{\circ}\text{C}$
Junction operating temperature	$T_{vj(\text{op})}$		-40	150	$^{\circ}\text{C}$
Case temperature	T_C		-40	125	$^{\circ}\text{C}$
Storage temperature	T_{stg}		-50	125	$^{\circ}\text{C}$
Mounting torques ²⁾	M_s	Base-heatsink, M6 screws	4	6	Nm
	M_{t1}	Main terminals, M8 screws	8	10	
	M_{t2}	Auxiliary terminals, M4 screws	2	3	

¹⁾ Maximum rated values indicate limits beyond which damage to the device may occur per IEC 60747

²⁾ For detailed mounting instructions refer to Document No. 5SYA 2039

IGBT characteristic values ³⁾

Parameter	Symbol	Conditions	min	typ	max	Unit	
Collector (-emitter) breakdown voltage	$V_{(BR)CES}$	$V_{GE} = 0\text{ V}$, $I_C = 10\text{ mA}$	$T_{vj} = 150\text{ °C}$	3300		V	
			$T_{vj} = 25\text{ °C}$	3300			
			$T_{vj} = -40\text{ °C}$	3000			
Collector-emitter ⁴⁾ saturation voltage	V_{CEsat}	$I_C = 1800\text{ A}$, $V_{GE} = 15\text{ V}$	$T_{vj} = 25\text{ °C}$		2.3	2.7	V
			$T_{vj} = 125\text{ °C}$		2.75	3.2	
			$T_{vj} = 150\text{ °C}$		2.9		
Collector cut-off current	I_{CES}	$V_{CE} = 3300\text{ V}$, $V_{GE} = 0\text{ V}$	$T_{vj} = 25\text{ °C}$			1	mA
			$T_{vj} = 125\text{ °C}$		22		
			$T_{vj} = 150\text{ °C}$		120		
Gate leakage current	I_{GES}	$V_{CE} = 0\text{ V}$, $V_{GE} = \pm 20\text{ V}$, $T_{vj} = 125\text{ °C}$	-500		500	nA	
Gate-emitter threshold voltage	$V_{GE(TO)}$	$I_C = 240\text{ mA}$, $V_{CE} = V_{GE}$, $T_{vj} = 25\text{ °C}$	6.7		8.7	V	
Gate charge	Q_{ge}	$I_C = 1800\text{ A}$, $V_{CE} = 1800\text{ V}$, $V_{GE} = -15\text{ V} \dots 15\text{ V}$		18		μC	
Input capacitance	C_{ies}	$V_{CE} = 25\text{ V}$, $V_{GE} = 0\text{ V}$, $f = 1\text{ MHz}$, $T_{vj} = 25\text{ °C}$		239		nF	
Internal gate resistance	R_{Gint}			0.83		Ω	
Turn-on delay time	$t_{d(on)}$	$V_{CC} = 1800\text{ V}$, $I_C = 1800\text{ A}$, $R_G = 1.2\ \Omega$, $C_{GE} = 330\text{ nF}$, $V_{GE} = \pm 15\text{ V}$, $L_\sigma = 100\text{ nH}$, inductive load	$T_{vj} = 25\text{ °C}$		1120	ns	
			$T_{vj} = 150\text{ °C}$		1120		
Rise time	t_r		$T_{vj} = 25\text{ °C}$		310	ns	
			$T_{vj} = 150\text{ °C}$		320		
Turn-off delay time	$t_{d(off)}$	$V_{CC} = 1800\text{ V}$, $I_C = 1800\text{ A}$, $R_G = 4.7\ \Omega$, $C_{GE} = 330\text{ nF}$, $V_{GE} = \pm 15\text{ V}$, $L_\sigma = 100\text{ nH}$, inductive load	$T_{vj} = 25\text{ °C}$		2890	ns	
			$T_{vj} = 150\text{ °C}$		3470		
Fall time	t_f		$T_{vj} = 25\text{ °C}$		350	ns	
			$T_{vj} = 150\text{ °C}$		420		
Turn-on switching energy	E_{on}	$V_{CC} = 1800\text{ V}$, $I_C = 1800\text{ A}$, $R_G = 1.2\ \Omega$, $C_{GE} = 330\text{ nF}$, $V_{GE} = \pm 15\text{ V}$, $L_\sigma = 100\text{ nH}$, inductive load	$T_{vj} = 25\text{ °C}$		3.50	J	
			$T_{vj} = 125\text{ °C}$		4.30		
			$T_{vj} = 150\text{ °C}$		4.55		
Turn-off switching energy	E_{off}	$V_{CC} = 1800\text{ V}$, $I_C = 1800\text{ A}$, $R_G = 4.7\ \Omega$, $C_{GE} = 330\text{ nF}$, $V_{GE} = \pm 15\text{ V}$, $L_\sigma = 100\text{ nH}$, inductive load	$T_{vj} = 25\text{ °C}$		3.00	J	
			$T_{vj} = 125\text{ °C}$		4.00		
			$T_{vj} = 150\text{ °C}$		4.25		
Short circuit current	I_{sc}	$V_{CC} = 2500\text{ V}$, $V_{GE} = 15\text{ V}$	$T_{vj\text{ start}} = 150\text{ °C}$		6600	A	

³⁾ Characteristic values according to IEC 60747 – 9

⁴⁾ Collector-emitter saturation voltage is given at chip level

Diode characteristic values ⁵⁾

Parameter	Symbol	Conditions	min	typ	max	Unit	
Forward voltage ⁶⁾	V _F	I _F = 1800 A	T _{vj} = 25 °C	2.0	2.45	V	
			T _{vj} = 125 °C		2.2		2.65
			T _{vj} = 150 °C		2.15		
Peak reverse recovery current	I _{RM}		T _{vj} = 25 °C	2340		A	
			T _{vj} = 125 °C		2750		
			T _{vj} = 150 °C		3010		
Recovered charge	Q _{rr}	V _{CC} = 1800 V, I _F = 1800 A, V _{GE} = ±15 V, R _G = 1.2 Ω, C _{GE} = 330 nF, di/dt = 6.7 kA/μs, L _σ = 100 nH, inductive load	T _{vj} = 25 °C	1260		μC	
			T _{vj} = 125 °C		2060		
			T _{vj} = 150 °C		2400		
Reverse recovery time	t _{rr}		T _{vj} = 25 °C	850		ns	
			T _{vj} = 125 °C		1080		
			T _{vj} = 150 °C		1220		
Reverse recovery energy	E _{rec}		T _{vj} = 25 °C	1.40		J	
			T _{vj} = 125 °C		2.30		
			T _{vj} = 150 °C		2.60		

⁵⁾ Characteristic values according to IEC 60747 – 2

⁶⁾ Forward voltage is given at chip level

Package properties ⁷⁾

Parameter	Symbol	Conditions	min	typ	max	Unit	
IGBT thermal resistance junction to case	R _{th(j-c)IGBT}				0.009	K/W	
Diode thermal resistance junction to case	R _{th(j-c)DIODE}				0.014	K/W	
IGBT thermal resistance ²⁾ case to heatsink	R _{th(c-s)IGBT}	IGBT per switch, λ grease = 1W/m x K		0.007		K/W	
Diode thermal resistance ²⁾ case to heatsink	R _{th(c-s)DIODE}	Diode per switch, λ grease = 1W/m x K		0.010		K/W	
Partial discharge extinction voltage	V _e	f = 50 Hz, Q _{PD} ≤ 10 pC (acc. To IEC 61287)	2600			V	
Comparative tracking index	CTI		600				
Module stray inductance	L _{σ CE}			8		nH	
Resistance, terminal-chip	R _{CC+EE'}		T _C = 25 °C	0.055		mΩ	
			T _C = 125 °C		0.075		
			T _C = 150 °C		0.080		

²⁾ For detailed mounting instructions refer to Document No. 5SYA 2039

Mechanical properties ⁷⁾

Parameter	Symbol	Conditions	min	typ	max	Unit
Dimensions	L x W x H	Typical		190 x 140 x 38		mm
Clearance distance in air	d _a	according to IEC 60664-1 and EN 50124-1	Term. to base:	23		mm
			Term. to term:	19		
Surface creepage distance	d _s	according to IEC 60664-1 and EN 50124-1	Term. to base:	28.2		mm
			Term. to term:	28.2		
Mass	m			1190		g

⁷⁾ Package and mechanical properties according to IEC 60747 – 15

Electrical configuration

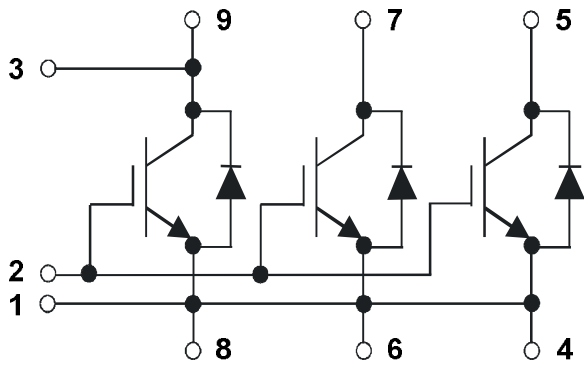

Outline drawing (mm)

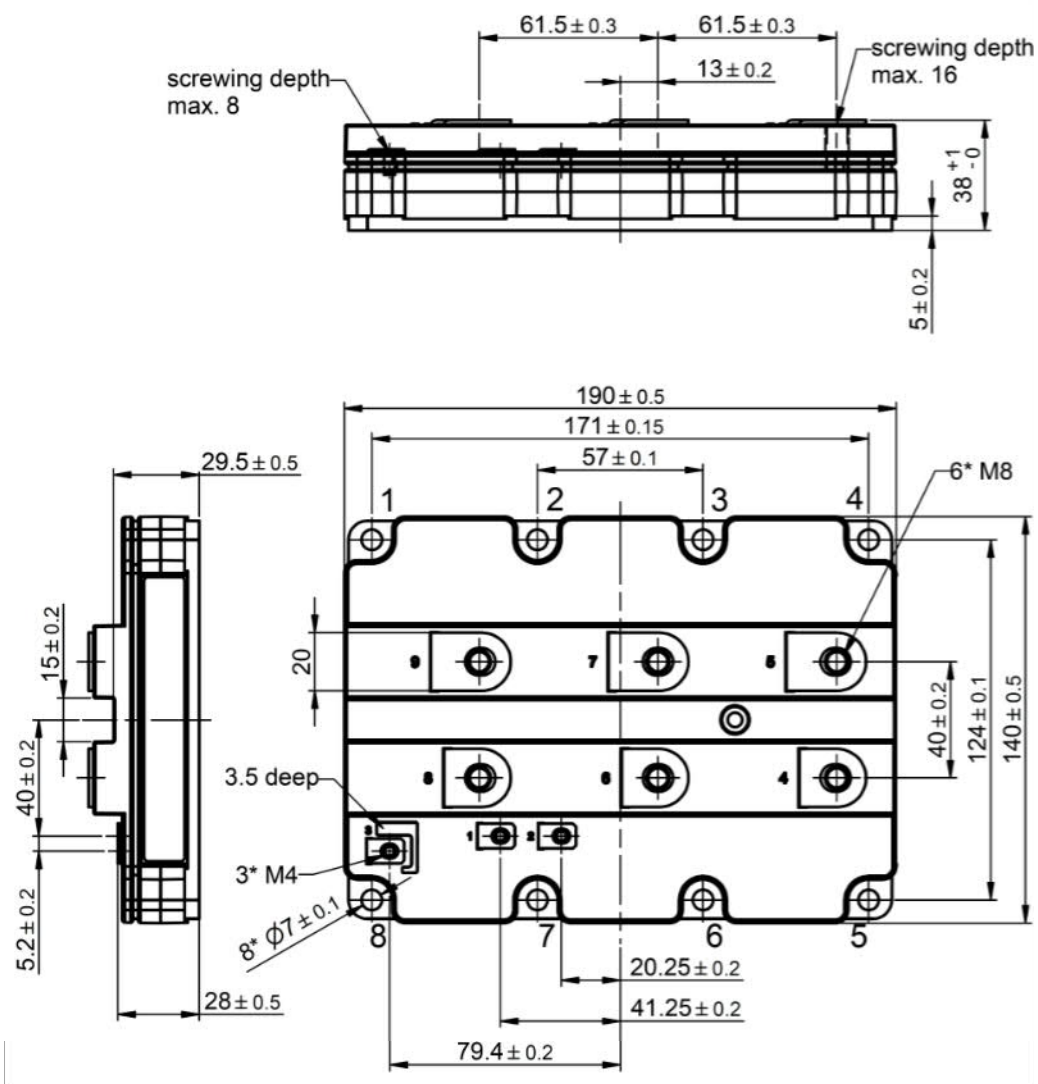

Note: This is an electrostatic sensitive device, please observe the international standard IEC 60747-1, chap. VIII. This product has been designed and qualified for Industrial Level.

Fig. 1 Typical on-state characteristics, chip level

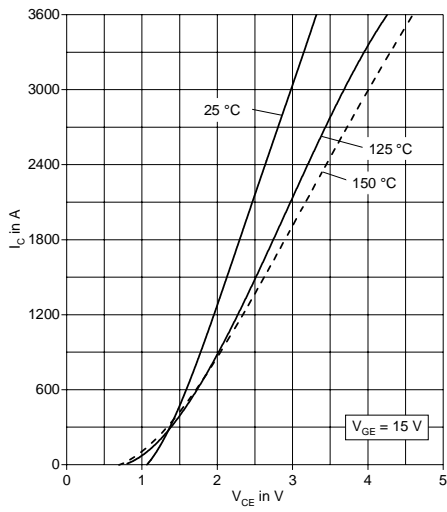

Fig. 2 Typical transfer characteristics, chip level

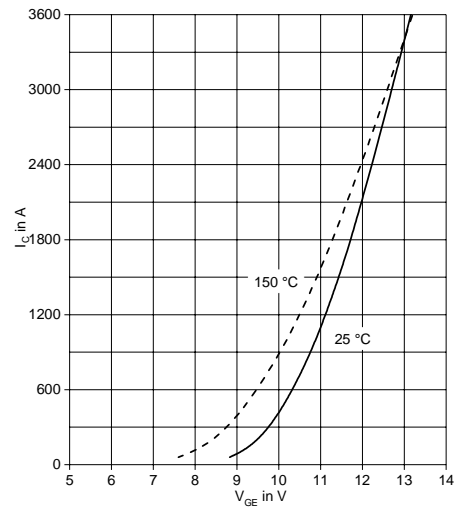

Fig. 3 Typical output characteristics, chip level

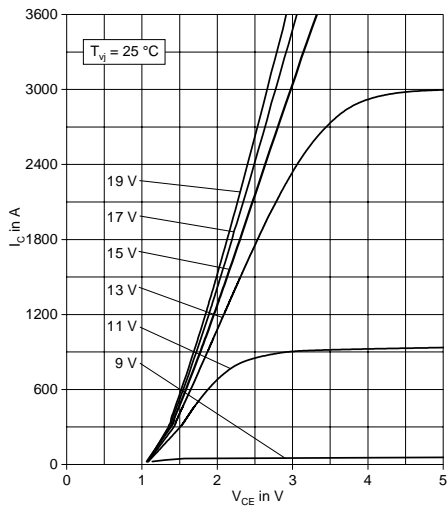

Fig. 4 Typical output characteristics, chip level

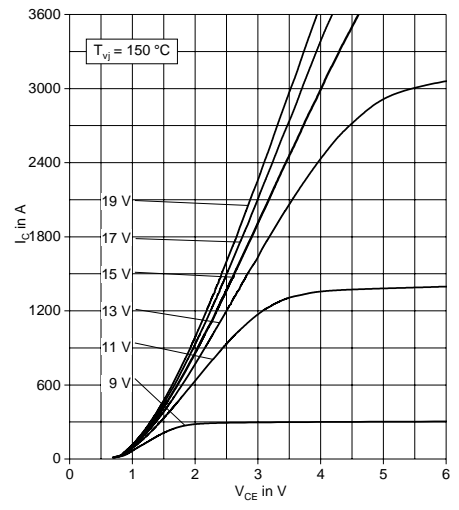

Fig. 5 Typical switching energies per pulse vs. collector current

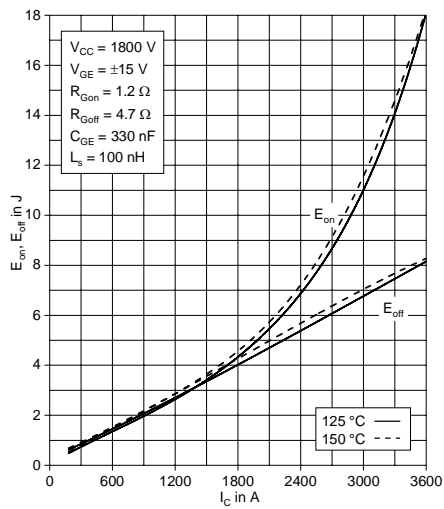

Fig. 6 Typical switching energies per pulse vs. gate resistor

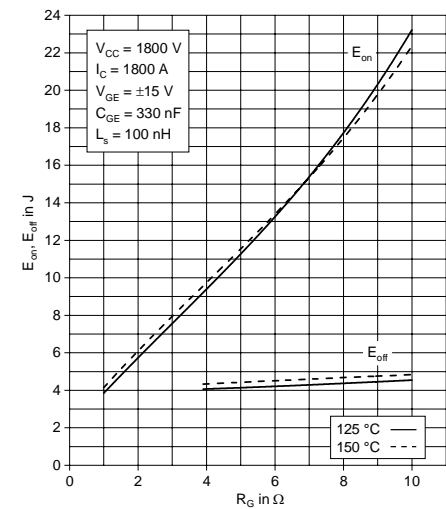

Fig. 7 Typical switching times vs. collector current

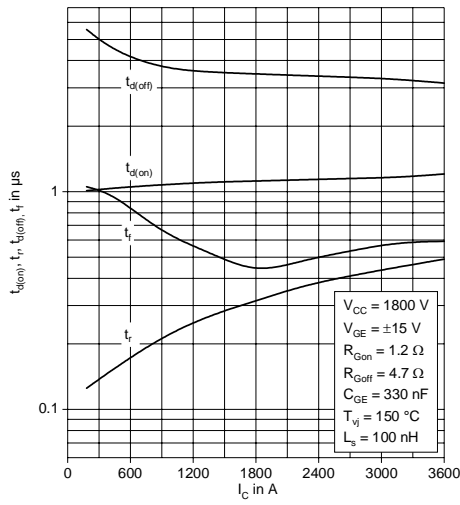

Fig. 8 Typical switching times vs. gate resistor

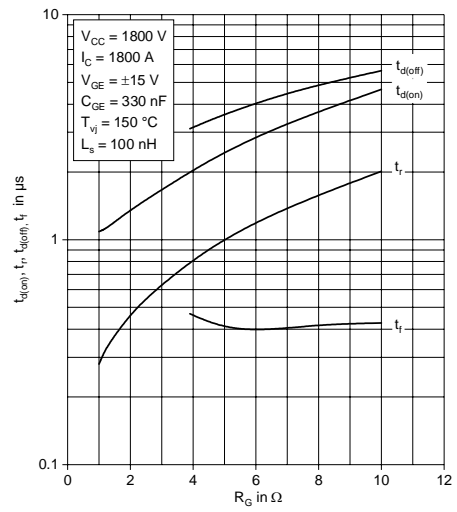

Fig. 9 Typical gate charge characteristics

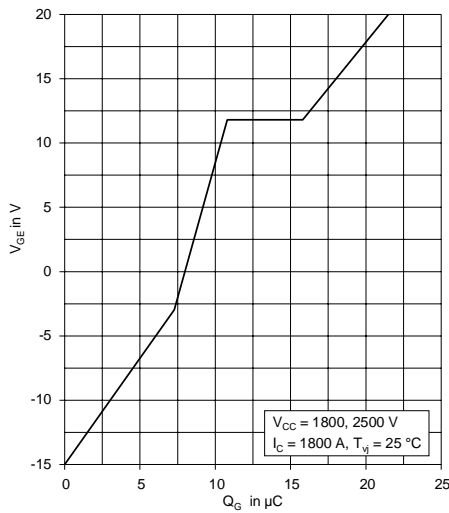

Fig. 10 Turn-off safe operating area (RBSOA)

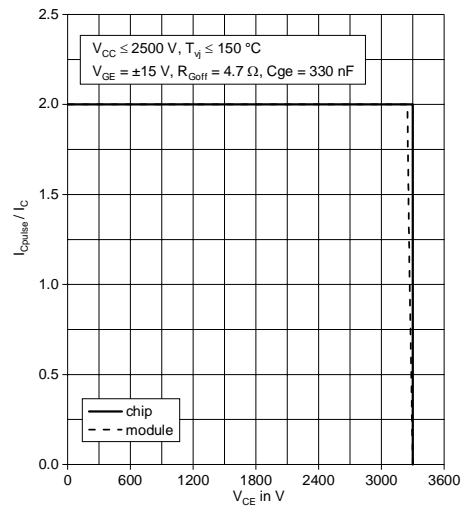

Fig. 11 Typical diode forward characteristics chip level

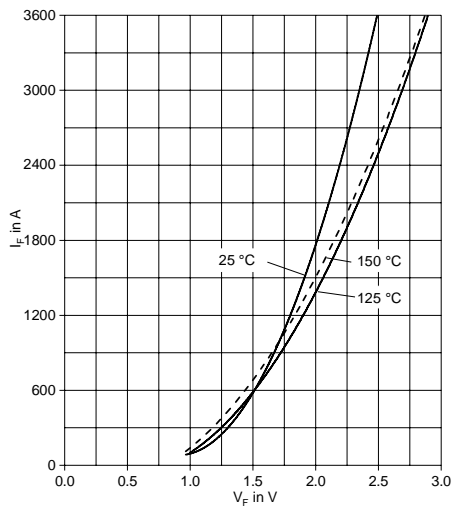

Fig. 12 Typical reverse recovery characteristics vs. forward current

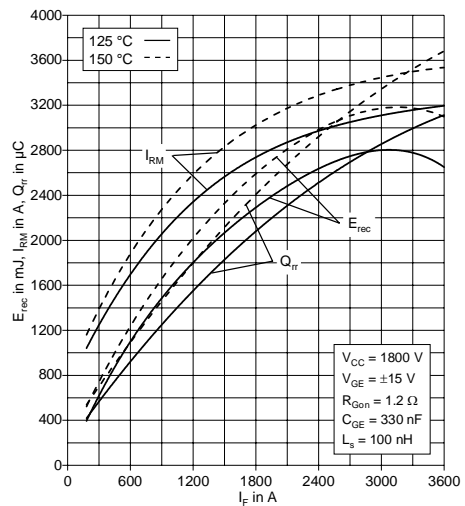

Fig. 13 Typical reverse recovery characteristics vs. di/dt

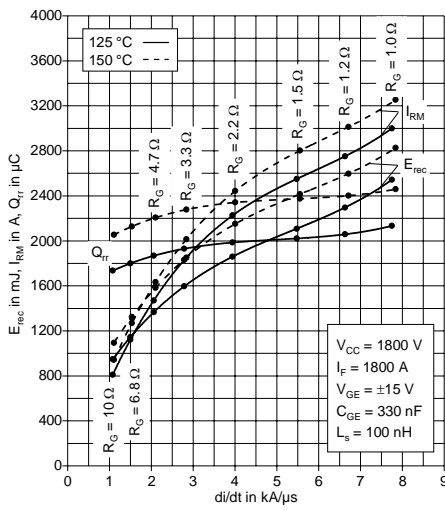

Fig. 14 Safe operating area diode (SOA)

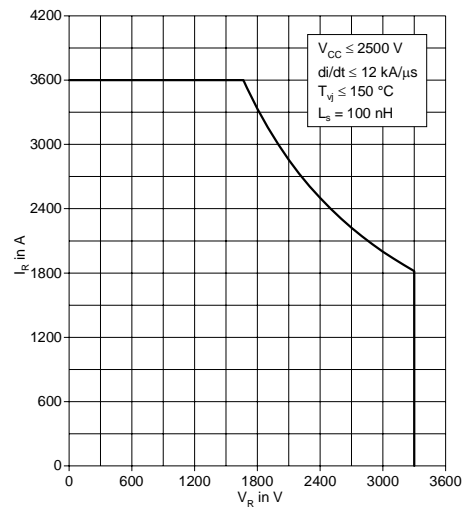
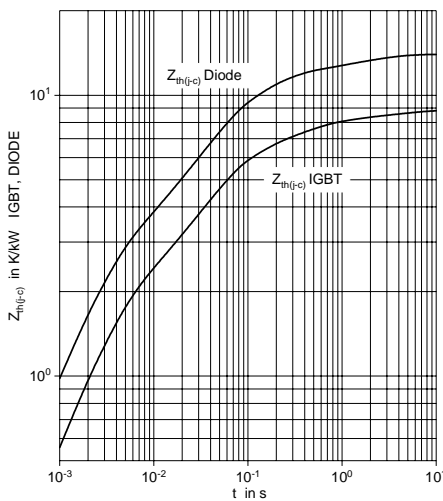

Fig. 15 Thermal impedance vs. time



Analytical function of the transient thermal resistance

$$Z_{th(j-c)}(t) = \sum_{i=1}^n R_i(1 - e^{-t/\tau_i})$$

	i	1	2	3	4	5
IGBT	R _i (K/kW)	1.631	4.286	2.089	0.855	
	τ _i (ms)	2.986	48.79	364.8	3593	
DIODE	R _i (K/kW)	2.441	4.23	5.055	2.253	
	τ _i (ms)	2.434	36.51	116.2	1641	

Related documents:

- 5SYA 2039 Mounting Instructions for HiPak modules
- 5SYA 2042 Failure rates of IGBT modules due to cosmic rays
- 5SYA 2043 Load – cycle capability of HiPaks
- 5SYA 2045 Thermal runaway during blocking
- 5SYA 2053 Applying IGBT
- 5SYA 2057 IGBT diode safe operating area (SOA)
- 5SYA 2058 Surge currents for IGBT diodes
- 5SYA 2093 Thermal design of IGBT modules
- 5SYA 2098 Paralleling of IGBT modules

