

Stanilite®

Signature flood light LED



Range

Signature range

Product group

Flood light LED



Features

- 3 year warranty
- LED technology 100,000 hours lamp life
- Light output typically 600 lumens per lamp head
- Beam angle 120° flood
- Lamp heads can be rotated and tilted to suit particular installation requirements
- Easy to maintain and low maintenance cost
- Wall mounting

Catalogue no.	Description
EM products	
FL210LED	LED flood light 2x10W 12V
Spare parts	
14-00061	Battery sealed lead acid 12V 7Ah
15-10027	LED lamp 10W 12V

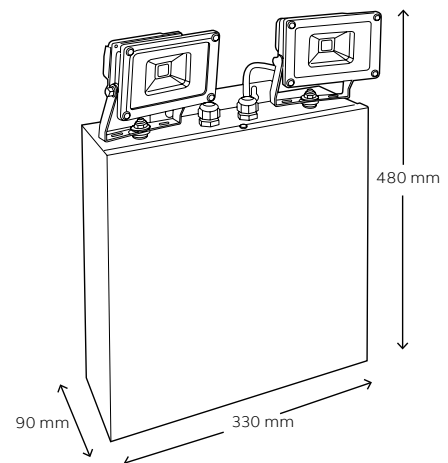

Dimensions			
	Width	Height	Depth
	330mm	480mm	90mm

Weight	
Model	Weight
Standard	8.5kg

Construction	
Part	Construction
Body and cover	White powder coated zinc steel
Lamp head	Diecast aluminium and steel bracket, white powder coated. Glass lens

Light source	
Model	Light source
Standard	LED 10W

Power consumption	
Model	Power consumption
Standard	6.8W ^

^Nominal power. The above input power can vary, depending on the mains input voltage, SLA battery charge status and ambient temperature.

Photometrics

The photometric data below is calculated for a LED flood light mounted at 3 metres, 4 metres and 5 metres. The lamp head must be positioned and aimed as shown in the drawings below.

1x10W LED flood light Tilt 50°

Mounted 3m AFL

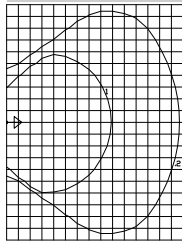

Mounted 4m AFL

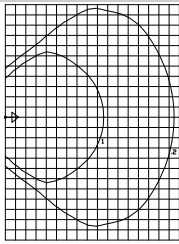

Mounted 5m AFL

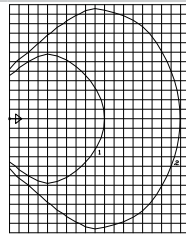

2x10W LED flood light Tilt 50°

Mounted 3m AFL

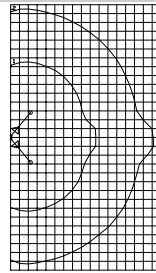

Mounted 4m AFL

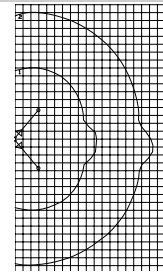

Mounted 5m AFL

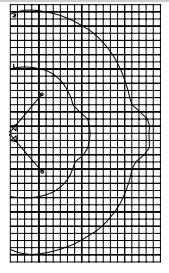

Area coverage 0.2 lux min

200m²

265m²

320m²

340m²

420m²

500m²

Area coverage 1.0 lux min

85m²

95m²

105m²

123m²

143m²

160m²

Note:

- The outer line represents 0.2 lux and inner line 1.0 lux
- Gridlines are 1 metre spacing
- AFL = Above Floor Level

Note:

- Designed to comply with AS2293 and meet relevant Australian EMC standards